

THE 394 MAGNETIC ROD GROUP TYPES

Diagrams of symmetry elements and of the general position

Origin

Asymmetric unit

Symmetry operations

Generators selected

Positions

Symmetry of special projections

Go to Title Page

Magnetic Rod Group Index

1.1.1	$p1$	6.5.24	$p2'/m11$
1.2.2	$p11'$	6.6.25	$p_{2c}2'/m'11$
1.3.3	$p_{2c}1$	6.7.26	$p_{2c}2/m11$
2.1.4	$p\bar{1}$	7.1.27	$p2/c11$
2.2.5	$p\bar{1}1'$	7.2.28	$p2/c111'$
2.3.6	$p\bar{1}'$	7.3.29	$p2/c'11$
2.4.7	$p_{2c}\bar{1}$	7.4.30	$p2'/c'11$
3.1.8	$p211$	7.5.31	$p2'/c11$
3.2.9	$p2111'$	8.1.32	$p112$
3.3.10	$p2'11$	8.2.33	$p1121'$
3.4.11	$p_{2c}211$	8.3.34	$p112'$
4.1.12	$pm11$	8.4.35	$p_{2c}112'$
4.2.13	$pm111'$	8.5.36	$p_{2c}112$
4.3.14	$pm'11$	9.1.37	$p112_1$
4.4.15	$p_{2c}m'11$	9.2.38	$p112_11'$
4.5.16	$p_{2c}m11$	9.3.39	$p112_1'$
5.1.17	$pc11$	10.1.40	$p11m$
5.2.18	$pc111'$	10.2.41	$p11m1'$
5.3.19	$pc'11$	10.3.42	$p11m'$
6.1.20	$p2/m11$	10.4.43	$p_{2c}11m$
6.2.21	$p2/m111'$	11.1.44	$p112/m$
6.3.22	$p2/m'11$	11.2.45	$p112/m1'$
6.4.23	$p2'/m'11$	11.3.46	$p112/m'$

11.4.47	$p112'/m'$	15.7.72	$p_{2c}mm2$
11.5.48	$p112'/m$		
11.6.49	$p_{2c}112'/m'$	16.1.73	$pcc2$
11.7.50	$p_{2c}112/m$	16.2.74	$pcc21'$
		16.3.75	$pc'c'2$
12.1.51	$p112_1/m$	16.4.76	$pcc'2'$
12.2.52	$p112_1/m1'$		
12.3.53	$p112_1/m'$	17.1.77	$pmc2_1$
12.4.54	$p112_1'/m'$	17.2.78	$pmc2_11'$
12.5.55	$p112_1'/m$	17.3.79	$pm'c'2_1$
		17.4.80	$pm'c2_1'$
13.1.56	$p222$	17.5.81	$pmc'2_1'$
13.2.57	$p2221'$		
13.3.58	$p22'2'$	18.1.82	$p2mm$
13.4.59	$p2'2'2$	18.2.83	$p2mm1'$
13.5.60	$p_{2c}22'2'$	18.3.84	$p2m'm'$
13.6.61	$p_{2c}222$	18.4.85	$p2'm'm$
		18.5.86	$p2'mm'$
14.1.62	$p222_1$	18.6.87	$p_{2c}2m'm'$
14.2.63	$p222_11'$	18.7.88	$p_{2c}2mm$
14.3.64	$p2'2'2_1$		
14.4.65	$p22'2_1'$	19.1.89	$p2cm$
		19.2.90	$p2cm1'$
15.1.66	$pmm2$	19.3.91	$p2c'm'$
15.2.67	$pmm21'$	19.4.92	$p2'cm'$
15.3.68	$pm'm'2$	19.5.93	$p2'c'm$
15.4.69	$pmm'2'$		
15.5.70	$p_{2c}m'm'2$	20.1.94	$pmmm$
15.6.71	$p_{2c}mm'2'$	20.2.95	$pmmm1'$

20.3.96	$pm'm'm'$	23.2.121	$p41'$
20.4.97	$pm'm'm$	23.3.122	$p4'$
20.5.98	$pmm'm'$	23.4.123	$p_{2c}4'$
20.6.99	$pmmm'$	23.5.124	$p_{2c}4$
20.7.100	$pm'mm$	24.1.125	$p4_1$
20.8.101	$p_{2c}m'm'm$	24.2.126	$p4_11'$
20.9.102	$p_{2c}mm'm'$	24.3.127	$p4_1'$
20.10.103	$p_{2c}mmm$	25.1.128	$p4_2$
21.1.104	$pccm$	25.2.129	$p4_21'$
21.2.105	$pccm1'$	25.3.130	$p4_2'$
21.3.106	$pc'c'm'$	25.4.131	$p_{2c}4_2$
21.4.107	$pc'c'm$	25.5.132	$p_{2c}4_2'$
21.5.108	$pcc'm'$	26.1.133	$p4_3$
21.6.109	$pccm'$	26.2.134	$p4_31'$
21.7.110	$pc'cm$	26.3.135	$p4_3'$
22.1.111	$pmcm$	27.1.136	$p\bar{4}$
22.2.112	$pmcm1'$	27.2.137	$p\bar{4}1'$
22.3.113	$pm'c'm'$	27.3.138	$p\bar{4}'$
22.4.114	$pm'cm'$	27.4.139	$p_{2c}\bar{4}$
22.5.115	$pmc'm'$	28.1.140	$p4/m$
22.6.116	$pm'c'm$	28.2.141	$p4/m1'$
22.7.117	$pmc'm$	28.3.142	$p4/m'$
22.8.118	$pm'cm$	28.4.143	$p4'/m'$
22.9.119	$pmcm'$	28.5.144	$p4'/m$
23.1.120	$p4$		

28.6.145	$p_{2c}4'/m$	33.2.169	$p4_3221'$
28.7.146	$p_{2c}4/m$	33.3.170	$p4_32'2'$
29.1.147	$p4_2/m$	33.4.171	$p4_3'22'$
29.2.148	$p4_2/m1'$	34.1.172	$p4mm$
29.3.149	$p4_2/m'$	34.2.173	$p4mm1'$
29.4.150	$p4_2'/m'$	34.3.174	$p4m'm'$
29.5.151	$p4_2'/m$	34.4.175	$p4'mm'$
30.1.152	$p422$	34.5.176	$p_{2c}4m'm'$
30.2.153	$p4221'$	34.6.177	$p_{2c}4'm'm$
30.3.154	$p42'2'$	34.7.178	$p_{2c}4mm$
30.4.155	$p4'22'$	35.1.179	$p4_2cm$
30.5.156	$p_{2c}4'22'$	35.2.180	$p4_2cm1'$
30.6.157	$p_{2c}422$	35.3.181	$p4_2c'm'$
31.1.158	$p4_122$	35.4.182	$p4_2'cm'$
31.2.159	$p4_1221'$	35.5.183	$p4_2'c'm$
31.3.160	$p4_12'2'$	36.1.184	$p4cc$
31.4.161	$p4_1'22'$	36.2.185	$p4cc1'$
32.1.162	$p4_222$	36.3.186	$p4c'c'$
32.2.163	$p4_2221'$	36.4.187	$p4'cc'$
32.3.164	$p4_22'2'$	37.1.188	$p\bar{4}2m$
32.4.165	$p4_2'22'$	37.2.189	$p\bar{4}2m1'$
32.5.166	$p_{2c}4_222$	37.3.190	$p\bar{4}2'm'$
32.6.167	$p_{2c}4_2'22'$	37.4.191	$p\bar{4}'2m'$
33.1.168	$p4_322$	37.5.192	$p\bar{4}'2'm$

37.6.193	$\rho_{2c}\bar{4}2'm'$	41.1.217	$\rho 4_2/mmc$
37.7.194	$\rho_{2c}\bar{4}2m$	41.2.218	$\rho 4_2/mmc1'$
38.1.195	$\rho\bar{4}2c$	41.3.219	$\rho 4_2/m'm'c'$
38.2.196	$\rho\bar{4}2c1'$	41.4.220	$\rho 4_2/mm'c'$
38.3.197	$\rho\bar{4}2'c'$	41.5.221	$\rho 4_2/m'mc$
38.4.198	$\rho\bar{4}'2c'$	41.6.222	$\rho 4_2'/m'mc'$
38.5.199	$\rho\bar{4}'2'c$	41.7.223	$\rho 4_2'/m'm'c$
39.1.200	$\rho 4/mmm$	41.8.224	$\rho 4_2'/mmc'$
39.2.201	$\rho 4/mmm1'$	41.9.225	$\rho 4_2'/mm'c$
39.3.202	$\rho 4/m'm'm'$	42.1.226	$\rho 3$
39.4.203	$\rho 4/mm'm'$	42.2.227	$\rho 31'$
39.5.204	$\rho 4/m'mm$	42.3.228	$\rho_{2c}3$
39.6.205	$\rho 4'/m'm'm$	43.1.229	$\rho 3_1$
39.7.206	$\rho 4'/mmm'$	43.2.230	$\rho 3_11'$
39.8.207	$\rho_{2c}4/mm'm'$	43.3.231	$\rho_{2c}3_2$
39.9.208	$\rho_{2c}4'/mmm'$	44.1.232	$\rho 3_2$
39.10.209	$\rho_{2c}4/mmm$	44.2.233	$\rho 3_21'$
40.1.210	$\rho 4/mcc$	44.3.234	$\rho_{2c}3_1$
40.2.211	$\rho 4/mcc1'$	45.1.235	$\rho\bar{3}$
40.3.212	$\rho 4/m'c'c'$	45.2.236	$\rho\bar{3}1'$
40.4.213	$\rho 4/mc'c'$	45.3.237	$\rho\bar{3}'$
40.5.214	$\rho 4/m'cc$	45.4.238	$\rho_{2c}\bar{3}$
40.6.215	$\rho 4'/m'c'c$	46.1.239	$\rho 312$
40.7.216	$\rho 4'/mcc'$	46.2.240	$\rho 3121'$

46.3.241	$p312'$	51.7.265	$p_{2c}\bar{3}1m$
46.4.242	$p_{2c}312$	52.1.266	$p\bar{3}1c$
47.1.243	$p3_112$	52.2.267	$p\bar{3}1c1'$
47.2.244	$p3_1121'$	52.3.268	$p\bar{3}'1c'$
47.3.245	$p3_112'$	52.4.269	$p\bar{3}1c'$
47.4.246	$p_{2c}3_212$	52.5.270	$p\bar{3}'1c$
48.1.247	$p3_212$	53.1.271	$p6$
48.2.248	$p3_2121'$	53.2.272	$p61'$
48.3.249	$p3_212'$	53.3.273	$p6'$
48.4.250	$p_{2c}3_112$	53.4.274	$p_{2c}6'$
49.1.251	$p3m1$	53.5.275	$p_{2c}6$
49.2.252	$p3m1'$	54.1.276	$p6_1$
49.3.253	$p3m'1$	54.2.277	$p6_11'$
49.4.254	$p_{2c}3m'1$	54.3.278	$p6_1'$
49.5.255	$p_{2c}3m1$	55.1.279	$p6_2$
50.1.256	$p3c1$	55.2.280	$p6_21'$
50.2.257	$p3c11'$	55.3.281	$p6_2'$
50.3.258	$p3c'1$	55.4.282	$p_{2c}6_2$
		55.5.283	$p_{2c}6_2'$
51.1.259	$p\bar{3}1m$	56.1.284	$p6_3$
51.2.260	$p\bar{3}1m1'$	56.2.285	$p6_31'$
51.3.261	$p\bar{3}'1m'$	56.3.286	$p6_3'$
51.4.262	$p\bar{3}1m'$		
51.5.263	$p\bar{3}'1m$	57.1.287	$p6_4$
51.6.264	$p_{2c}\bar{3}1m'$	57.2.288	$p6_41'$

57.3.289	$p6_4'$	62.3.313	$p62'2'$
57.4.290	$p_{2c}6_4'$	62.4.314	$p6'2'2$
57.5.291	$p_{2c}6_4$	62.5.315	$p_{2c}6'22'$
58.1.292	$p6_5$	62.6.316	$p_{2c}622$
58.2.293	$p6_51'$	63.1.317	$p6_122$
58.3.294	$p6_5'$	63.2.318	$p6_1221'$
59.1.295	$p\bar{6}$	63.3.319	$p6_12'2'$
59.2.296	$p\bar{6}1'$	63.4.320	$p6_1'2'2$
59.3.297	$p\bar{6}'$	64.1.321	$p6_222$
59.4.298	$p_{2c}\bar{6}$	64.2.322	$p6_2221'$
60.1.299	$p6/m$	64.3.323	$p6_22'2'$
60.2.300	$p6/m1'$	64.4.324	$p6_2'2'2$
60.3.301	$p6/m'$	64.5.325	$p_{2c}6_222$
60.4.302	$p6'/m'$	64.6.326	$p_{2c}6_2'22'$
60.5.303	$p6'/m$	65.1.327	$p6_322$
60.6.304	$p_{2c}6'/m'$	65.2.328	$p6_3221'$
60.7.305	$p_{2c}6/m$	65.3.329	$p6_32'2'$
61.1.306	$p6_3/m$	65.4.330	$p6_3'2'2$
61.2.307	$p6_3/m1'$	66.1.331	$p6_422$
61.3.308	$p6_3/m'$	66.2.332	$p6_4221'$
61.4.309	$p6_3'/m'$	66.3.333	$p6_42'2'$
61.5.310	$p6_3'/m$	66.4.334	$p6_4'2'2$
62.1.311	$p622$	66.5.335	$p_{2c}6_4'22'$
62.2.312	$p6221'$	66.6.336	$p_{2c}6_422$

67.1.337	$p6_522$	71.6.362	$p_{2c}\bar{6}m'2'$
67.2.338	$p6_5221'$	71.7.363	$p_{2c}\bar{6}m2$
67.3.339	$p6_52'2'$	72.1.364	$p\bar{6}c2$
67.4.340	$p6_5'2'2$	72.2.365	$p\bar{6}c21'$
68.1.341	$p6mm$	72.3.366	$p\bar{6}c'2'$
68.2.342	$p6mm1'$	72.4.367	$p\bar{6}'c2'$
68.3.343	$p6m'm'$	72.5.368	$p\bar{6}'c'2$
68.4.344	$p6'mm'$	73.1.369	$p6/mmm$
68.5.345	$p_{2c}6m'm'$	73.2.370	$p6/mmm1'$
68.6.346	$p_{2c}6'mm'$	73.3.371	$p6/m'm'm'$
68.7.347	$p_{2c}6mm$	73.4.372	$p6/mm'm'$
69.1.348	$p6cc$	73.5.373	$p6/m'mm$
69.2.349	$p6cc1'$	73.6.374	$p6'/m'm'm$
69.3.350	$p6c'c'$	73.7.375	$p6'/mmm'$
69.4.351	$p6'cc'$	73.8.376	$p_{2c}6/mm'm'$
70.1.352	$p6_3mc$	73.9.377	$p_{2c}6'/m'mm'$
70.2.353	$p6_3mc1'$	73.10.378	$p_{2c}6/mmm$
70.3.354	$p6_3m'c'$	74.1.379	$p6/mcc$
70.4.355	$p6_3'mc'$	74.2.380	$p6/mcc1'$
70.5.356	$p6_3'm'c$	74.3.381	$p6/m'c'c'$
71.1.357	$p\bar{6}m2$	74.4.382	$p6/mc'c'$
71.2.358	$p\bar{6}m21'$	74.5.383	$p6/m'cc$
71.3.359	$p\bar{6}m'2'$	74.6.384	$p6'/m'c'c$
71.4.360	$p\bar{6}'m2'$	74.7.385	$p6'/mcc'$
71.5.361	$p\bar{6}'m'2$	75.1.386	$p6_3/mmc$

75.2.387	$\rho 6_3/mmc1'$
75.3.388	$\rho 6_3/m'm'c'$
75.4.389	$\rho 6_3/mm'c'$
75.5.390	$\rho 6_3/m'mc$
75.6.391	$\rho 6_3'/m'mc'$
75.7.392	$\rho 6_3'/m'm'c$
75.8.393	$\rho 6_3'/mmc'$
75.9.394	$\rho 6_3'/mm'c$

$p1$

1

Triclinic

No. 1.1.1

$p1$

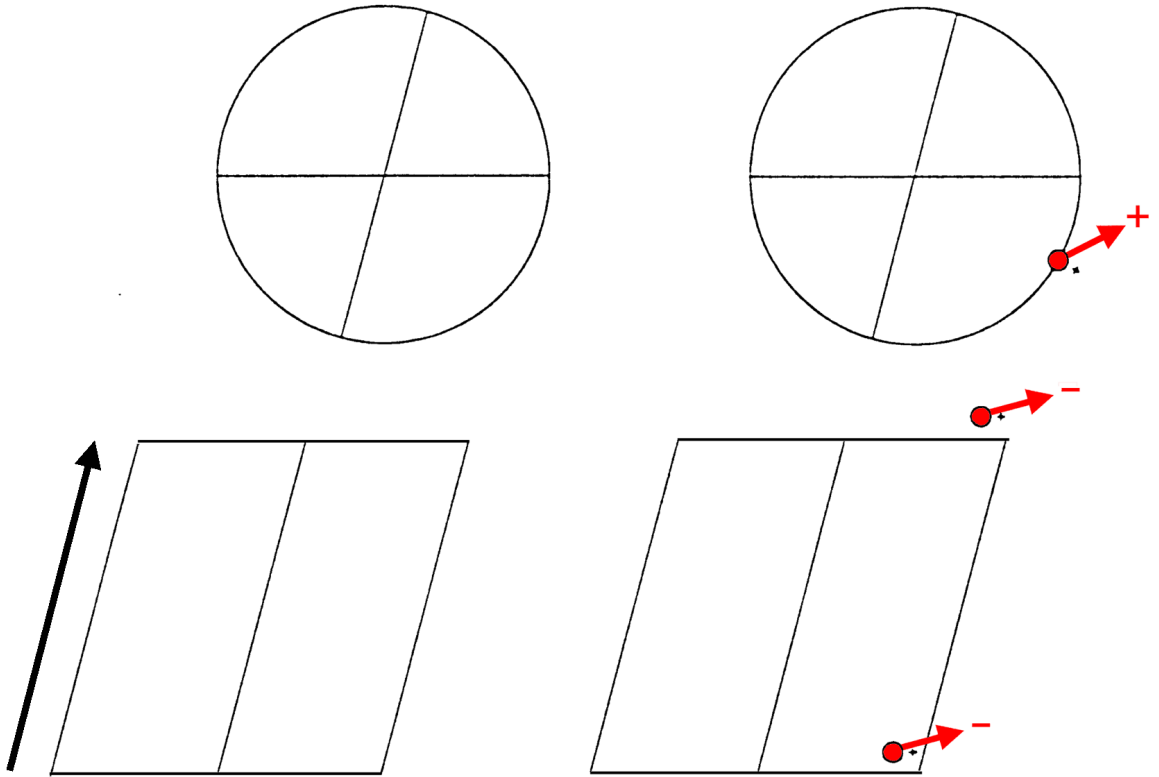

Origin arbitrary

Asymmetric unit $0 \leq z \leq 1$

Symmetry operations

(1) 1
(1|0,0,0)

Continued

No. 1.1.1

*p*1

Generators selected (1); $t(0,0,1)$

Positions

	Coordinates
Multiplicity, Wyckoff letter, Site symmetry	

1 a 1	(1) x,y,z [u,v,w]
-------	-------------------

Symmetry of special projections

Along [001] 1	Along [100] <i>p</i> 1	Along [010] <i>p</i> 1
Origin at 0,0,z	$a^* = c_p$ Origin at x,0,0	$a^* = c_p$ Origin at 0,y,0

$p11'$

No. 1.2.2

$1'$

$p11'$

Triclinic

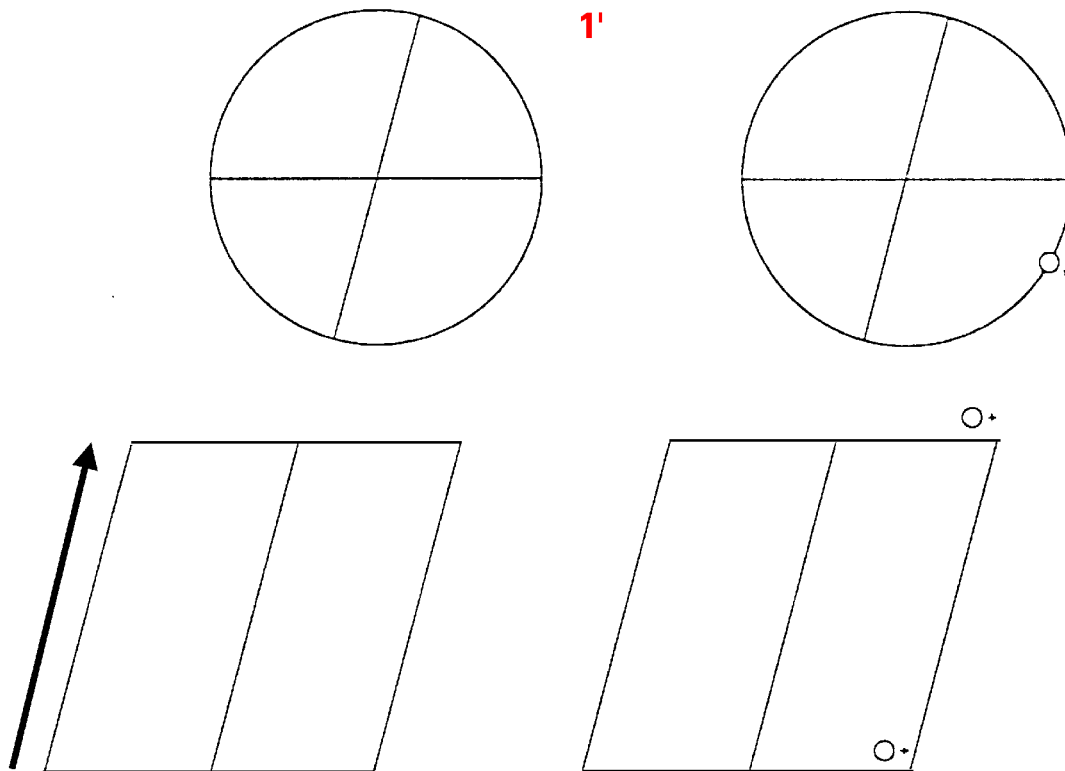

Origin arbitrary

Asymmetric unit $0 \leq z \leq 1$

Symmetry operations

For 1 + set
(1) 1
(1|0,0,0)

For $1'$ + set
(1) $1'$
(1|0,0,0)'

Continued

No. 1.2.2

$p11'$

Generators selected (1); $t(0,0,1)$; $1'$

Positions

Multiplicity, Wyckoff letter, Site symmetry	Coordinates	
	$1+$	$1'+$
1 a $11'$	(1) x,y,z	[0,0,0]

Symmetry of special projections

Along [001] $11'$	Along [100] $p11'$	Along [010] $p11'$
Origin at 0,0,z	$a^* = c_p$ Origin at x,0,0	$a^* = c_p$ Origin at 0,y,0

$\rho_{2c}1$

$1'$

Triclinic

No. 1.3.3

$\rho_{2c}1$

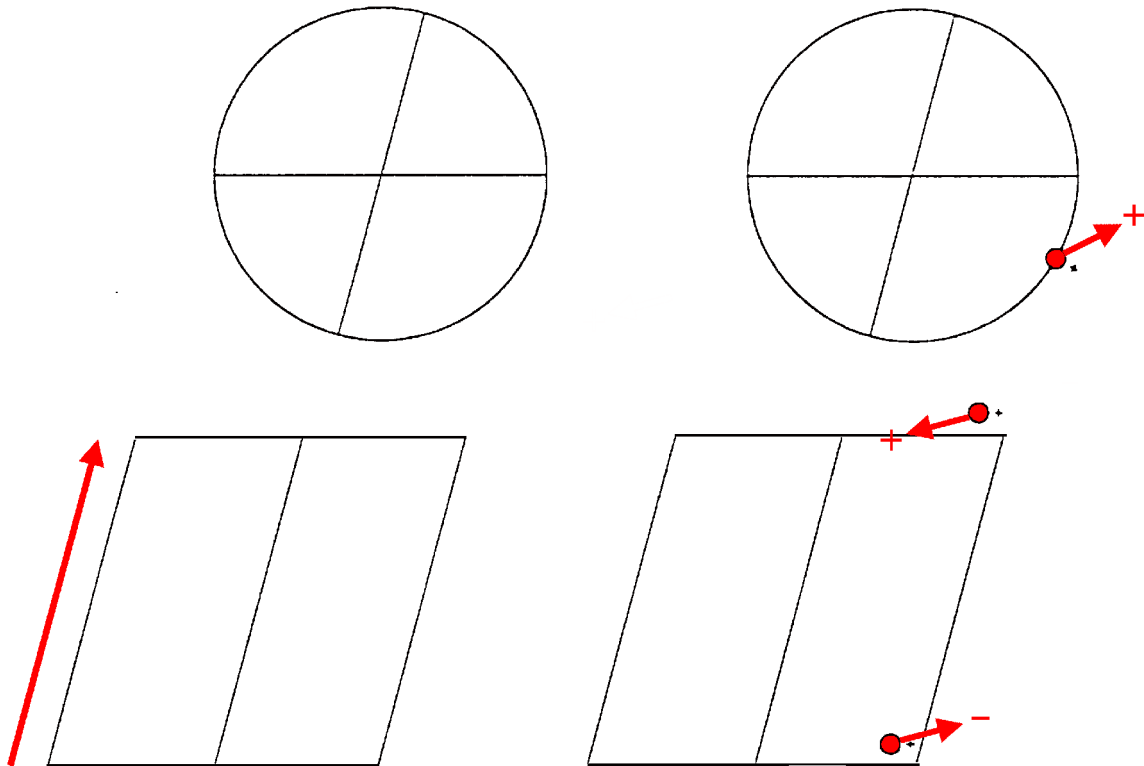

Origin arbitrary

Asymmetric unit $0 \leq z \leq 1$

Symmetry operations

For $(0,0,0) +$ set
(1) 1
(1| $0,0,0$)

For $(0,0,1)'$ + set
(1) $t'(0,0,1)$
(1| $0,0,1$)'

Continued

No. 1.3.3

$p_{2c}1$

Generators selected (1); $t(0,0,1)'$

Positions

Multiplicity,
Wyckoff letter,
Site symmetry

Coordinates

$(0,0,0)+$ $(0,0,1)'+$

1 a 1 (1) x,y,z [u,v,w]

Symmetry of special projections

Along [001] $11'$

Along [100] $p_{2a^*}1$

Along [010] $p_{2a^*}1$

Origin at 0,0,z

$a^* = c_p$
Origin at x,0,0

$a^* = c_p$
Origin at 0,y,0

$p\bar{1}$

$\bar{1}$

Triclinic

No. 2.1.4

$p\bar{1}$

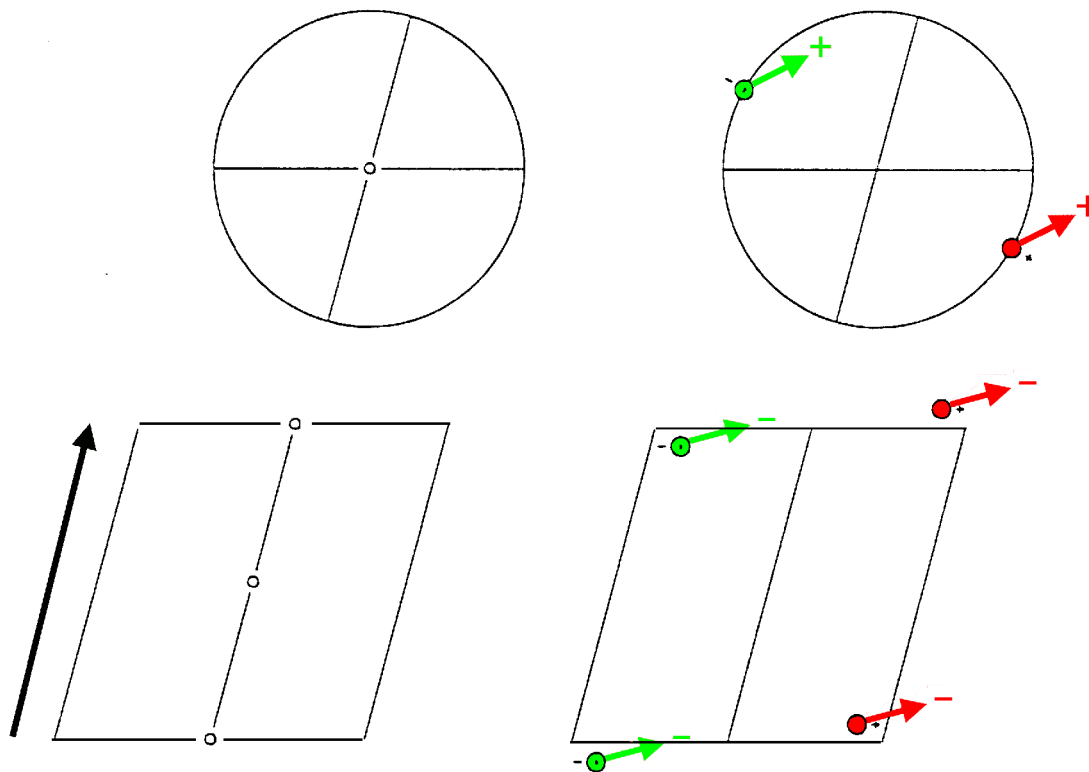

Origin at $\bar{1}$

Asymmetric unit $0 \leq z \leq 1/2$

Symmetry operations

- (1) 1
- (2) $\bar{1}$ $0,0,0$
- (1|0,0,0) ($\bar{1}$ |0,0,0)

Generators selected (1); $t(0,0,1)$; (2)

Positions

Multiplicity, Wyckoff letter, Site symmetry	Coordinates	
	(1) x,y,z [u,v,w]	(2) \bar{x},\bar{y},\bar{z} [u,v,w]
2 c $\bar{1}$	(1) x,y,z [u,v,w]	(2) \bar{x},\bar{y},\bar{z} [u,v,w]
1 b $\bar{1}$	0,0,1/2 [u,v,w]	
1 a $\bar{1}$	0,0,0 [u,v,w]	

Symmetry of special projections

Along [001] $2'11$	Along [100] $p2'11$	Along [010] $p2'11$
Origin at 0,0,z	$a^* = c_p$ Origin at x,0,0	$a^* = c_p$ Origin at 0,y,0

$p\bar{1}1'$

$\bar{1}1'$

Triclinic

No. 2.2.5

$p\bar{1}1'$

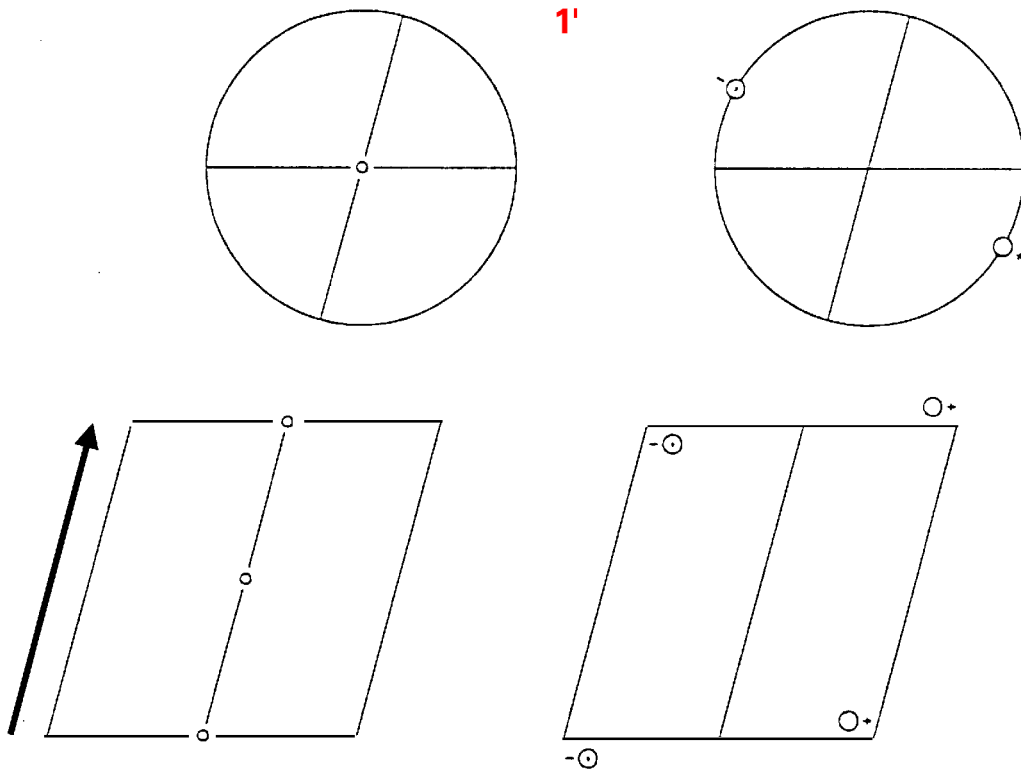

Origin at $\bar{1}1'$

Asymmetric unit $0 \leq z \leq 1/2$

Symmetry operations

For 1 + set

(1) 1	(2) $\bar{1}$ 0,0,0
(1 0,0,0)	($\bar{1}$ 0,0,0)

For 1' + set

(1) 1'	(2) $\bar{1}'$ 0,0,0
(1 0,0,0)'	($\bar{1}'$ 0,0,0)'

Generators selected (1); $t(0,0,1)$; (2); $1'$

Positions

Multiplicity, Wyckoff letter, Site symmetry	Coordinates	
	$1+$	$1'+$
2 c $11'$	(1) x,y,z [0,0,0]	(2) \bar{x},\bar{y},\bar{z} [0,0,0]
1 b $\bar{1}1'$	0,0,1/2 [0,0,0]	
1 a $\bar{1}1'$	0,0,0 [0,0,0]	

Symmetry of special projections

Along [001] $2111'$	Along [100] $p2111'$	Along [010] $p2111'$
Origin at 0,0,z	$a^* = c_p$ Origin at x,0,0	$a^* = c_p$ Origin at 0,y,0

$p\bar{1}$

No. 2.3.6

$\bar{1}$

$p\bar{1}$

Triclinic

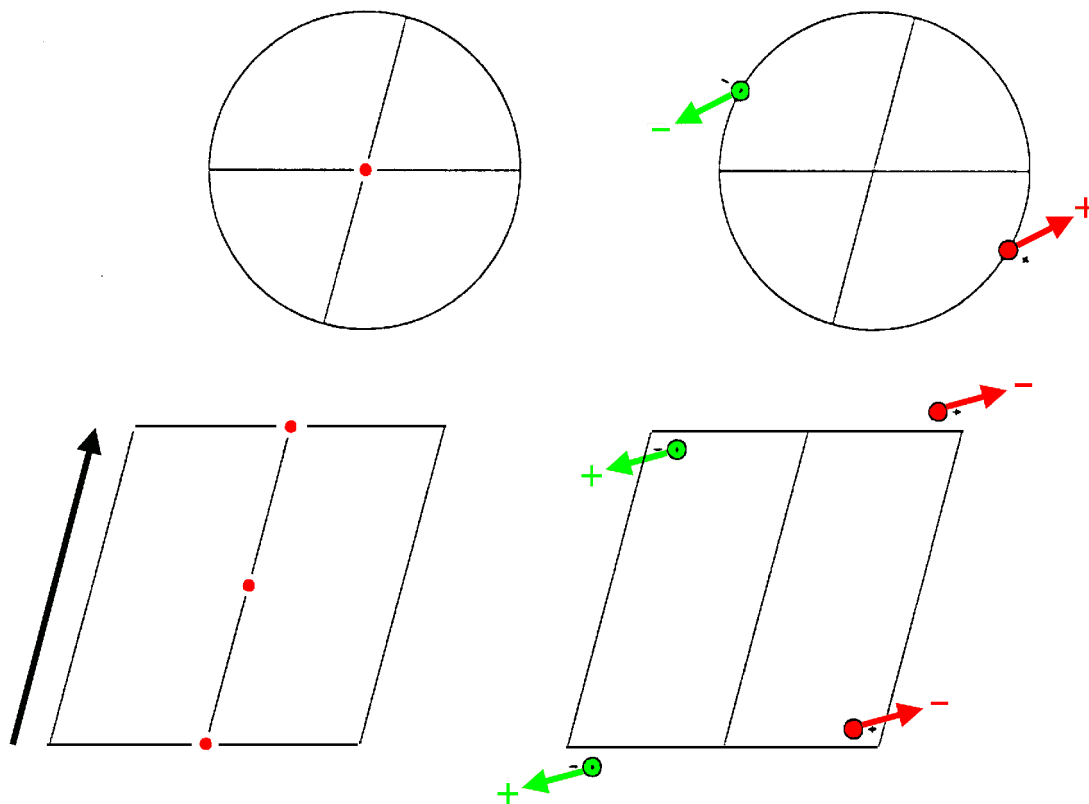

Origin at $\bar{1}$

Asymmetric unit $0 \leq z \leq 1/2$

Symmetry operations

- (1) 1
(1|0,0,0)
- (2) $\bar{1}$ 0,0,0
($\bar{1}$ |0,0,0)'

Generators selected (1); $t(0,0,1)$; (2)

Positions

		Coordinates	
Multiplicity, Wyckoff letter, Site symmetry		(1) x,y,z [u,v,w]	(2) \bar{x},\bar{y},\bar{z} [\bar{u},\bar{v},\bar{w}]
2 c 1			
1 b $\bar{1}$	0,0,1/2 [0,0,0]		
1 a $\bar{1}$	0,0,0 [0,0,0]		

Symmetry of special projections

Along [001] 211	Along [100] $\rho 211$	Along [010] $\rho 211$
Origin at 0,0,z	$a' = c_p$ Origin at x,0,0	$a' = c_p$ Origin at 0,y,0

$\rho_{2c}\bar{1}$

No. 2.4.7

$\bar{1}1'$

$\rho_{2c}\bar{1}$

Triclinic

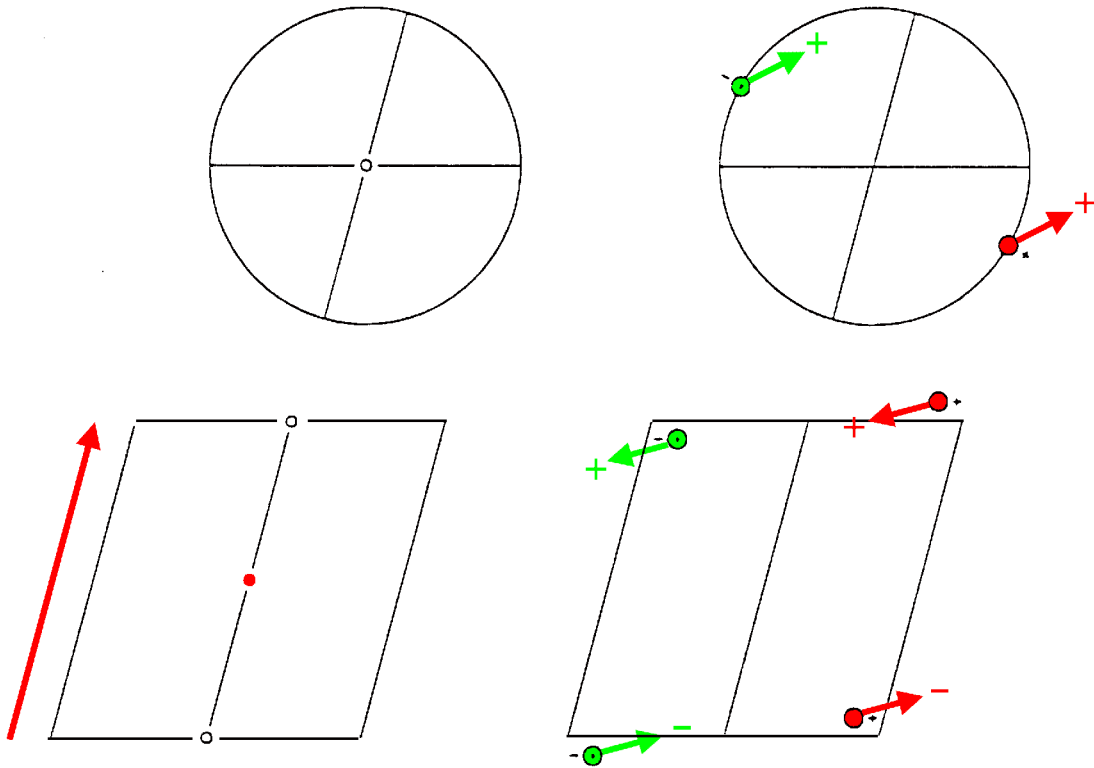

Origin at $\bar{1}$

Asymmetric unit $0 \leq z \leq 1/2$

Symmetry operations

For $(0,0,0)$ + set
 (1) 1 (2) $\bar{1}$ 0,0,0
 (1|0,0,0) ($\bar{1}$ |0,0,0)

For $(0,0,1)'$ + set
 (1) t' (0,0,1) (2) $\bar{1}'$ 0,0,1/2
 (1|0,0,1)' ($\bar{1}$ |0,0,1)'

Generators selected (1); $t(0,0,1)'$; (2)

Positions

		Coordinates	
Multiplicity, Wyckoff letter, Site symmetry		(0,0,0)+	(0,0,1)' +
2 c 1	(1) x,y,z [u,v,w]	(2) \bar{x},\bar{y},\bar{z} [u,v,w]	
1 b $\bar{1}$ '	0,0,1/2 [0,0,0]		
1 a $\bar{1}$	0,0,0 [u,v,w]		

Symmetry of special projections

Along [001] 2111'	Along [100] $P_{2a^*}2'11$	Along [010] $P_{2a^*}2'11$
Origin at 0,0,z	$a^* = c_p$ Origin at x,0,0	$a^* = c_p$ Origin at 0,y,0

$p211$

2

Monoclinic/Oblique

No. 3.1.8

$p211$

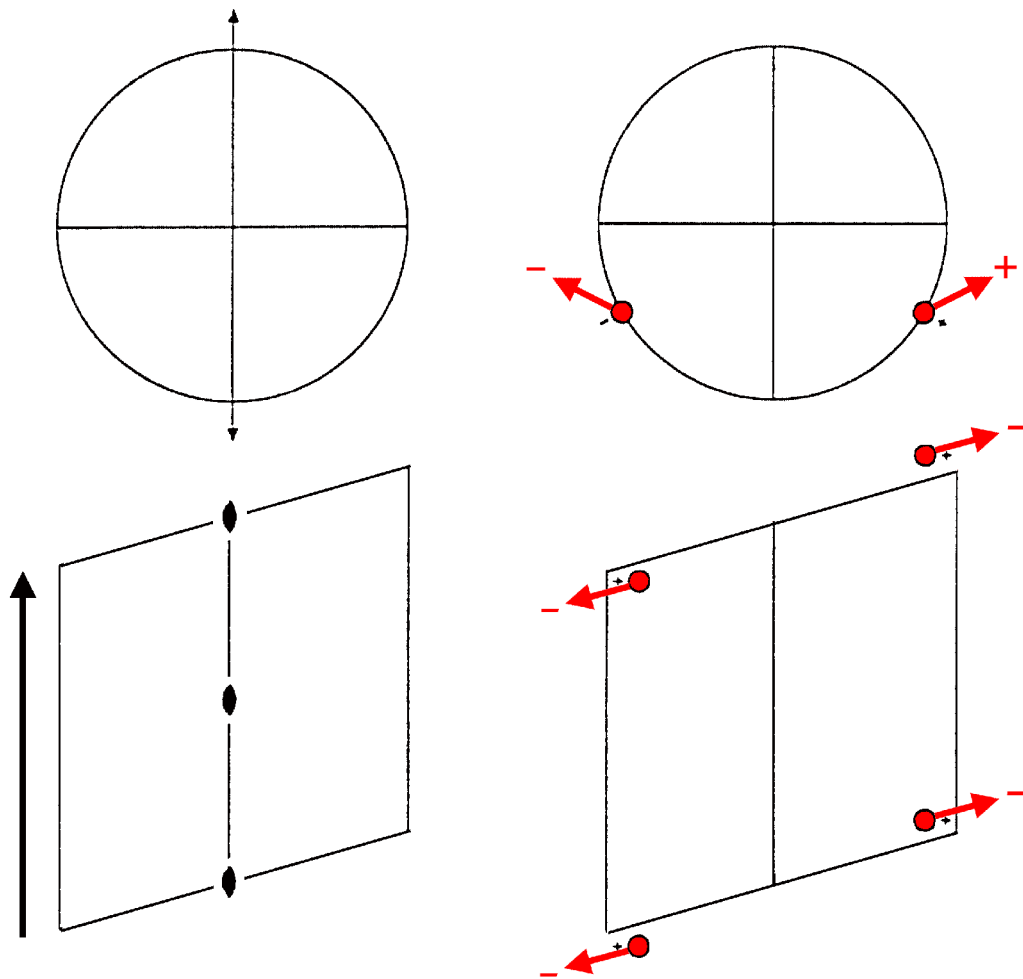

Origin on 2

Asymmetric unit $0 \leq z \leq 1/2$

Symmetry operations

(1) 1
(1|0,0,0)

(2) 2 $x,0,0$
(2_x|0,0,0)

Generators selected (1); $t(0,0,1)$; (2)

Positions

		Coordinates	
Multiplicity, Wyckoff letter, Site symmetry			
2 c 1	(1) x,y,z [u,v,w]	(2) x,\bar{y},\bar{z} [u, \bar{v} , \bar{w}]	
1 b 2	$x,0,1/2$ [u,0,0]		
1 a 2	$x,0,0$ [u,0,0]		

Symmetry of special projections

Along [001] $11m'$ Origin at 0,0,z	Along [100] $p211$ $a^* = c$ Origin at x,0,0	Along [010] $p1m'1$ $a^* = c_p$ Origin at 0,y,0
---------------------------------------	--	---

$p2111'$

$21'$

Monoclinic/Oblique

No. 3.2.9

$p2111'$

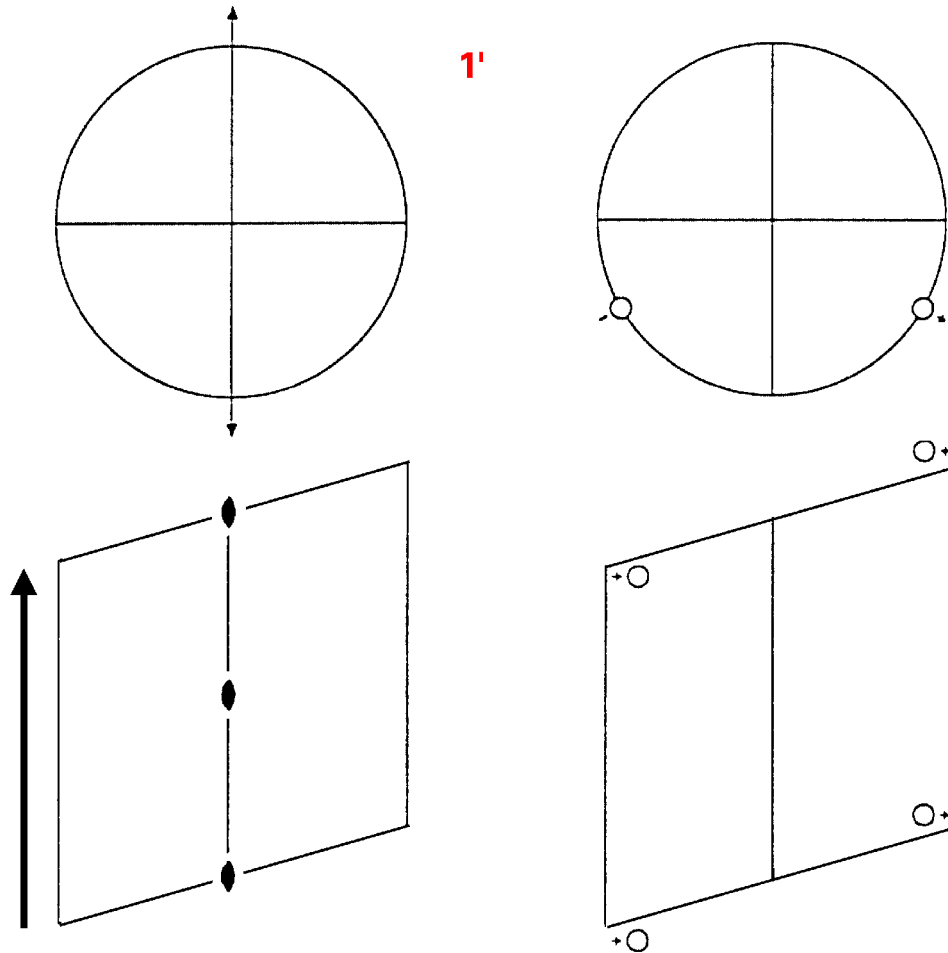

Origin on $21'$

Asymmetric unit $0 \leq z \leq 1/2$

Symmetry operations

For $1 +$ set
 (1) 1 (2) $2 \ x,0,0$
 (1) $|0,0,0$ (2) $|0,0,0$

For $1' +$ set
 (1) $1'$ (2) $2' \ x,0,0$
 (1) $|0,0,0'$ (2) $|0,0,0'$

Generators selected (1); $t(0,0,1)$; (2); $1'$

Positions

Multiplicity, Wyckoff letter, Site symmetry	Coordinates	
		1+ 1' +
2 c 11'	(1) x,y,z [0,0,0]	(2) x,\bar{y},\bar{z} [0,0,0]
1 b 21'	$x,0,1/2$ [0,0,0]	
1 a 21'	$x,0,0$ [0,0,0]	

Symmetry of special projections

Along [001] $11m1'$	Along [100] $p2111'$	Along [010] $p1m11'$
Origin at 0,0,z	$a^* = c$ Origin at $x,0,0$	$a^* = c_p$ Origin at 0,y,0

$p2'11$

No. 3.3.10

$2'$

$p2'11$

Monoclinic/Oblique

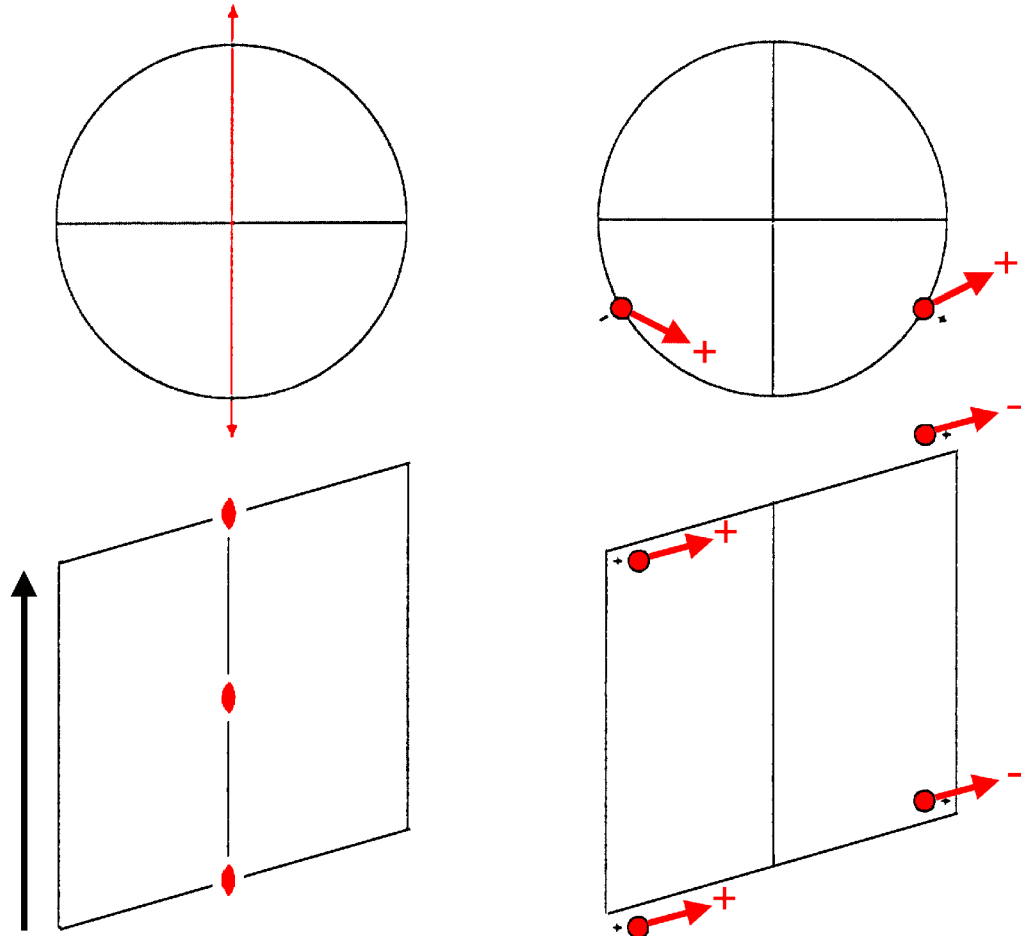

Origin on $2'$

Asymmetric unit $0 \leq z \leq 1/2$

Symmetry operations

- | | |
|--------------|--------------------|
| (1) 1 | (2) $2'_x$ $x,0,0$ |
| (1) $ 0,0,0$ | (2) $ 0,0,0$ |

Generators selected (1); $t(0,0,1)$; (2)

Positions

		Coordinates	
Multiplicity, Wyckoff letter, Site symmetry			
2 c 1	(1) x,y,z [u,v,w]	(2) x,\bar{y},\bar{z} [\bar{u} ,v,w]	
1 b 2'	$x,0,1/2$ [0,v,w]		
1 a 2'	$x,0,0$ [0,v,w]		

Symmetry of special projections

Along [001] $11m$	Along [100] $p2'11$	Along [010] $p1m1$
Origin at 0,0,z	$a^* = c$ Origin at x,0,0	$a^* = c_p$ Origin at 0,y,0

$p_{2c}211$

$21'$

Monoclinic/Oblique

No. 3.4.11

$p_{2c}211$

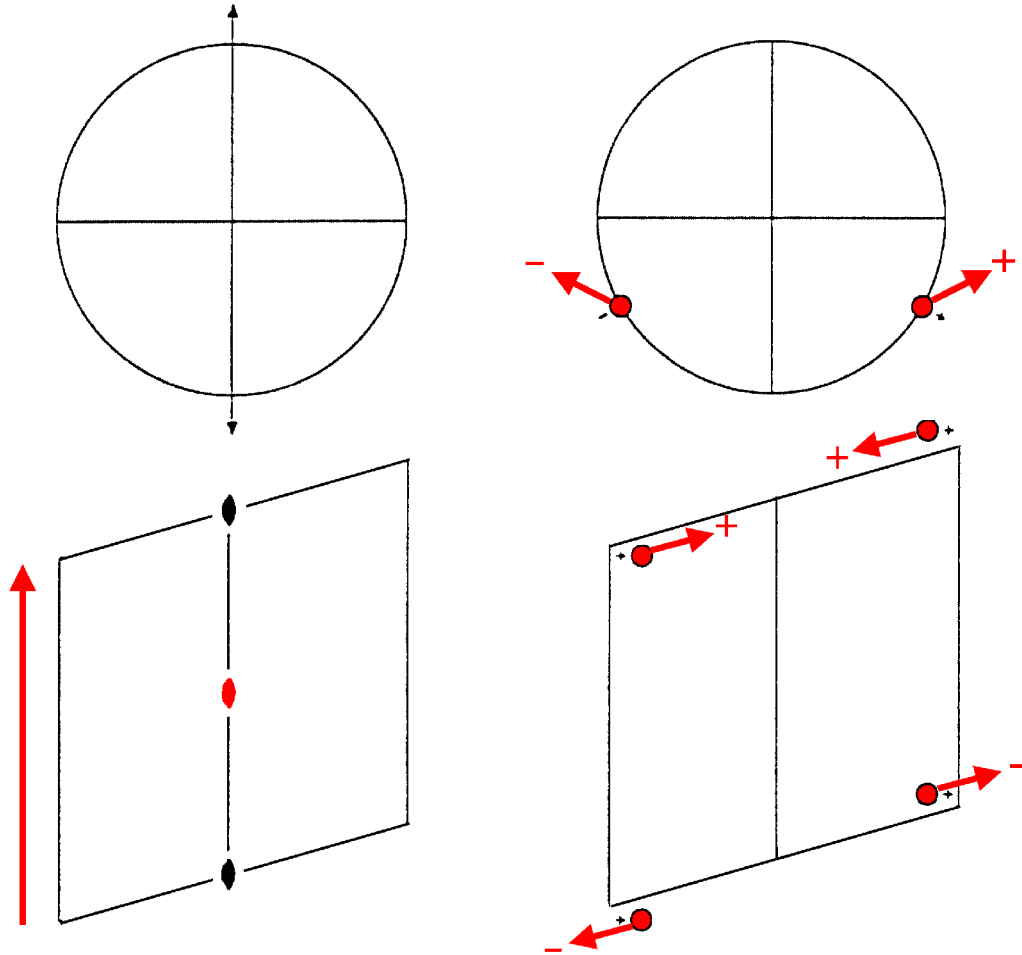

Origin on 2

Asymmetric unit $0 \leq z \leq 1/2$

Symmetry operations

For $(0,0,0)$ + set
 (1) 1 (2) $2 \ x,0,0$
 (1| $0,0,0$) (2_x| $0,0,0$)

For $(0,0,1)'$ + set
 (1) $t' \ (0,0,1)$ (2) $2' \ x,0,0; \ 0,0,1/2$
 (1| $0,0,1$)' (2_x| $0,0,1$)'

Generators selected (1); $t(0,0,1)'$; (2)

Positions

		Coordinates	
Multiplicity, Wyckoff letter, Site symmetry		(0,0,0)+	(0,0,1)' +
2 c 1	(1) x,y,z [u,v,w]	(2) x, \bar{y} , \bar{z} [u, \bar{v} , \bar{w}]	
1 b 2'	x,0,1/2 [0,v,w]		
1 a 2	x,0,0 [u,0,0]		

Symmetry of special projections

Along [001] $11m'$	Along [100] $p_{2a^*}211$	Along [010] $p_{2a^*}1m'1$
Origin at 0,0,z	$a^* = c$ Origin at x,0,0	$a^* = c_p$ Origin at 0,y,0

$pm11$

m

Monoclinic/Oblique

No. 4.1.12

$pm11$

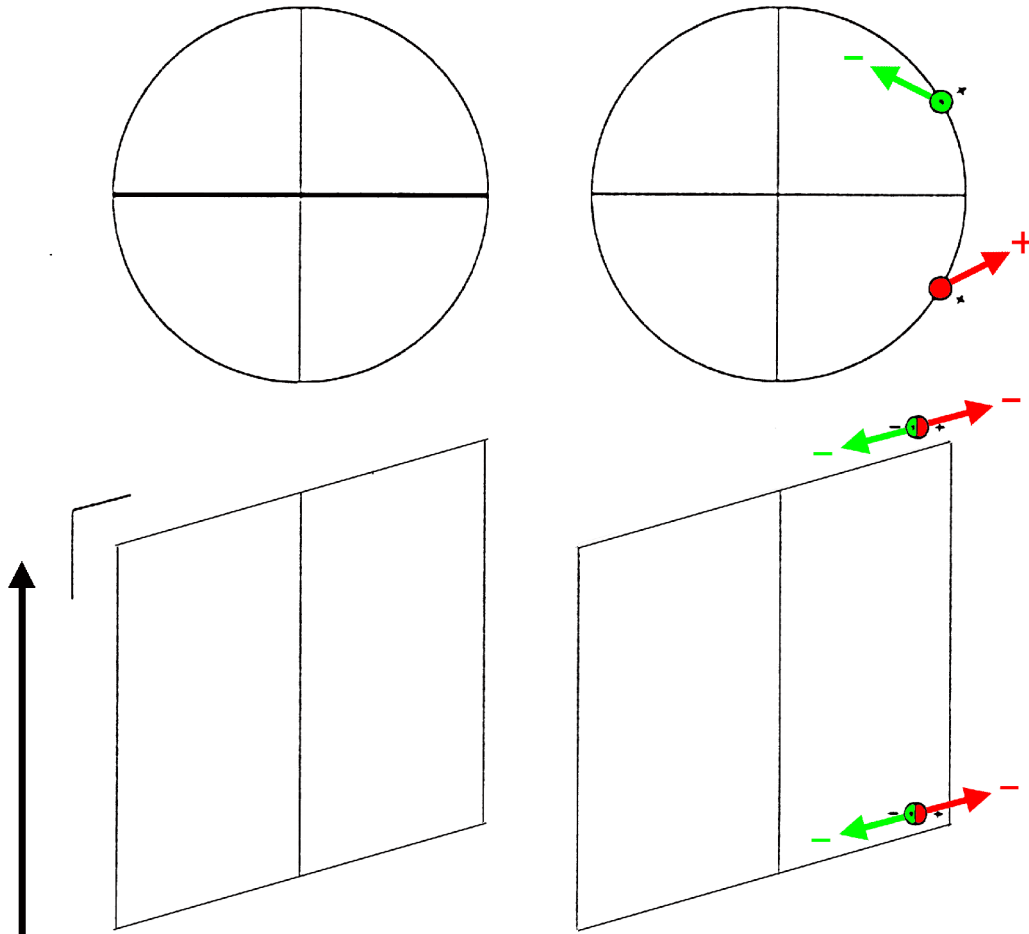

Origin on mirror plane m

Asymmetric unit $0 \leq x$; $0 \leq z \leq 1$

Symmetry operations

(1) 1 (1|0,0,0) (2) m $0,y,z$ (m_x |0,0,0)

Generators selected (1); $t(0,0,1)$; (2)

Positions

		Coordinates	
Multiplicity, Wyckoff letter, Site symmetry			
2 b 1	(1) x,y,z [u,v,w]	(2) \bar{x},y,z [u, \bar{v} , \bar{w}]	
1 a m	$0,y,z$ [u,0,0]		

Symmetry of special projections

Along [001] 1m1	Along [100] $p1111'$ $\mathbf{a}^* = \mathbf{c}$	Along [010] $p11m$ $\mathbf{a}^* = \mathbf{c}_p$
Origin at 0,0,z	Origin at x,0,0	Origin at 0,y,0

$pm111'$

$m1'$

Monoclinic/Oblique

No. 4.2.13

$pm111'$

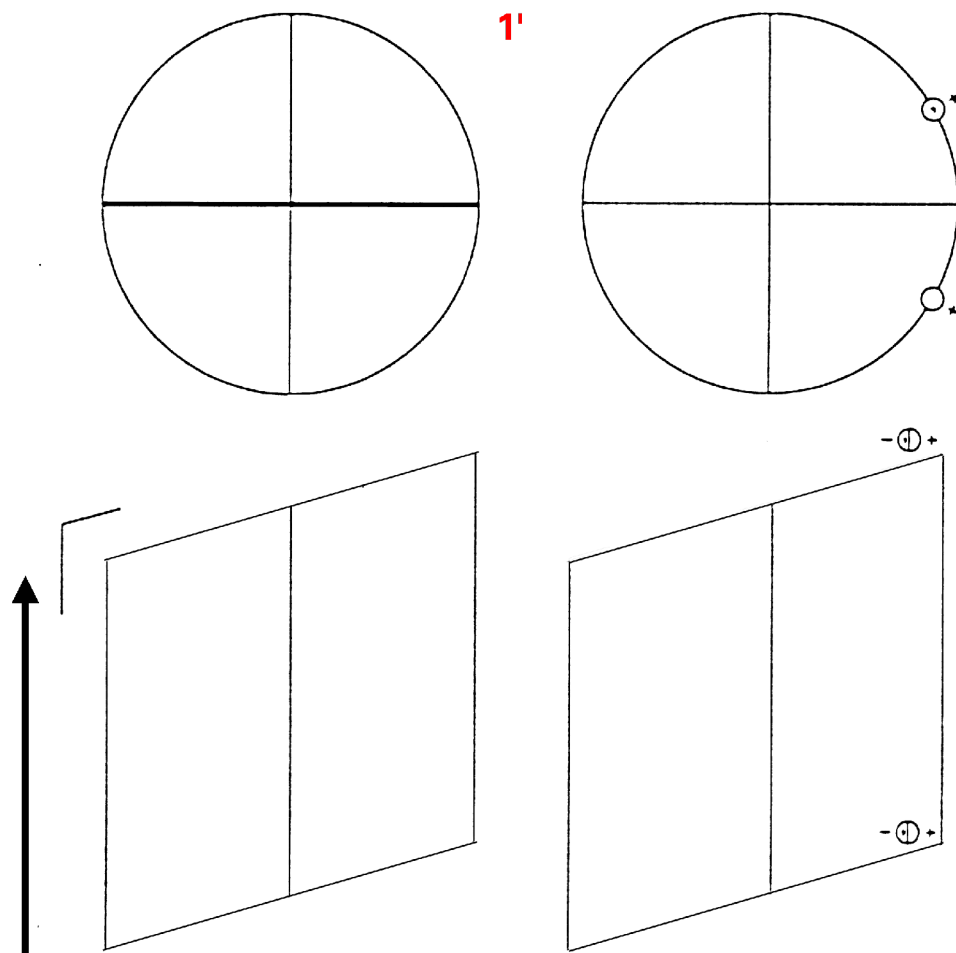

Origin on mirror plane $m1'$

Asymmetric unit $0 \leq x ; 0 \leq z \leq 1$

Symmetry operations

For 1 + set

(1) 1	(2) m	0,y,z
(1 0,0,0)	(m _x 0,0,0)	

For 1' + set

(1) 1'	(2) m'	0,y,z
(1 0,0,0)'	(m _x 0,0,0)'	

Continued

No. 4.2.13

$pm111'$

Generators selected (1); $t(0,0,1)$; (2); $1'$

Positions

		Coordinates	
Multiplicity, Wyckoff letter, Site symmetry		$1+$	$1'+$
2	$b\ 11'$	(1) $x,y,z [0,0,0]$	(2) $\bar{x},y,z [0,0,0]$
1	$a\ m1'$	$0,y,z [0,0,0]$	

Symmetry of special projections

Along $[001]$ $1m11'$	Along $[100]$ $p1111'$	Along $[010]$ $p11m1'$
Origin at $0,0,z$	$a^* = c$ Origin at $x,0,0$	$a^* = c_p$ Origin at $0,y,0$

$pm'11$

m'

Monoclinic/Oblique

No. 4.3.14

$pm'11$

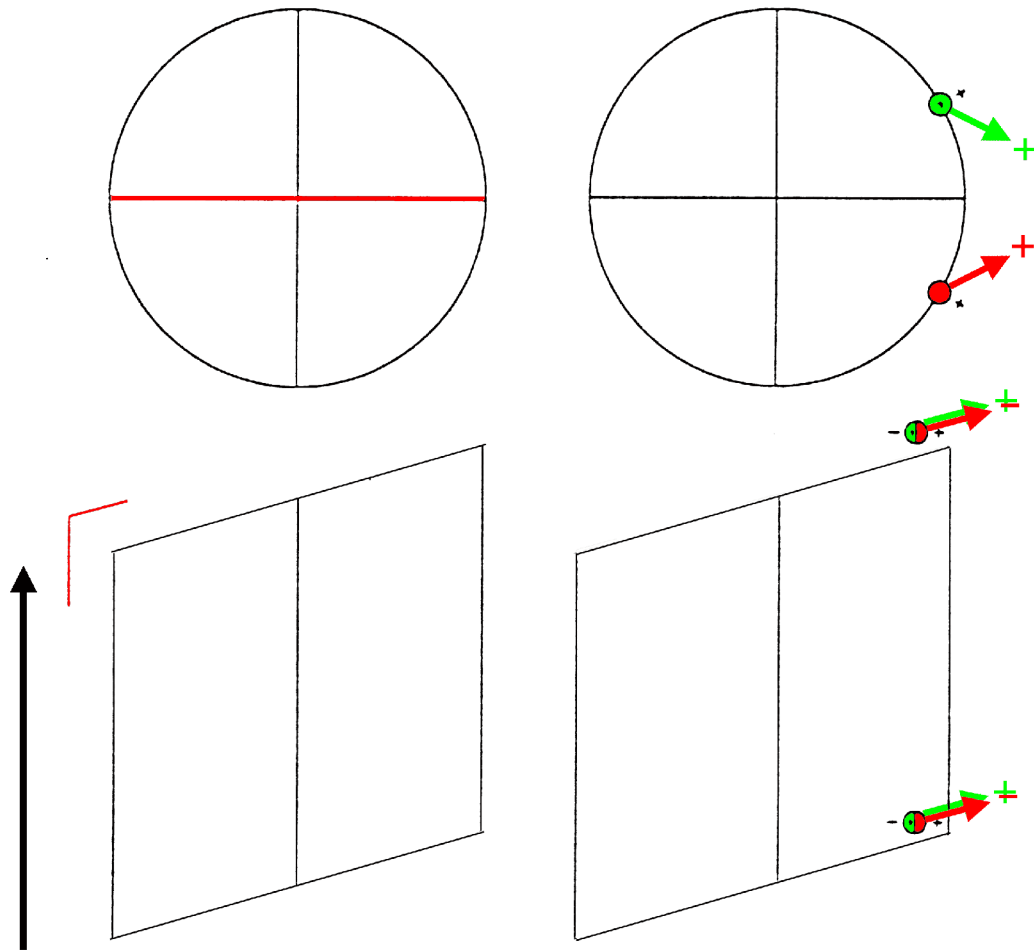

Origin on mirror plane m'

Asymmetric unit $0 \leq x$; $0 \leq z \leq 1$

Symmetry operations

- (1) 1 (2) m' $0,y,z$
 $(1|0,0,0)$ $(m_x|0,0,0)'$

Generators selected (1); $t(0,0,1)$; (2)

Positions

		Coordinates	
		Multiplicity, Wyckoff letter, Site symmetry	
2	b 1	(1) $x,y,z [u,v,w]$	(2) $\bar{x},y,z [\bar{u},v,w]$
1	a m'	$0,y,z [0,v,w]$	

Symmetry of special projections

Along [001] $1m'$	Along [100] $\rho 111$	Along [010] $\rho 11m'$
Origin at $0,0,z$	$a^* = c$ Origin at $x,0,0$	$a^* = c_p$ Origin at $0,y,0$

$\rho_{2c}.m'11$

$m1'$

Monoclinic/Oblique

No. 4.4.15

$\rho_{2c}.m'11$

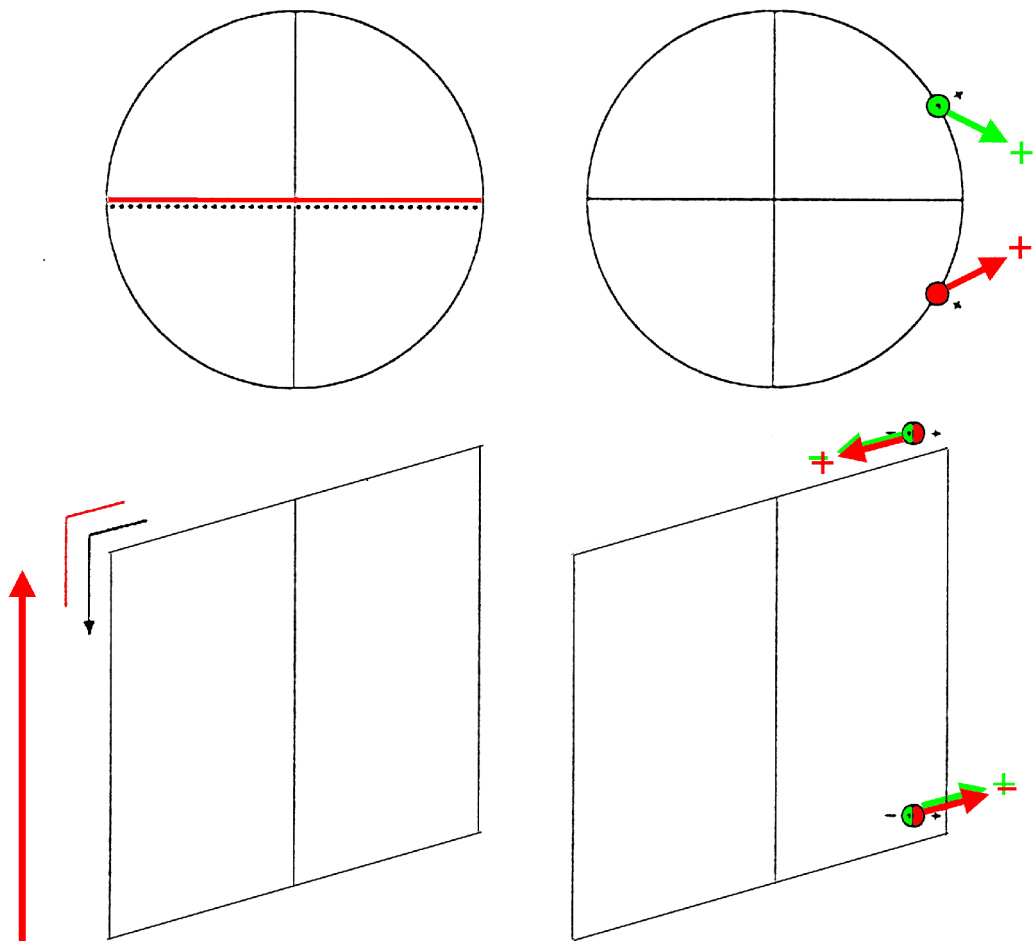

Origin on mirror plane m'

Asymmetric unit $0 \leq x ; 0 \leq z \leq 1$

Symmetry operations

For $(0,0,0) +$ set
 (1) 1 (2) $m' 0,y,z$
 (1|0,0,0) ($m_x|0,0,0$)'

For $(0,0,1)'$ + set
 (1) $t' (0,0,1)$ (2) $c (0,0,1) 0,y,z$
 (1|0,0,1)' ($m_x|0,0,1$)'

Generators selected (1); $t(0,0,1)'$; (2)

Positions

		Coordinates	
Multiplicity, Wyckoff letter, Site symmetry		(0,0,0)+	(0,0,1)' +
2	b 1	(1) $x,y,z [u,v,w]$	(2) $\bar{x},y,z [\bar{u},v,w]$
1	a m'	$0,y,z [0,v,w]$	

Symmetry of special projections

Along [001] $1m11'$	Along [100] $\rho_{2a^*}111$	Along [010] $\rho_{2a^*}11m'$
Origin at 0,0,z	$\mathbf{a}^* = \mathbf{c}$ Origin at x,0,0	$\mathbf{a}^* = \mathbf{c}_p$ Origin at 0,y,0

$\rho_{2c}m11$

$m1'$

Monoclinic/Oblique

No. 4.5.16

$\rho_{2c}m11$

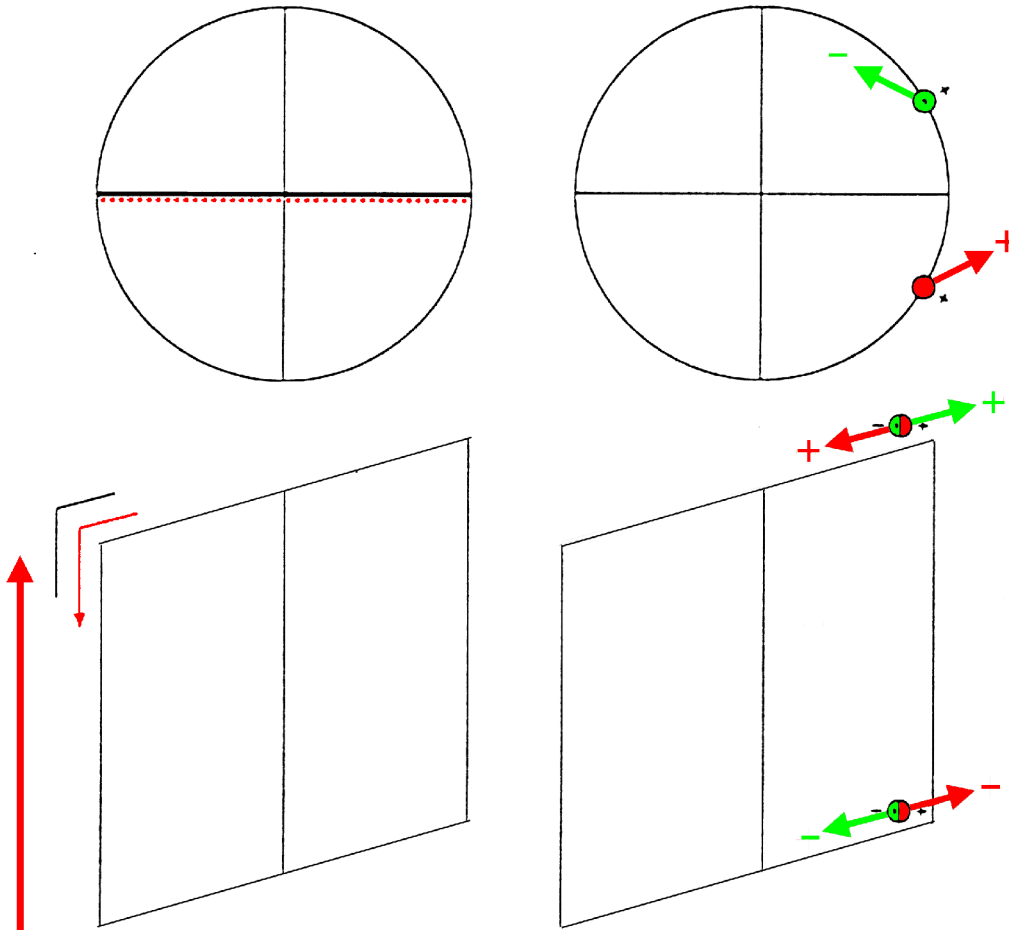

Origin on mirror plane m

Asymmetric unit $0 \leq x$; $0 \leq z \leq 1$

Symmetry operations

For $(0,0,0)$ + set
 (1) 1 (2) $m \ 0,y,z$
 (1| $0,0,0$) ($m_x|0,0,0$)

For $(0,0,1)'$ + set
 (1) $t' \ (0,0,1)$ (2) $c' \ (0,0,1) \ 0,y,z$
 (1| $0,0,1$)' ($m_x|0,0,1$)'

Generators selected (1); $t(0,0,1)'$; (2)

Positions

		Coordinates	
Multiplicity, Wyckoff letter, Site symmetry		(0,0,0)+	(0,0,1)' +
2	b 1	(1) $x,y,z [u,v,w]$	(2) $\bar{x},y,z [u,\bar{v},\bar{w}]$
1	a m	$0,y,z [u,0,0]$	

Symmetry of special projections

Along [001] $1m11'$	Along [100] $p1111'$	Along [010] $p_{2a^*}11m$
Origin at 0,0,z	$a^* = c$ Origin at x,0,0	$a^* = c_p$ Origin at 0,y,0

pc11

No. 5.1.17

m

pc11

Monoclinic/Oblique

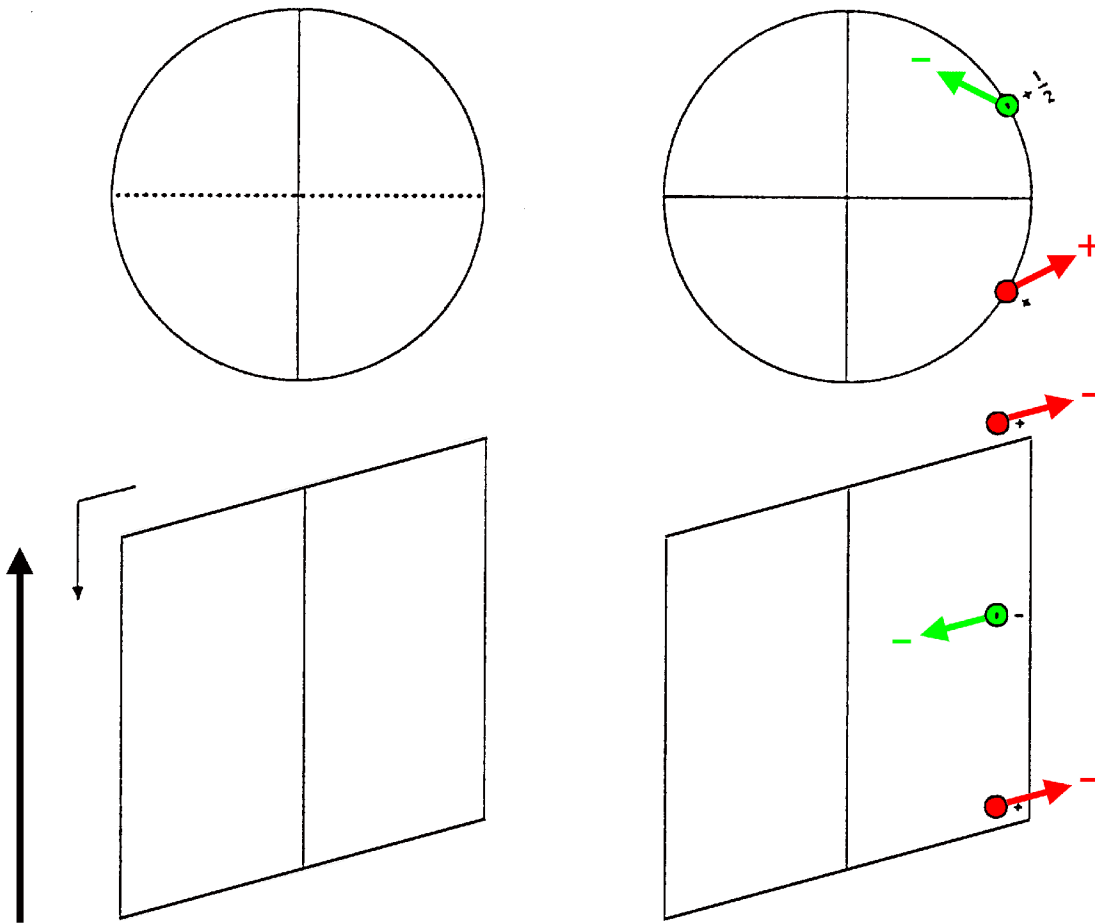

Origin on glide plane c

Asymmetric unit $0 \leq x$; $0 \leq z \leq 1$

Symmetry operations

(1) 1
(1|0,0,0)

(2) c (0,0,1/2) 0,y,z
(m_x|0,0,1/2)

Generators selected (1); $t(0,0,1)$; (2)

Positions

	Coordinates	
Multiplicity, Wyckoff letter, Site symmetry		
2 a 1	(1) x,y,z $[u,v,w]$	(2) $\bar{x},y,z+1/2$ $[u,\bar{v},\bar{w}]$

Symmetry of special projections

Along [001] $1m1$	Along [100] $p_{2a^*}1$	Along [010] $p11g$
Origin at $0,0,z$	$a^* = c/2$ Origin at $x,0,0$	$a^* = c_p$ Origin at $0,y,0$

$pc111'$

$m1'$

Monoclinic/Oblique

No. 5.2.18

$pc111'$

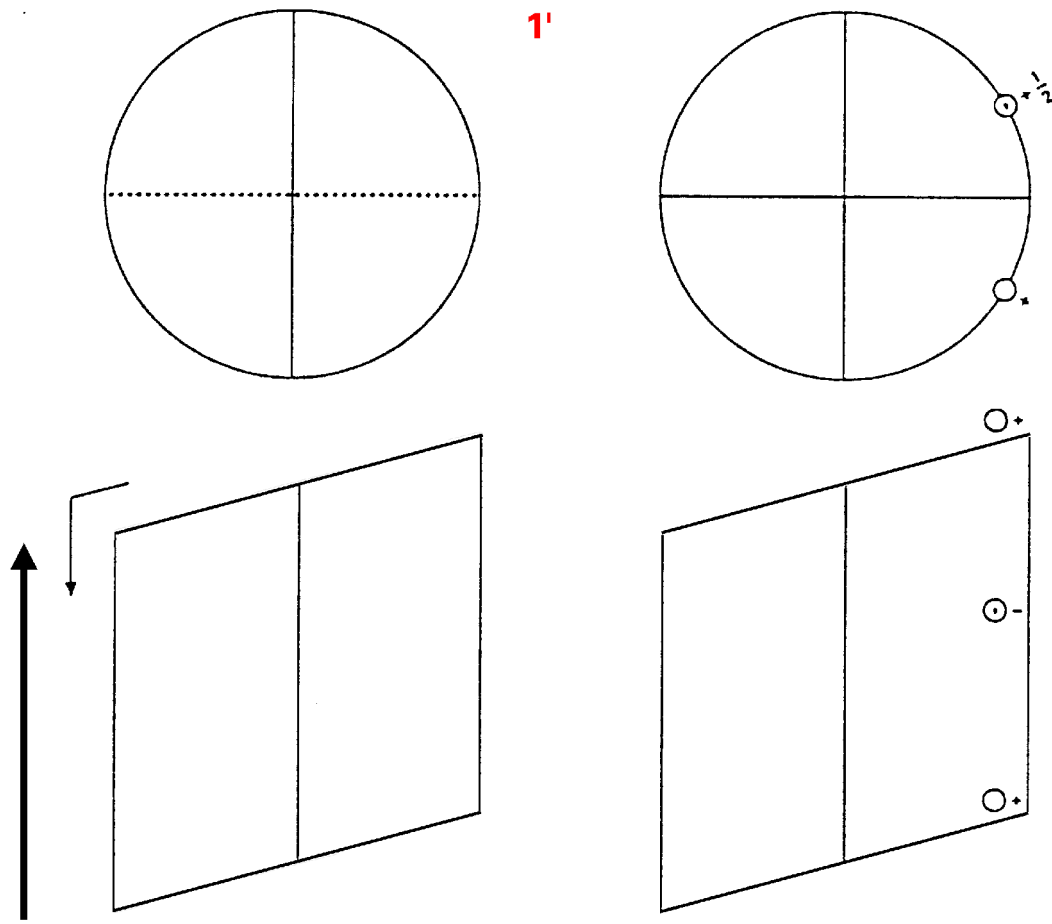

Origin on glide plane $c1'$

Asymmetric unit $0 \leq x; 0 \leq z \leq 1$

Symmetry operations

For $1 +$ set

(1) 1	(2) $c (0,0,1/2) \ 0,y,z$
$(1 0,0,0)$	$(m_x 0,0,1/2)$

For $1' +$ set

(1) $1'$	(2) $c' (0,0,1/2) \ 0,y,z$
$(1 0,0,0)'$	$(m_x 0,0,1/2)'$

Generators selected (1); $t(0,0,1)$; (2); $1'$

Positions

Multiplicity, Wyckoff letter, Site symmetry	Coordinates	
	1+	$1' +$
2 a $11'$	(1) $x,y,z [0,0,0]$	(2) $\bar{x},y,z+1/2 [0,0,0]$

Symmetry of special projections

Along $[001]$ $1m11'$	Along $[100]$ $p11'$	Along $[010]$ $p11g1'$
Origin at $0,0,z$	$a^* = c/2$ Origin at $x,0,0$	$a^* = c_p$ Origin at $0,y,0$

$pc'11$

No. 5.3.19

m'

$pc'11$

Monoclinic/Oblique

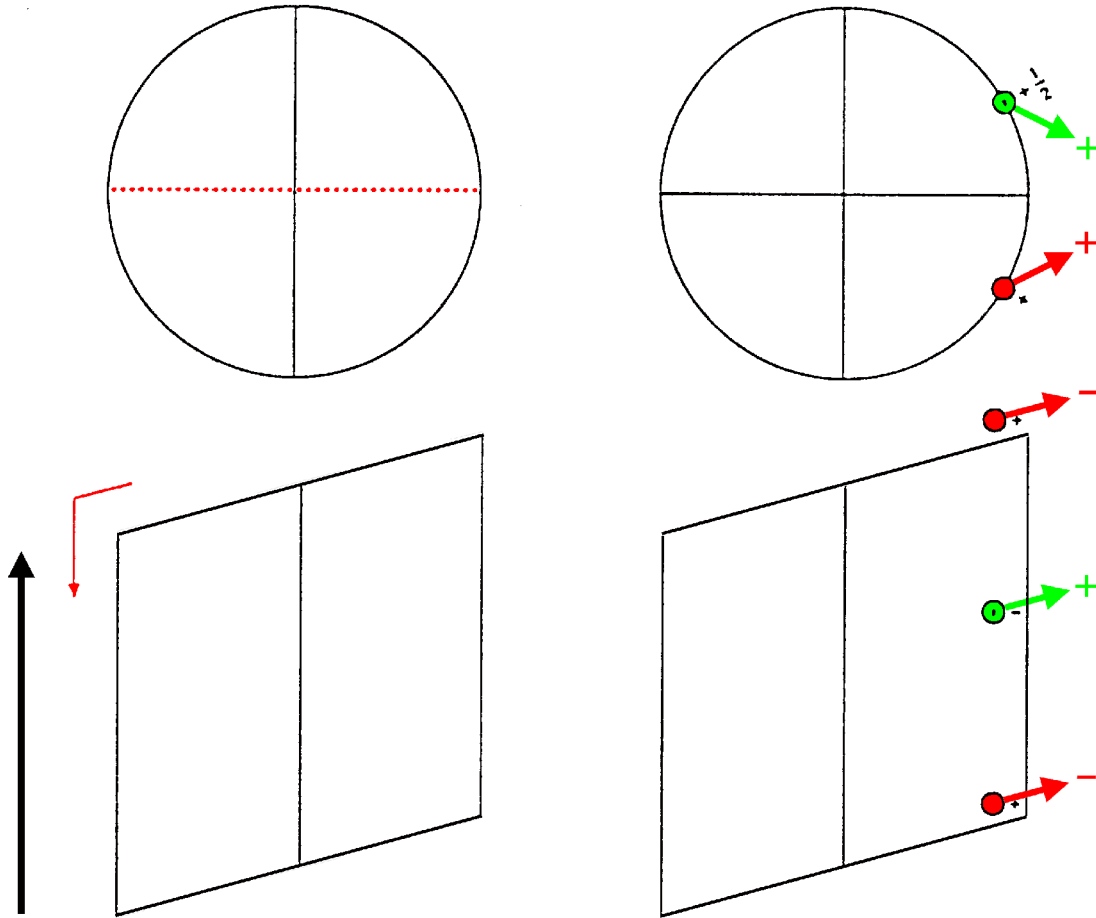

Origin on glide plane c'

Asymmetric unit $0 \leq x; 0 \leq z \leq 1$

Symmetry operations

- (1) 1 (2) $c' (0,0,1/2)$ $0,y,z$
 $(1|0,0,0)$ $(m_x|0,0,1/2)'$

Generators selected (1); $t(0,0,1)$; (2)

Positions

	Coordinates	
Multiplicity, Wyckoff letter, Site symmetry		
2 a 1	(1) $x,y,z [u,v,w]$	(2) $\bar{x},y,z+1/2 [\bar{u},v,w]$

Symmetry of special projections

Along [001] $1m'$ Origin at 0,0,z	Along [100] $p1$ $a^* = c/2$ Origin at x,0,0	Along [010] $p11g'$ $a^* = c_p$ Origin at 0,y,0
--------------------------------------	--	---

$p2/m11$

No. 6.1.20

$2/m$

$p2/m11$

Monoclinic/Oblique

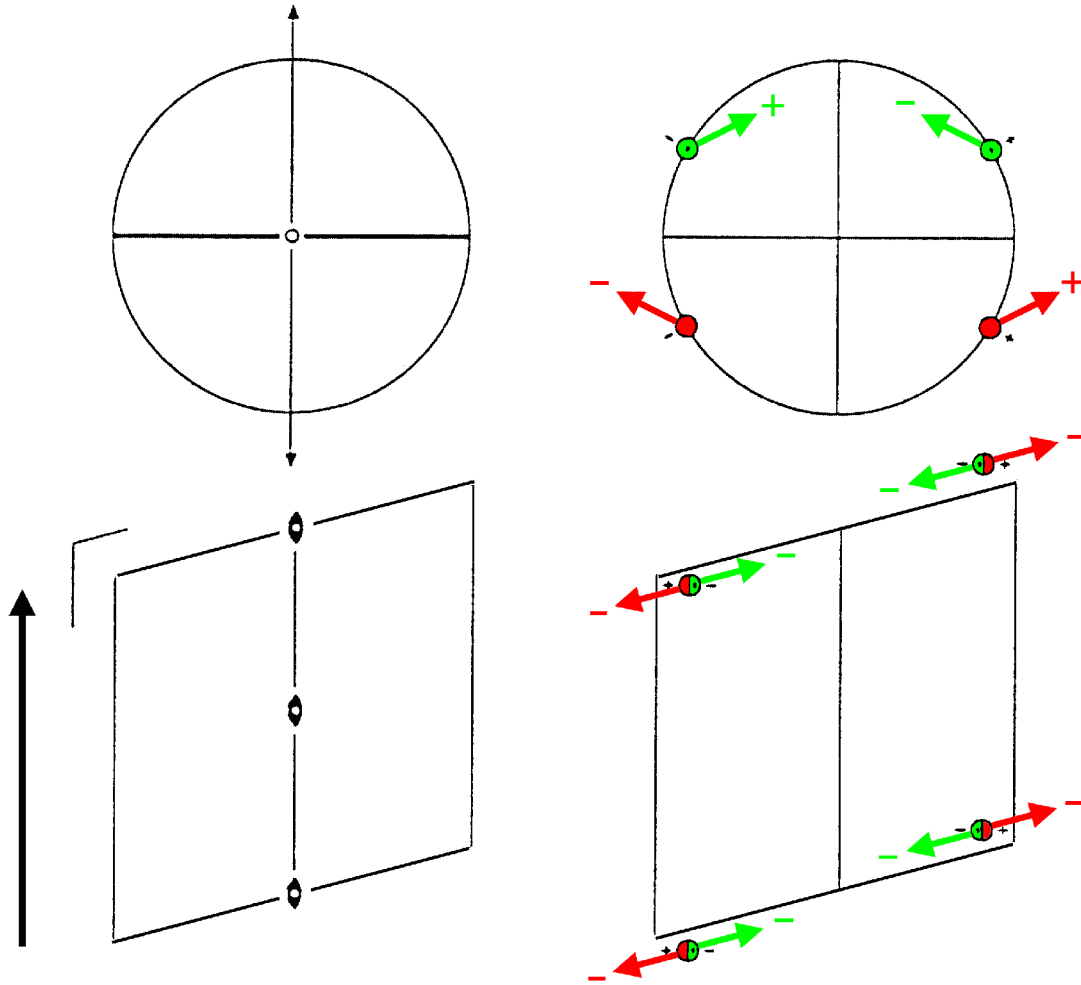

Origin at center $2/m$

Asymmetric unit $0 \leq x; 0 \leq y; 0 \leq z \leq 1$

Symmetry operations

- (1) 1
 - (2) $2 \quad x,0,0$
 - (3) $\bar{1} \quad 0,0,0$
 - (4) $m \quad 0,y,z$
- (1|0,0,0) (2_x|0,0,0) ($\bar{1}$ |0,0,0) (m_x|0,0,0)

Generators selected (1); $t(0,0,1)$; (2); (3)

Positions

Multiplicity, Wyckoff letter, Site symmetry	Coordinates	
	(1) x,y,z [u,v,w]	(2) x,\bar{y},\bar{z} [u, \bar{v} , \bar{w}]
4 f 1	(3) \bar{x},\bar{y},\bar{z} [u,v,w]	(4) \bar{x},y,z [u, \bar{v} , \bar{w}]
2 e m	0,y,z [u,0,0]	0, \bar{y} , \bar{z} [u,0,0]
2 d 2	x,0,1/2 [u,0,0]	\bar{x} ,0,1/2 [u,0,0]
2 c 2	x,0,0 [u,0,0]	\bar{x} ,0,0 [u,0,0]
1 b 2/m	0,0,1/2 [u,0,0]	
1 a 2/m	0,0,0 [u,0,0]	

Symmetry of special projections

Along [001] 2'mm'	Along [100] p2111'	Along [010] p2'm'm
Origin at 0,0,z	$\mathbf{a}^* = \mathbf{c}$ Origin at x,0,0	$\mathbf{a}^* = \mathbf{c}_p$ Origin at 0,y,0

$p2/m111'$

$2/m1'$

Monoclinic/Oblique

No. 6.2.21

$p2/m111'$

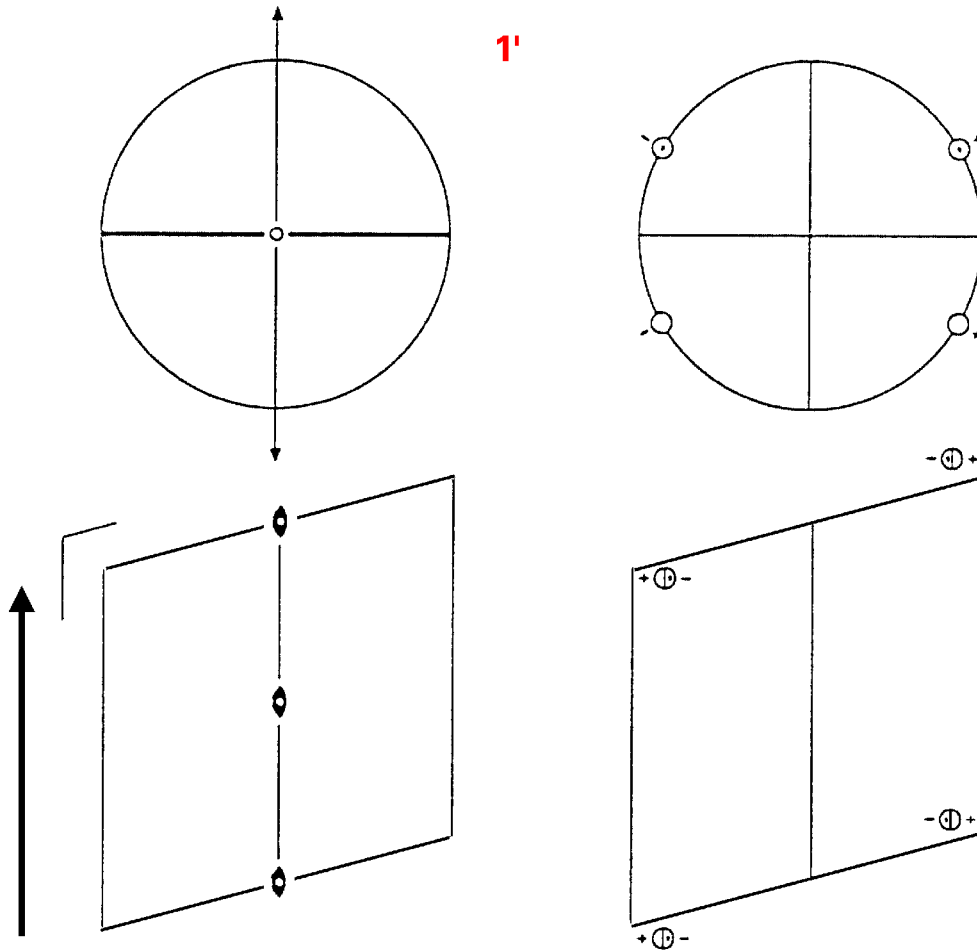

Origin at center $2/m1'$

Asymmetric unit $0 \leq x; 0 \leq y; 0 \leq z \leq 1$

Symmetry operations

For $1 +$ set

(1) 1	(2) $2 \quad x,0,0$	(3) $\bar{1} \quad 0,0,0$	(4) $m \quad 0,y,z$
$(1 0,0,0)$	$(2_x 0,0,0)$	$(\bar{1} 0,0,0)$	$(m_x 0,0,0)$

For $1' +$ set

(1) $1'$	(2) $2' \quad x,0,0$	(3) $\bar{1}' \quad 0,0,0$	(4) $m' \quad 0,y,z$
$(1 0,0,0)'$	$(2_x 0,0,0)'$	$(\bar{1} 0,0,0)'$	$(m_x 0,0,0)'$

Generators selected (1); $t(0,0,1)$; (2); (3); $1'$

Positions

Multiplicity, Wyckoff letter, Site symmetry	Coordinates	
	(1) x,y,z [0,0,0]	(2) x,\bar{y},\bar{z} [0,0,0]
4 f $11'$	(3) \bar{x},\bar{y},\bar{z} [0,0,0]	(4) \bar{x},y,z [0,0,0]
2 e $m1'$	$0,y,z$ [0,0,0]	$0,\bar{y},\bar{z}$ [0,0,0]
2 d $21'$	$x,0,1/2$ [0,0,0]	$\bar{x},0,1/2$ [0,0,0]
2 c $21'$	$x,0,0$ [0,0,0]	$\bar{x},0,0$ [0,0,0]
1 b $2/m1'$	$0,0,1/2$ [0,0,0]	
1 a $2/m1'$	$0,0,0$ [0,0,0]	

Symmetry of special projections

Along [001] $2mm1'$	Along [100] $p2111'$	Along [010] $p2mm1'$
Origin at 0,0,z	$a^* = c$ Origin at x,0,0	$a^* = c_p$ Origin at 0,y,0

$p2/m'11$

No. 6.3.22

$2/m'$

$p2/m'11$

Monoclinic/Oblique

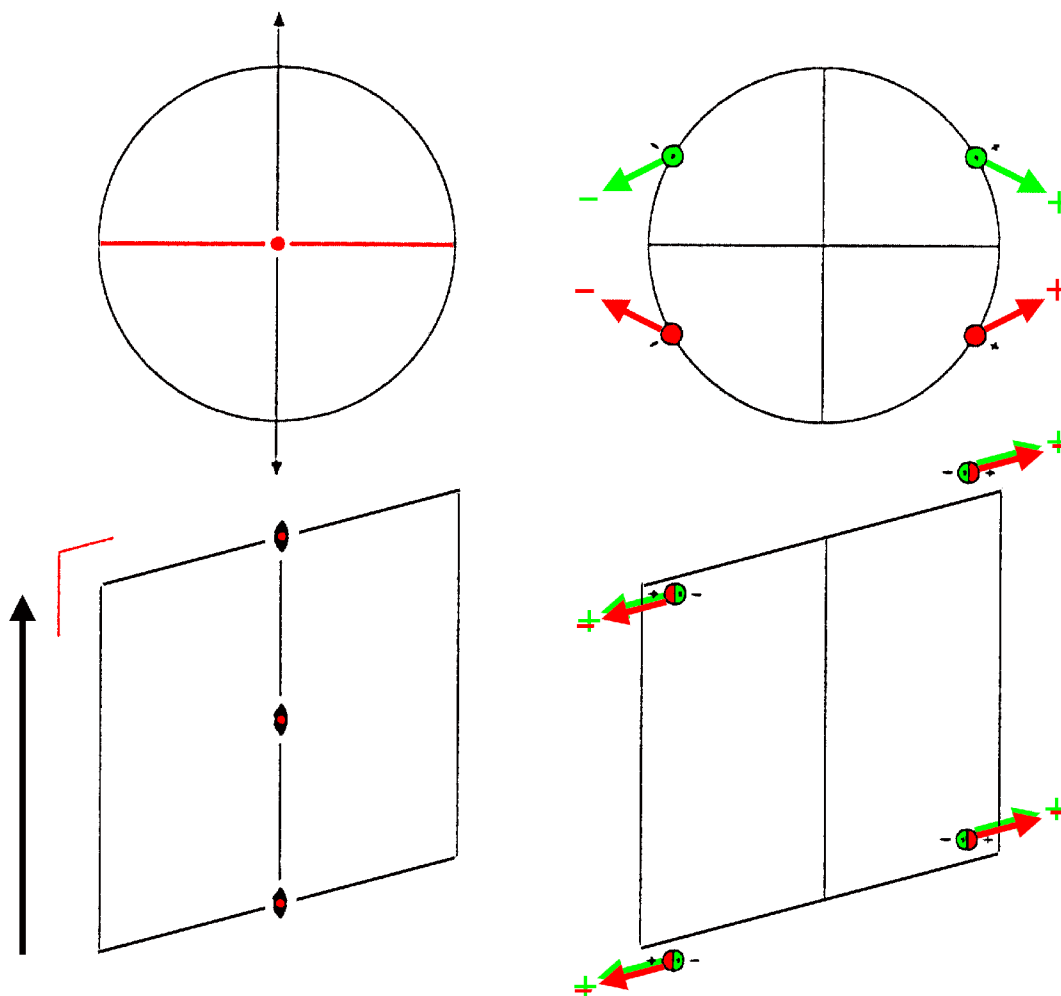

Origin at center $2/m'$

Asymmetric unit $0 \leq x; 0 \leq y; 0 \leq z \leq 1$

Symmetry operations

- (1) 1 (2) $2_x | 0,0,0$ (3) $\bar{1} | 0,0,0$ (4) $m'_y | 0,y,z$
 (1|0,0,0) (2_x|0,0,0) ($\bar{1}$ |0,0,0) (m'_x |0,0,0)'

Generators selected (1); $t(0,0,1)$; (2); (3)

Positions

Multiplicity, Wyckoff letter, Site symmetry	Coordinates	
	(1) x,y,z [u,v,w]	(2) x,\bar{y},\bar{z} [u,\bar{v},\bar{w}]
4 f 1	(1) x,y,z [u,v,w]	(2) x,\bar{y},\bar{z} [u,\bar{v},\bar{w}]
	(3) \bar{x},\bar{y},\bar{z} [\bar{u},\bar{v},\bar{w}]	(4) \bar{x},y,z [\bar{u},v,w]
2 e m'	$0,y,z$ [$0,v,w$]	$0,\bar{y},\bar{z}$ [$0,\bar{v},\bar{w}$]
2 d 2	$x,0,1/2$ [$u,0,0$]	$\bar{x},0,1/2$ [$\bar{u},0,0$]
2 c 2	$x,0,0$ [$u,0,0$]	$\bar{x},0,0$ [$\bar{u},0,0$]
1 b $2/m'$	$0,0,1/2$ [$0,0,0$]	
1 a $2/m'$	$0,0,0$ [$0,0,0$]	

Symmetry of special projections

Along [001] $2m'm'$	Along [100] $p211$	Along [010] $p2m'm'$
Origin at $0,0,z$	$a^* = c$ Origin at $x,0,0$	$a^* = c_p$ Origin at $0,y,0$

$p2'/m'11$

No. 6.4.23

$2'/m'$

$p2'/m'11$

Monoclinic/Oblique

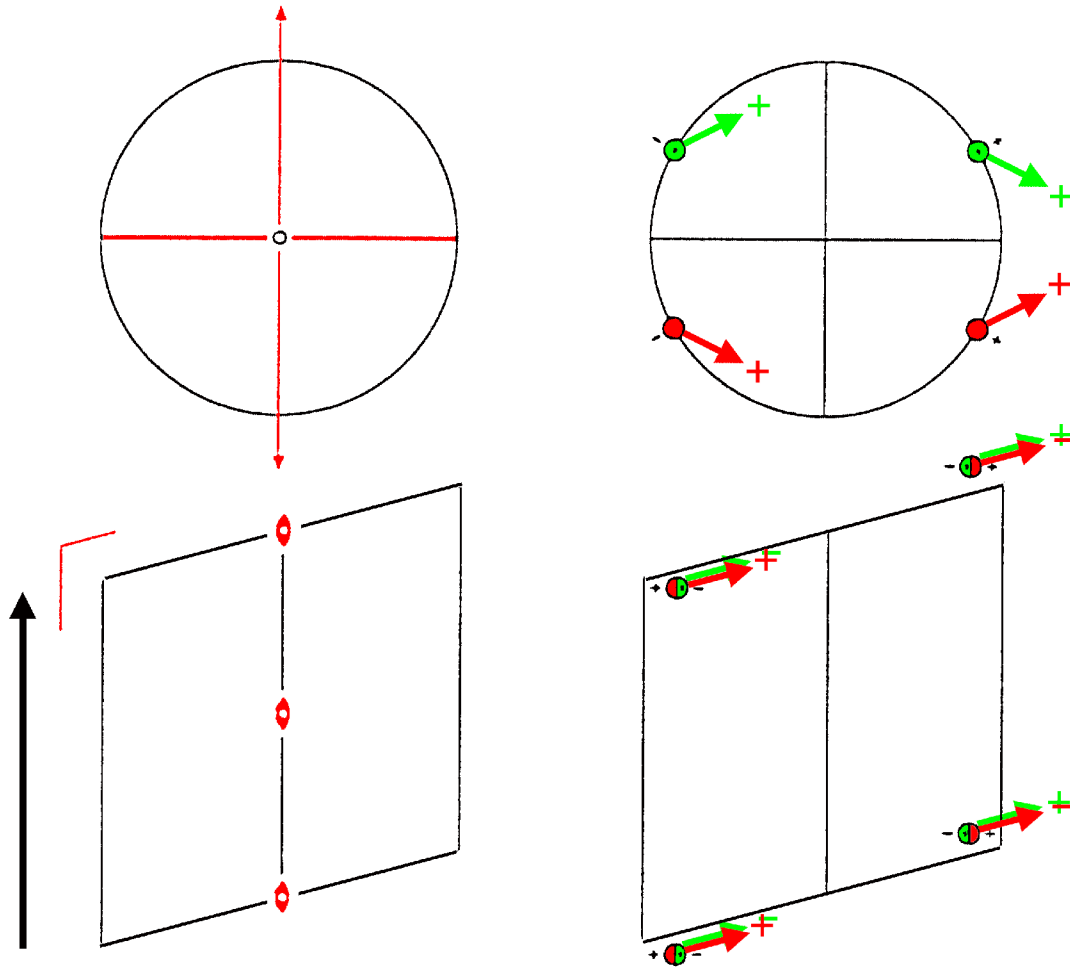

Origin at center $2'/m'$

Asymmetric unit $0 \leq x; 0 \leq y; 0 \leq z \leq 1$

Symmetry operations

- | | | | |
|---------------|-----------------------|-------------------------|-----------------------|
| (1) 1 | (2) $2'_x$ $x,0,0$ | (3) $\bar{1}$ $0,0,0$ | (4) m'_y $0,y,z$ |
| (1 $0,0,0$) | ($2'_x$ $0,0,0$)' | ($\bar{1}$ $0,0,0$) | (m'_y $0,0,0$)' |

Generators selected (1); $t(0,0,1)$; (2); (3)

Positions

Multiplicity, Wyckoff letter, Site symmetry	Coordinates	
	(1) x,y,z [u,v,w]	(2) x,\bar{y},\bar{z} [\bar{u} ,v,w]
4 f 1	(3) \bar{x},\bar{y},\bar{z} [u,v,w]	(4) \bar{x},y,z [\bar{u} ,v,w]
2 e m'	$0,y,z$ [0,v,w]	$0,\bar{y},\bar{z}$ [0,v,w]
2 d $2'$	$x,0,1/2$ [0,v,w]	$\bar{x},0,1/2$ [0,v,w]
2 c $2'$	$x,0,0$ [0,v,w]	$\bar{x},0,0$ [0,v,w]
1 b $2'/m'$	$0,0,1/2$ [0,v,w]	
1 a $2'/m'$	$0,0,0$ [0,v,w]	

Symmetry of special projections

Along [001] $2'm'm$	Along [100] $p2'11$	Along [010] $p2'mm'$
Origin at 0,0,z	$a^* = c$ Origin at x,0,0	$a^* = c_p$ Origin at 0,y,0

$p2'/m11$

No. 6.5.24

$2'/m$

$p2'/m11$

Monoclinic/Oblique

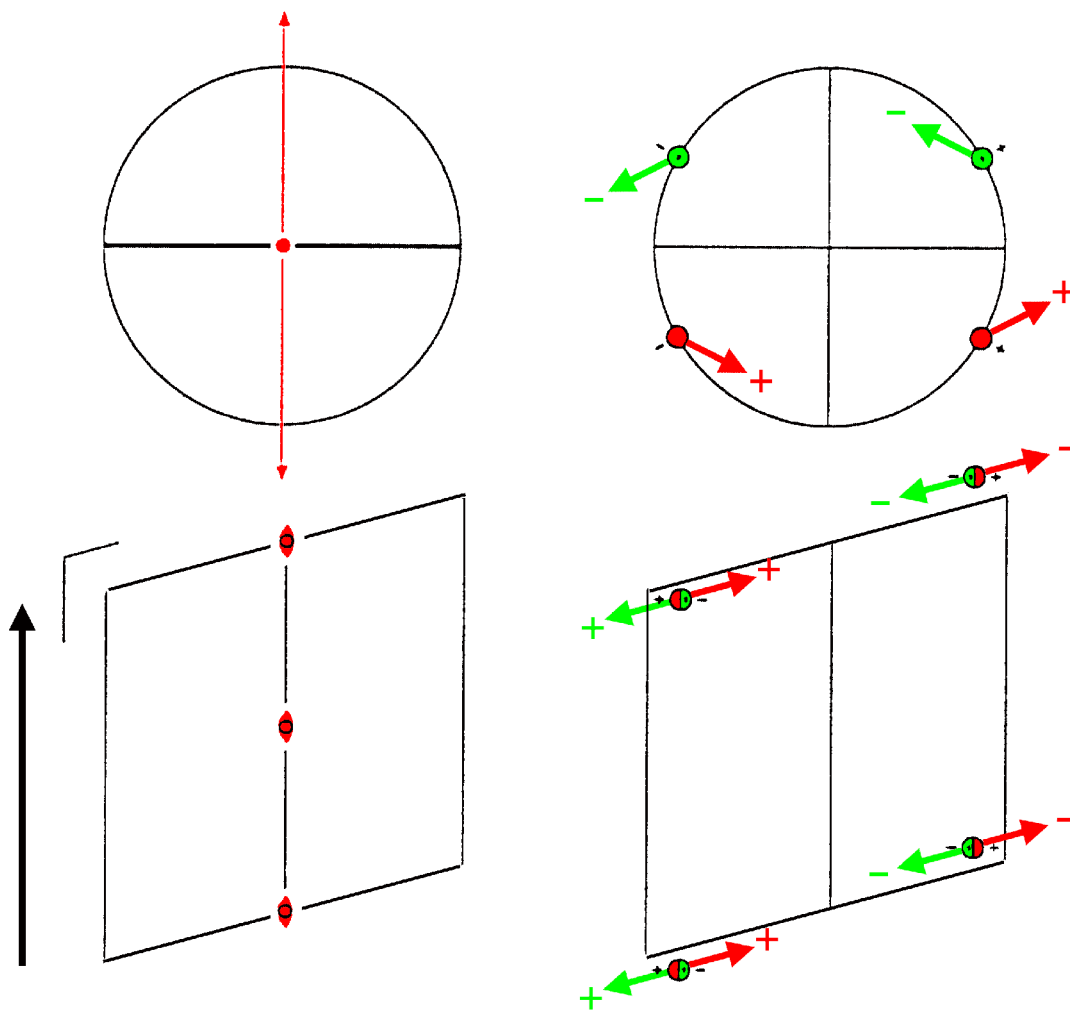

Origin at center $2'/m$

Asymmetric unit $0 \leq x; 0 \leq y; 0 \leq z \leq 1$

Symmetry operations

- | | | | |
|-----------|--------------------|------------------------|-----------------|
| (1) 1 | (2) $2'_x$ $x,0,0$ | (3) $\bar{1}'$ $0,0,0$ | (4) m $0,y,z$ |
| (1 0,0,0) | ($2'_x$ 0,0,0)' | ($\bar{1}$ 0,0,0)' | (m_x 0,0,0) |

Generators selected (1); $t(0,0,1)$; (2); (3)

Positions

Multiplicity, Wyckoff letter, Site symmetry	Coordinates	
	(1) x,y,z [u,v,w]	(2) x,\bar{y},\bar{z} [\bar{u},v,w]
4 f 1	(1) x,y,z [u,v,w]	(2) x,\bar{y},\bar{z} [\bar{u},v,w]
	(3) \bar{x},\bar{y},\bar{z} [\bar{u},\bar{v},\bar{w}]	(4) \bar{x},y,z [u,\bar{v},\bar{w}]
2 e m	$0,y,z$ [u,0,0]	$0,\bar{y},\bar{z}$ [$\bar{u},0,0$]
2 d 2'	$x,0,1/2$ [0,v,w]	$\bar{x},0,1/2$ [0, \bar{v},\bar{w}]
2 c 2'	$x,0,0$ [0,v,w]	$\bar{x},0,0$ [0, \bar{v},\bar{w}]
1 b 2'/m	$0,0,1/2$ [0,0,0]	
1 a 2'/m	$0,0,0$ [0,0,0]	

Symmetry of special projections

Along [001] $2mm$	Along [100] $p2111'$	Along [010] $p2mm$
Origin at 0,0,z	$a^* = c$ Origin at x,0,0	$a^* = c_p$ Origin at 0,y,0

$p_{2c}2'/m'11$

$2/m1'$

Monoclinic/Oblique

No. 6.6.25

$p_{2c}2'/m'11$

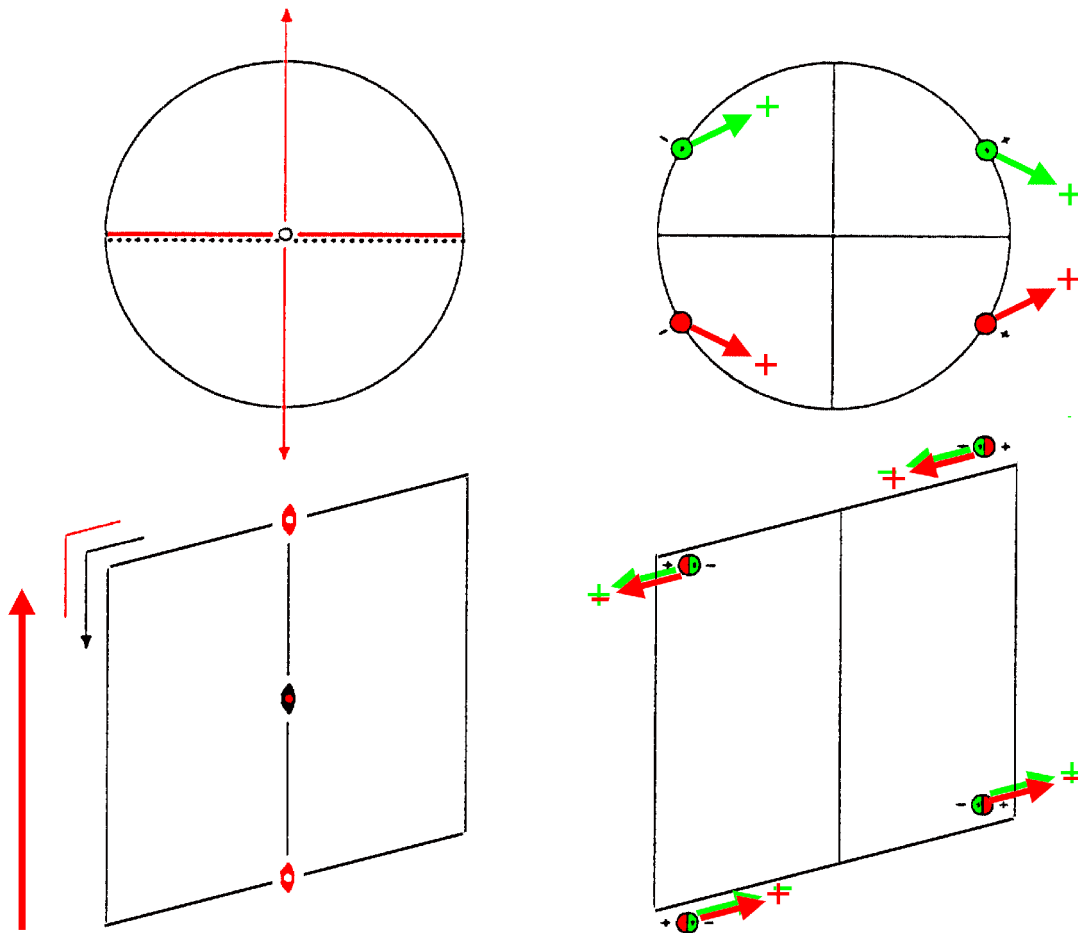

Origin at center $2'/m'$

Asymmetric unit $0 \leq x; 0 \leq y; 0 \leq z \leq 1$

Symmetry operations

For $(0,0,0)$ + set

(1) 1	(2) $2' \ x,0,0$	(3) $\bar{1} \ 0,0,0$	(4) $m' \ 0,y,z$
(1 0,0,0)	(2 _x 0,0,0)'	($\bar{1}$ 0,0,0)	(m_x 0,0,0)'

For $(0,0,1)'$ + set

(1) $t' \ (0,0,1)$	(2) $2 \ x,0,1/2$	(3) $\bar{1} \ 0,0,1/2$	(4) $c \ (0,0,1) \ 0,y,z$
(1 0,0,1)'	(2 _x 0,0,1)	($\bar{1}$ 0,0,1)'	(m_x 0,0,1)

Generators selected (1); $t(0,0,1)'$; (2); (3)

Positions

Multiplicity, Wyckoff letter, Site symmetry	Coordinates	
		(0,0,0)+ (0,0,1)' +
4 f 1	(1) $x,y,z [u,v,w]$	(2) $x,\bar{y},\bar{z} [u,\bar{v},\bar{w}]$
	(3) $\bar{x},\bar{y},\bar{z} [u,v,w]$	(4) $\bar{x},y,z [u,\bar{v},\bar{w}]$
2 e m'	$0,y,z [0,v,w]$	$0,\bar{y},\bar{z} [0,v,w]$
2 d 2	$x,0,1/2 [u,0,0]$	$\bar{x},0,1/2 [\bar{u},0,0]$
2 c 2'	$x,0,0 [0,v,w]$	$\bar{x},0,0 [0,v,w]$
1 b $2/m'$	$0,0,1/2 [0,0,0]$	
1 a $2'/m'$	$0,0,0 [0,v,w]$	

Symmetry of special projections

Along [001] $2mm1'$	Along [100] $\rho_{2a^*}211$	Along [010] $\rho_{2a^*}2mm$
Origin at 0,0,z	$a^* = c$ Origin at x,0,0	$a^* = c_p$ Origin at 0,y,0

$p_{2c}2/m11$

No. 6.7.26

$2/m1'$

$p_{2c}2/m11$

Monoclinic/Oblique

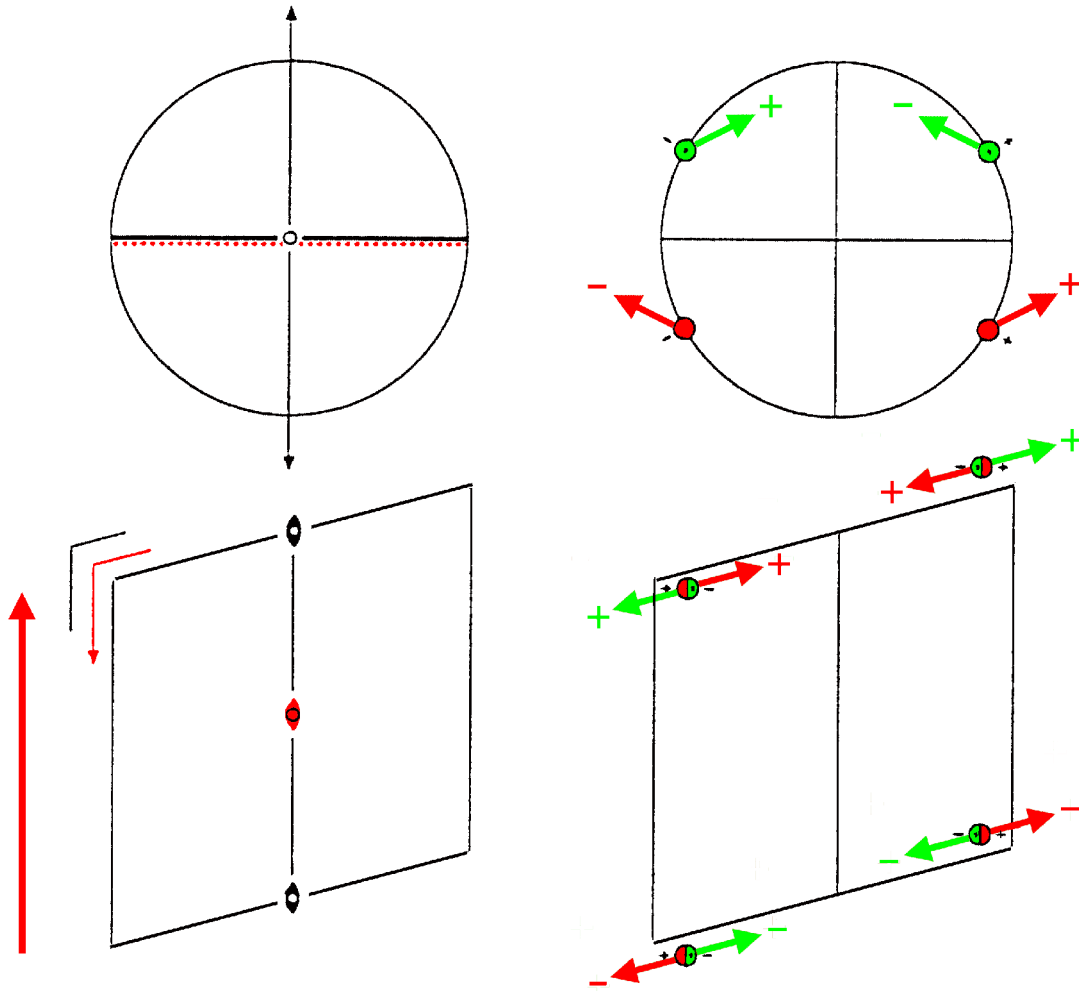

Origin at center $2/m$

Asymmetric unit $0 \leq x; 0 \leq y; 0 \leq z \leq 1$

Symmetry operations

For $(0,0,0) +$ set

(1) 1	(2) 2_x $x,0,0$	(3) $\bar{1}$ $0,0,0$	(4) m $0,y,z$
$(1 0,0,0)$	$(2_x 0,0,0)$	$(\bar{1} 0,0,0)$	$(m_x 0,0,0)$

For $(0,0,1)'$ + set

(1) t' $(0,0,1)$	(2) $2'_x$ $x,0,1/2$	(3) $\bar{1}'$ $0,0,1/2$	(4) c' $(0,0,1)$ $0,y,z$
$(1 0,0,1)'$	$(2'_x 0,0,1)'$	$(\bar{1}' 0,0,1)'$	$(m_x 0,0,1)'$

Generators selected (1); $t(0,0,1)'$; (2); (3)

Positions

Multiplicity, Wyckoff letter, Site symmetry	Coordinates	
		$(0,0,0)+$ $(0,0,1)'+$
4 f 1	(1) x,y,z [u,v,w]	(2) x,\bar{y},\bar{z} [u, \bar{v} , \bar{w}]
	(3) \bar{x},\bar{y},\bar{z} [u,v,w]	(4) \bar{x},y,z [u, \bar{v} , \bar{w}]
2 e m	$0,y,z$ [u,0,0]	$0,\bar{y},\bar{z}$ [u,0,0]
2 d 2'	$x,0,1/2$ [0,v,w]	$\bar{x},0,1/2$ [0, \bar{v} , \bar{w}]
2 c 2	$x,0,0$ [u,0,0]	$\bar{x},0,0$ [u,0,0]
1 b 2'/m	$0,0,1/2$ [0,0,0]	
1 a 2/m	$0,0,0$ [u,0,0]	

Symmetry of special projections

Along [001] $2mm'$	Along [100] $p2111'$	Along [010] $p_{2a}2'm'm$
Origin at 0,0,z	$a^* = c$ Origin at x,0,0	$a^* = c_p$ Origin at 0,y,0

$p2/c11$

$2/m$

Monoclinic/Oblique

No. 7.1.27

$p2/c11$

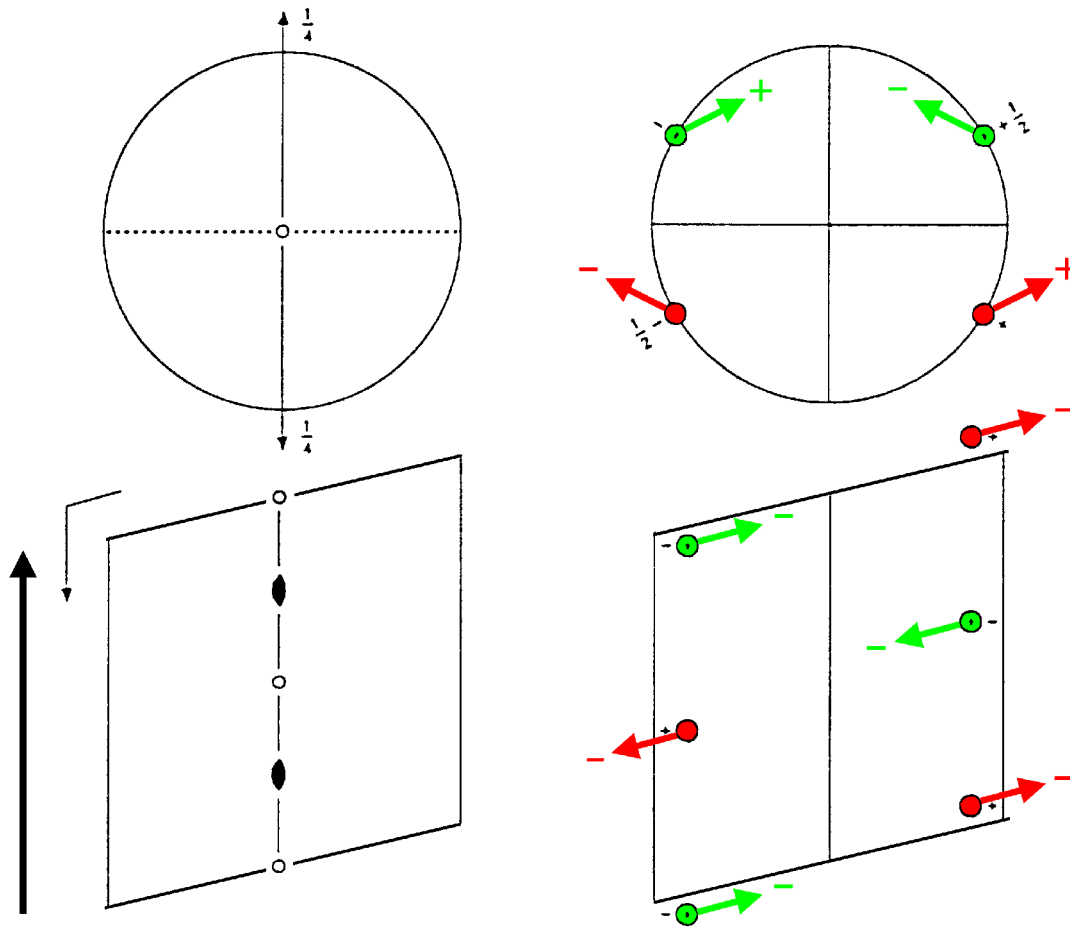

Origin at $\bar{1}$ on glide plane c

Asymmetric unit $0 \leq x; 0 \leq y; 0 \leq z \leq 1$

Symmetry operations

- | | | | |
|-------------|-------------------------|-------------------|-------------------------|
| (1) 1 | (2) 2_x | (3) $\bar{1}$ | (4) c |
| $(1 0,0,0)$ | $(2_x 0,0,\frac{1}{2})$ | $(\bar{1} 0,0,0)$ | $(c 0,0,\frac{1}{2})$ |
| | | | $(m_x 0,0,\frac{1}{2})$ |

Generators selected (1); $t(0,0,1)$; (2); (3)

Positions

		Coordinates	
Multiplicity, Wyckoff letter, Site symmetry			
4 c 1	(1)	x,y,z [u,v,w]	(2) $x,\bar{y},\bar{z}+1/2$ [u, \bar{v} , \bar{w}]
	(3)	\bar{x},\bar{y},\bar{z} [u,v,w]	(4) $\bar{x},y,z+1/2$ [u, \bar{v} , \bar{w}]
	2 b 2	$x,0,1/4$ [u,0,0]	$\bar{x},0,3/4$ [u,0,0]
	2 a $\bar{1}$	$0,0,0$ [u,v,w]	$0,0,1/2$ [u, \bar{v} , \bar{w}]

Symmetry of special projections

Along [001] $2'mm'$	Along [100] $p_{2a^*}211$	Along [010] $p2'm'g$
Origin at 0,0,z	$a^* = c/2$ Origin at $x,0,1/4$	$a^* = c_p$ Origin at 0,y,0

$p2/c111'$

No. 7.2.28

$2/m1'$

$p2/c111'$

Monoclinic/Oblique

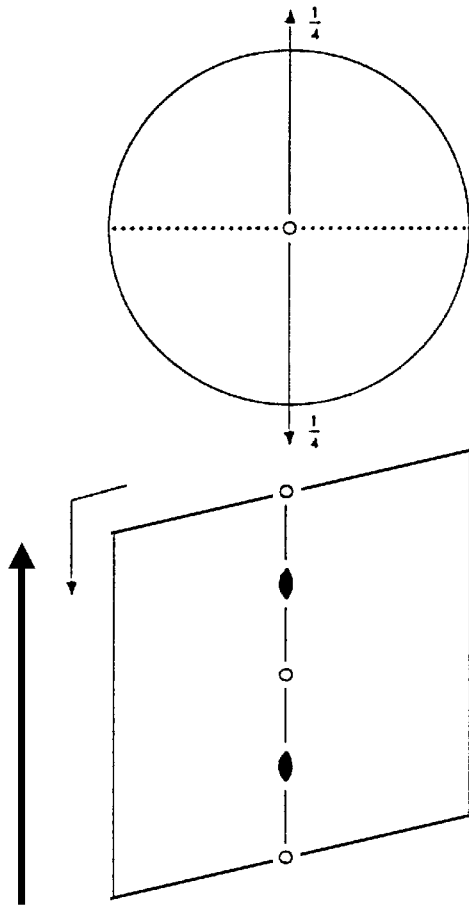

$1'$

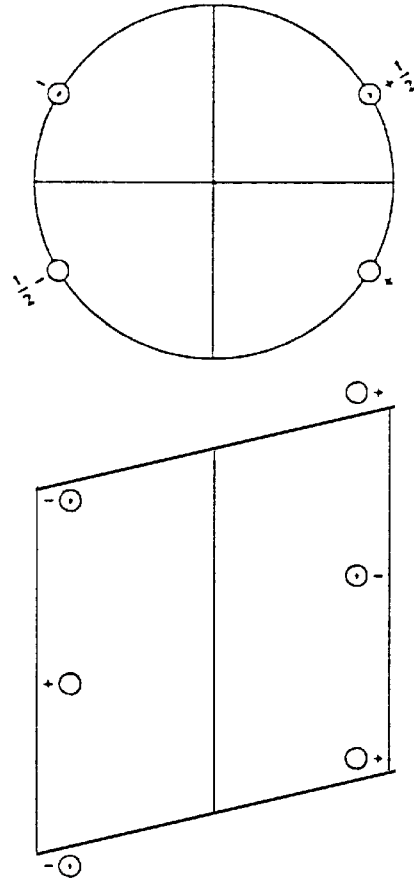

Origin at $\bar{1}1'$ on glide plane $c1'$

Asymmetric unit $0 \leq x; 0 \leq y; 0 \leq z \leq 1$

Symmetry operations

For $1 +$ set

(1) 1	(2) $2 \quad x, 0, 1/4$	(3) $\bar{1} \quad 0, 0, 0$	(4) $c \quad (0, 0, 1/2) \quad 0, y, z$
$(1 0, 0, 0)$	$(2_x 0, 0, 1/2)$	$(\bar{1} 0, 0, 0)$	$(m_x 0, 0, 1/2)$

For $1' +$ set

(1) $1'$	(2) $2' \quad x, 0, 1/4$	(3) $\bar{1}' \quad 0, 0, 0$	(4) $c' \quad (0, 0, 1/2) \quad 0, y, z$
$(1 0, 0, 0)'$	$(2_x 0, 0, 1/2)'$	$(\bar{1}' 0, 0, 0)'$	$(m_x 0, 0, 1/2)'$

Generators selected (1); $t(0,0,1)$; (2); (3); $1'$

Positions

Multiplicity, Wyckoff letter, Site symmetry	Coordinates	
		$1+$ $1'+$
4 c $11'$	(1) x,y,z [0,0,0]	(2) $x,\bar{y},\bar{z}+1/2$ [0,0,0]
	(3) \bar{x},\bar{y},\bar{z} [0,0,0]	(4) $\bar{x},y,z+1/2$ [0,0,0]
2 b $21'$	$x,0,1/4$ [0,0,0]	$\bar{x},0,3/4$ [0,0,0]
2 a $\bar{1}1'$	$0,0,0$ [0,0,0]	$0,0,1/2$ [0,0,0]

Symmetry of special projections

Along [001] $2mm1'$	Along [100] $p2111'$	Along [010] $p2mg1'$
Origin at 0,0,z	$a^* = c/2$ Origin at $x,0,0$	$a^* = c_p$ Origin at $0,y,0$

$p2/c'11$

$2/m'$

Monoclinic/Oblique

No. 7.3.29

$p2/c'11$

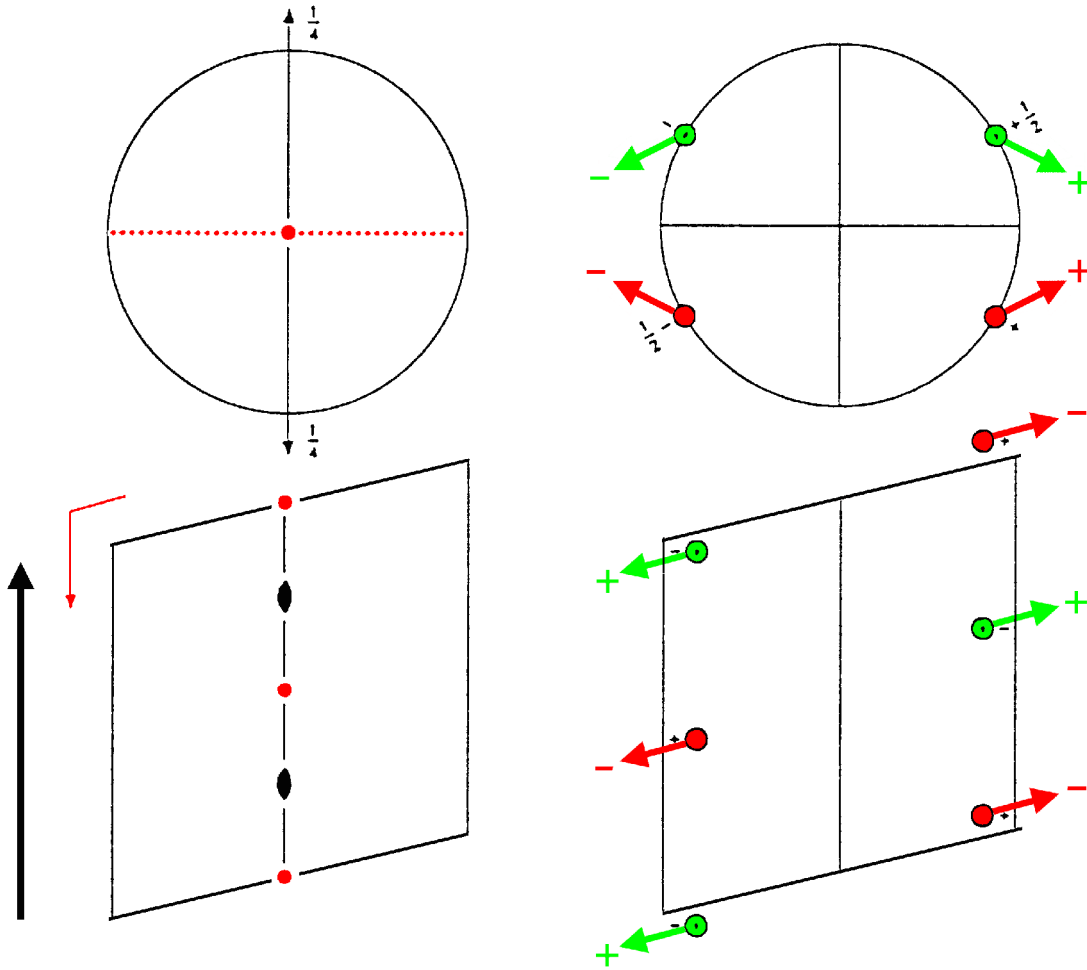

Origin at $\bar{1}$ on glide plane c'

Asymmetric unit $0 \leq x; 0 \leq y; 0 \leq z \leq 1$

Symmetry operations

- (1) 1 (2) $2_x | 0,0,1/4$ (3) $\bar{1} | 0,0,0$ (4) $c' | (0,0,1/2) | 0,y,z$
 (1|0,0,0) (2_x|0,0,1/2) ($\bar{1}$ |0,0,0)' (m_x |0,0,1/2)'

Generators selected (1); $t(0,0,1)$; (2); (3)

Positions

Multiplicity, Wyckoff letter, Site symmetry	Coordinates	
	(1) x,y,z [u,v,w]	(2) $x,\bar{y},\bar{z}+1/2$ [u,\bar{v},\bar{w}]
4 c 1	(3) \bar{x},\bar{y},\bar{z} [\bar{u},\bar{v},\bar{w}]	(4) $\bar{x},y,z+1/2$ [\bar{u},v,w]
2 b 2	$x,0,1/4$ [$u,0,0$]	$\bar{x},0,3/4$ [$\bar{u},0,0$]
2 a $\bar{1}$ '	$0,0,0$ [$0,0,0$]	$0,0,1/2$ [$0,0,0$]

Symmetry of special projections

Along [001] $2m'm'$	Along [100] $p211$	Along [010] $p2mg$
Origin at $0,0,z$	$a^* = c/2$ Origin at $x,0,0$	$a^* = c_p$ Origin at $0,y,0$

$p2'/c'11$

$2'/m'$

Monoclinic/Oblique

No. 7.4.30

$p2'/c'11$

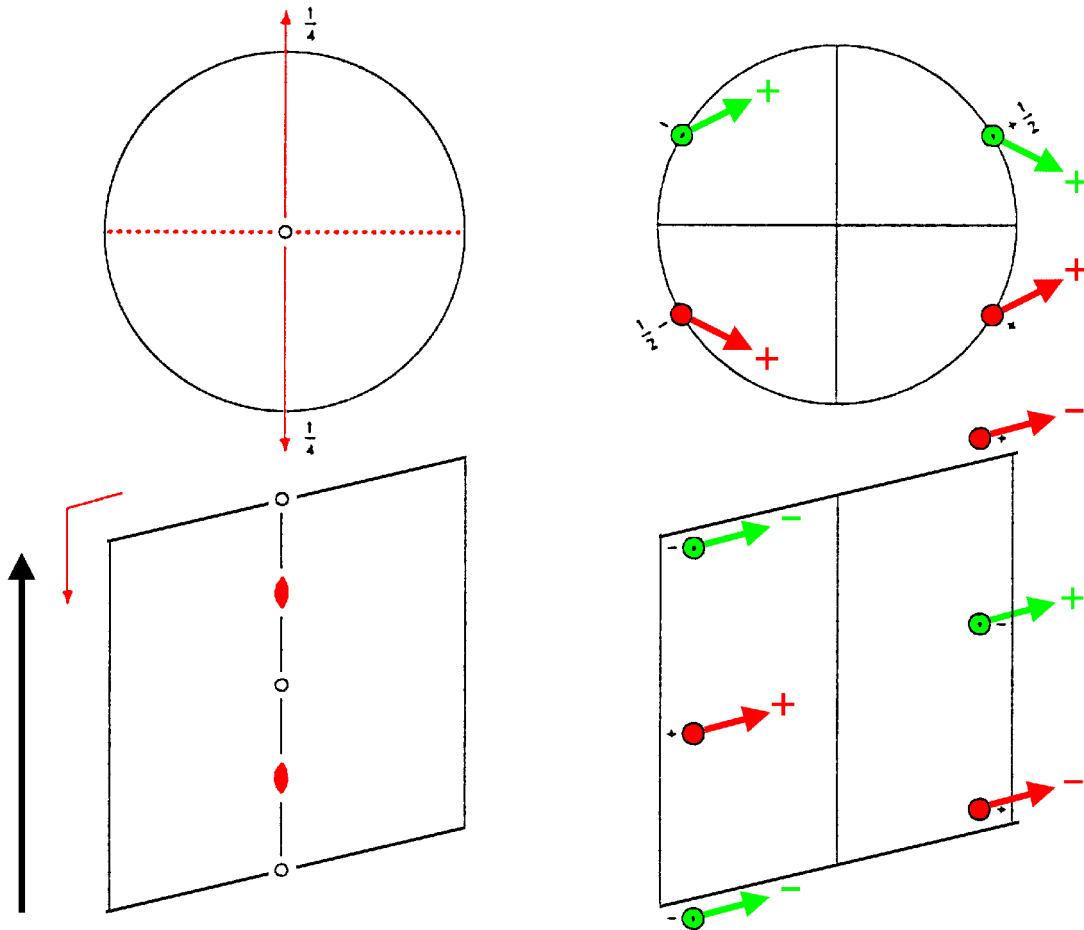

Origin at $\bar{1}$ on glide plane c'

Asymmetric unit $0 \leq x; 0 \leq y; 0 \leq z \leq 1$

Symmetry operations

- (1) 1 (2) $2' \ x,0,1/4$ (3) $\bar{1} \ 0,0,0$ (4) $c' \ (0,0,1/2) \ 0,y,z$
 (1|0,0,0) (2_x|0,0,1/2)' ($\bar{1}$ |0,0,0) (m_x |0,0,1/2)'

Generators selected (1); $t(0,0,1)$; (2); (3)

Positions

Multiplicity, Wyckoff letter, Site symmetry	Coordinates	
	(1) x,y,z [u,v,w]	(2) $x,\bar{y},\bar{z}+1/2$ [\bar{u},v,w]
4 c 1	(3) \bar{x},\bar{y},\bar{z} [u,v,w]	(4) $\bar{x},y,z+1/2$ [\bar{u},v,w]
2 b 2'	$x,0,1/4$ [0,v,w]	$\bar{x},0,3/4$ [0,v,w]
2 a $\bar{1}$	$0,0,0$ [u,v,w]	$0,0,1/2$ [\bar{u},v,w]

Symmetry of special projections

Along [001] $2'm'm$	Along [100] $p2'11$	Along [010] $p2'mg'$
Origin at 0,0,z	$a^* = c/2$ Origin at x,0,0	$a^* = c_p$ Origin at 0,y,0

$p2'/c11$

$2'/m$

Monoclinic/Oblique

No. 7.5.31

$p2'/c11$

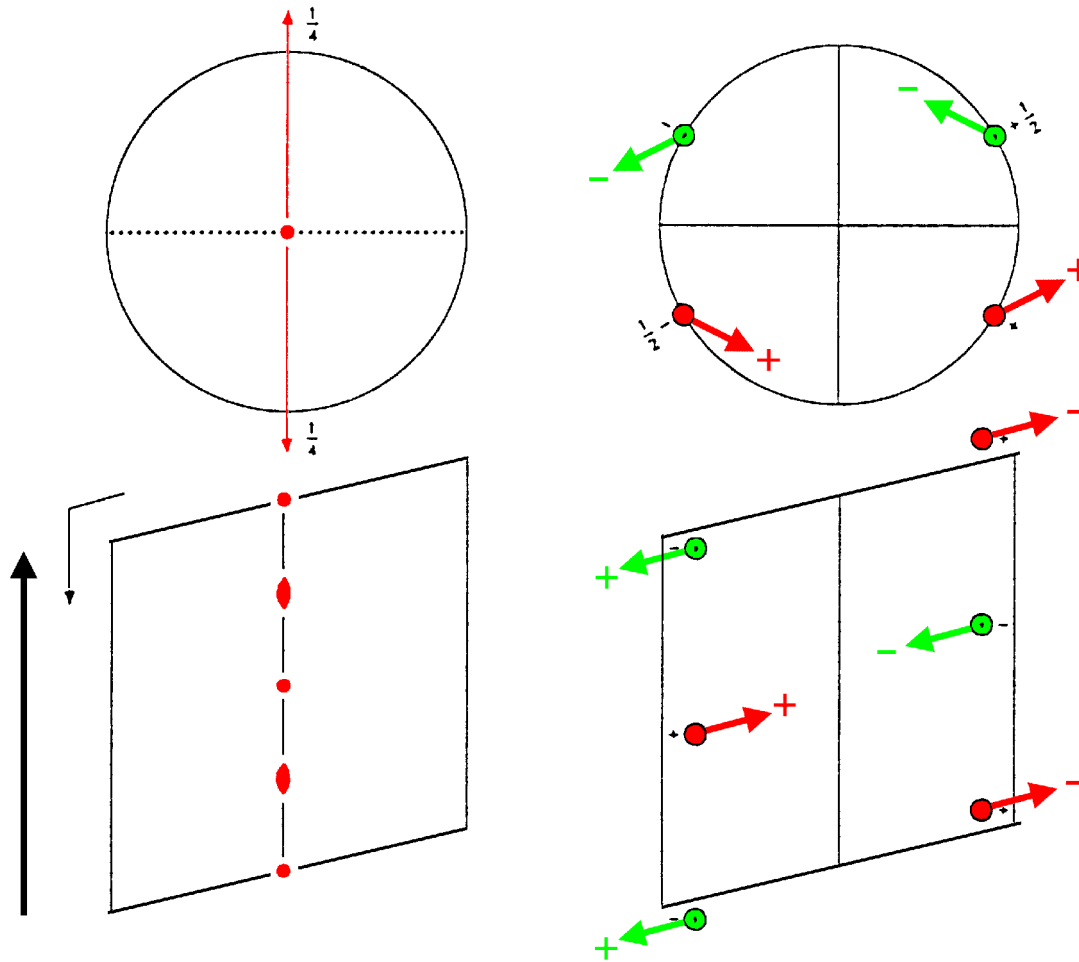

Origin at $\bar{1}$ on glide plane c

Asymmetric unit $0 \leq x; 0 \leq y; 0 \leq z \leq 1$

Symmetry operations

- (1) 1 (1|0,0,0) (2) $2'$ $x,0,1/4$ ($2_x|0,0,1/2$)' (3) $\bar{1}$ $0,0,0$ ($\bar{1}|0,0,0$)' (4) c $(0,0,1/2)$ $0,y,z$ ($m_x|0,0,1/2$)

Generators selected (1); $t(0,0,1)$; (2); (3)

Positions

Multiplicity, Wyckoff letter, Site symmetry	Coordinates	
	(1) x,y,z [u,v,w]	(2) $x,\bar{y},\bar{z}+1/2$ [\bar{u},v,w]
4 c 1	(3) \bar{x},\bar{y},\bar{z} [\bar{u},\bar{v},\bar{w}]	(4) $\bar{x},y,z+1/2$ [u,\bar{v},\bar{w}]
2 b 2'	$x,0,1/4$ [0,v,w]	$\bar{x},0,3/4$ [0, \bar{v},\bar{w}]
2 a $\bar{1}$ '	0,0,0 [0,0,0]	0,0,1/2 [0,0,0]

Symmetry of special projections

Along [001] 2mm	Along [100] $p_{2a^*}211$	Along [010] $p2mg$
Origin at 0,0,z	$a^* = c/2$ Origin at x,0,0	$a^* = c_p$ Origin at 0,y,0

$p112$

2

Monoclinic/Rectangular

No. 8.1.32

$p112$

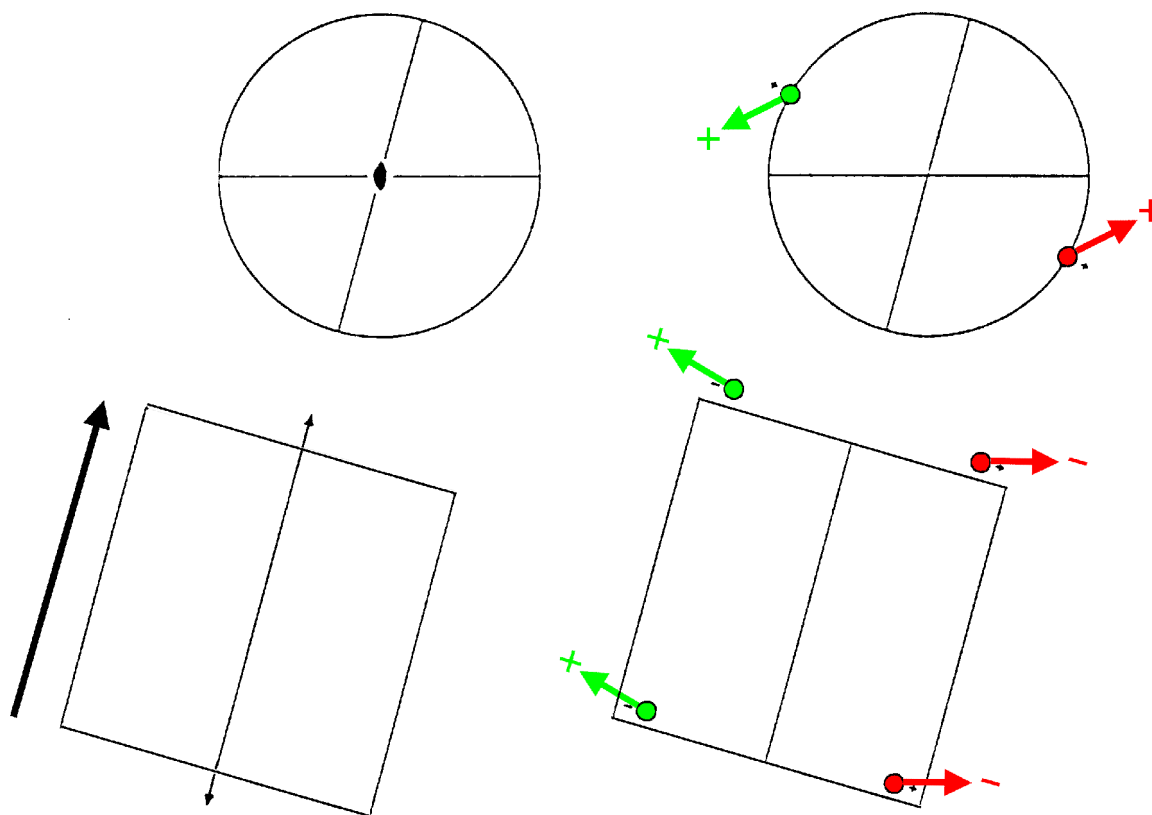

Origin on 2

Asymmetric unit $0 \leq x; 0 \leq z \leq 1$

Symmetry operations

(1) 1
(1|0,0,0)

(2) 2 0,0,z
(2_z|0,0,0)

Generators selected (1); $t(0,0,1)$; (2)

Positions

		Coordinates	
		Multiplicity, Wyckoff letter, Site symmetry	
2	b 1	(1) $x,y,z [u,v,w]$	(2) $\bar{x},\bar{y},z [\bar{u},\bar{v},w]$
1	a 2	$0,0,z [0,0,w]$	

Symmetry of special projections

Along [001] 211	Along [100] $p11m'$ $a^* = c$	Along [010] $p11m'$ $a^* = c$
Origin at $0,0,z$	Origin at $x,0,0$	Origin at $0,y,0$

$p1121'$

$21'$

Monoclinic/Rectangular

No. 8.2.33

$p1121'$

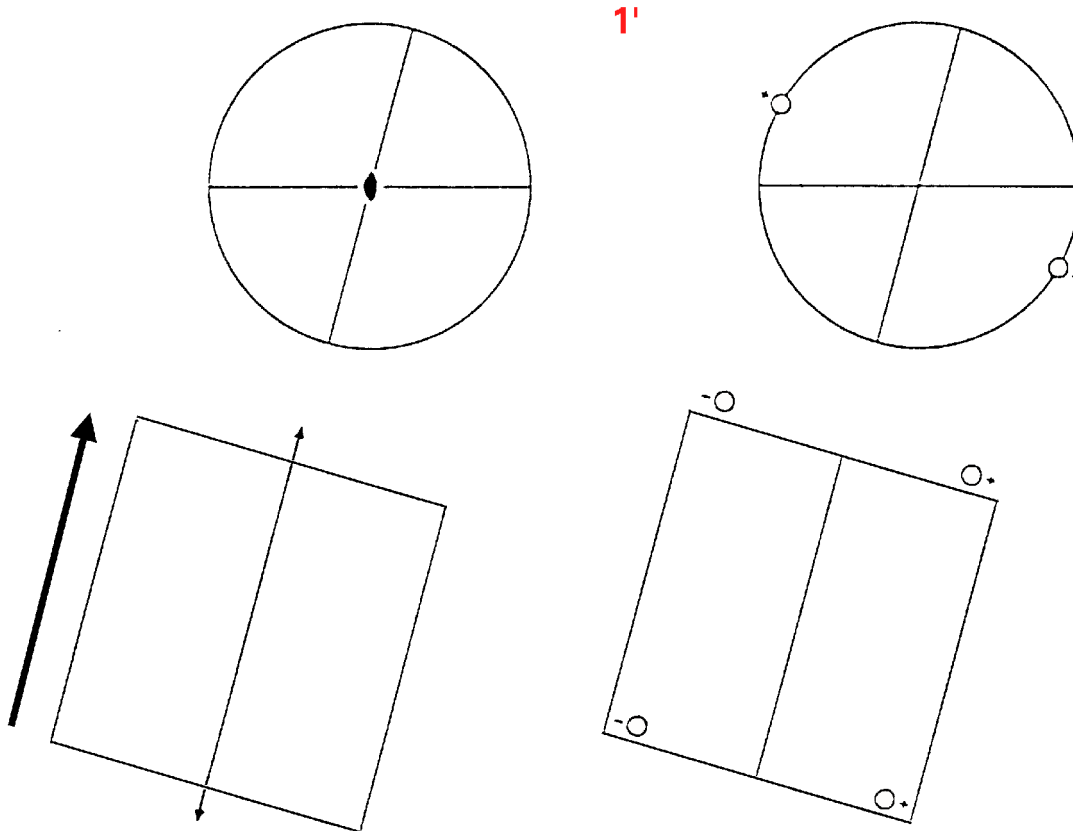

Origin on $21'$

Asymmetric unit $0 \leq x; 0 \leq z \leq 1$

Symmetry operations

1 + set
(1) 1 (2) $2 \ 0,0,z$
(1|0,0,0) (2_z|0,0,0)

1' + set
(1) 1' (2) $2' \ 0,0,z$
(1|0,0,0)' (2'_z|0,0,0)'

Generators selected (1); $t(0,0,1)$; (2); $1'$

Positions

		Coordinates	
Multiplicity, Wyckoff letter, Site symmetry		$1+$	$1'+$
2	$b\ 11'$	(1) $x,y,z\ [0,0,0]$	(2) $\bar{x},\bar{y},z\ [0,0,0]$
1	$a\ 21'$	$0,0,z\ [0,0,0]$	

Symmetry of special projections

Along $[001]\ 2111'$	Along $[100]\ p11m1'$	Along $[010]\ p11m1'$
Origin at $0,0,z$	$a^* = c$ Origin at $x,0,0$	$a^* = c$ Origin at $0,y,0$

$p112'$

$2'$

Monoclinic/Rectangular

No. 8.3.34

$p112'$

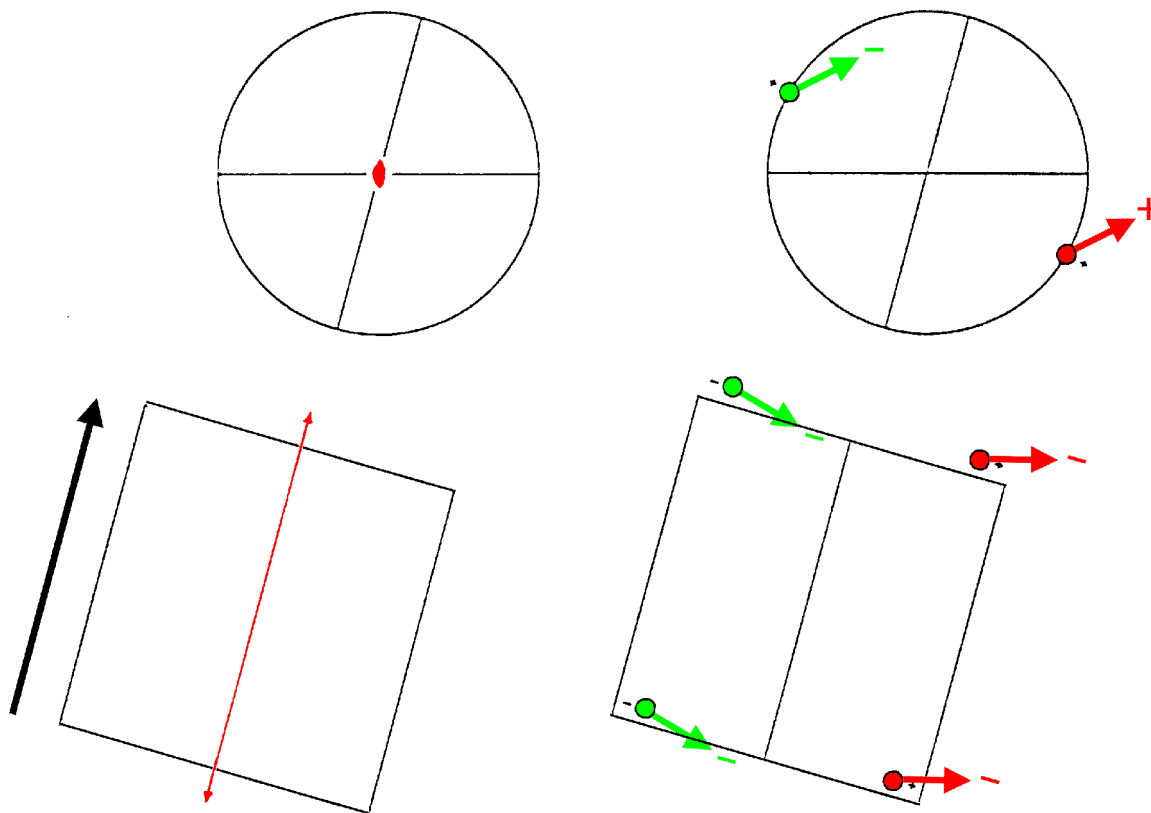

Origin on $2'$

Asymmetric unit $0 \leq x; 0 \leq z \leq 1$

Symmetry operations

(1) 1
(1|0,0,0)

(2) $2'_z$ 0,0,z
($2'_z$ |0,0,0)'

Generators selected (1); $t(0,0,1)$; (2)

Positions

	Coordinates	
Multiplicity, Wyckoff letter, Site symmetry		
2 b 1	(1) $x,y,z [u,v,w]$	(2) $\bar{x},\bar{y},z [u,v,\bar{w}]$
1 a 2'	$0,0,z [u,v,0]$	

Symmetry of special projections

Along [001] $2'11$	Along [100] $p11m$	Along [010] $p11m$
	$a^* = c$	$a^* = c$
Origin at $0,0,z$	Origin at $x,0,0$	Origin at $0,y,0$

$p_{2c}112'$

$21'$

Monoclinic/Rectangular

No. 8.4.35

$p_{2c}112$

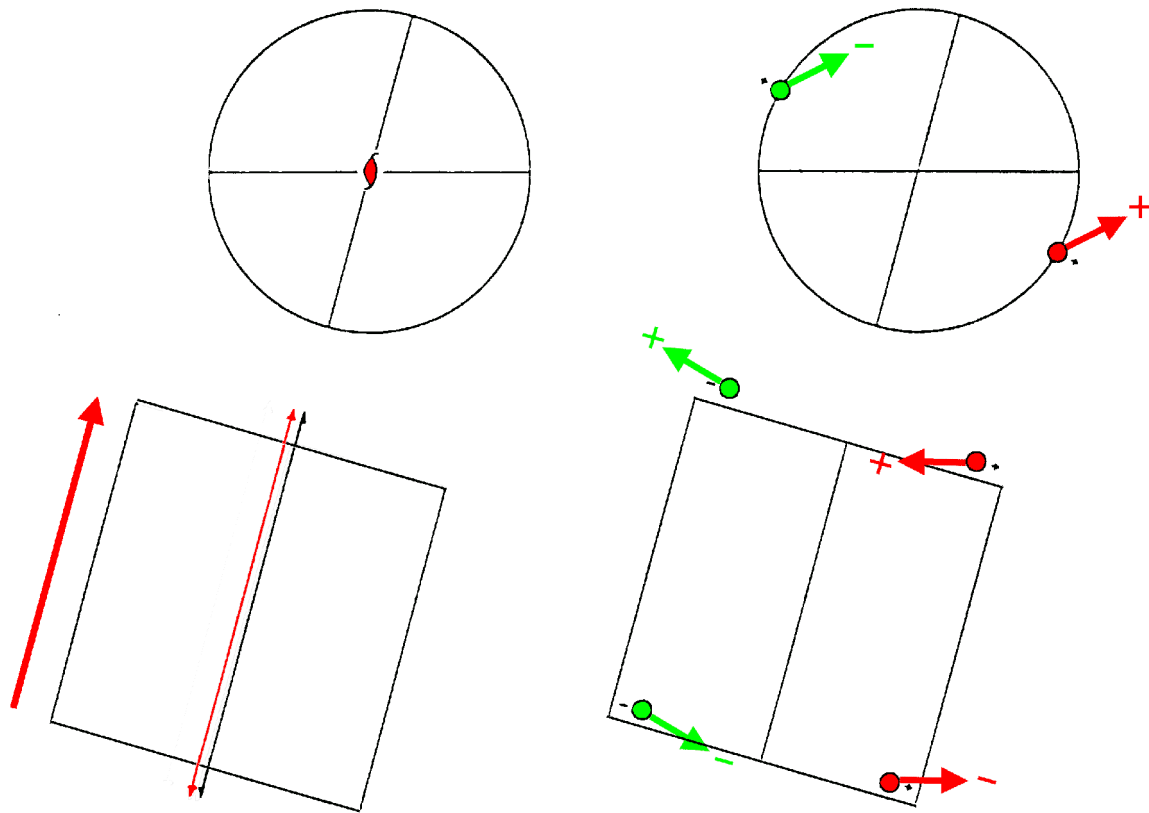

Origin on $2'$

Asymmetric unit $0 \leq x$; $0 \leq z \leq 1$

Symmetry operations

For $(0,0,0)$ + set
 (1) 1 (2) $2' \ 0,0,z$
 (1| $0,0,0$) (2_z| $0,0,0$)'

For $(0,0,1)'$ + set
 (1) $t' \ (0,0,1)$ (2) $2 \ (0,0,1) \ 0,0,z$
 (1| $0,0,1$)' (2_z| $0,0,1$)

Generators selected (1); $t(0,0,1)'$; (2)

Positions

		Coordinates	
Multiplicity, Wyckoff letter, Site symmetry		(0,0,0)+	(0,0,1)' +
2 b 1	(1) x,y,z [u,v,w]	(2) \bar{x},\bar{y},z [u,v, \bar{w}]	
1 a 2'	0,0,z [u,v,0]		

Symmetry of special projections

Along [001] $2111'$	Along [100] $P_{2a^*}11m$ $a^* = c$	Along [010] $P_{2a^*}11m$ $a^* = c$
Origin at 0,0,z	Origin at x,0,0	Origin at 0,y,0

$p_{2c}112$

21'

Monoclinic/Rectangular

No. 8.5.36

$p_{2c}112$

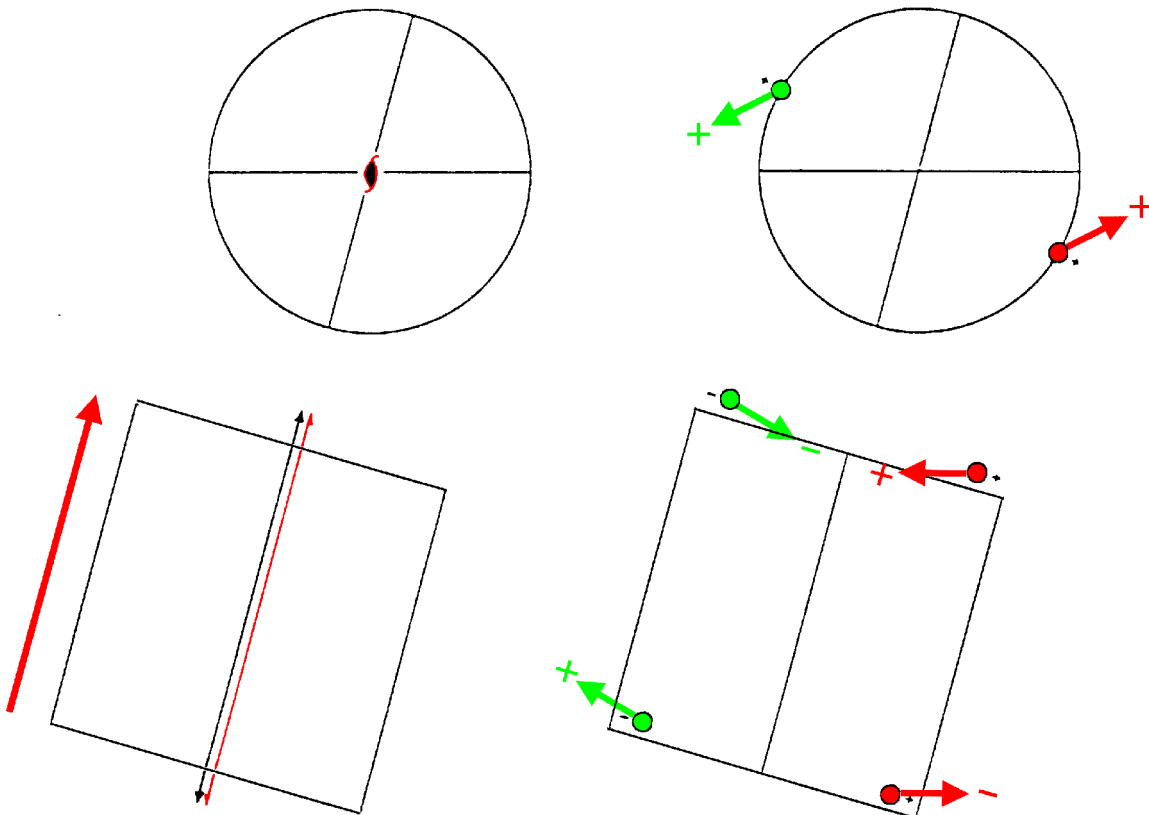

Origin on 2

Asymmetric unit $0 \leq x; 0 \leq z \leq 1$

Symmetry operations

For $(0,0,0)$ + set
 (1) 1 (2) $2 \ 0,0,z$
 (1| $0,0,0$) (2_z| $0,0,0$)

For $(0,0,1)'$ + set
 (1) $t' \ (0,0,1)$ (2) $2' \ (0,0,1) \ 0,0,z$
 (1| $0,0,1$) (2_z| $0,0,1$)'

Generators selected (1); $t(0,0,1)'$; (2)

Positions

		Coordinates	
Multiplicity, Wyckoff letter, Site symmetry		(0,0,0)+	(0,0,1)' +
2	b 1	(1) $x,y,z [u,v,w]$	(2) $\bar{x},\bar{y},z [\bar{u},\bar{v},w]$
1	a 2	$0,0,z [0,0,w]$	

Symmetry of special projections

Along [001] $2111'$	Along [100] $p_{2a^*}11m'$	Along [010] $p_{2a^*}11m'$
Origin at 0,0,z	$a^* = c$ Origin at x,0,0	$a^* = c$ Origin at 0,y,0

$p112_1$

2

Monoclinic/Rectangular

No. 9.1.37

$p112_1$

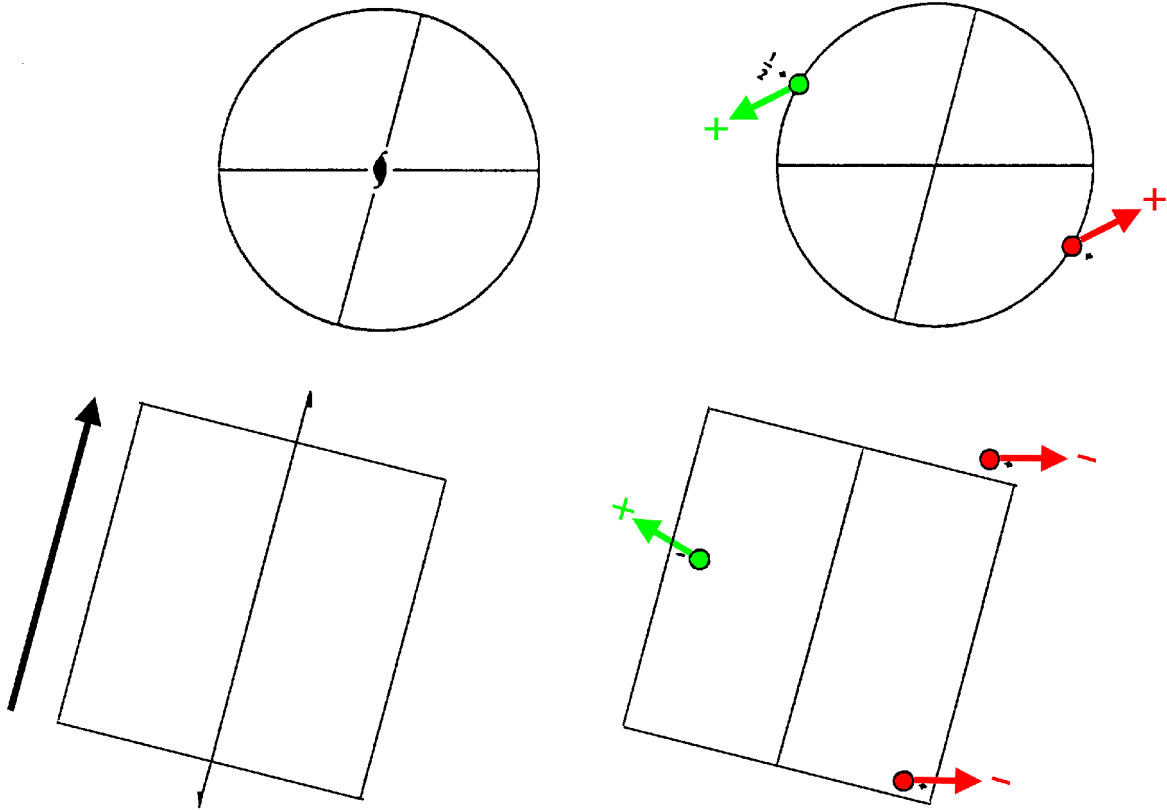

Origin on 2_1

Asymmetric unit $0 \leq x; 0 \leq z \leq 1$

Symmetry operations

(1) 1
(1|0,0,0)

(2) 2 (0,0,1/2) 0,0,z
(2_z|0,0,1/2)

Generators selected (1); $t(0,0,1)$; (2)

Positions

	Coordinates	
Multiplicity, Wyckoff letter, Site symmetry		
2 a 1	(1) $x,y,z [u,v,w]$	(2) $\bar{x},\bar{y},z+1/2 [\bar{u},\bar{v},w]$

Symmetry of special projections

Along [001] 211	Along [100] $p11g'$ $a^* = c$	Along [010] $p11g$ $a^* = c$
Origin at 0,0,z	Origin at x,0,0	Origin at 0,y,0

$p112_11'$

$21'$

Monoclinic/Rectangular

No. 9.2.38

$p112_11'$

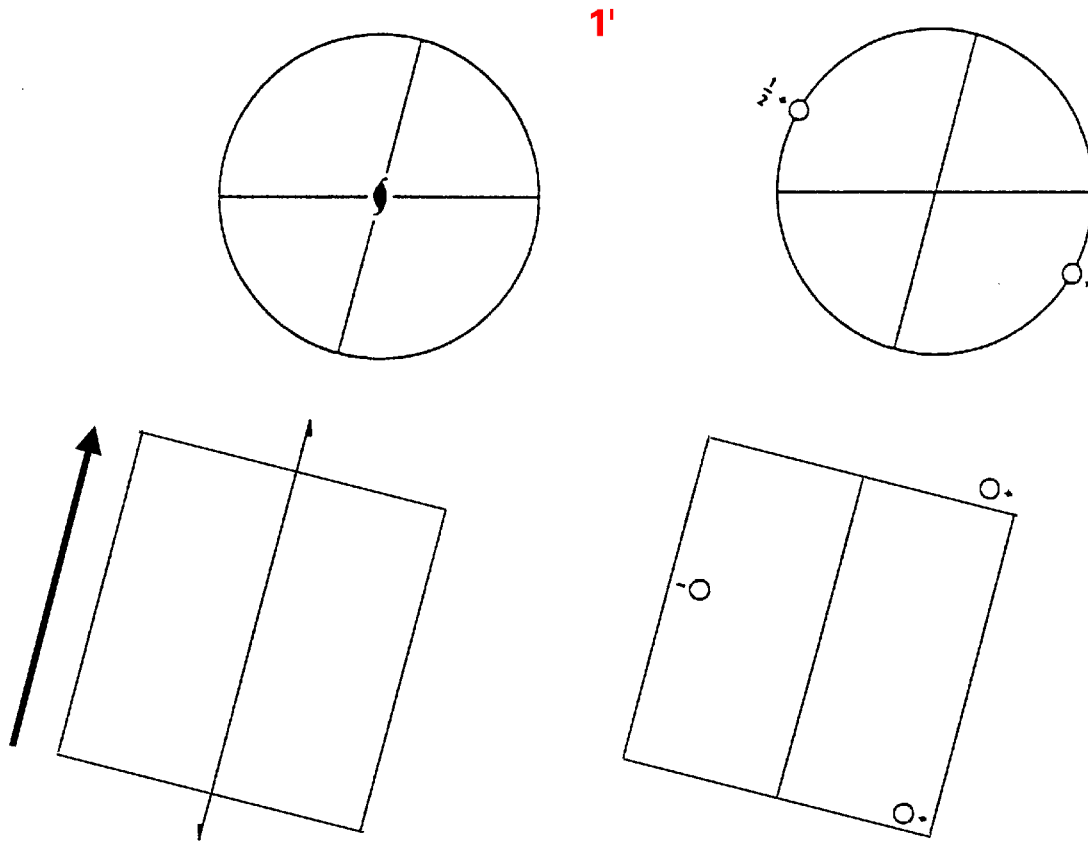

Origin on $2_11'$

Asymmetric unit $0 \leq x; 0 \leq z \leq 1$

Symmetry operations

1 + set
 (1) 1 (2) 2 (0,0,½) 0,0,z
 (1|0,0,0) (2_z|0,0,½)

1' + set
 (1) 1' (2) 2' (0,0,½) 0,0,z
 (1|0,0,0)' (2_z|0,0,½)'

Continued

No. 9.2.38

$p112_11'$

Generators selected (1); $t(0,0,1)$; (2); $1'$

Positions

Multiplicity, Wyckoff letter, Site symmetry	Coordinates	
	1+	1' +
2 a 11'	(1) x,y,z [0,0,0]	(2) $\bar{x},\bar{y},z+1/2$ [0,0,0]

Symmetry of special projections

Along [001] $2111'$	Along [100] $p11g1'$	Along [010] $p11g1'$
Origin at 0,0,z	$a^* = c$ Origin at x,0,0	$a^* = c$ Origin at 0,y,0

$p112_1'$

$2'$

Monoclinic/Rectangular

No. 9.3.39

$p112_1'$

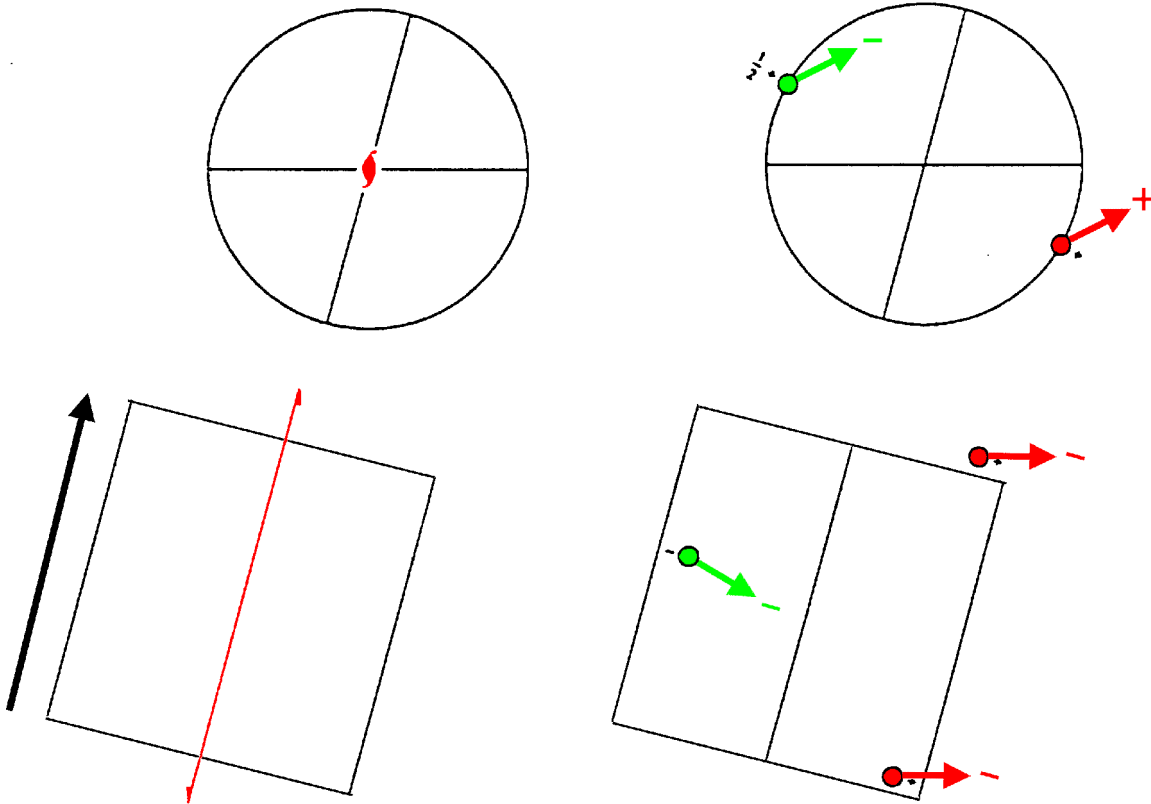

Origin on $2_1'$

Asymmetric unit $0 \leq x; 0 \leq z \leq 1$

Symmetry operations

- (1) 1
- (1|0,0,0)
- (2) $2' (0,0, \frac{1}{2})$ $0,0,z$
- ($2_z|0,0, \frac{1}{2}$)'

Generators selected (1); $t(0,0,1)$; (2)

Positions

	Coordinates	
Multiplicity, Wyckoff letter, Site symmetry		
2 a 1	(1) $x,y,z [u,v,w]$	(2) $\bar{x},\bar{y},z+1/2 [u,v,\bar{w}]$

Symmetry of special projections

Along [001] $2'11$	Along [100] $p11g$ $a^* = c$	Along [010] $p11g$ $a^* = c$
Origin at 0,0,z	Origin at x,0,0	Origin at 0,y,0

$p11m$

m

Monoclinic/Rectangular

No. 10.1.40

$p11m$

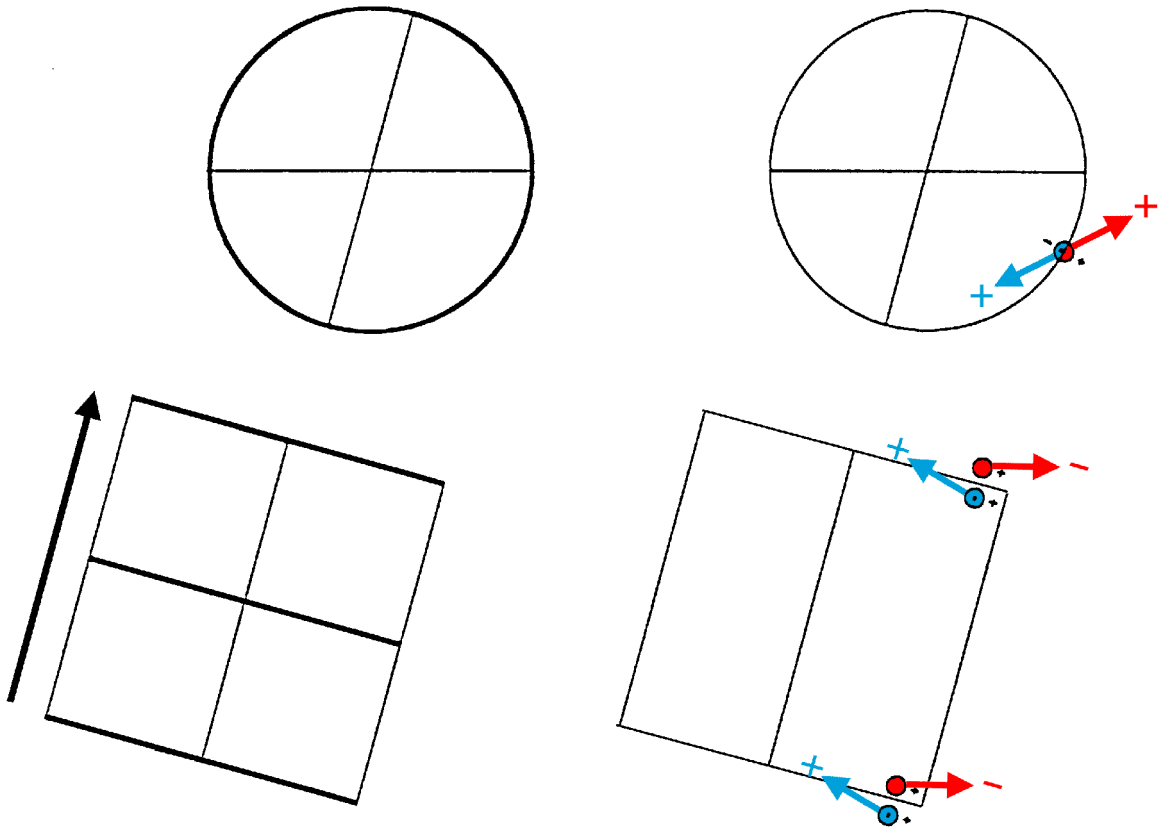

Origin on mirror plane m

Asymmetric unit $0 \leq z \leq 1/2$

Symmetry operations

(1) 1 (2) $m \quad x,y,0$
($1|0,0,0$) ($m_z|0,0,0$)

Generators selected (1); $t(0,0,1)$; (2)

Positions

		Coordinates	
Multiplicity, Wyckoff letter, Site symmetry			
2 c 1	(1) x,y,z [u,v,w]	(2) x,y,\bar{z} [\bar{u},\bar{v},w]	
1 b m	$x,y,1/2$ [0,0,w]		
1 a m	$x,y,0$ [0,0,w]		

Symmetry of special projections

Along [001] $11'$	Along [100] $p1m1$	Along [010] $p1m1$
Origin at 0,0,z	$a^* = c$ Origin at x,0,0	$a^* = c$ Origin at 0,y,0

$p11m1'$

$m1'$

Monoclinic/Rectangular

No. 10.2.41

$p11m1'$

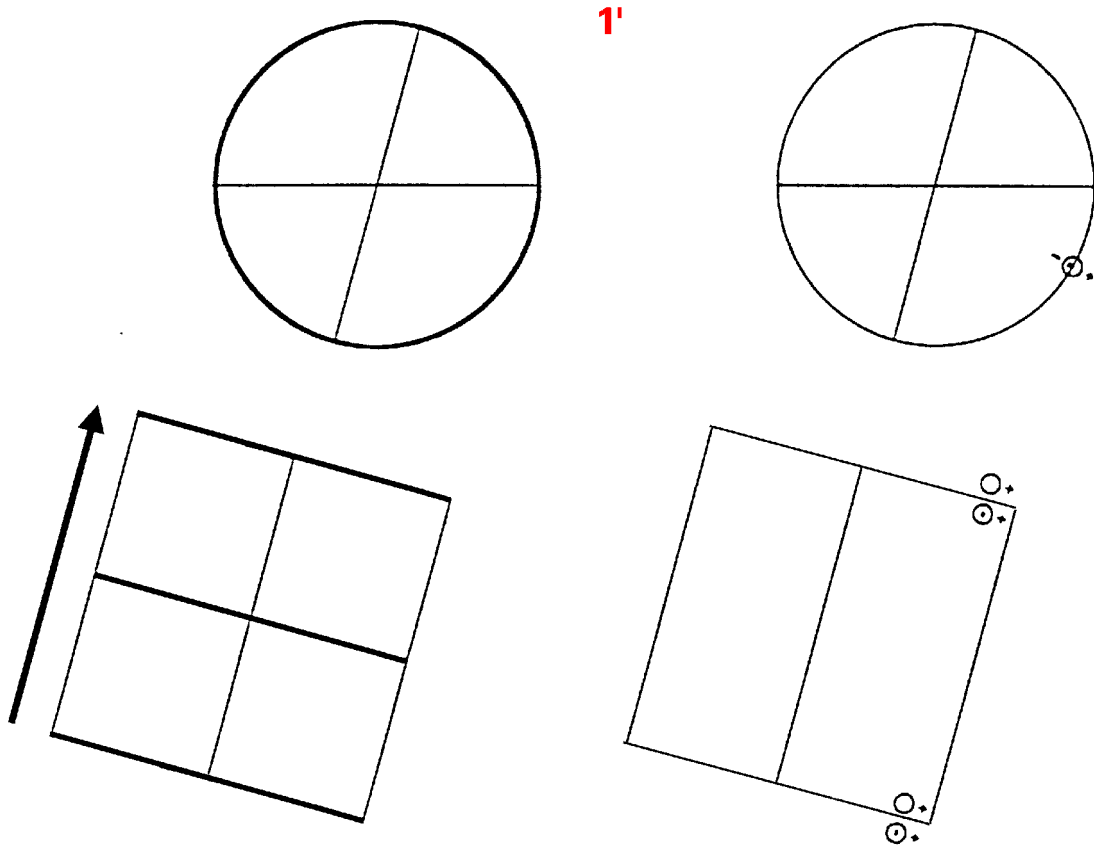

Origin on mirror plane $m1'$

Asymmetric unit $0 \leq z \leq 1/2$

Symmetry operations

For 1 + set

(1) 1	(2) $m \ x,y,0$
$(1 0,0,0)$	$(m_z 0,0,0)$

For $1'$ + set

(1) $1'$	(2) $m' \ x,y,0$
$(1 0,0,0)'$	$(m_z 0,0,0)'$

Continued

No. 10.2.41

$p11m1'$

Generators selected (1); $t(0,0,1)$; (2); $1'$

Positions

		Coordinates	
Multiplicity, Wyckoff letter, Site symmetry		1+	1' +
2 c 11'	(1) x,y,z [0,0,0]	(2) x,y,\bar{z} [0,0,0]	
1 b $m1'$	$x,y,1/2$ [0,0,0]		
1 a $m1'$	$x,y,0$ [0,0,0]		

Symmetry of special projections

Along [001] $11'$	Along [100] $p1m11'$	Along [010] $p1m11'$
Origin at 0,0,z	$a^* = c$ Origin at $x,0,0$	$a^* = c$ Origin at $0,y,0$

$p11m'$

No. 10.3.42

m'

$p11m'$

Monoclinic/Rectangular

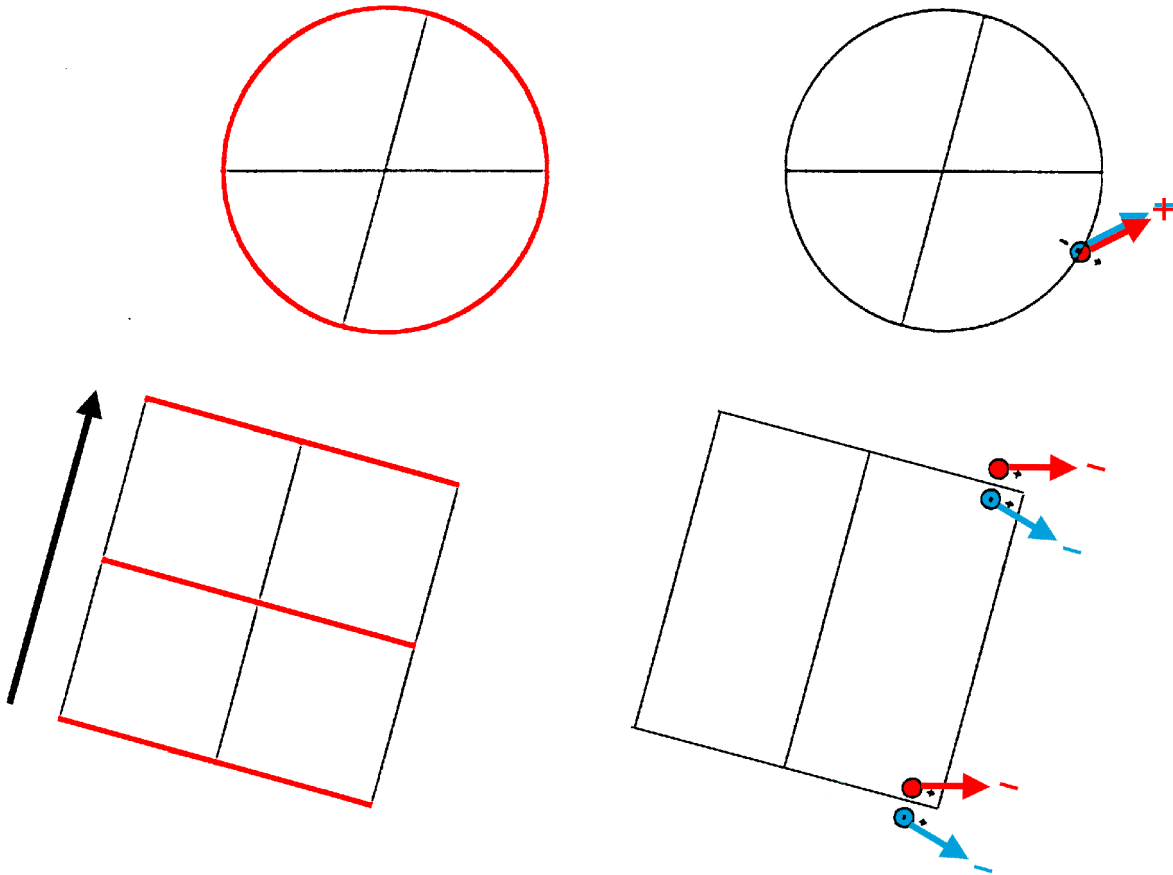

Origin on mirror plane m'

Asymmetric unit $0 \leq z \leq 1/2$

Symmetry operations

(1) 1 (2) m' $x, y, 0$
(1|0,0,0) (m_z |0,0,0)

Generators selected (1); $t(0,0,1)$; (2)

Positions

	Coordinates	
Multiplicity, Wyckoff letter, Site symmetry		
2 c 1	(1) x,y,z [u,v,w]	(2) x,y,\bar{z} [u,v, \bar{w}]
1 b m'	$x,y,1/2$ [u,v,0]	
1 a m'	$x,y,0$ [u,v,0]	

Symmetry of special projections

Along [001] 1	Along [100] $p1m'1$ $a^* = c$	Along [010] $p1m'1$ $a^* = c$
Origin at 0,0,z	Origin at x,0,0	Origin at 0,y,0

$p_{2c}11m$

$m1'$

Monoclinic/Rectangular

No. 10.4.43

$p_{2c}11m$

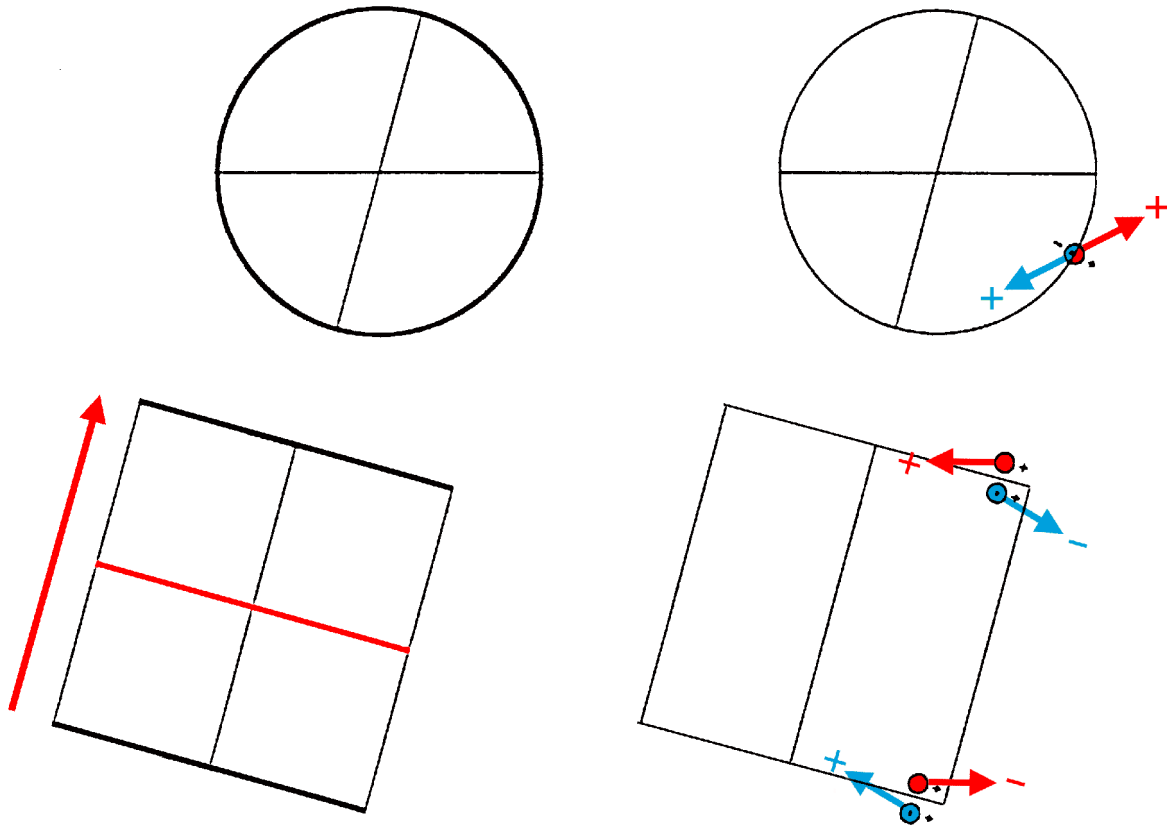

Origin on mirror plane m

Asymmetric unit $0 \leq z \leq 1/2$

Symmetry operations

For $(0,0,0)$ + set

(1) 1	(2) $m \ x,y,0$
$(1 0,0,0)$	$(m_z 0,0,0)$

For $(0,0,1)'$ + set

(1) $t' (0,0,1)$	(2) $m' \ x,y,1/2$
$(1 0,0,1)'$	$(m_z 0,0,1)'$

Generators selected (1); $t(0,0,1)'$; (2)

Positions

		Coordinates	
Multiplicity, Wyckoff letter, Site symmetry		(0,0,0)+	(0,0,1)' +
2	c 1	(1) x,y,z [u,v,w]	(2) x,y,\bar{z} [\bar{u},\bar{v},w]
1	b m'	$x,y,1/2$ [u,v,0]	
1	a m	$x,y,0$ [0,0,w]	

Symmetry of special projections

Along [001] $11'$	Along [100] $p_{2a^*}1m1$	Along [010] $p_{2a^*}1m1$
	$a^* = c$	$a^* = c$
Origin at 0,0,z	Origin at x,0,0	Origin at 0,y,0

$p112/m$

$2/m$

Monoclinic/Rectangular

No. 11.1.44

$p112/m$

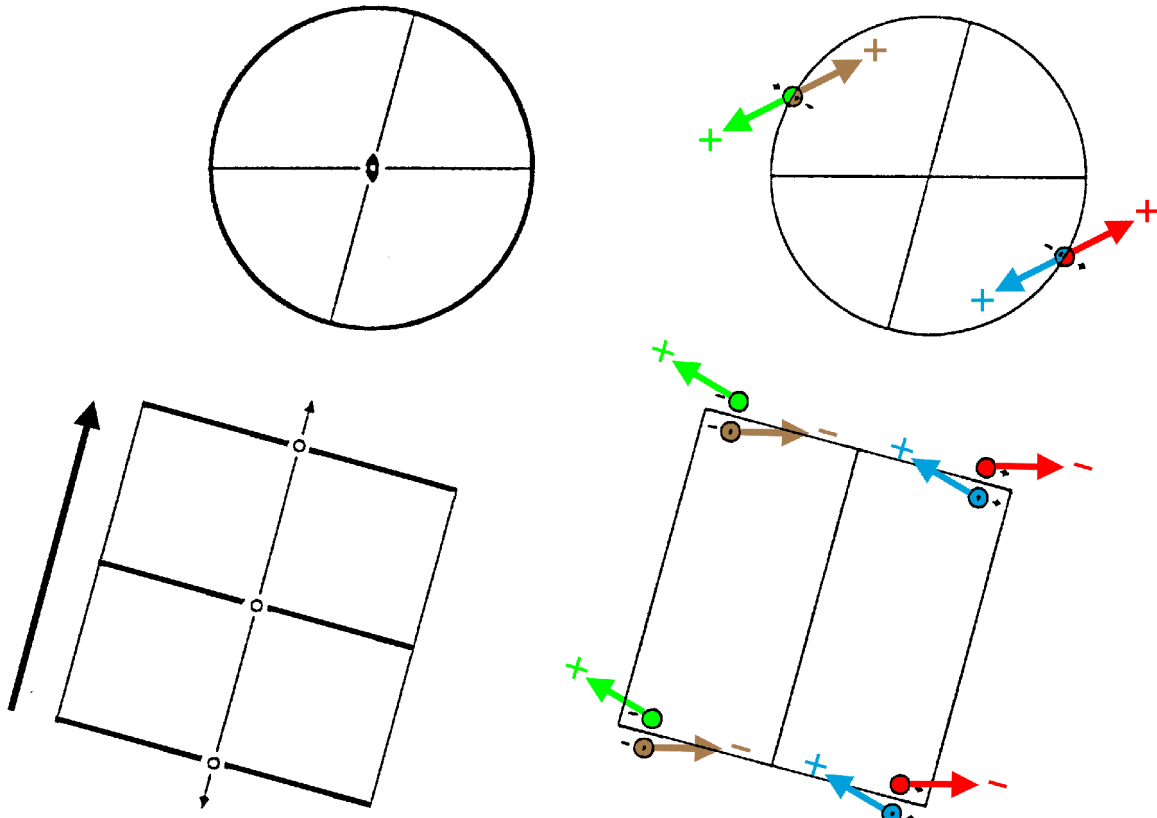

Origin at center $2/m$

Asymmetric unit $0 \leq y$; $0 \leq z \leq 1/2$

Symmetry operations

(1) 1 (2) $2 \ 0,0,z$ (3) $\bar{1} \ 0,0,0$ (4) $m \ x,y,0$
(1|0,0,0) (2_z|0,0,0) ($\bar{1}$ |0,0,0) (m_z |0,0,0)

Generators selected (1); $t(0,0,1)$; (2); (3)

Positions

Multiplicity, Wyckoff letter, Site symmetry	Coordinates	
	(1) x,y,z [u,v,w]	(2) \bar{x},\bar{y},z [\bar{u},\bar{v},w]
4 f 1	(1) x,y,z [u,v,w]	(2) \bar{x},\bar{y},z [\bar{u},\bar{v},w]
	(3) \bar{x},\bar{y},\bar{z} [u,v,w]	(4) x,y,\bar{z} [\bar{u},\bar{v},w]
2 e m	$x,y,1/2$ [0,0,w]	$\bar{x},\bar{y},1/2$ [0,0,w]
2 d m	$x,y,0$ [0,0,w]	$\bar{x},\bar{y},0$ [0,0,w]
2 c 2	$0,0,z$ [0,0,w]	$0,0,\bar{z}$ [0,0,w]
1 b $2/m$	$0,0,1/2$ [0,0,w]	
1 a $2/m$	$0,0,0$ [0,0,w]	

Symmetry of special projections

Along [001] $2111'$	Along [100] $p2'mm'$	Along [010] $p2'mm'$
Origin at 0,0,z	$a^* = c$ Origin at x,0,0	$a^* = c$ Origin at 0,y,0

$p112/m1'$

$2/m1'$

Monoclinic/Rectangular

No. 11.2.45

$p112/m1'$

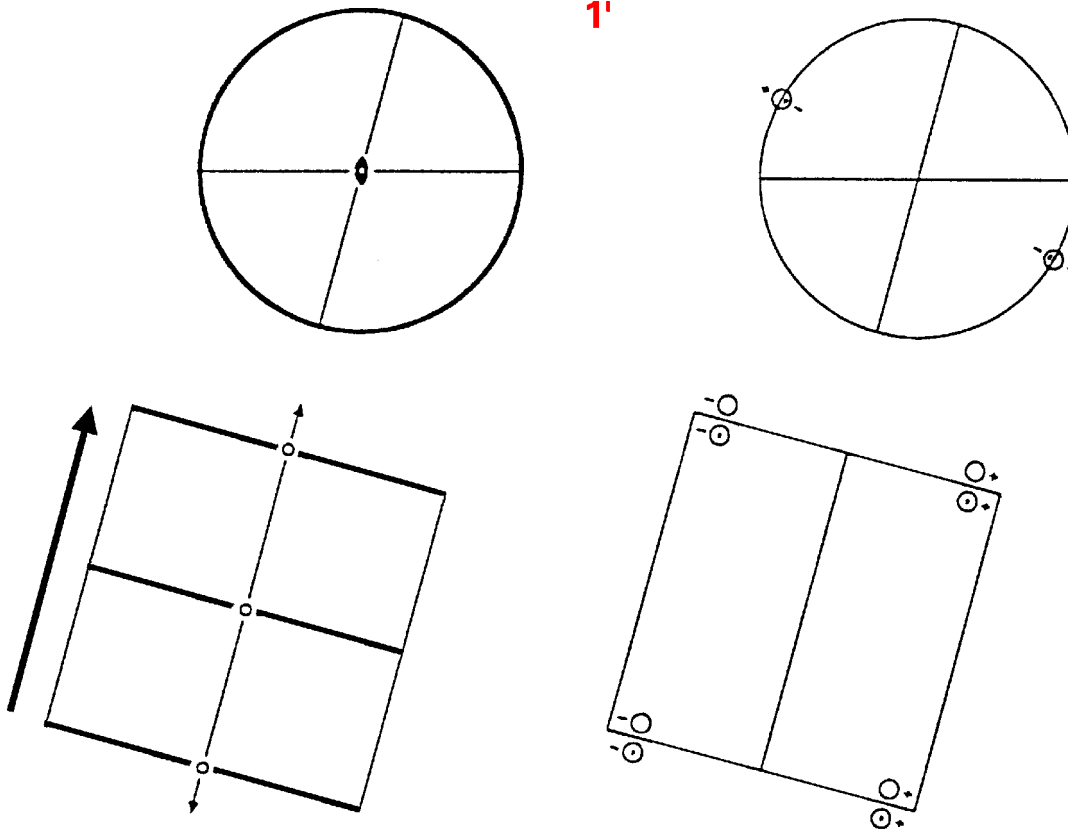

Origin at center $2/m1'$

Asymmetric unit $0 \leq y$; $0 \leq z \leq 1/2$

Symmetry operations

For 1 + set

(1) 1	(2) $2 \quad 0,0,z$	(3) $\bar{1} \quad 0,0,0$	(4) $m \quad x,y,0$
$(1 0,0,0)$	$(2_z 0,0,0)$	$(\bar{1} 0,0,0)$	$(m_z 0,0,0)$

For 1' + set

(1) $1'$	(2) $2' \quad 0,0,z$	(3) $\bar{1}' \quad 0,0,0$	(4) $m' \quad x,y,0$
$(1 0,0,0)'$	$(2_z 0,0,0)'$	$(\bar{1}' 0,0,0)'$	$(m_z 0,0,0)'$

Generators selected (1); $t(0,0,1)$; (2); (3); $1'$

Positions

Multiplicity, Wyckoff letter, Site symmetry	Coordinates	
	$1+$	$1' +$
4 f $11'$	(1) $x,y,z [0,0,0]$	(2) $\bar{x},\bar{y},z [0,0,0]$
	(3) $\bar{x},\bar{y},\bar{z} [0,0,0]$	(4) $x,y,\bar{z} [0,0,0]$
2 e $m1'$	$x,y,1/2 [0,0,0]$	$\bar{x},\bar{y},1/2 [0,0,0]$
2 d $m1'$	$x,y,0 [0,0,0]$	$\bar{x},\bar{y},0 [0,0,0]$
2 c $21'$	$0,0,z [0,0,0]$	$0,0,\bar{z} [0,0,0]$
1 b $2/m1'$	$0,0,1/2 [0,0,0]$	
1 a $2/m1'$	$0,0,0 [0,0,0]$	

Symmetry of special projections

Along [001] $2111'$	Along [100] $p2mm1'$	Along [010] $p2mm1'$
Origin at $0,0,z$	$a^* = c$ Origin at $x,0,0$	$a^* = c$ Origin at $0,y,0$

$p112/m'$

$2/m'$

Monoclinic/Rectangular

No. 11.3.46

$p112/m'$

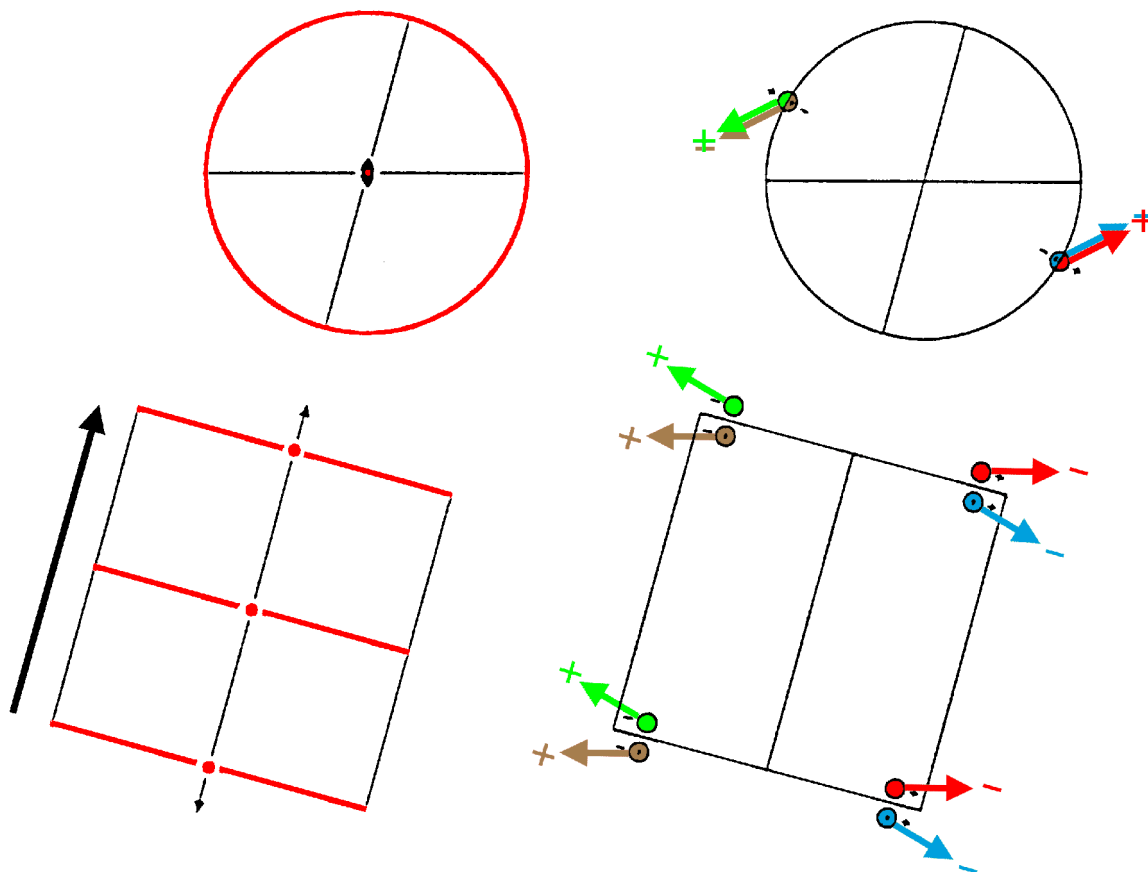

Origin at center $2/m'$

Asymmetric unit $0 \leq y; 0 \leq z \leq 1/2$

Symmetry operations

- | | | | |
|-------------|-------------------|-------------------------|-----------------|
| (1) 1 | (2) $2_{z 0,0,z}$ | (3) $\bar{1}'_{ 0,0,0}$ | (4) $m'_x y,0$ |
| $(1 0,0,0)$ | $(2_z 0,0,0)$ | $(\bar{1}' 0,0,0)'$ | $(m'_z 0,0,0)'$ |

Generators selected (1); $t(0,0,1)$; (2); (3)

Positions

Multiplicity, Wyckoff letter, Site symmetry	Coordinates	
	(1) x,y,z [u,v,w]	(2) \bar{x},\bar{y},z [\bar{u},\bar{v},w]
4 f 1	(3) \bar{x},\bar{y},\bar{z} [\bar{u},\bar{v},\bar{w}]	(4) x,y,\bar{z} [u,v, \bar{w}]
2 e m'	$x,y,1/2$ [u,v,0]	$\bar{x},\bar{y},1/2$ [$\bar{u},\bar{v},0$]
2 d m'	$x,y,0$ [u,v,0]	$\bar{x},\bar{y},0$ [$\bar{u},\bar{v},0$]
2 c 2	$0,0,z$ [0,0,w]	$0,0,\bar{z}$ [0,0, \bar{w}]
1 b $2/m'$	$0,0,1/2$ [0,0,0]	
1 a $2/m'$	$0,0,0$ [0,0,0]	

Symmetry of special projections

Along [001] 211	Along [100] $p2m'm'$ $a^* = c$	Along [010] $p2m'm'$ $a^* = c$
Origin at 0,0,z	Origin at x,0,0	Origin at 0,y,0

$p112'/m'$

No. 11.4.47

$2'/m'$

$p112'/m'$

Monoclinic/Rectangular

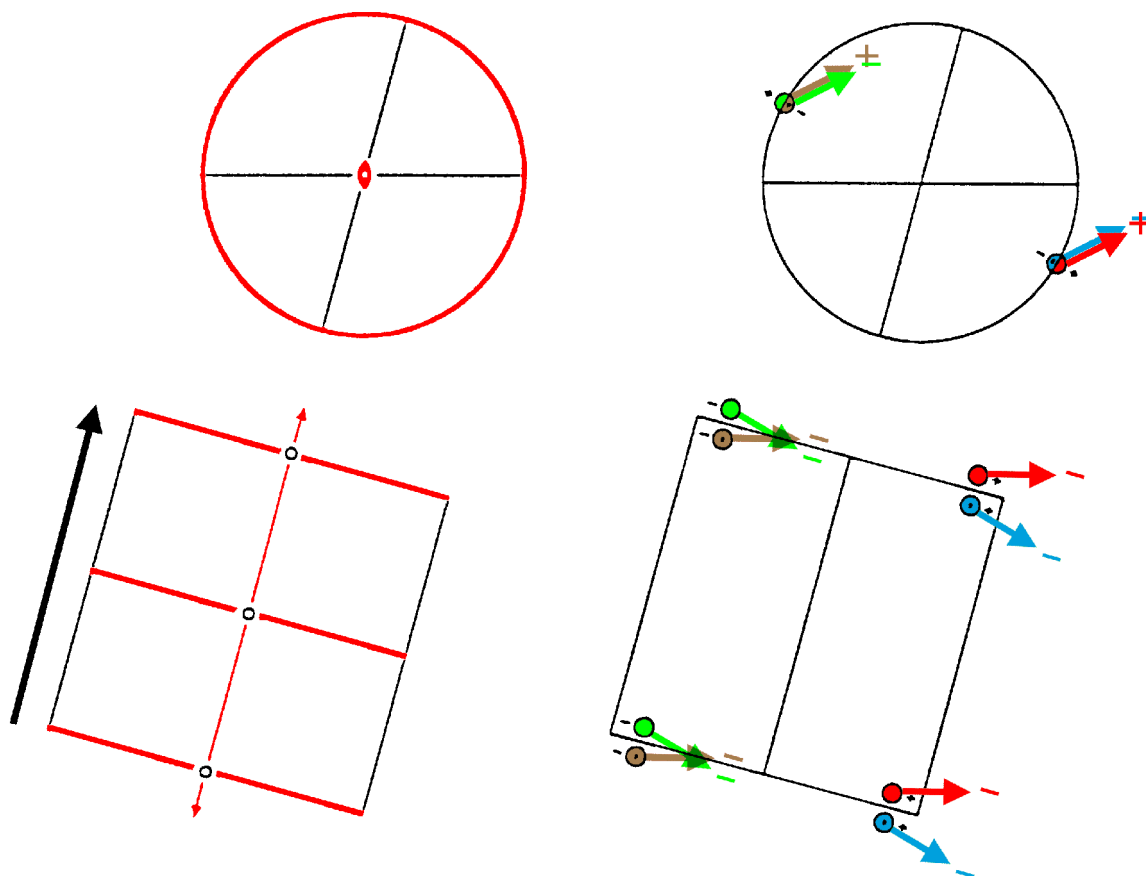

Origin at center $2'/m'$

Asymmetric unit $0 \leq y; 0 \leq z \leq 1/2$

Symmetry operations

- | | | | |
|-------------|------------------|-----------------------|------------------|
| (1) 1 | (2) $2' \ 0,0,z$ | (3) $\bar{1} \ 0,0,0$ | (4) $m' \ x,y,0$ |
| $(1 0,0,0)$ | $(2_z 0,0,0)'$ | $(\bar{1} 0,0,0)$ | $(m_z 0,0,0)'$ |

Generators selected (1); $t(0,0,1)$; (2); (3)

Positions

Multiplicity, Wyckoff letter, Site symmetry	Coordinates	
	(1) x,y,z [u,v,w]	(2) \bar{x},\bar{y},z [u,v, \bar{w}]
4 f 1	(3) \bar{x},\bar{y},\bar{z} [u,v,w]	(4) x,y,\bar{z} [u,v, \bar{w}]
2 e m'	$x,y,1/2$ [u,v,0]	$\bar{x},\bar{y},1/2$ [u,v,0]
2 d m'	$x,y,0$ [u,v,0]	$\bar{x},\bar{y},0$ [u,v,0]
2 c $2'$	$0,0,z$ [u,v,0]	$0,0,\bar{z}$ [u,v,0]
1 b $2'/m'$	$0,0,1/2$ [u,v,0]	
1 a $2'/m'$	$0,0,0$ [u,v,0]	

Symmetry of special projections

Along [001] $2'11$	Along [100] $p2'm'm$	Along [010] $p2'm'm$
Origin at 0,0,z	$a^* = c$ Origin at x,0,0	$a^* = c$ Origin at 0,y,0

$p112'/m$

$2'/m$

Monoclinic/Rectangular

No. 11.5.48

$p112'/m$

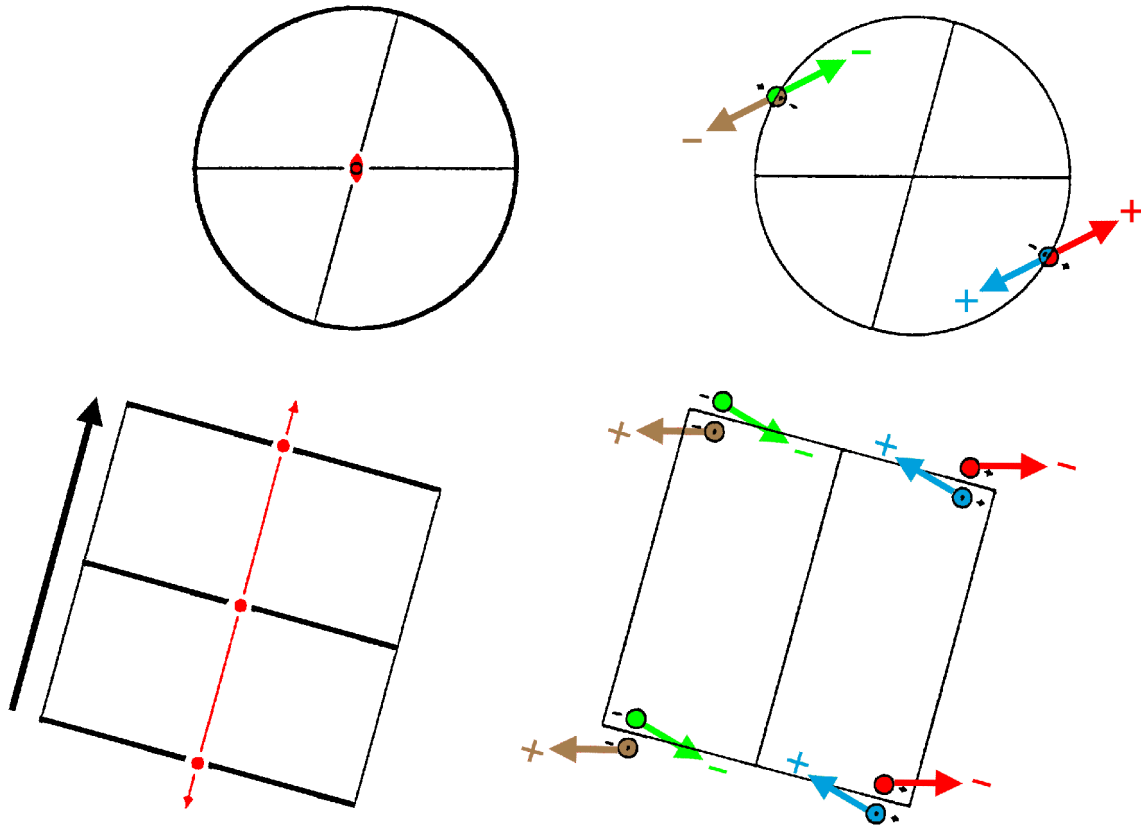

Origin at center $2'/m$

Asymmetric unit $0 \leq y; 0 \leq z \leq 1/2$

Symmetry operations

- | | | | |
|-------------|----------------------|----------------------------|---------------------|
| (1) 1 | (2) $2' \quad 0,0,z$ | (3) $\bar{1}' \quad 0,0,0$ | (4) $m \quad x,y,0$ |
| $(1 0,0,0)$ | $(2_z 0,0,0)'$ | $(\bar{1} 0,0,0)'$ | $(m_z 0,0,0)$ |

Generators selected (1); $t(0,0,1)$; (2); (3)

Positions

Multiplicity, Wyckoff letter, Site symmetry	Coordinates	
	(1) x,y,z [u,v,w]	(2) \bar{x},\bar{y},z [u,v,\bar{w}]
4 f 1	(3) \bar{x},\bar{y},\bar{z} [\bar{u},\bar{v},\bar{w}]	(4) x,y,\bar{z} [\bar{u},\bar{v},w]
2 e m	$x,y,1/2$ [$0,0,w$]	$\bar{x},\bar{y},1/2$ [$0,0,\bar{w}$]
2 d m	$x,y,0$ [$0,0,w$]	$\bar{x},\bar{y},0$ [$0,0,\bar{w}$]
2 c 2'	$0,0,z$ [$u,v,0$]	$0,0,\bar{z}$ [$\bar{u},\bar{v},0$]
1 b 2'/m	$0,0,1/2$ [$0,0,0$]	
1 a 2'/m	$0,0,0$ [$0,0,0$]	

Symmetry of special projections

Along [001] 2111'	Along [100] $p2mm$ $a^* = c$	Along [010] $p2mm$ $a^* = c$
Origin at $0,0,z$	Origin at $x,0,0$	Origin at $0,y,0$

$p_{2c}112'/m'$

$2/m1'$

Monoclinic/Rectangular

No. 11.6.49

$p_{2c}112'/m'$

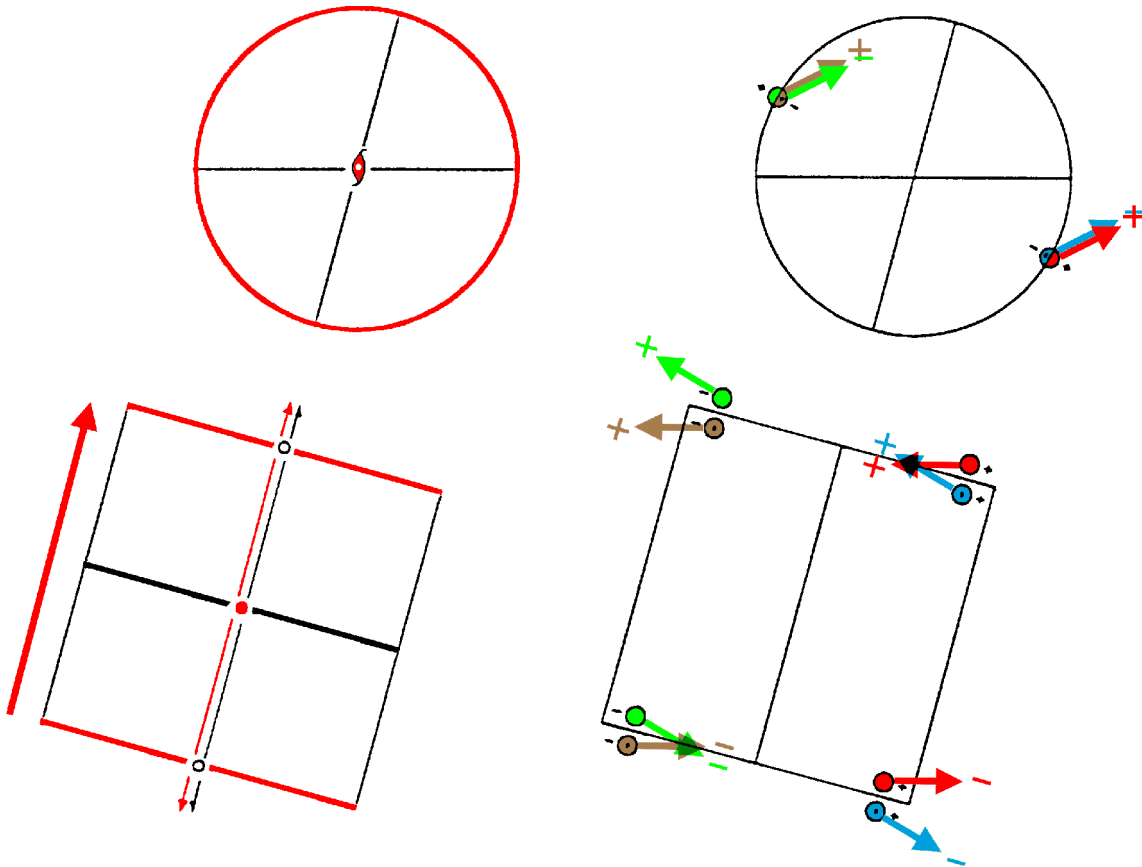

Origin at center $2'/m'$

Asymmetric unit $0 \leq y; 0 \leq z \leq 1/2$

Symmetry operations

For $(0,0,0)$ + set

(1) 1	(2) $2' \ 0,0,z$	(3) $\bar{1} \ 0,0,0$	(4) $m' \ x,y,0$
$(1 0,0,0)$	$(2_z 0,0,0)'$	$(\bar{1} 0,0,0)$	$(m_z 0,0,0)'$

For $(0,0,1)'$ + set

(1) $t' \ (0,0,1)$	(2) $2 \ (0,0,1) \ 0,0,z$	(3) $\bar{1}' \ 0,0,1/2$	(4) $m \ x,y,1/2$
$(1 0,0,1)'$	$(2_z 0,0,1)$	$(\bar{1}' 0,0,1)'$	$(m_z 0,0,1)$

Generators selected (1); $t(0,0,1)'$; (2); (3)

Positions

Multiplicity, Wyckoff letter, Site symmetry	Coordinates	
		$(0,0,0)+$ $(0,0,1)'+$
4 f 1	(1) $x,y,z [u,v,w]$	(2) $\bar{x},\bar{y},z [u,v,\bar{w}]$
	(3) $\bar{x},\bar{y},\bar{z} [u,v,w]$	(4) $x,y,\bar{z} [u,v,\bar{w}]$
2 e m	$x,y,1/2 [0,0,w]$	$\bar{x},\bar{y},1/2 [0,0,\bar{w}]$
2 d m'	$x,y,0 [u,v,0]$	$\bar{x},\bar{y},0 [u,v,0]$
2 c 2'	$0,0,z [u,v,0]$	$0,0,\bar{z} [u,v,0]$
1 b 2'/m	$0,0,1/2 [0,0,0]$	
1 a 2'/m'	$0,0,0 [u,v,0]$	

Symmetry of special projections

Along [001] $2111'$	Along [100] $p_{2a^*}2mm$	Along [010] $p_{2a^*}2mm$
Origin at $0,0,z$	$a^* = c$ Origin at $x,0,1/4$	$a^* = c$ Origin at $0,y,1/4$

$p_{2c}112/m$

$2/m1'$

Monoclinic/Rectangular

No. 11.7.50

$p_{2c}112/m$

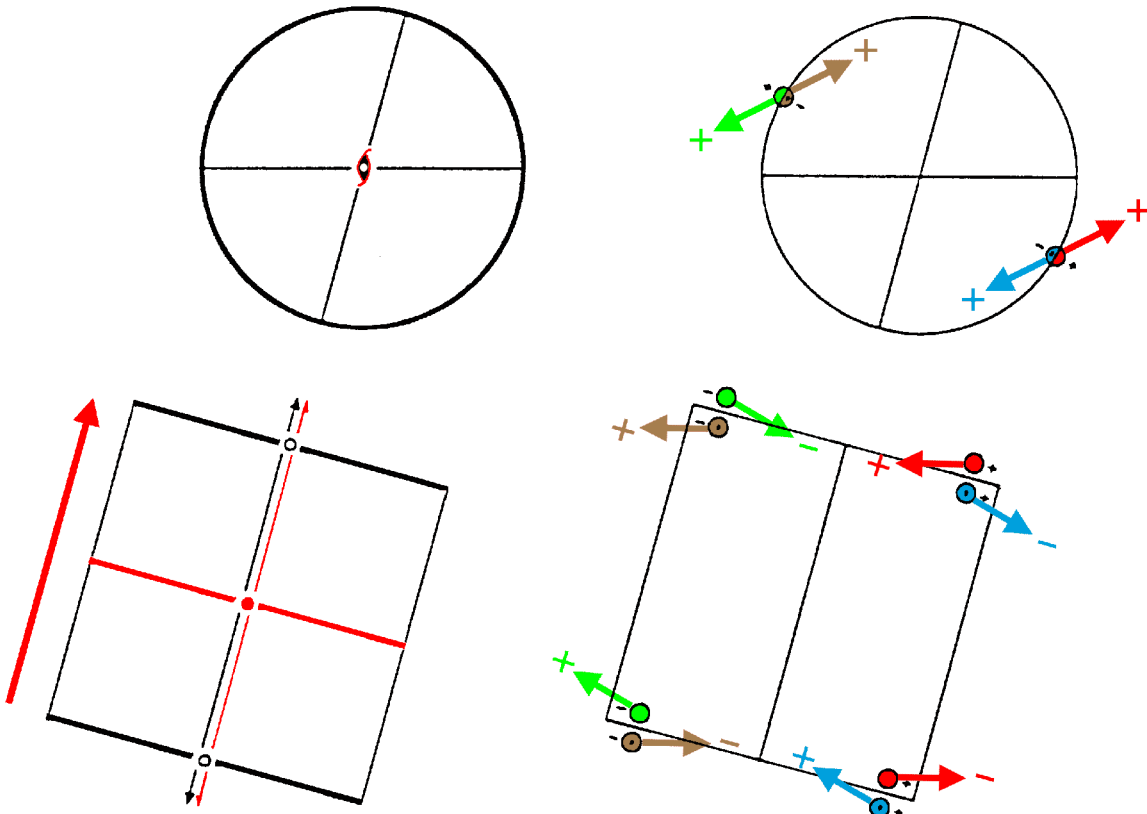

Origin at center $2/m$

Asymmetric unit $0 \leq y$; $0 \leq z \leq 1/2$

Symmetry operations

For $(0,0,0)$ + set

(1) 1	(2) $2_{0,0,z}$	(3) $\bar{1}_{0,0,0}$	(4) $m_{x,y,0}$
$(1 0,0,0)$	$(2_z 0,0,0)$	$(\bar{1} 0,0,0)$	$(m_z 0,0,0)$

For $(0,0,1)'$ + set

(1) $t'(0,0,1)$	(2) $2'(0,0,1)$	$0,0,z$	(3) $\bar{1}'_{0,0,1/2}$	(4) $m'_{x,y,1/2}$
$(1 0,0,1)'$	$(2'_z 0,0,1)'$		$(\bar{1}' 0,0,1)'$	$(m'_z 0,0,1)'$

Generators selected (1); $t(0,0,1)'$; (2); (3)

Positions

Multiplicity, Wyckoff letter, Site symmetry	Coordinates	
		$(0,0,0)+$ $(0,0,1)'+$
4 f 1	(1) x,y,z [u,v,w]	(2) \bar{x},\bar{y},z [\bar{u},\bar{v},w]
	(3) \bar{x},\bar{y},\bar{z} [u,v,w]	(4) x,y,\bar{z} [\bar{u},\bar{v},w]
2 e m'	$x,y,1/2$ [u,v,0]	$\bar{x},\bar{y},1/2$ [$\bar{u},\bar{v},0$]
2 d m	$x,y,0$ [0,0,w]	$\bar{x},\bar{y},0$ [0,0,w]
2 c 2	$0,0,z$ [0,0,w]	$0,0,\bar{z}$ [0,0,w]
1 b $2/m'$	$0,0,1/2$ [0,0,0]	
1 a $2/m$	$0,0,0$ [0,0,w]	

Symmetry of special projections

Along [001] $2111'$	Along [100] $p_{2a^*}2m'm'$	Along [010] $p_{2a^*}2m'm'$
Origin at 0,0,z	$a^* = c$ Origin at $x,0,1/4$	$a^* = c$ Origin at $0,y,1/4$

$p112_1/m$

$2/m$

Monoclinic/Rectangular

No. 12.1.51

$p112_1/m$

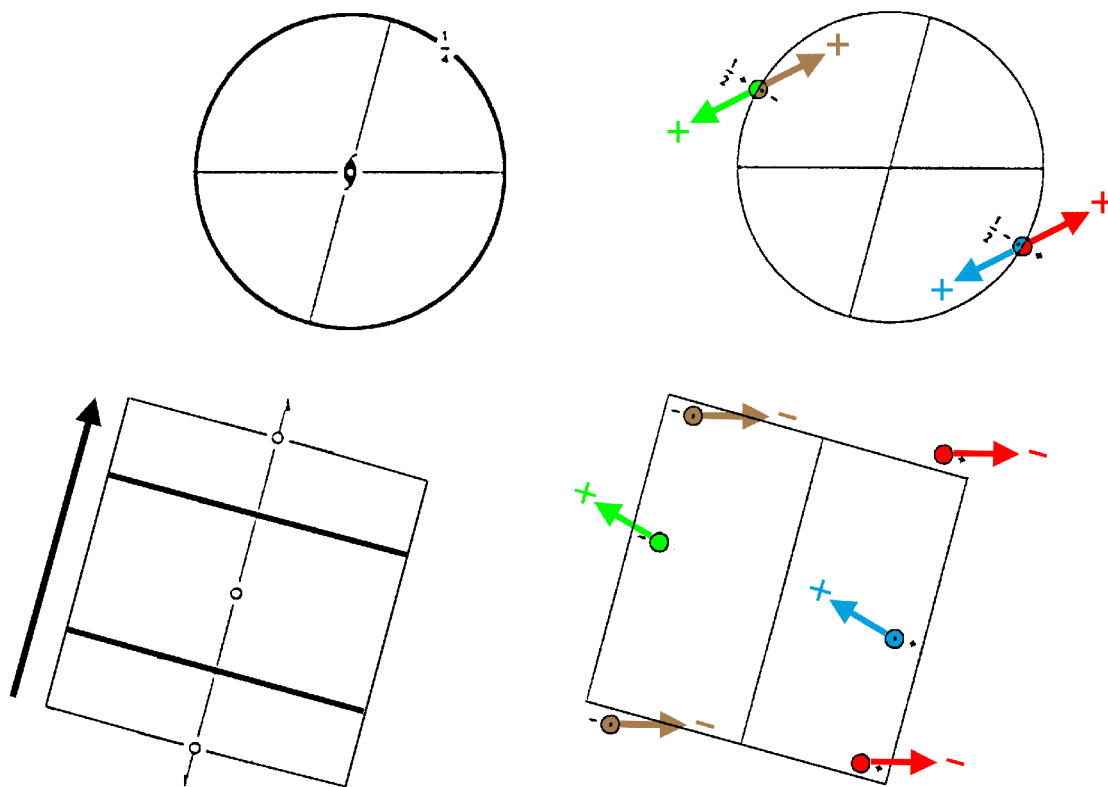

Origin at $\bar{1}$ on 2_1

Asymmetric unit $0 \leq z \leq 1/4$

Symmetry operations

- | | | | |
|--------------------|---|--|--|
| (1) 1
(1 0,0,0) | (2) $2(0,0,1/2)$ $0,0,z$
(2_z 0,0, $1/2$) | (3) $\bar{1}$ 0,0,0
($\bar{1}$ 0,0,0) | (4) m $x,y,1/4$
(m_z 0,0, $1/2$) |
|--------------------|---|--|--|

Generators selected (1); $t(0,0,1)$; (2); (3)

Positions

	Coordinates	
Multiplicity, Wyckoff letter, Site symmetry		
4 c 1	(1) $x,y,z [u,v,w]$	(2) $\bar{x},\bar{y},z+1/2 [\bar{u},\bar{v},w]$ (3) $\bar{x},\bar{y},\bar{z} [u,v,w]$ (4) $x,y,\bar{z}+1/2 [\bar{u},\bar{v},w]$
2 b m	$x,y,1/4 [0,0,w]$	$\bar{x},\bar{y},3/4 [0,0,w]$
2 a $\bar{1}$	$0,0,0 [u,v,w]$	$0,0,1/2 [\bar{u},\bar{v},w]$

Symmetry of special projections

Along [001] $2111'$	Along [100] $p2'mg'$	Along [010] $p2'mg'$
Origin at $0,0,z$	$a^* = c$ Origin at $x,0,0$	$a^* = c$ Origin at $0,y,0$

$p112_1/m1'$

$2/m1'$

Monoclinic/Rectangular

No. 12.2.52

$p112_1/m1'$

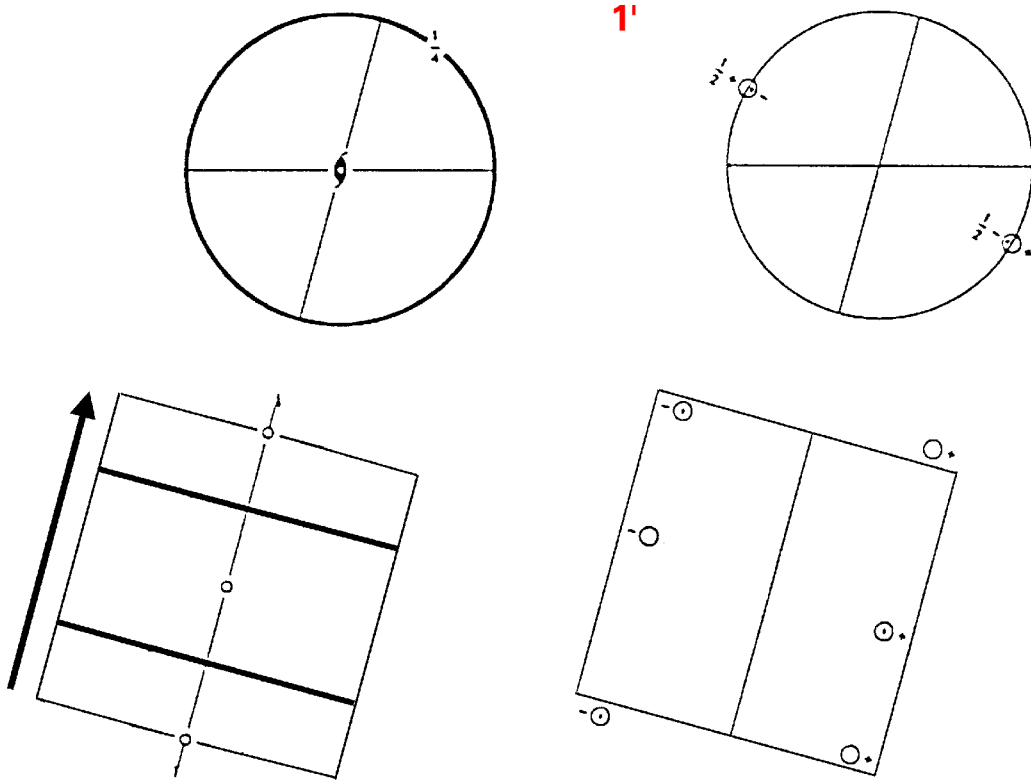

Origin at $\bar{1}1'$ on $2_11'$

Asymmetric unit $0 \leq z \leq 1/4$

Symmetry operations

For $1 + \text{set}$

(1) 1	(2) $2(0,0,1/2)$	$0,0,z$	(3) $\bar{1}$	$0,0,0$	(4) m	$x,y,1/4$
$(1 0,0,0)$	$(2_z 0,0,1/2)$		$(\bar{1} 0,0,0)$		$(m_z 0,0,1/2)$	

For $1' + \text{set}$

(1) $1'$	(2) $2(0,0,1/2)'$	$0,0,z$	(3) $\bar{1}'$	$0,0,0$	(4) m'	$x,y,1/4$
$(1 0,0,0)'$	$(2_z 0,0,1/2)'$		$(\bar{1}' 0,0,0)'$		$(m_z 0,0,1/2)'$	

Continued

No. 12.2.52

$p112_1/m1'$

Generators selected (1); $t(0,0,1)$; (2); (3); $1'$

Positions

		Coordinates			
Multiplicity, Wyckoff letter, Site symmetry			$1+$	$1'+$	
4	c $11'$	(1) x,y,z [0,0,0]	(2) $\bar{x},\bar{y},z+1/2$ [0,0,0]	(3) \bar{x},\bar{y},\bar{z} [0,0,0]	(4) $x,y,\bar{z}+1/2$ [0,0,0]
2	b $m1'$	$x,y,1/4$ [0,0,0]		$\bar{x},\bar{y},3/4$ [0,0,0]	
2	a $\bar{1}1'$	$0,0,0$ [0,0,0]		$0,0,1/2$ [0,0,0]	

Symmetry of special projections

Along [001] $2111'$	Along [100] $p2mg1'$	Along [010] $p2mg1'$
Origin at $0,0,z$	$a^* = c$ Origin at $x,0,0$	$a^* = c$ Origin at $0,y,0$

$p112_1/m'$

$2/m'$

Monoclinic/Rectangular

No. 12.3.53

$p112_1/m'$

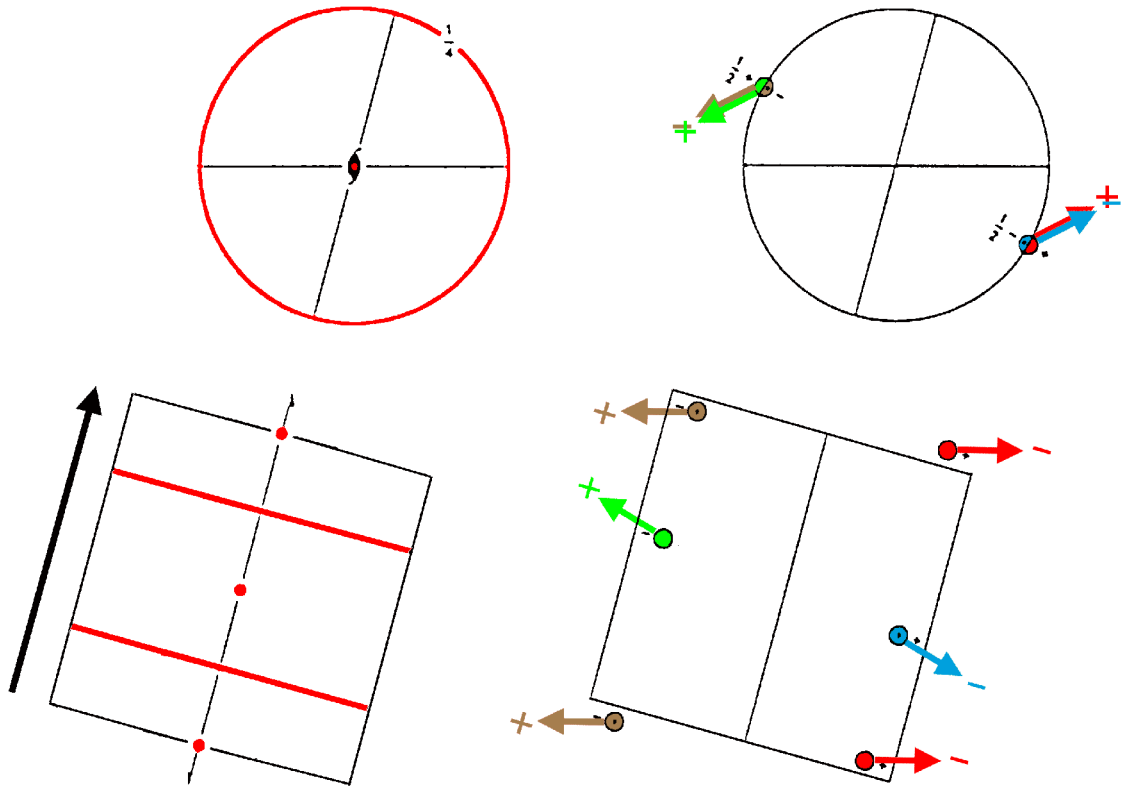

Origin at $\bar{1}$ on 2_1

Asymmetric unit $0 \leq z \leq 1/4$

Symmetry operations

(1) 1
(1|0,0,0)

(2) $2(0,0,1/2)$ $0,0,z$
(2_z | $0,0,1/2$)

(3) $\bar{1}$ $0,0,0$
($\bar{1}$ | $0,0,0$)'

(4) m' $x,y,1/4$
(m_z | $0,0,1/2$)'

Continued

No. 12.3.53

$p112_1/m'$

Generators selected (1); $t(0,0,1)$; (2); (3)

Positions

	Coordinates			
Multiplicity, Wyckoff letter, Site symmetry				
4 c 1	(1) x,y,z [u,v,w]	(2) $\bar{x},\bar{y},z+1/2$ [\bar{u},\bar{v},w]	(3) \bar{x},\bar{y},\bar{z} [\bar{u},\bar{v},\bar{w}]	(4) $x,y,\bar{z}+1/2$ [u,v, \bar{w}]
2 b m'	$x,y,1/4$ [u,v,0]	$\bar{x},\bar{y},3/4$ [$\bar{u},\bar{v},0$]		
2 a $\bar{1}'$	$0,0,0$ [0,0,0]	$0,0,1/2$ [0,0,0]		

Symmetry of special projections

Along [001] 211	Along [100] $p2m'g'$	Along [010] $p2m'g'$
Origin at 0,0,z	$a^* = c$ Origin at x,0,0	$a^* = c$ Origin at 0,y,0

$p112_1/m'$

$2'/m'$

Monoclinic/Rectangular

No. 12.4.54

$p112_1/m'$

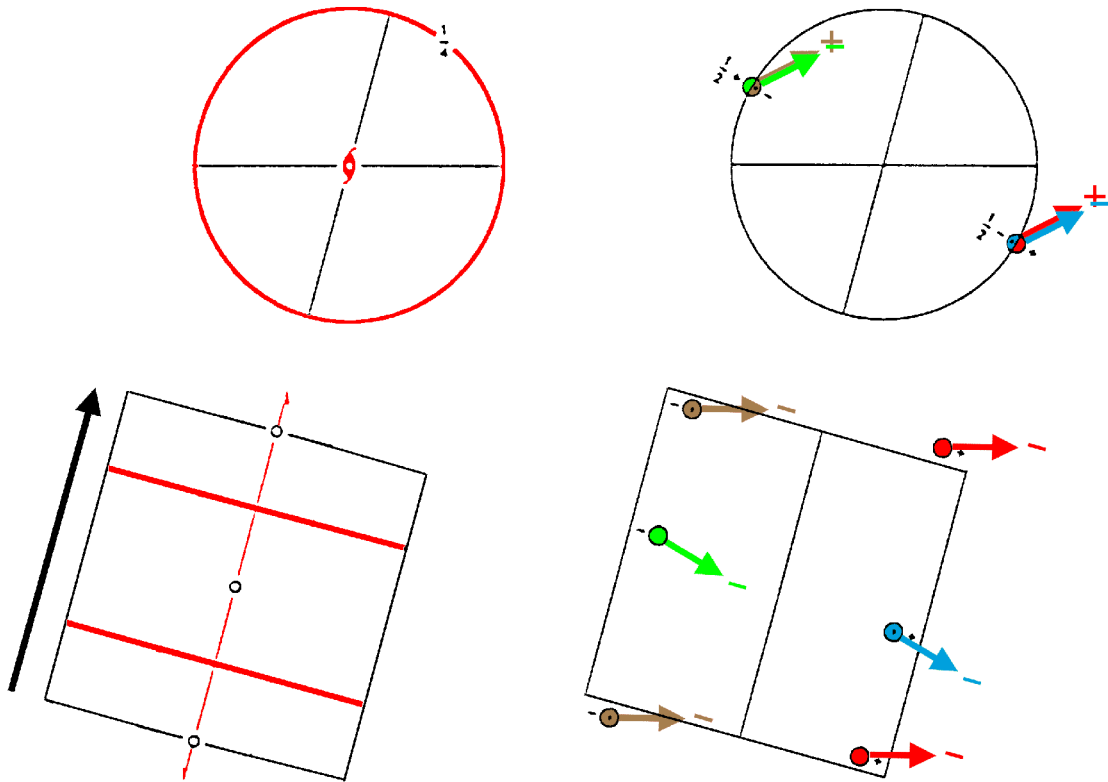

Origin at $\bar{1}$ on $2_1'$

Asymmetric unit $0 \leq z \leq 1/4$

Symmetry operations

(1) 1
(1|0,0,0)

(2) $2'(0,0,1/2)$ $0,0,z$
(2_z |0,0, $1/2$)'

(3) $\bar{1}$ 0,0,0
($\bar{1}$ |0,0,0)

(4) m' x,y,1/4
(m_z |0,0, $1/2$)'

Continued

No. 12.4.54

$p112_1/m'$

Generators selected (1); $t(0,0,1)$; (2); (3)

Positions

	Coordinates			
Multiplicity, Wyckoff letter, Site symmetry				
4 c 1	(1) x,y,z [u,v,w]	(2) $\bar{x},\bar{y},z+1/2$ [u,v, \bar{w}]	(3) \bar{x},\bar{y},\bar{z} [u,v,w]	(4) $x,y,\bar{z}+1/2$ [u,v, \bar{w}]
2 b m'	$x,y,1/4$ [u,v,0]	$\bar{x},\bar{y},3/4$ [u,v,0]		
2 a $\bar{1}$	$0,0,0$ [u,v,w]	$0,0,1/2$ [u,v, \bar{w}]		

Symmetry of special projections

Along [001] $2'11$	Along [100] $p2'm'g$	Along [010] $p2'm'g$
	$a^* = c$	$a^* = c$
Origin at $0,0,z$	Origin at $x,0,0$	Origin at $0,y,0$

$p112_1/m$

$2'/m$

Monoclinic/Rectangular

No. 12.5.55

$p112_1/m$

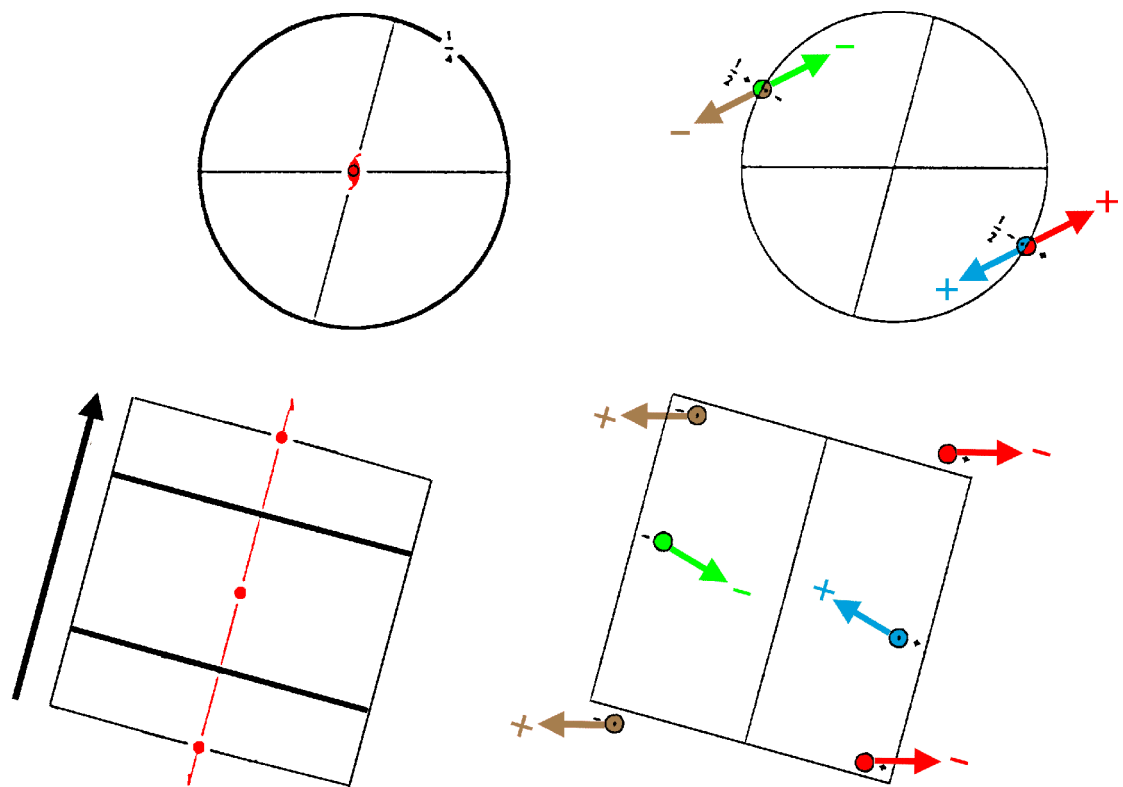

Origin at $\bar{1}$ on $2_1'$

Asymmetric unit $0 \leq z \leq 1/4$

Symmetry operations

- | | | | |
|--------------------|---|---|--|
| (1) 1
(1 0,0,0) | (2) $2'(0,0,1/2)$ $0,0,z$
(2_z 0,0, $1/2$)' | (3) $\bar{1}$ 0,0,0
($\bar{1}$ 0,0,0)' | (4) m $x,y,1/4$
(m_z 0,0, $1/2$) |
|--------------------|---|---|--|

Continued

No. 12.5.55

$p112_1/m$

Generators selected (1); $t(0,0,1)$; (2); (3)

Positions

	Coordinates			
Multiplicity, Wyckoff letter, Site symmetry				
4 c 1	(1) x,y,z [u,v,w]	(2) $\bar{x},\bar{y},z+1/2$ [u,v, \bar{w}]	(3) \bar{x},\bar{y},\bar{z} [\bar{u},\bar{v},\bar{w}]	(4) $x,y,\bar{z}+1/2$ [\bar{u},\bar{v},w]
2 b m	$x,y,1/4$ [0,0,w]	$\bar{x},\bar{y},3/4$ [0,0, \bar{w}]		
2 a $\bar{1}$ '	0,0,0 [0,0,0]	0,0,1/2 [0,0,0]		

Symmetry of special projections

Along [001] $2111'$	Along [100] $p2mg$	Along [010] $p2mg$
	$a^* = c$	$a^* = c$
Origin at 0,0,z	Origin at x,0,0	Origin at 0,y,0

*p*222

222

Orthorhombic

No. 13.1.56

*p*222

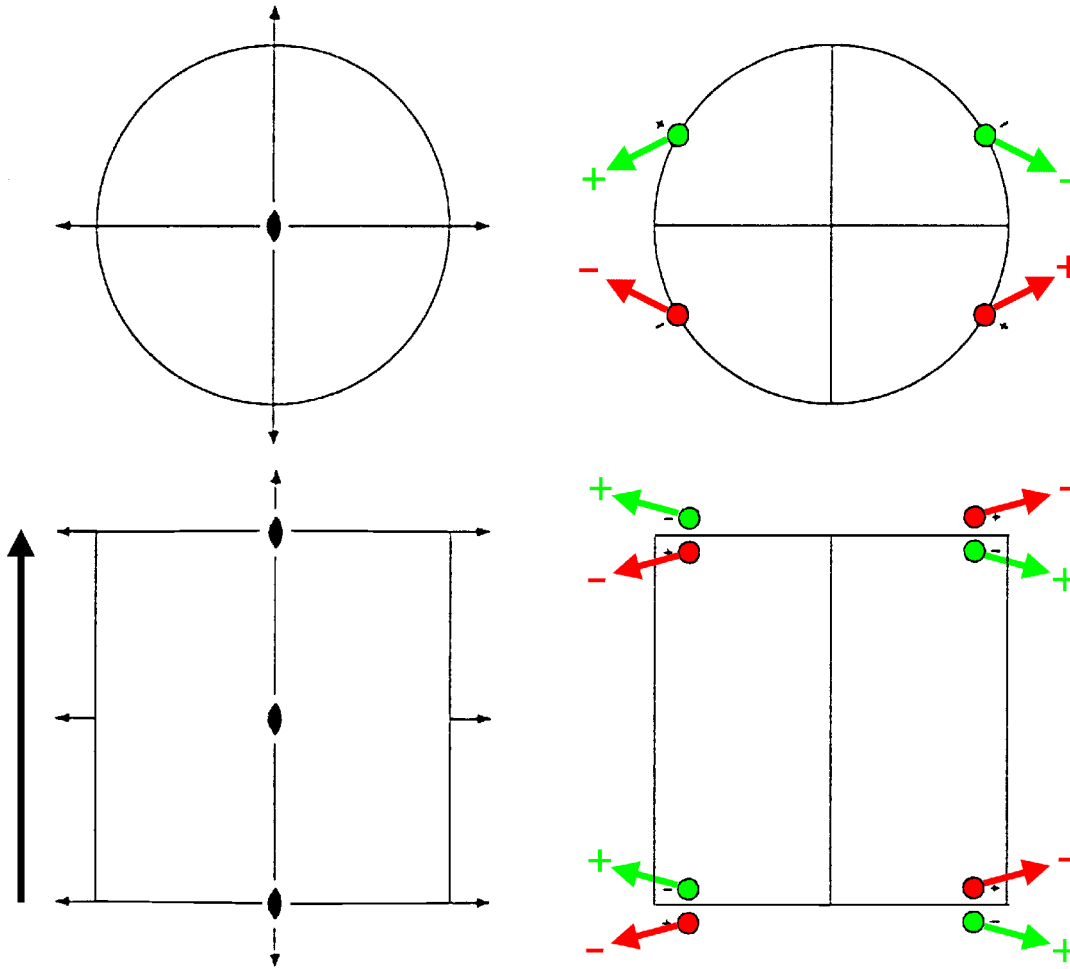

Origin at 222

Asymmetric unit $0 \leq x; 0 \leq y; 0 \leq z \leq 1$

Symmetry operations

- | | | | |
|---------------|-----------------------------|-----------------------------|-----------------------------|
| (1) 1 | (2) 2 $0,0,z$ | (3) 2 $0,y,0$ | (4) 2 $x,0,0$ |
| (1 $0,0,0$) | (2 _z $0,0,0$) | (2 _y $0,0,0$) | (2 _x $0,0,0$) |

Generators selected (1); $t(0,0,1)$; (2); (3)

Positions

Multiplicity, Wyckoff letter, Site symmetry	Coordinates	
	(1) x, y, z [u, v, w]	(2) \bar{x}, \bar{y}, z [\bar{u}, \bar{v}, w]
4 h 1	(3) \bar{x}, y, \bar{z} [\bar{u}, v, \bar{w}]	(4) x, \bar{y}, \bar{z} [u, \bar{v}, \bar{w}]
2 g ..2	0,0,z [0,0,w]	0,0, \bar{z} [0,0, \bar{w}]
2 f .2.	0,y,1/2 [0,v,0]	0, \bar{y} ,1/2 [0, \bar{v} ,0]
2 e .2.	0,y,0 [0,v,0]	0, \bar{y} ,0 [0, \bar{v} ,0]
2 d 2..	x,0,1/2 [u,0,0]	\bar{x} ,0,1/2 [\bar{u} ,0,0]
2 c 2..	x,0,0 [u,0,0]	\bar{x} ,0,0 [\bar{u} ,0,0]
1 b 222	0,0,1/2 [0,0,0]	
1 a 222	0,0,0 [0,0,0]	

Symmetry of special projections

Along [001] $2m'm'$	Along [100] $p2m'm'$	Along [010] $p2m'm'$
Origin at 0,0,z	$\mathbf{a}^* = \mathbf{c}$ Origin at x,0,0	$\mathbf{a}^* = \mathbf{c}$ Origin at 0,y,0

$p2221'$

No. 13.2.57

$2221'$

$p2221'$

Orthorhombic

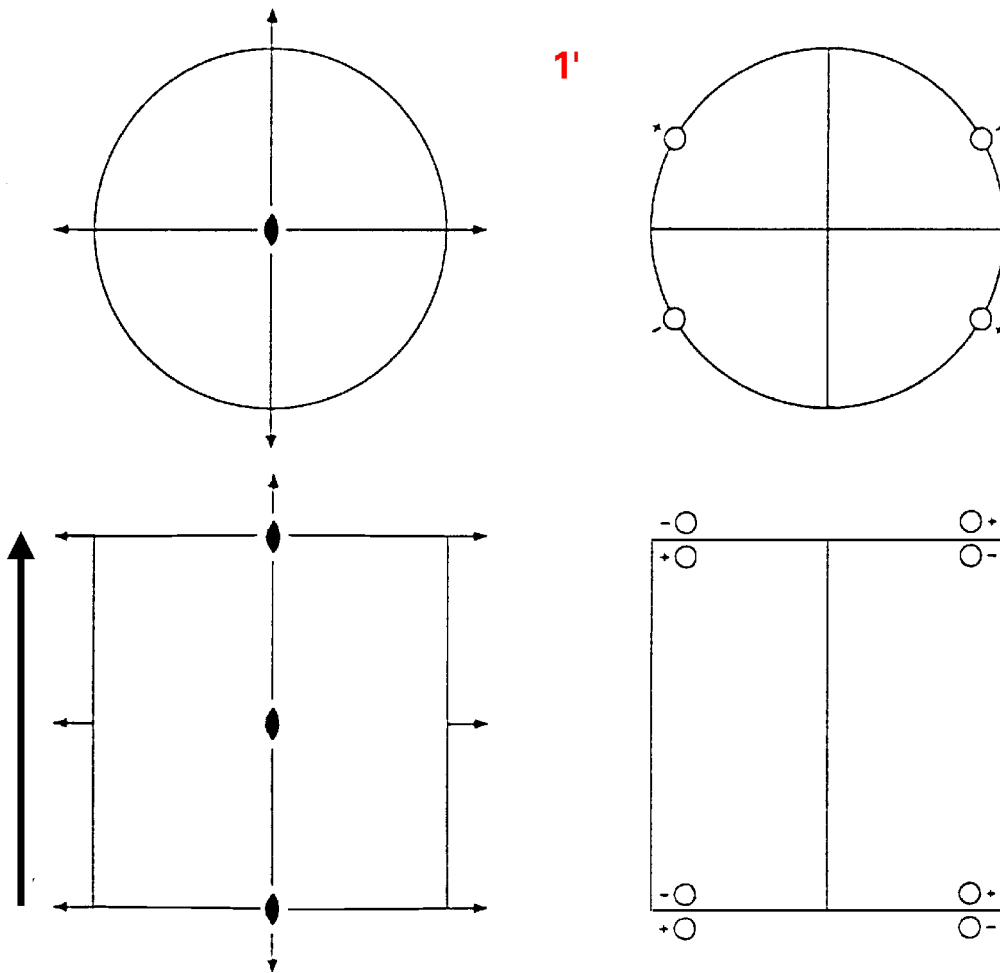

Origin at $2221'$

Asymmetric unit $0 \leq x; 0 \leq y; 0 \leq z \leq 1$

Symmetry operations

For 1 + set

(1) 1	(2) 2 $0,0,z$	(3) 2 $0,y,0$	(4) 2 $x,0,0$
(1 $0,0,0$)	(2 _z $0,0,0$)	(2 _y $0,0,0$)	(2 _x $0,0,0$)

For 1' + set

(1) 1'	(2) 2' $0,0,z$	(3) 2' $0,y,0$	(4) 2' $x,0,0$
(1 $0,0,0$)'	(2 _z $0,0,0$)'	(2 _y $0,0,0$)'	(2 _x $0,0,0$)'

Generators selected (1); $t(0,0,1)$; (2); (3); $1'$

Positions

Multiplicity, Wyckoff letter, Site symmetry	Coordinates	
	$1+$	$1' +$
4 h $11'$	(1) $x,y,z [0,0,0]$	(2) $\bar{x},\bar{y},z [0,0,0]$
	(3) $\bar{x},y,\bar{z} [0,0,0]$	(4) $x,\bar{y},\bar{z} [0,0,0]$
2 g $..21'$	$0,0,z [0,0,0]$	$0,0,\bar{z} [0,0,0]$
2 f $.2.1'$	$0,y,1/2 [0,0,0]$	$0,\bar{y},1/2 [0,0,0]$
2 e $.2.1'$	$0,y,0 [0,0,0]$	$0,\bar{y},0 [0,0,0]$
2 d $2..1'$	$x,0,1/2 [0,0,0]$	$\bar{x},0,1/2 [0,0,0]$
2 c $2..1'$	$x,0,0 [0,0,0]$	$\bar{x},0,0 [0,0,0]$
1 b $2221'$	$0,0,1/2 [0,0,0]$	
1 a $2221'$	$0,0,0 [0,0,0]$	

Symmetry of special projections

Along [001] $2mm1'$	Along [100] $p2mm1'$	Along [010] $p2mm1'$
Origin at $0,0,z$	$\mathbf{a}^* = \mathbf{c}$ Origin at $x,0,0$	$\mathbf{a}^* = \mathbf{c}$ Origin at $0,y,0$

$p22'2'$

No. 13.3.58

$22'2'$

$p22'2'$

Orthorhombic

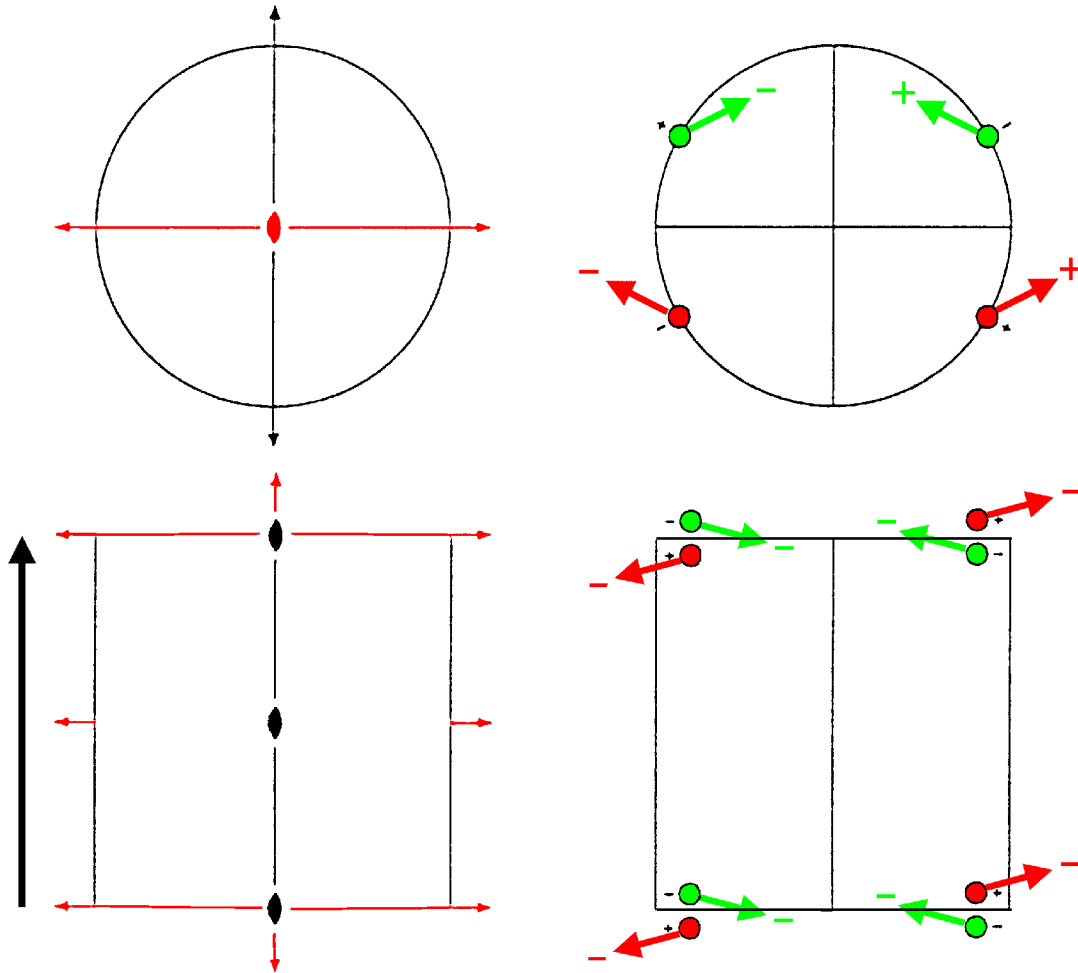

Origin at $22'2'$

Asymmetric unit $0 \leq x; 0 \leq y; 0 \leq z \leq 1$

Symmetry operations

- | | | | |
|--------------------|--------------------------------------|--------------------------------------|-------------------------------------|
| (1) 1
(1 0,0,0) | (2) $2'_z$ 0,0,z
(2_z 0,0,0)' | (3) $2'_y$ 0,y,0
(2_y 0,0,0)' | (4) $2'_x$ x,0,0
(2_x 0,0,0) |
|--------------------|--------------------------------------|--------------------------------------|-------------------------------------|

Generators selected (1); t(0,0,1); (2); (3)

Positions

Multiplicity, Wyckoff letter, Site symmetry	Coordinates	
	(1) x, y, z [u,v,w]	(2) \bar{x}, \bar{y}, z [u,v, \bar{w}]
4 h 1	(3) \bar{x}, y, \bar{z} [u, \bar{v} ,w]	(4) x, \bar{y}, \bar{z} [u, \bar{v} , \bar{w}]
2 g ..2'	0,0,z [u,v,0]	0,0, \bar{z} [u, \bar{v} ,0]
2 f .2'	0,y,1/2 [u,0,w]	0, \bar{y} ,1/2 [u,0, \bar{w}]
2 e .2'	0,y,0 [u,0,w]	0, \bar{y} ,0 [u,0, \bar{w}]
2 d 2..	x,0,1/2 [u,0,0]	\bar{x} ,0,1/2 [u,0,0]
2 c 2..	x,0,0 [u,0,0]	\bar{x} ,0,0 [u,0,0]
1 b 22'2'	0,0,1/2 [u,0,0]	
1 a 22'2'	0,0,0 [u,0,0]	

Symmetry of special projections

Along [001] 2'mm'	Along [100] p2mm	Along [010] p2'm'm
Origin at 0,0,z	$\mathbf{a}^* = \mathbf{c}$ Origin at x,0,0	$\mathbf{a}^* = \mathbf{c}$ Origin at 0,y,0

$p2'2'2$

No. 13.4.59

$2'2'2$

$p2'2'2$

Orthorhombic

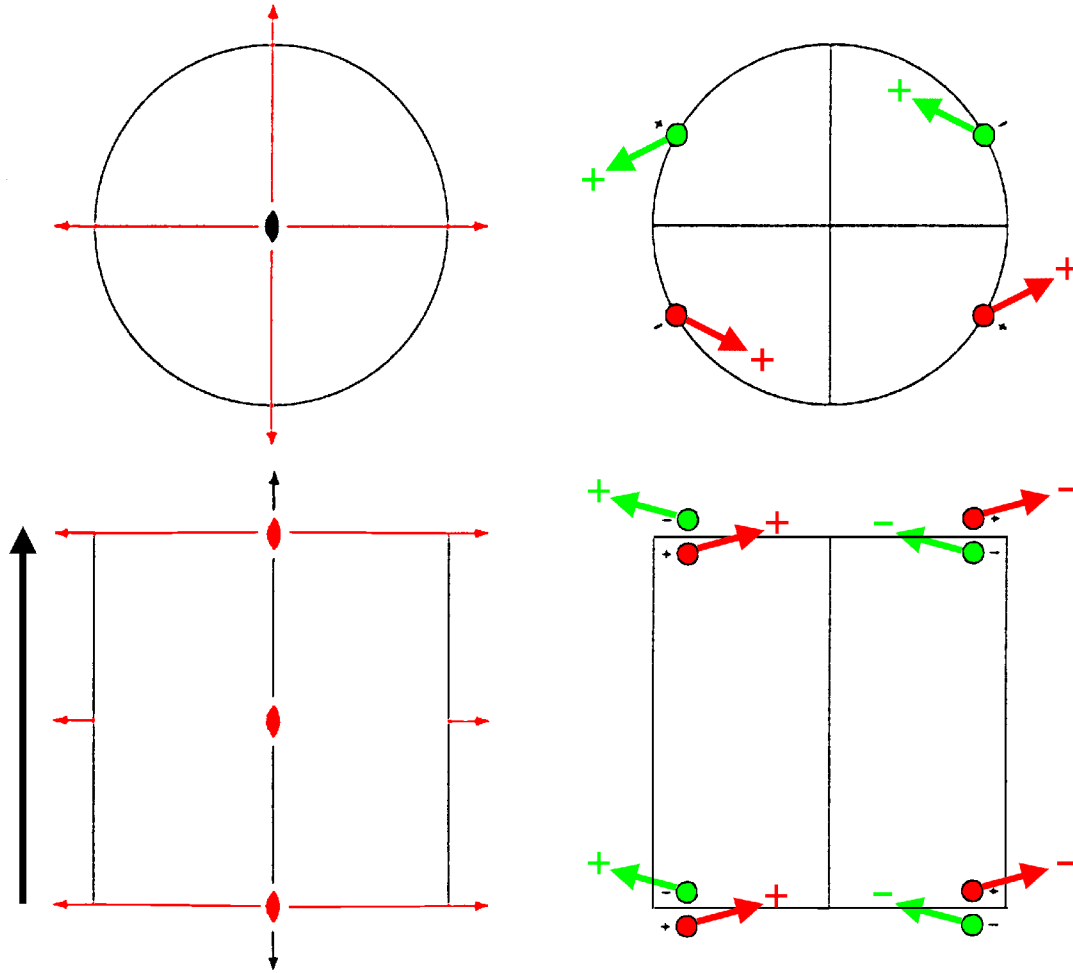

Origin at $2'2'2$

Asymmetric unit $0 \leq x; 0 \leq y; 0 \leq z \leq 1$

Symmetry operations

(1) 1
(1|0,0,0)

(2) $2_{0,0,z}$
(2_z |0,0,0)

(3) $2'_{0,y,0}$
(2_y |0,0,0)'

(4) $2'_x,0,0$
(2_x |0,0,0)'

Generators selected (1); $t(0,0,1)$; (2); (3)

Positions

Multiplicity, Wyckoff letter, Site symmetry	Coordinates	
	(1) x,y,z [u,v,w]	(2) \bar{x},\bar{y},z [\bar{u},\bar{v},w]
4 h 1	(3) \bar{x},y,\bar{z} [u,\bar{v},w]	(4) x,\bar{y},\bar{z} [\bar{u},v,w]
2 g ..2	0,0,z [0,0,w]	0,0, \bar{z} [0,0,w]
2 f .2'	0,y,1/2 [u,0,w]	0, \bar{y} ,1/2 [\bar{u} ,0,w]
2 e .2'	0,y,0 [u,0,w]	0, \bar{y} ,0 [\bar{u} ,0,w]
2 d 2'..	x,0,1/2 [0,v,w]	\bar{x} ,0,1/2 [0, \bar{v} ,w]
2 c 2'..	x,0,0 [0,v,w]	\bar{x} ,0,0 [0, \bar{v} ,w]
1 b 2'2'2	0,0,1/2 [0,0,w]	
1 a 2'2'2	0,0,0 [0,0,w]	

Symmetry of special projections

Along [001] 2mm	Along [100] $p2'mm'$ $\mathbf{a}^* = \mathbf{c}$	Along [010] $p2'mm'$ $\mathbf{a}^* = \mathbf{c}$
Origin at 0,0,z	Origin at x,0,0	Origin at 0,y,0

$p_{2c}22'2'$

2221'

Orthorhombic

No. 13.5.60

$p_{2c}22'2'$

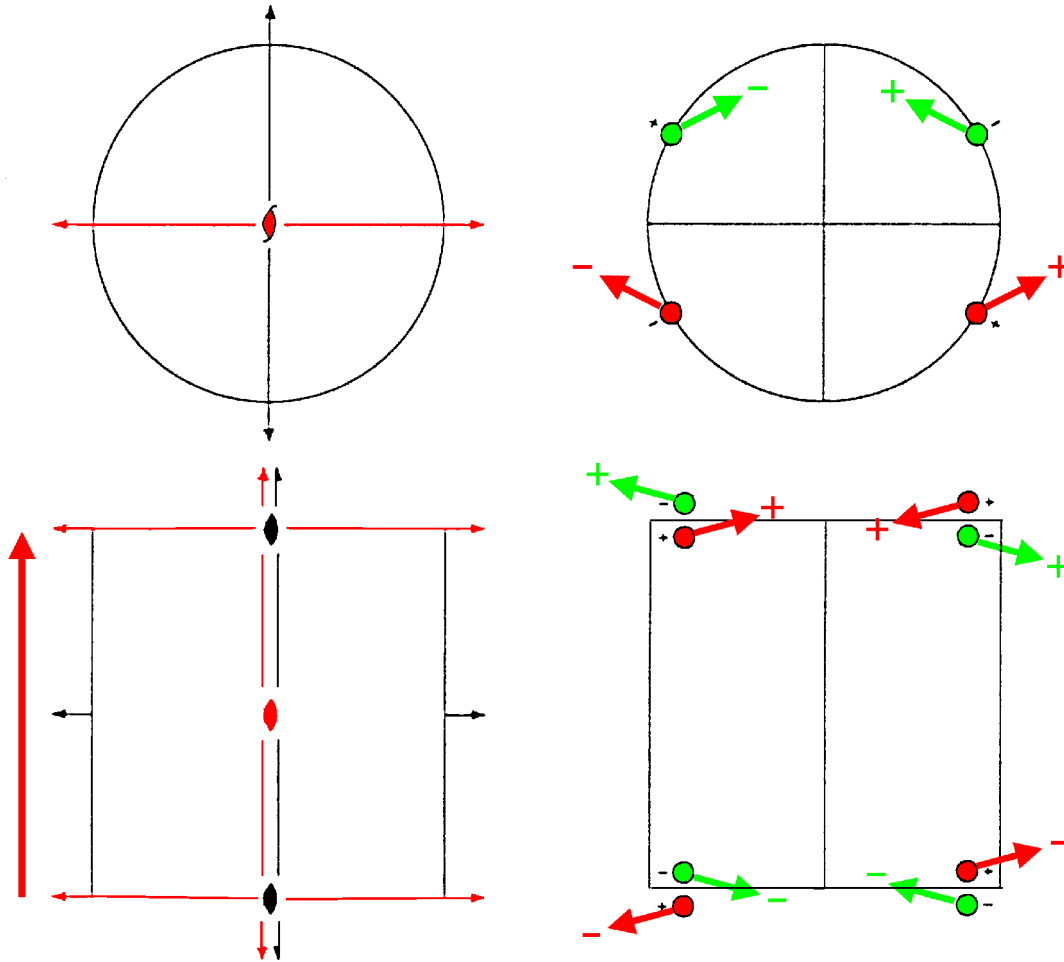

Origin at $22'2'$

Asymmetric unit $0 \leq x; 0 \leq y; 0 \leq z \leq 1$

Symmetry operations

For $(0,0,0)$ + set

(1) 1	(2) $2'_z \ 0,0,z$	(3) $2'_y \ 0,y,0$	(4) $2'_x \ x,0,0$
(1 $0,0,0$)	(2_z $0,0,0$)'	(2_y $0,0,0$)'	(2_x $0,0,0$)

For $(0,0,1)'$ + set

(1) $t' \ (0,0,1)$	(2) $2 \ (0,0,1) \ 0,0,z$	(3) $2 \ 0,y,1/2$	(4) $2'_x \ x,0,1/2$
(1 $0,0,1$)'	(2_z $0,0,1$)	(2_y $0,0,1$)	(2_x $0,0,1$)'

Generators selected (1); $t(0,0,1)'$; (2); (3)

Positions

Multiplicity, Wyckoff letter, Site symmetry	Coordinates	
		$(0,0,0)_+$ $(0,0,1)'$ +
4 h 1	(1) $x,y,z [u,v,w]$	(2) $\bar{x},\bar{y},z [u,v,\bar{w}]$
	(3) $\bar{x},y,\bar{z} [u,\bar{v},w]$	(4) $x,\bar{y},\bar{z} [u,\bar{v},\bar{w}]$
2 g ..2'	$0,0,z [u,v,0]$	$0,0,\bar{z} [u,\bar{v},0]$
2 f .2.	$0,y,1/2 [0,v,0]$	$0,\bar{y},1/2 [0,v,0]$
2 e .2'.	$0,y,0 [u,0,w]$	$0,\bar{y},0 [u,0,\bar{w}]$
2 d 2'..	$x,0,1/2 [0,v,w]$	$\bar{x},0,1/2 [0,v,\bar{w}]$
2 c 2..	$x,0,0 [u,0,0]$	$\bar{x},0,0 [u,0,0]$
1 b 2'22'	$0,0,1/2 [0,v,0]$	
1 a 2'22'	$0,0,0 [u,0,0]$	

Symmetry of special projections

Along [001] $2mm1'$	Along [100] $p_{2a^*}2mm$	Along [010] $p_{2a^*}2mm$
Origin at $0,0,z$	$a^* = c$ Origin at $x,0,0$	$a^* = c$ Origin at $0,y,1/2$

$p_{2c}222$

No. 13.6.61

2221'

$p_{2c}222$

Orthorhombic

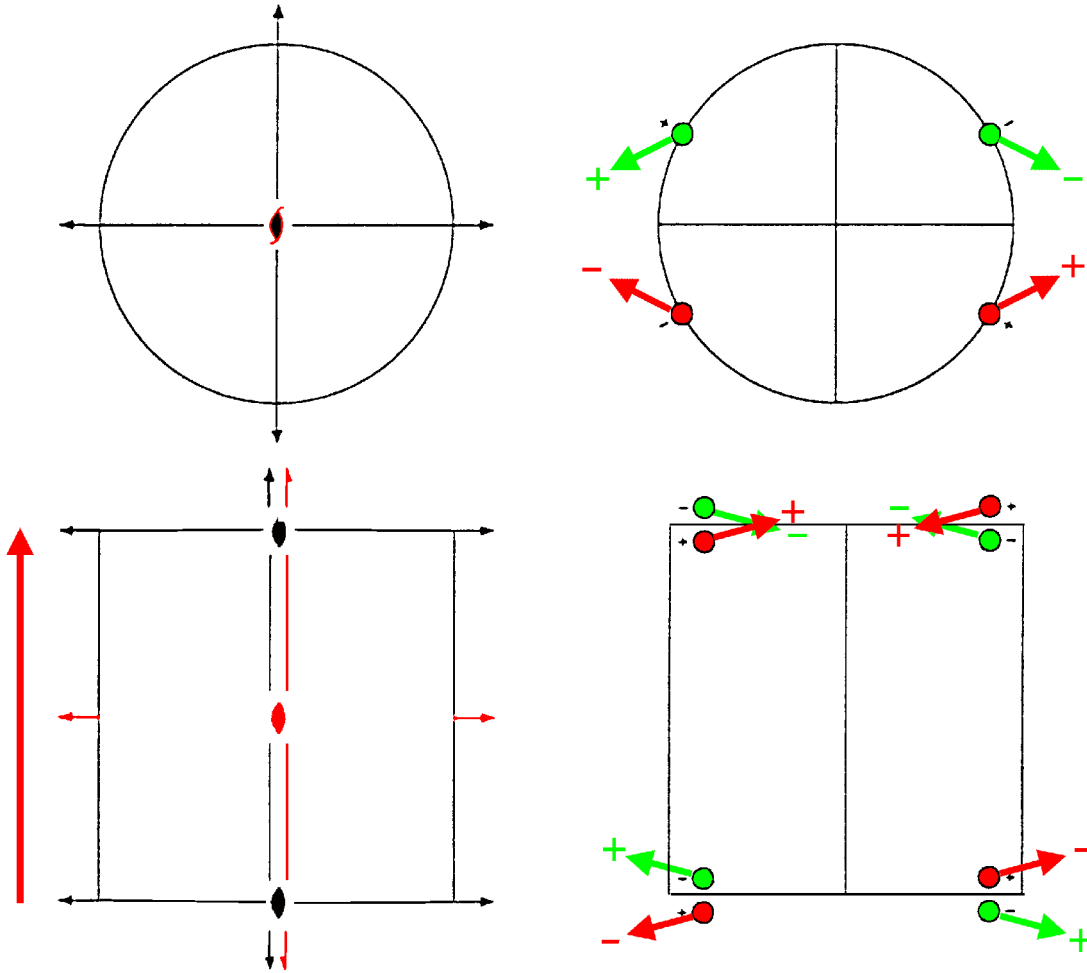

Origin at 222

Asymmetric unit $0 \leq x; 0 \leq y; 0 \leq z \leq 1$

Symmetry operations

For (0,0,0) + set

(1) 1	(2) 2 0,0,z	(3) 2 0,y,0	(4) 2 x,0,0
(1 0,0,0)	(2 _z 0,0,0)	(2 _y 0,0,0)	(2 _x 0,0,0)

For (0,0,1)' + set

(1) t' (0,0,1)	(2) 2' (0,0,1) 0,0,z	(3) 2' 0,y,1/2	(4) 2' x,0,1/2
(1 0,0,1)'	(2 _z 0,0,1)'	(2 _y 0,0,1)'	(2 _x 0,0,1)'

Generators selected (1); $t(0,0,1)'$; (2); (3)

Positions

Multiplicity, Wyckoff letter, Site symmetry	Coordinates	
		$(0,0,0)_+$ $(0,0,1)'$ +
4 h 1	(1) x,y,z [u,v,w]	(2) \bar{x},\bar{y},z [\bar{u},\bar{v},w]
	(3) \bar{x},y,\bar{z} [\bar{u},v,\bar{w}]	(4) x,\bar{y},\bar{z} [u,\bar{v},\bar{w}]
2 g ..2	$0,0,z$ [$0,0,w$]	$0,0,\bar{z}$ [$0,0,\bar{w}$]
2 f .2'	$0,y,1/2$ [$u,0,w$]	$0,\bar{y},1/2$ [$\bar{u},0,w$]
2 e .2.	$0,y,0$ [$0,v,0$]	$0,\bar{y},0$ [$0,\bar{v},0$]
2 d 2'..	$x,0,1/2$ [$0,v,w$]	$\bar{x},0,1/2$ [$0,\bar{v},w$]
2 c 2..	$x,0,0$ [$u,0,0$]	$\bar{x},0,0$ [$\bar{u},0,0$]
1 b 2'2'2	$0,0,1/2$ [$0,0,w$]	
1 a 222	$0,0,0$ [$0,0,0$]	

Symmetry of special projections

Along [001] $2mm1'$	Along [100] $p_{2a^*}2m'm'$	Along [010] $p_{2a^*}2m'm'$
Origin at $0,0,z$	$\mathbf{a}^* = \mathbf{c}$ Origin at $x,0,0$	$\mathbf{a}^* = \mathbf{c}$ Origin at $0,y,0$

$p222_1$

222

Orthorhombic

No. 14.1.62

$p222_1$

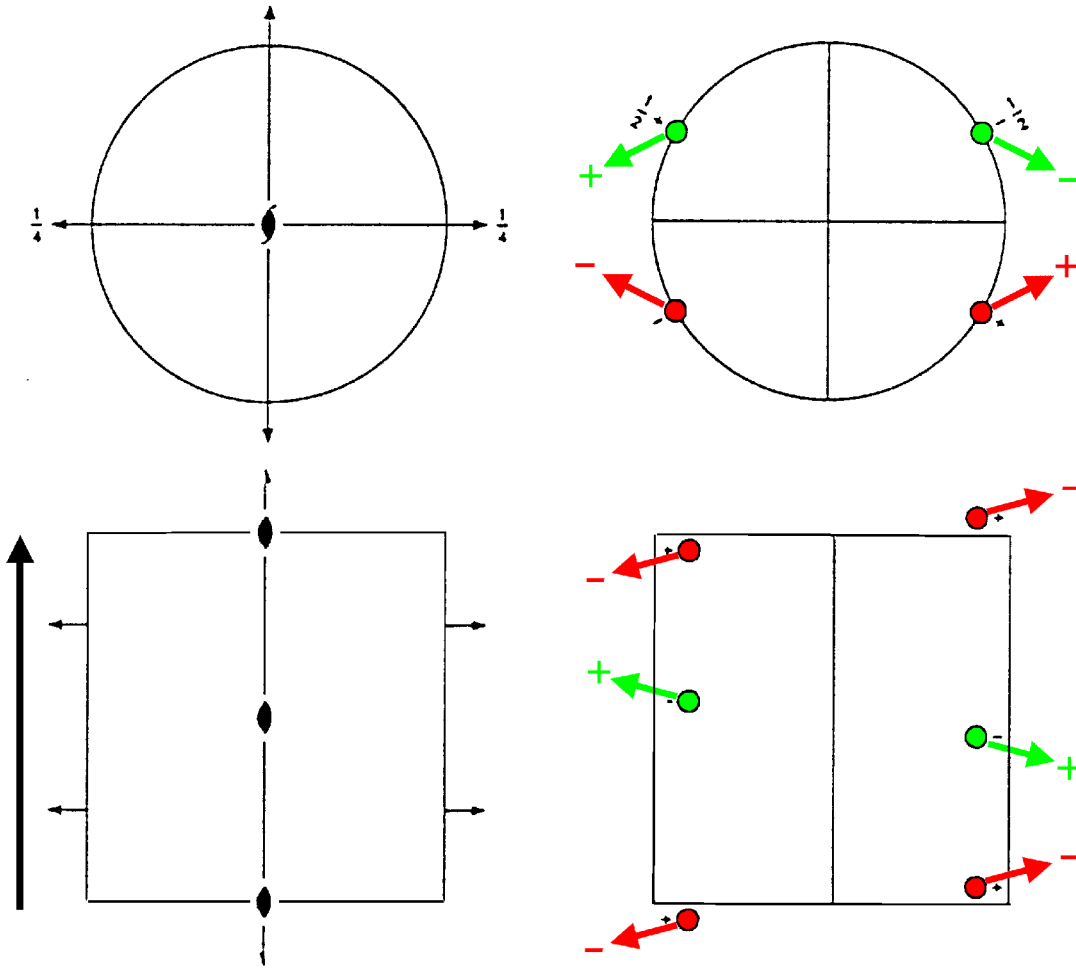

Origin at 212_1

Asymmetric unit $0 \leq x; 0 \leq y; 0 \leq z \leq 1$

Symmetry operations

- (1) 1
 (1|0,0,0) (2) $2(0,0,1/2) \ 0,0,z$ (3) $2 \ 0,y,1/4$ (4) $2 \ x,0,0$
 (2_z|0,0,1/2) (2_y|0,0,1/2) (2_x|0,0,0)

Generators selected (1); $t(0,0,1)$; (2); (3)

Positions

Multiplicity, Wyckoff letter, Site symmetry	Coordinates	
	(1) x, y, z [u, v, w]	(2) $\bar{x}, \bar{y}, z + 1/2$ [\bar{u}, \bar{v}, w]
4 c 1	(3) $\bar{x}, y, \bar{z} + 1/2$ [\bar{u}, v, \bar{w}]	(4) x, \bar{y}, \bar{z} [u, \bar{v}, \bar{w}]
2 b .2.	0, y, 1/4 [0, v, 0]	0, \bar{y} , 3/4 [0, \bar{v} , 0]
2 a 2..	x, 0, 0 [u, 0, 0]	\bar{x} , 0, 1/2 [\bar{u} , 0, 0]

Symmetry of special projections

Along [001] 2mm	Along [100] $p2m'g'$ $a^* = c$	Along [010] $p2m'g'$ $a^* = c$
Origin at 0, 0, z	Origin at x, 0, 0	Origin at 0, y, 1/4

$p222_11'$

$2221'$

Orthorhombic

No. 14.2.63

$p222_11'$
1'

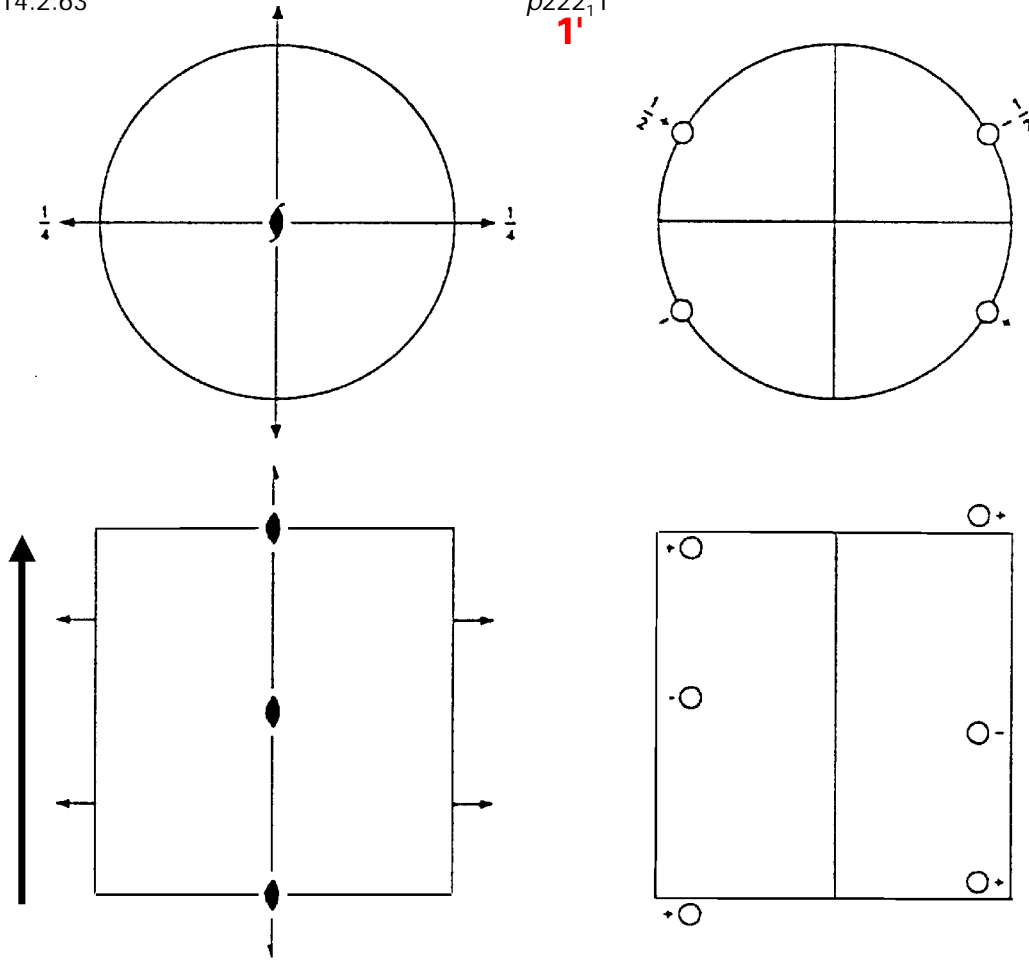

Origin at $212_11'$

Asymmetric unit $0 \leq x; 0 \leq y; 0 \leq z \leq 1$

Symmetry operations

For 1 + set

(1) 1	(2) $2(0,0,1/2)$	$0,0,z$	(3) $2(0,y,1/4)$	(4) $2(x,0,0)$
$(1 0,0,0)$	$(2_z 0,0,1/2)$		$(2_y 0,0,1/2)$	$(2_x 0,0,0)$

For 1' + set

(1) 1'	(2) $2'(0,0,1/2)$	$0,0,z$	(3) $2'(0,y,1/4)$	(4) $2'(x,0,0)$
$(1 0,0,0)'$	$(2_z 0,0,1/2)'$		$(2_y 0,0,1/2)'$	$(2_x 0,0,0)'$

Generators selected (1); $t(0,0,1)$; (2); (3); $1'$

Positions

Multiplicity, Wyckoff letter, Site symmetry	Coordinates	
		1+ 1' +
4 c 11'	(1) x,y,z [0,0,0]	(2) $\bar{x},\bar{y},z+1/2$ [0,0,0]
	(3) $\bar{x},y,\bar{z}+1/2$ [0,0,0]	(4) x,\bar{y},\bar{z} [0,0,0]
2 b .2.1'	$0,y,1/4$ [0,0,0]	$0,\bar{y},3/4$ [0,0,0]
2 a 2..1'	$x,0,0$ [0,0,0]	$\bar{x},0,1/2$ [0,0,0]

Symmetry of special projections

Along [001] $2mm1'$	Along [100] $p2mg1'$	Along [010] $p2mg1'$
Origin at 0,0,z	$a^* = c$ Origin at $x,0,0$	$a^* = c$ Origin at $0,y,1/4$

$p2'2'2_1$

$2'2'2$

Orthorhombic

No. 14.3.64

$p2'2'2_1$

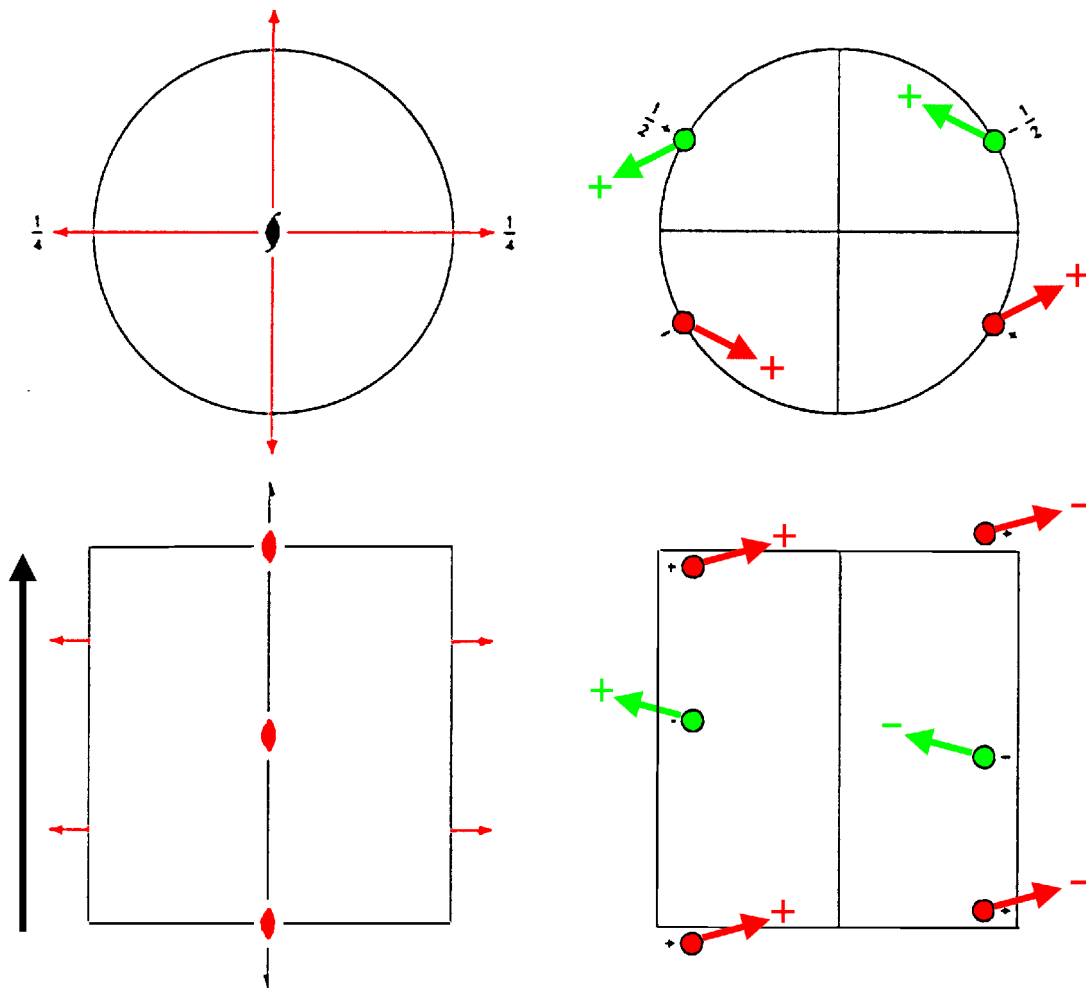

Origin at $2'12_1$

Asymmetric unit $0 \leq x; 0 \leq y; 0 \leq z \leq 1$

Symmetry operations

- (1) 1 (1|0,0,0) (2) $2(0,0,1/2)$ $0,0,z$ $(2_z|0,0,1/2)$ (3) $2'(0,y,1/4)$ $(2_y|0,0,1/2)'$ (4) $2'(x,0,0)$ $(2_x|0,0,0)'$

Generators selected (1); $t(0,0,1)$; (2); (3)

Positions

Multiplicity, Wyckoff letter, Site symmetry	Coordinates	
	(1) x, y, z [u, v, w]	(2) $\bar{x}, \bar{y}, z + 1/2$ [\bar{u}, \bar{v}, w]
4 c 1	(3) $\bar{x}, y, \bar{z} + 1/2$ [u, \bar{v}, w]	(4) x, \bar{y}, \bar{z} [\bar{u}, v, w]
2 b .2'	$0, y, 1/4$ [u, 0, w]	$0, \bar{y}, 3/4$ [$\bar{u}, 0, w$]
2 a 2'..	$x, 0, 0$ [0, v, w]	$\bar{x}, 0, 1/2$ [0, \bar{v}, w]

Symmetry of special projections

Along [001] $2mm$	Along [100] $p2'mg'$ $a^* = c$	Along [010] $p2'mg'$ $a^* = c$
Origin at $0, 0, z$	Origin at $x, 0, 0$	Origin at $0, y, 1/4$

$p22'2_1'$

$22'2'$

Orthorhombic

No. 14.4.65

$p22'2_1'$

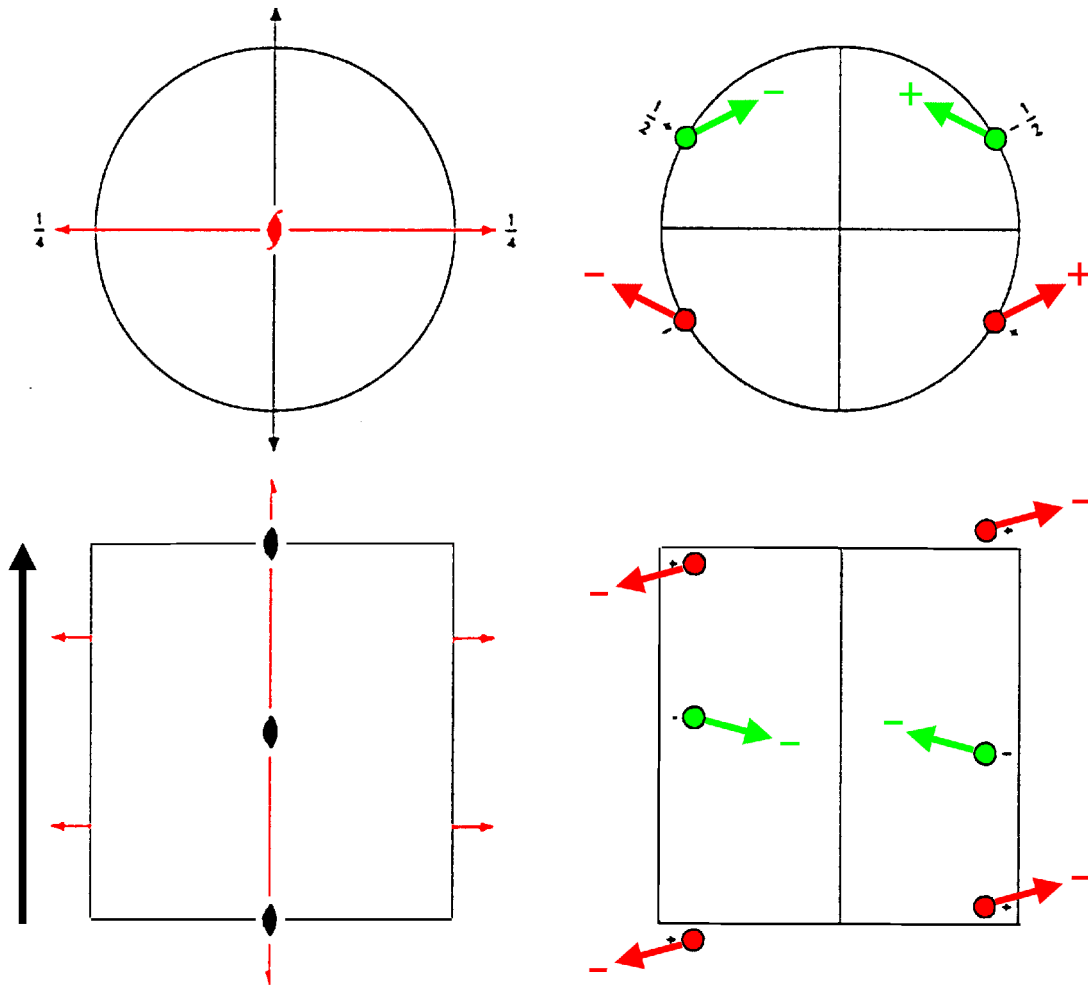

Origin at $212_1'$

Asymmetric unit $0 \leq x; 0 \leq y; 0 \leq z \leq 1$

Symmetry operations

- (1) 1 (1|0,0,0) (2) $2' (0,0,1/2) 0,0,z$ ($2_z|0,0,1/2$)' (3) $2' 0,y,1/4$ ($2_y|0,0,1/2$)' (4) $2 x,0,0$ ($2_x|0,0,0$)

Generators selected (1); $t(0,0,1)$; (2); (3)

Positions

Multiplicity, Wyckoff letter, Site symmetry	Coordinates	
	(1) x, y, z $[u, v, w]$	(2) $\bar{x}, \bar{y}, z + 1/2$ $[u, v, \bar{w}]$
4 c 1	(3) $\bar{x}, y, \bar{z} + 1/2$ $[u, \bar{v}, w]$	(4) x, \bar{y}, \bar{z} $[u, \bar{v}, \bar{w}]$
2 b $2'$	$0, y, 1/4$ $[u, 0, w]$	$0, \bar{y}, 3/4$ $[u, 0, \bar{w}]$
2 a $2..$	$x, 0, 0$ $[u, 0, 0]$	$\bar{x}, 0, 1/2$ $[u, 0, 0]$

Symmetry of special projections

Along $[001]$ $2'mm'$	Along $[100]$ $p2mg$	Along $[010]$ $p2'm'g$
Origin at $0, 0, z$	$a^* = c$ Origin at $x, 0, 0$	$a^* = c$ Origin at $0, y, 1/4$

*pmm*2

No. 15.1.66

*mm*2

*pmm*2

Orthorhombic

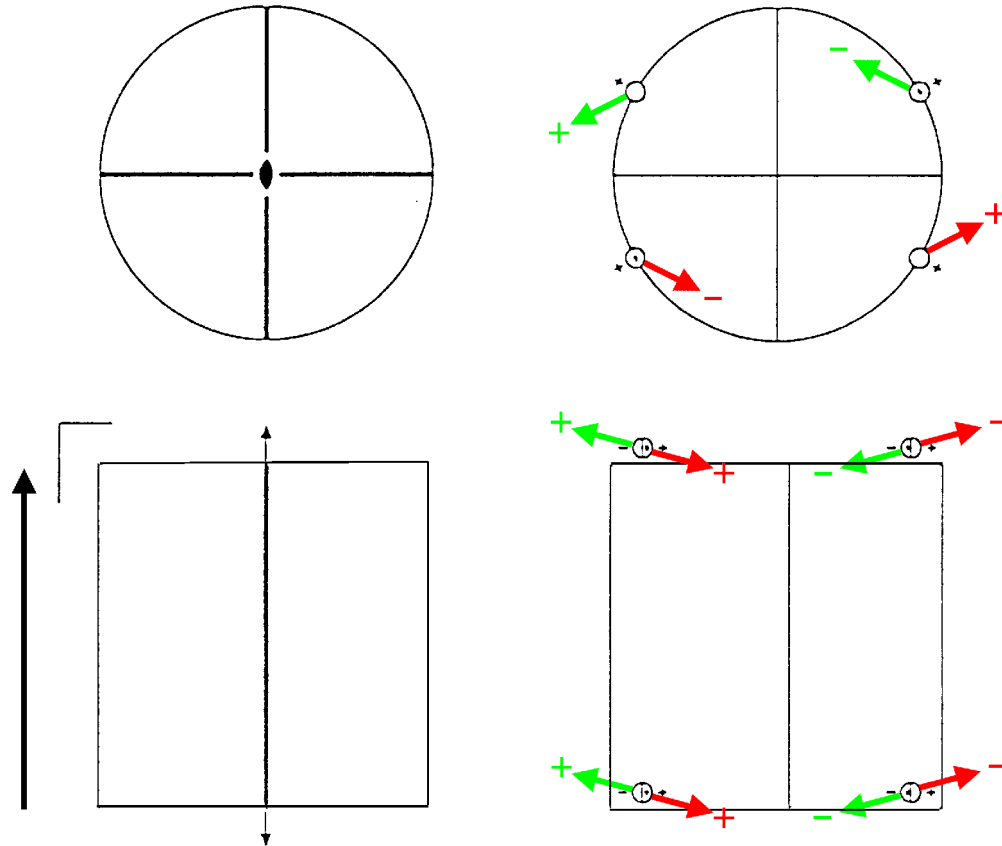

Origin on *mm*2

Asymmetric unit $0 \leq x$; $0 \leq y$; $0 \leq z \leq 1$

Symmetry operations

(1) 1
(1|0,0,0)

(2) 2 $0,0,z$
(2_z |0,0,0)

(3) m $x,0,z$
(m_y |0,0,0)

(4) m $0,y,z$
(m_x |0,0,0)

Generators selected (1); $t(0,0,1)$; (2); (3)

Positions

Multiplicity, Wyckoff letter, Site symmetry	Coordinates			
	(1) x,y,z [u,v,w]	(2) \bar{x},\bar{y},z [\bar{u},\bar{v},w]	(3) x,\bar{y},z [\bar{u},v,\bar{w}]	(4) \bar{x},y,z [u,\bar{v},\bar{w}]
4 d 1	(1) x,y,z [u,v,w]	(2) \bar{x},\bar{y},z [\bar{u},\bar{v},w]	(3) x,\bar{y},z [\bar{u},v,\bar{w}]	(4) \bar{x},y,z [u,\bar{v},\bar{w}]
2 c m..	0,y,z [u,0,0]	0, \bar{y} ,z [\bar{u} ,0,0]		
2 b .m.	x,0,z [0,v,0]	\bar{x} ,0,z [0, \bar{v} ,0]		
1 a mm2	0,0,z [0,0,0]			

Symmetry of special projections

Along [001] 2mm	Along [100] $p11m1'$ $a^* = c$	Along [010] $p11m1'$ $a^* = c$
Origin at 0,0,z	Origin at x,0,0	Origin at 0,y,0

$pmm21'$

No. 15.2.67

$mm21'$

$pmm21'$

Orthorhombic

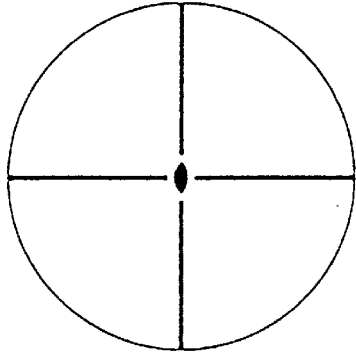

$1'$

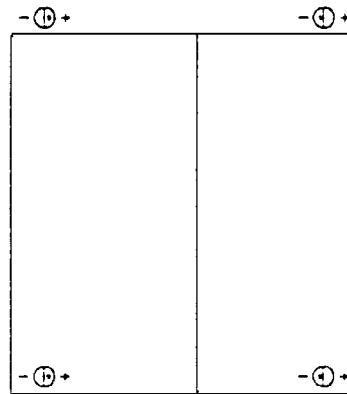
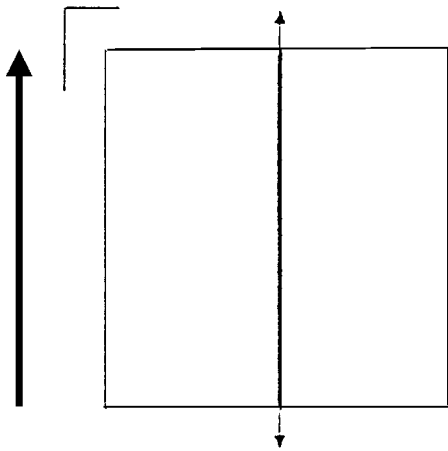
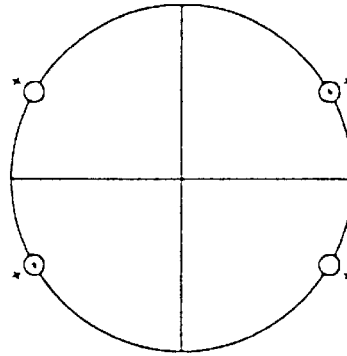

Origin on $mm21'$

Asymmetric unit $0 \leq x; 0 \leq y; 0 \leq z \leq 1$

Symmetry operations

For $1 +$ set

(1) 1	(2) $2 \quad 0,0,z$	(3) $m \quad x,0,z$	(4) $m \quad 0,y,z$
$(1 0,0,0)$	$(2_z 0,0,0)$	$(m_y 0,0,0)$	$(m_x 0,0,0)$

For $1' +$ set

(1) $1'$	(2) $2' \quad 0,0,z$	(3) $m' \quad x,0,z$	(4) $m' \quad 0,y,z$
$(1 0,0,0)'$	$(2_z 0,0,0)'$	$(m_y 0,0,0)'$	$(m_x 0,0,0)'$

Generators selected (1); $t(0,0,1)$; (2); (3); 1'

Positions

Multiplicity, Wyckoff letter, Site symmetry	Coordinates			
		1+	1' +	
4 d 11'	(1) $x,y,z [0,0,0]$	(2) $\bar{x},\bar{y},z [0,0,0]$	(3) $x,\bar{y},z [0,0,0]$	(4) $\bar{x},y,z [0,0,0]$
2 c m..1'	$0,y,z [0,0,0]$	$0,\bar{y},z [0,0,0]$		
2 b .m.1'	$x,0,z [0,0,0]$	$\bar{x},0,z [0,0,0]$		
1 a mm21'	$0,0,z [0,0,0]$			

Symmetry of special projections

Along [001] 2mm1'	Along [100] p11m1'	Along [010] p11m1'
Origin at 0,0,z	$a^* = c$ Origin at x,0,0	$a^* = c$ Origin at 0,y,0

$pm'm'2$

No. 15.3.68

$m'm'2$

$pm'm'2$

Orthorhombic

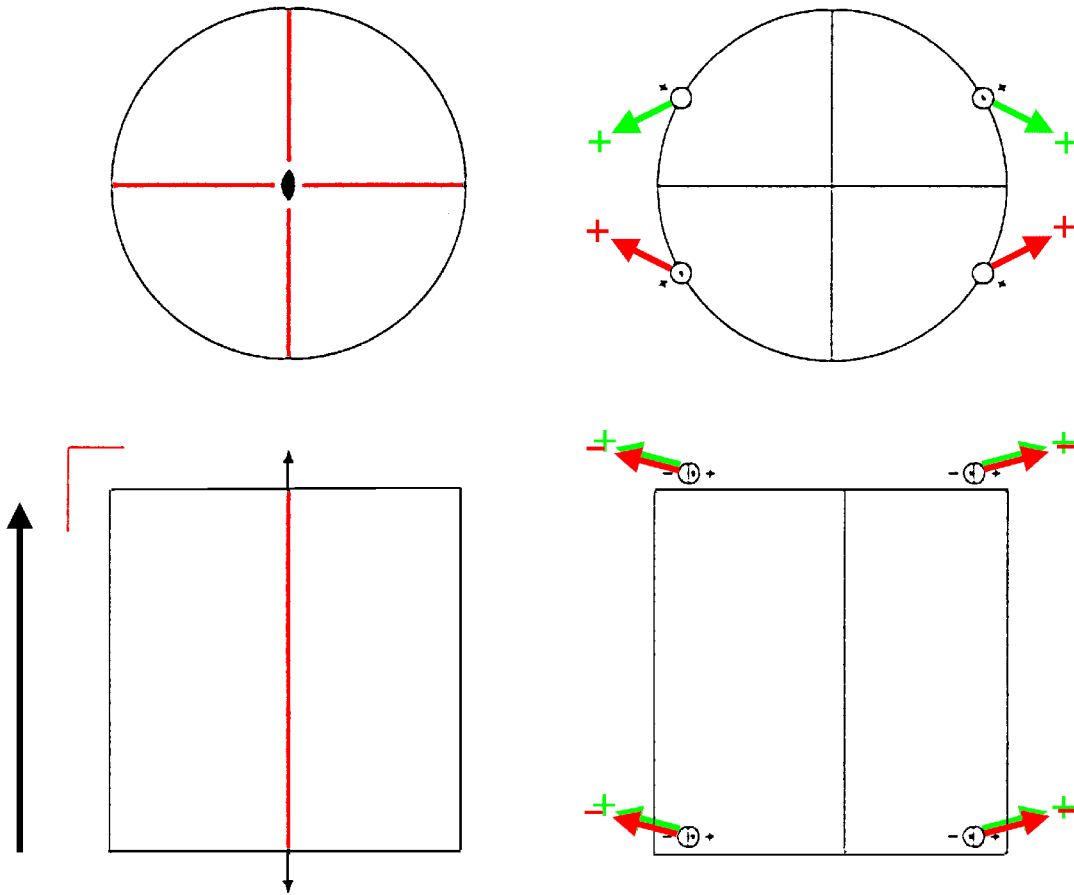

Origin on $m'm'2$

Asymmetric unit $0 \leq x; 0 \leq y; 0 \leq z \leq 1$

Symmetry operations

(1) 1
(1|0,0,0)

(2) $2_{0,0,z}$
(2_z |0,0,0)

(3) m'_x x,0,z
(m_y |0,0,0)'

(4) m'_0 0,y,z
(m_x |0,0,0)'

Generators selected (1); $t(0,0,1)$; (2); (3)

Positions

Multiplicity, Wyckoff letter, Site symmetry	Coordinates			
	(1) x,y,z [u,v,w]	(2) \bar{x},\bar{y},z [\bar{u},\bar{v},w]	(3) x,\bar{y},z [u,\bar{v},w]	(4) \bar{x},y,z [\bar{u},v,w]
4 d 1	(1) x,y,z [u,v,w]	(2) \bar{x},\bar{y},z [\bar{u},\bar{v},w]	(3) x,\bar{y},z [u,\bar{v},w]	(4) \bar{x},y,z [\bar{u},v,w]
2 c $m'..$	$0,y,z$ [$0,v,w$]	$0,\bar{y},z$ [$0,\bar{v},w$]		
2 b $.m'$	$x,0,z$ [$u,0,w$]	$\bar{x},0,z$ [$\bar{u},0,w$]		
1 a $m'm'2$	$0,0,z$ [$0,0,w$]			

Symmetry of special projections

Along [001] $2m'm'$	Along [100] $p11m'$	Along [010] $p11m'$
Origin at $0,0,z$	$a^* = c$ Origin at $x,0,0$	$a^* = c$ Origin at $0,y,0$

$pmm'2'$

No. 15.4.69

$mm'2'$

$pmm'2'$

Orthorhombic

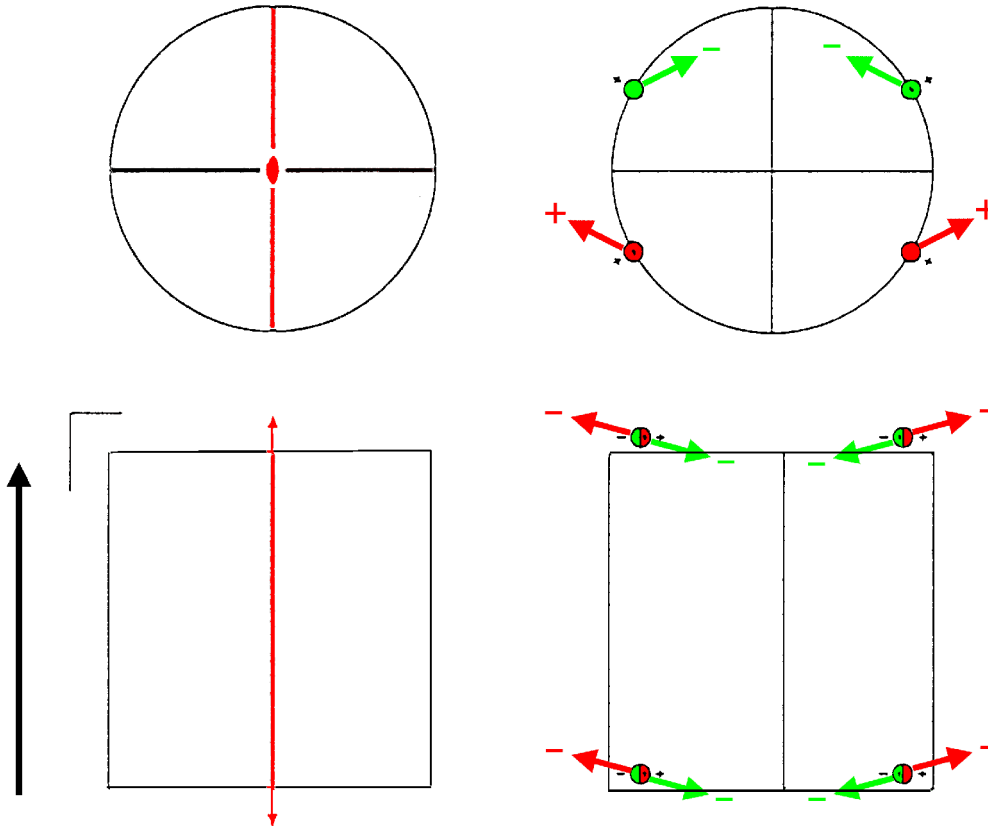

Origin on $mm'2'$

Asymmetric unit $0 \leq x$; $0 \leq y$; $0 \leq z \leq 1$

Symmetry operations

(1) 1
(1|0,0,0)

(2) $2'_z$ 0,0,z
(2_z |0,0,0)'

(3) m'_x x,0,z
(m_y |0,0,0)'

(4) m'_y 0,y,z
(m_x |0,0,0)

Generators selected (1); $t(0,0,1)$; (2); (3)

Positions

Multiplicity, Wyckoff letter, Site symmetry	Coordinates			
	(1) x,y,z [u,v,w]	(2) \bar{x},\bar{y},z [u,v, \bar{w}]	(3) x,\bar{y},z [u, \bar{v} ,w]	(4) \bar{x},y,z [u, \bar{v} , \bar{w}]
4 d 1	(1) x,y,z [u,v,w]	(2) \bar{x},\bar{y},z [u,v, \bar{w}]	(3) x,\bar{y},z [u, \bar{v} ,w]	(4) \bar{x},y,z [u, \bar{v} , \bar{w}]
2 c m..	0,y,z [u,0,0]	0, \bar{y} ,z [u,0,0]		
2 b .m'	x,0,z [u,0,w]	\bar{x} ,0,z [u,0, \bar{w}]		
1 a $mm'2'$	0,0,z [u,0,0]			

Symmetry of special projections

Along [001] $2'mm'$	Along [100] $p11m1'$	Along [010] $p11m$
Origin at 0,0,z	$a^* = c$ Origin at x,0,0	$a^* = c$ Origin at 0,y,0

$p_{2c}m'm'2$

No. 15.5.70

$mm21'$

$p_{2c}m'm'2$

Orthorhombic

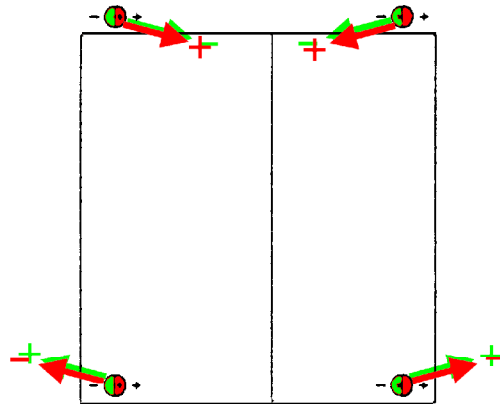
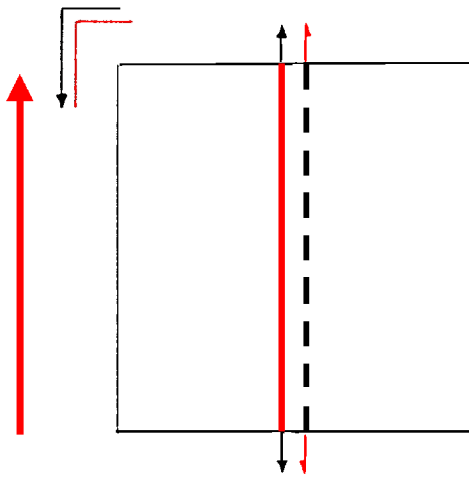
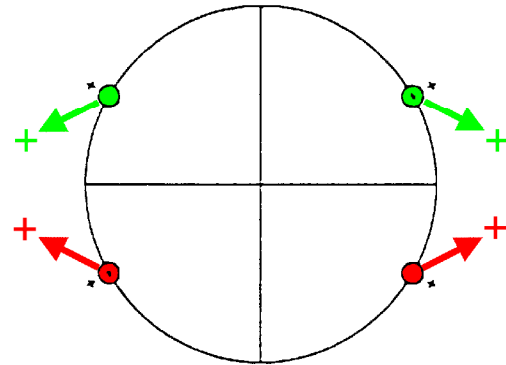
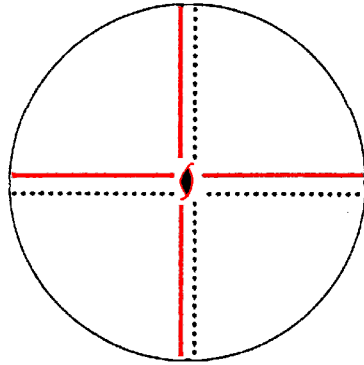

Origin on $m'm'2$

Asymmetric unit $0 \leq x; 0 \leq y; 0 \leq z \leq 1$

Symmetry operations

- For $(0,0,0) +$ set
- | | | | |
|-------------|-----------------|------------------|------------------|
| (1) 1 | (2) $2 \ 0,0,z$ | (3) $m' \ x,0,z$ | (4) $m' \ 0,y,z$ |
| $(1 0,0,0)$ | $(2_z 0,0,0)$ | $(m_y 0,0,0)'$ | $(m_x 0,0,0)'$ |
- For $(0,0,1)'$ + set
- | | | | |
|--------------------|----------------------------|---------------------------|---------------------------|
| (1) $t' \ (0,0,1)$ | (2) $2' \ (0,0,1) \ 0,0,z$ | (3) $c \ (0,0,1) \ x,0,z$ | (4) $c \ (0,0,1) \ 0,y,z$ |
| $(1 0,0,1)'$ | $(2_z 0,0,1)'$ | $(m_y 0,0,1)$ | $(m_x 0,0,1)$ |

Generators selected (1); $t(0,0,1)'$; (2); (3)

Positions

		Coordinates			
Multiplicity, Wyckoff letter, Site symmetry		(0,0,0)+	(0,0,1)'		
4	d 1	(1) $x,y,z [u,v,w]$	(2) $\bar{x},\bar{y},z [\bar{u},\bar{v},w]$	(3) $x,\bar{y},z [u,\bar{v},w]$	(4) $\bar{x},y,z [\bar{u},v,w]$
2	c $m'..$	$0,y,z [0,v,w]$	$0,\bar{y},z [0,\bar{v},w]$		
2	b $.m'$	$x,0,z [u,0,w]$	$\bar{x},0,z [\bar{u},0,w]$		
1	a $m'm'2$	$0,0,z [0,0,w]$			

Symmetry of special projections

Along [001] $2mm'1'$	Along [100] $p_{2a^*}11m'$	Along [010] $p_{2a^*}11m'$
Origin at 0,0,z	$a^* = c$ Origin at x,0,0	$a^* = c$ Origin at 0,y,0

$\rho_{2c}mm'2'$

$mm21'$

Orthorhombic

No. 15.6.71

$\rho_{2c}mm'2'$

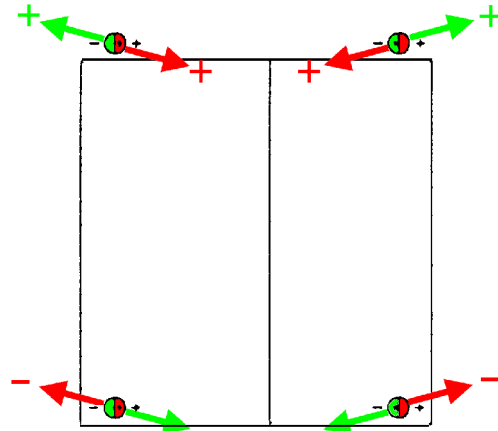
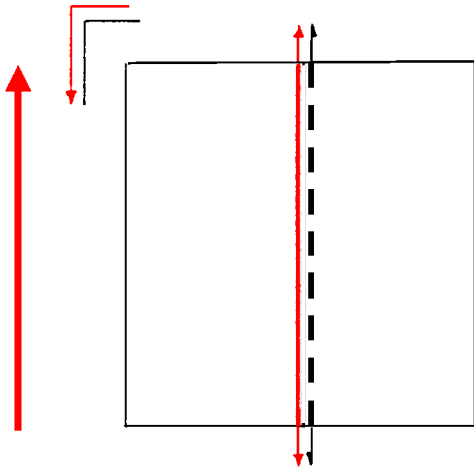
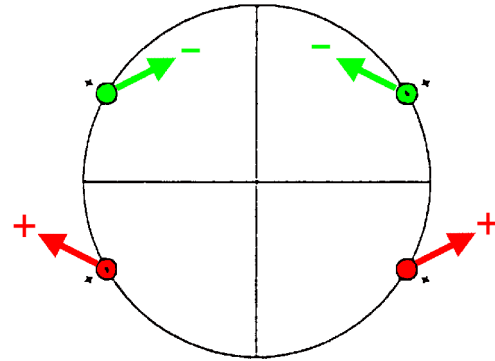
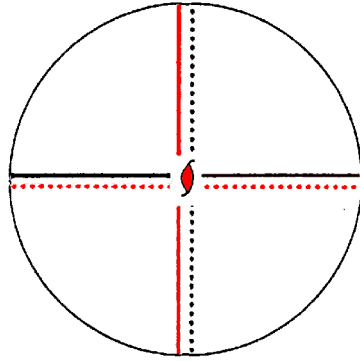

Origin on $mm'2'$

Asymmetric unit $0 \leq x; 0 \leq y; 0 \leq z \leq 1$

Symmetry operations

- | | | | |
|----------------------|---------------------------|---------------------------|----------------------------|
| For $(0,0,0) +$ set | | | |
| (1) 1 | (2) $2' \ 0,0,z$ | (3) $m' \ x,0,z$ | (4) $m \ 0,y,z$ |
| $(1 0,0,0)$ | $(2_z 0,0,0)'$ | $(m_y 0,0,0)'$ | $(m_x 0,0,0)$ |
| For $(0,0,1)'$ + set | | | |
| (1) $t' \ (0,0,1)$ | (2) $2 \ (0,0,1) \ 0,0,z$ | (3) $c \ (0,0,1) \ x,0,z$ | (4) $c' \ (0,0,1) \ 0,y,z$ |
| $(1 0,0,1)'$ | $(2_z 0,0,1)$ | $(m_y 0,0,1)$ | $(m_x 0,0,1)'$ |

Generators selected (1); $t(0,0,1)'$; (2); (3)

Positions

Multiplicity, Wyckoff letter, Site symmetry	Coordinates			
	(1) $x,y,z [u,v,w]$	(2) $\bar{x},\bar{y},z [u,v,\bar{w}]$	(3) $x,\bar{y},z [u,\bar{v},w]$	(4) $\bar{x},y,z [u,\bar{v},\bar{w}]$
4 d 1	$(0,0,0)_+$	$(0,0,1)'$	$(0,0,0)_+$	$(0,0,1)'$
2 c m..	$0,y,z [u,0,0]$	$0,\bar{y},z [u,0,0]$	$0,y,z [u,0,0]$	$0,\bar{y},z [u,0,0]$
2 b .m'	$x,0,z [u,0,w]$	$\bar{x},0,z [u,0,\bar{w}]$	$x,0,z [u,0,w]$	$\bar{x},0,z [u,0,\bar{w}]$
1 a mm'2'	$0,0,z [u,0,0]$			

Symmetry of special projections

Along [001] $2mm'1'$	Along [100] $p11m'1'$	Along [010] $p_{2a^*}11m$
Origin at $0,0,z$	$a^* = c$ Origin at $x,0,0$	$a^* = c$ Origin at $0,y,0$

$p_{2c}mm2$

$mm21'$

Orthorhombic

No. 15.7.72

$p_{2c}mm2$

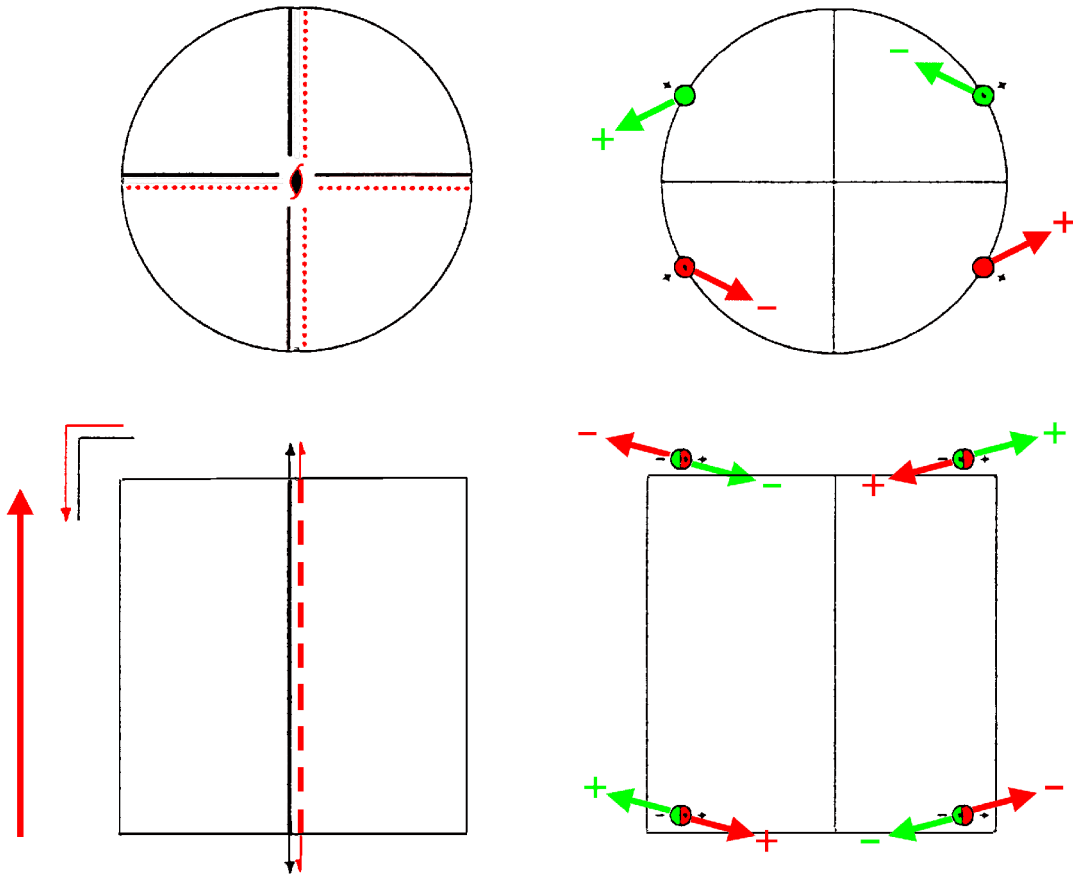

Origin on $mm2$

Asymmetric unit $0 \leq x; 0 \leq y; 0 \leq z \leq 1$

Symmetry operations

- For $(0,0,0) +$ set
- | | | | |
|-------------|-----------------|-----------------|-----------------|
| (1) 1 | (2) $2 \ 0,0,z$ | (3) $m \ x,0,z$ | (4) $m \ 0,y,z$ |
| $(1 0,0,0)$ | $(2_z 0,0,0)$ | $(m_y 0,0,0)$ | $(m_x 0,0,0)$ |
- For $(0,0,1)'$ + set
- | | | | |
|--------------------|----------------------------|----------------------------|----------------------------|
| (1) $t' \ (0,0,1)$ | (2) $2' \ (0,0,1) \ 0,0,z$ | (3) $c' \ (0,0,1) \ x,0,z$ | (4) $c' \ (0,0,1) \ 0,y,z$ |
| $(1 0,0,1)'$ | $(2_z 0,0,1)'$ | $(m_y 0,0,1)'$ | $(m_x 0,0,1)'$ |

Generators selected (1); $t(0,0,1)'$; (2); (3)

Positions

		Coordinates			
Multiplicity, Wyckoff letter, Site symmetry		(0,0,0)+	(0,0,1)'		
4	d 1	(1) $x,y,z [u,v,w]$	(2) $\bar{x},\bar{y},z [\bar{u},\bar{v},w]$	(3) $x,\bar{y},z [\bar{u},v,\bar{w}]$	(4) $\bar{x},y,z [u,\bar{v},\bar{w}]$
2	c m..	$0,y,z [u,0,0]$	$0,\bar{y},z [\bar{u},0,0]$		
2	b .m.	$x,0,z [0,v,0]$	$\bar{x},0,z [0,\bar{v},0]$		
1	a mm2	$0,0,z [0,0,0]$			

Symmetry of special projections

Along [001] $2mm1'$	Along [100] $p11m1'$	Along [010] $p11m1'$
Origin at $0,0,z$	$a^* = c$ Origin at $x,0,0$	$a^* = c$ Origin at $0,y,0$

pcc2

mm2

Orthorhombic

No. 16.1.73

pcc2

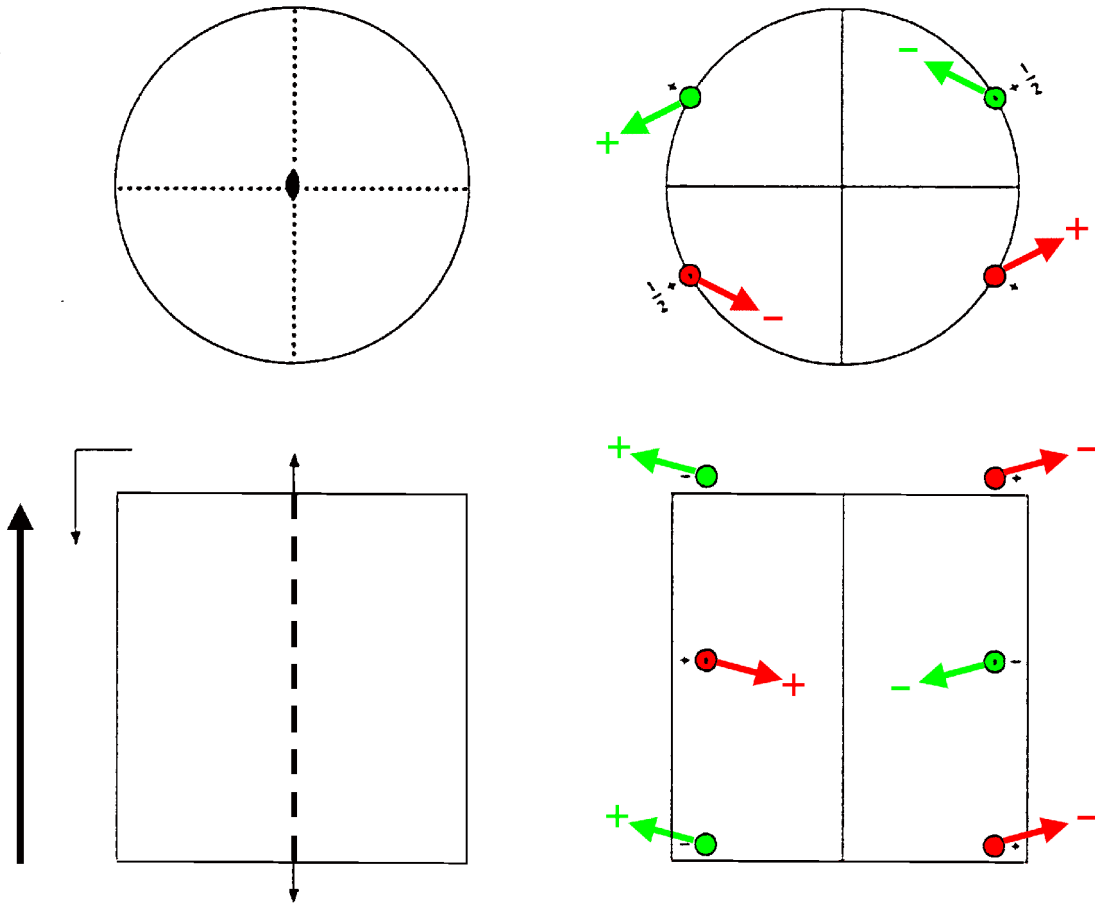

Origin on *cc2*

Asymmetric unit $0 \leq x$; $0 \leq y$; $0 \leq z \leq 1$

Symmetry operations

- | | | | |
|--------------------|----------------------------------|--|--|
| (1) 1
(1 0,0,0) | (2) 2 $0,0,z$
(2_z 0,0,0) | (3) c $(0,0,1/2)$ $x,0,z$
(m_y 0,0,1/2) | (4) c $(0,0,1/2)$ $0,y,z$
(m_x 0,0,1/2) |
|--------------------|----------------------------------|--|--|

Generators selected (1); $t(0,0,1)$; (2); (3)

Positions

Multiplicity, Wyckoff letter, Site symmetry	Coordinates	
	(1) x,y,z [u,v,w]	(2) \bar{x},\bar{y},z [\bar{u},\bar{v},w]
4 b 1	(3) $x,\bar{y},z+1/2$ [\bar{u},v,\bar{w}]	(4) $\bar{x},y,z+1/2$ [u,\bar{v},\bar{w}]
1 a ..2	0,0,z [0,0,w]	0,0,z+1/2 [0,0, \bar{w}]

Symmetry of special projections

Along [001] 2mm	Along [100] $p_{2a^*}11m'$ $a^* = c/2$	Along [010] $p_{2a^*}11m'$ $a^* = c/2$
Origin at 0,0,z	Origin at x,0,0	Origin at 0,y,0

$pcc21'$

No. 16.2.74

$mm21'$

$pcc21'$

Orthorhombic

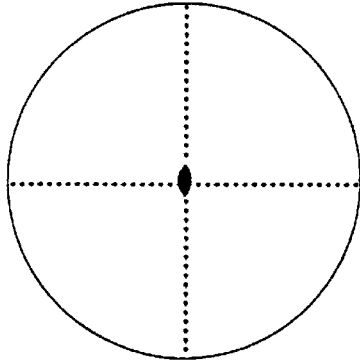

$1'$

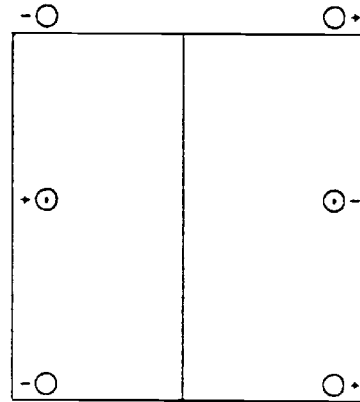
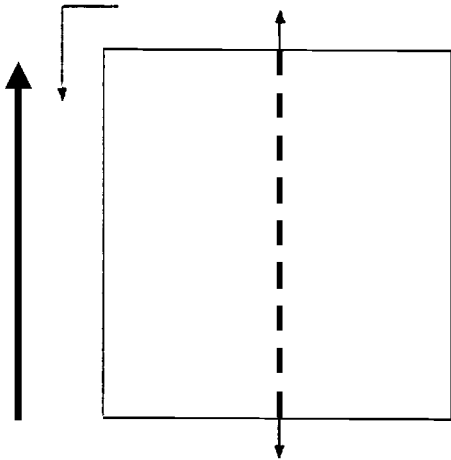
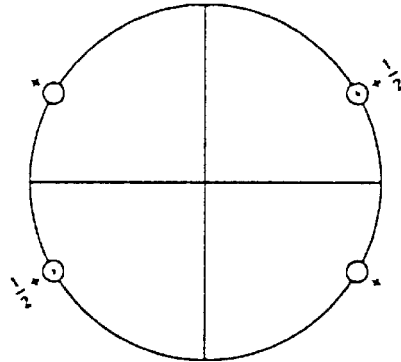

Origin on $cc21'$

Asymmetric unit $0 \leq x; 0 \leq y; 0 \leq z \leq 1$

Symmetry operations

For $1 +$ set

(1) 1	(2) $2 \quad 0,0,z$	(3) $c \quad (0,0,1/2) \quad x,0,z$	(4) $c \quad (0,0,1/2) \quad 0,y,z$
(1 0,0,0)	(2 _z 0,0,0)	(m _y 0,0,1/2)	(m _x 0,0,1/2)

For $1' +$ set

(1) $1'$	(2) $2' \quad 0,0,z$	(3) $c' \quad (0,0,1/2) \quad x,0,z$	(4) $c' \quad (0,0,1/2) \quad 0,y,z$
(1 0,0,0)'	(2 _z 0,0,0)'	(m _y 0,0,1/2)'	(m _x 0,0,1/2)'

Generators selected (1); $t(0,0,1)$; (2); (3); 1'

Positions

Multiplicity, Wyckoff letter, Site symmetry	Coordinates	
	1+	1' +
4 b 11'	(1) $x,y,z [0,0,0]$	(2) $\bar{x},\bar{y},z [0,0,0]$
	(3) $x,\bar{y},z+1/2 [0,0,0]$	(4) $\bar{x},y,z+1/2 [0,0,0]$
1 a ..21'	$0,0,z [0,0,0]$	$0,0,z+1/2 [0,0,0]$

Symmetry of special projections

Along [001] $2mm1'$	Along [100] $p11m1'$ $a^* = c/2$	Along [010] $p11m1'$ $a^* = c/2$
Origin at $0,0,z$	Origin at $x,0,0$	Origin at $0,y,0$

$pc'c'2$

$m'm'2$

Orthorhombic

No. 16.3.75

$pc'c'2$

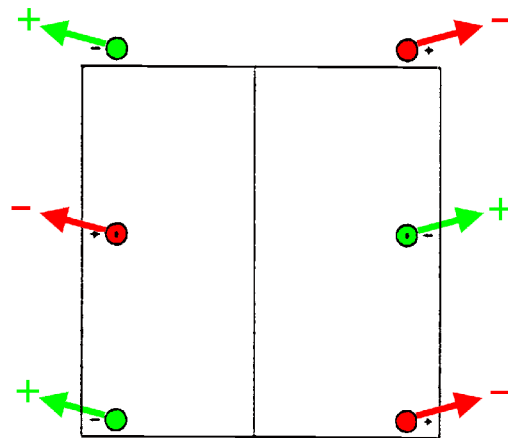
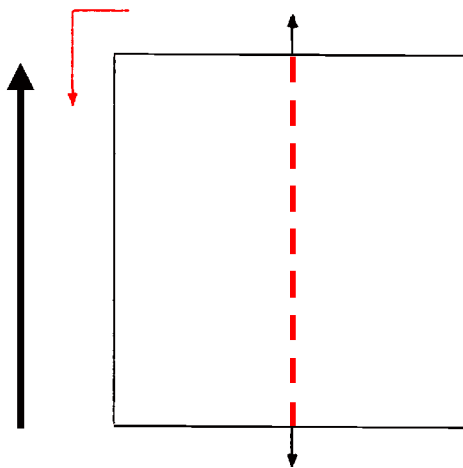
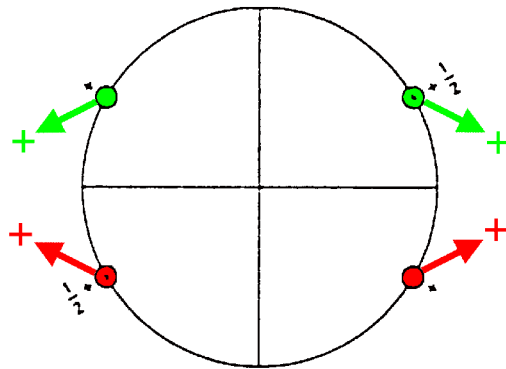
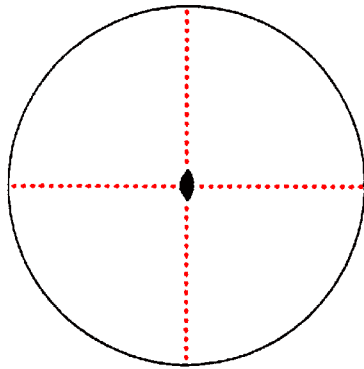

Origin on $c'c'2$

Asymmetric unit $0 \leq x$; $0 \leq y$; $0 \leq z \leq 1$

Symmetry operations

- (1) 1
(1|0,0,0)
- (2) $2_{0,0,z}$
(2_z |0,0,0)
- (3) $c'(0,0,1/2)$ $x,0,z$
(m_y |0,0,1/2)'
- (4) $c'(0,0,1/2)$ $0,y,z$
(m_x |0,0,1/2)'

Generators selected (1); $t(0,0,1)$; (2); (3)

Positions

Multiplicity, Wyckoff letter, Site symmetry	Coordinates	
	(1) x,y,z [u,v,w]	(2) \bar{x},\bar{y},z [\bar{u},\bar{v},w]
4 b 1	(3) $x,\bar{y},z+1/2$ [u, \bar{v},w]	(4) $\bar{x},y,z+1/2$ [\bar{u},v,w]
	1 a ..2	0,0,z [0,0,w]

Symmetry of special projections

Along [001] $2m'm'$	Along [100] $p11m'$	Along [010] $p11m'$
Origin at 0,0,z	$a^* = c/2$ Origin at x,0,0	$a^* = c/2$ Origin at 0,y,0

$pc'c'2'$

No. 16.4.76

$mm'2'$

$pc'c'2'$

Orthorhombic

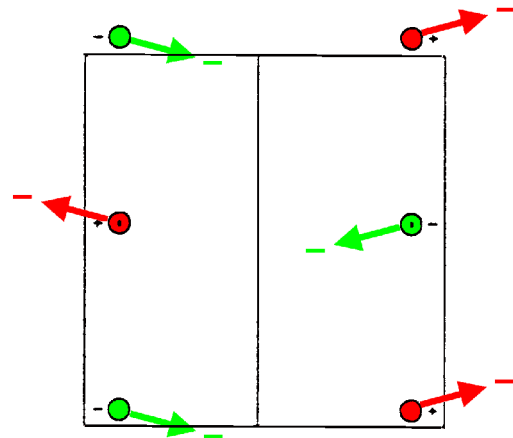
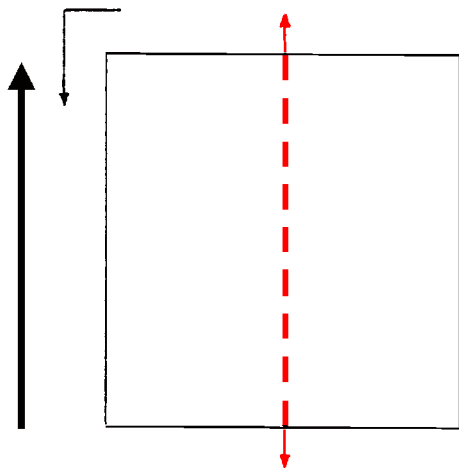
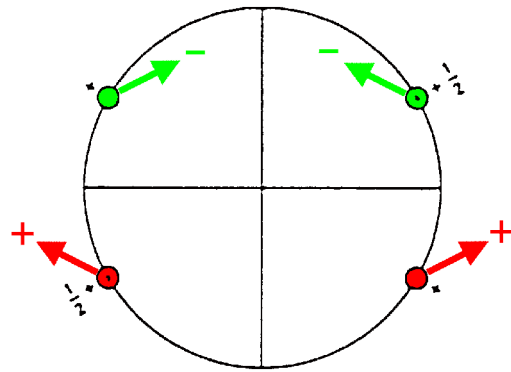
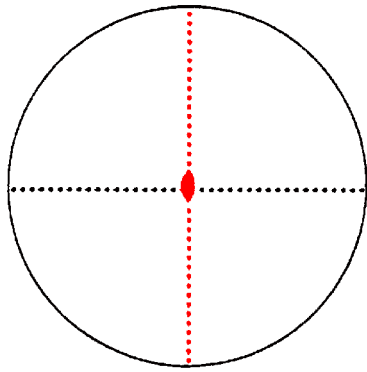

Origin on $cc'2'$

Asymmetric unit $0 \leq x$; $0 \leq y$; $0 \leq z \leq 1$

Symmetry operations

(1) 1
(1|0,0,0)

(2) $2'_z$ 0,0,z
($2'_z$ |0,0,0)

(3) c'_x (0,0,1/2) x,0,z
(m'_y |0,0,1/2)

(4) c'_y (0,0,1/2) 0,y,z
(m'_x |0,0,1/2)

Generators selected (1); $t(0,0,1)$; (2); (3)

Positions

	Coordinates	
Multiplicity, Wyckoff letter, Site symmetry		
4 b 1	(1) $x,y,z [u,v,w]$	(2) $\bar{x},\bar{y},z [u,v,\bar{w}]$
	(3) $x,\bar{y},z+1/2 [u,\bar{v},w]$	(4) $\bar{x},y,z+1/2 [u,\bar{v},\bar{w}]$
1 a ..2'	$0,0,z [u,v,0]$	$0,0,z+1/2 [u,\bar{v},0]$

Symmetry of special projections

Along [001] $2'mm'$	Along [100] $p_{2a^*}11m$	Along [010] $p11m$
	$a^* = c/2$	$a^* = c/2$
Origin at $0,0,z$	Origin at $x,0,0$	Origin at $0,y,0$

$pmc2_1$

$mm2$

Orthorhombic

No. 17.1.77

$pmc2_1$

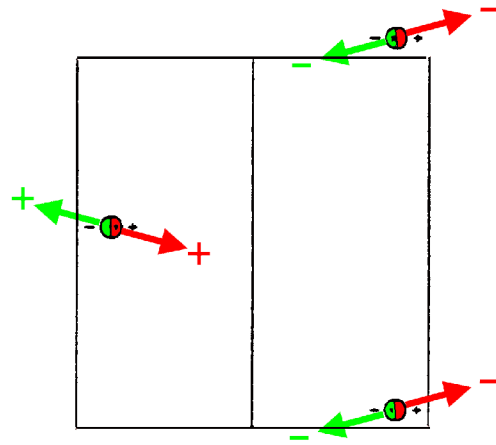
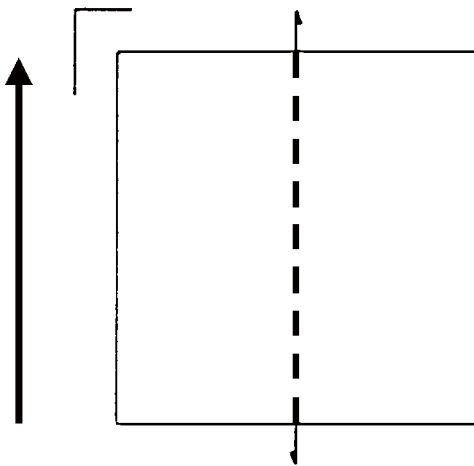
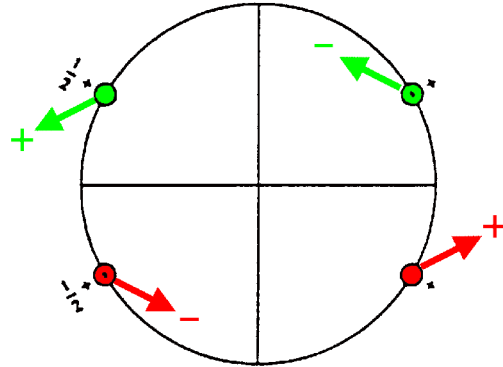
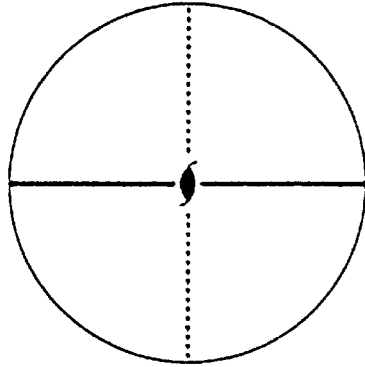

Origin on $mc2_1$

Asymmetric unit $0 \leq x; 0 \leq y; 0 \leq z \leq 1$

Symmetry operations

- (1) 1
(1|0,0,0)
- (2) $2(0,0,1/2)$ $0,0,z$
 $(2_z|0,0,1/2)$
- (3) $c(0,0,1/2)$ $x,0,z$
 $(m_y|0,0,1/2)$
- (4) m $0,y,z$
 $(m_x|0,0,0)$

Generators selected (1); t(0,0,1); (2); (3)

Positions

	Coordinates	
Multiplicity, Wyckoff letter, Site symmetry		
4 b 1	(1) x,y,z [u,v,w]	(2) $\bar{x},\bar{y},z+1/2$ [\bar{u},\bar{v},w]
	(3) $x,\bar{y},z+1/2$ [\bar{u},v,\bar{w}]	(4) \bar{x},y,z [u,\bar{v},\bar{w}]
1 a m..	0,y,z [u,0,0]	0, \bar{y} ,z+1/2 [$\bar{u},0,0$]

Symmetry of special projections

Along [001] 2mm	Along [100] p11g1' a* = c	Along [010] p _{2a*} 11m a* = c/2
Origin at 0,0,z	Origin at x,0,0	Origin at 0,y,0

$pmc2_11'$

No. 17.2.78

$mm21'$

$pmc2_11'$

Orthorhombic

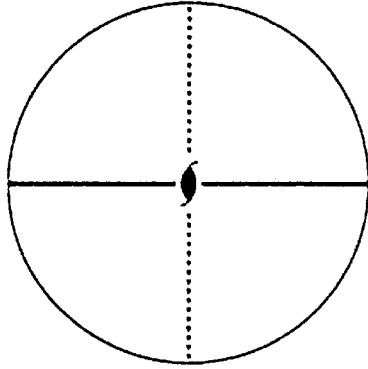

$1'$

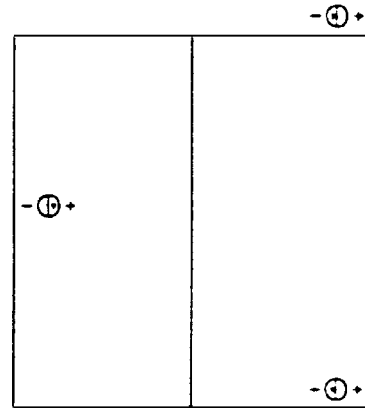
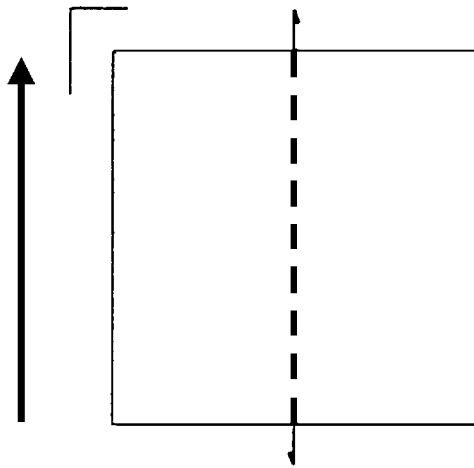
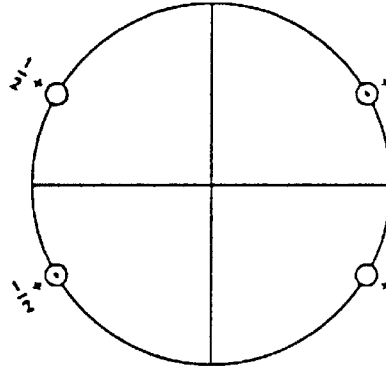

Origin on $mc2_11'$

Asymmetric unit $0 \leq x; 0 \leq y; 0 \leq z \leq 1$

Symmetry operations

For $1 +$ set

- | | | | |
|--------------------------|--|--|------------------------------------|
| (1) 1
($1 0,0,0$) | (2) 2 ($0,0,\frac{1}{2}$) $0,0,z$
($2_z 0,0,\frac{1}{2}$) | (3) c ($0,0,\frac{1}{2}$) $x,0,z$
($m_y 0,0,\frac{1}{2}$) | (4) m $0,y,z$
($m_x 0,0,0$) |
|--------------------------|--|--|------------------------------------|

For $1' +$ set

- | | | | |
|----------------------------|--|--|--------------------------------------|
| (1) $1'$
($1 0,0,0'$) | (2) $2'$ ($0,0,\frac{1}{2}$) $0,0,z$
($2_z 0,0,\frac{1}{2}'$) | (3) c' ($0,0,\frac{1}{2}$) $x,0,z$
($m_y 0,0,\frac{1}{2}'$) | (4) m' $0,y,z$
($m_x 0,0,0'$) |
|----------------------------|--|--|--------------------------------------|

Generators selected (1); $t(0,0,1)$; (2); (3); $1'$

Positions

Multiplicity, Wyckoff letter, Site symmetry	Coordinates	
	$1+$	$1' +$
4 b $11'$	(1) $x,y,z [0,0,0]$	(2) $\bar{x},\bar{y},z+1/2 [0,0,0]$
	(3) $x,\bar{y},z+1/2 [0,0,0]$	(4) $\bar{x},y,z [0,0,0]$
	1 a $m..1'$	$0,y,z [0,0,0]$

Symmetry of special projections

Along $[001]$ $2mm1'$	Along $[100]$ $p11g1'$	Along $[010]$ $p11m1'$
Origin at $0,0,z$	$a^* = c$ Origin at $x,0,0$	$a^* = c/2$ Origin at $0,y,0$

$pm'c'2_1$

$m'm'2$

Orthorhombic

No. 17.3.79

$pm'c'2_1$

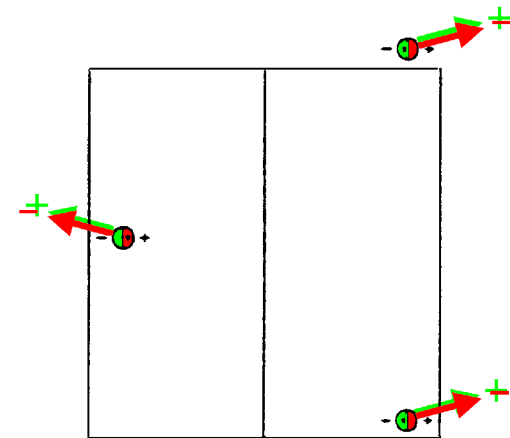
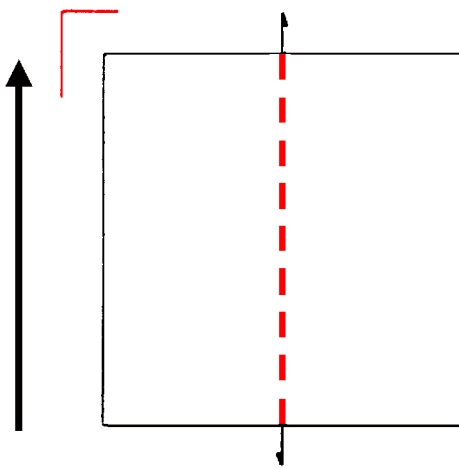
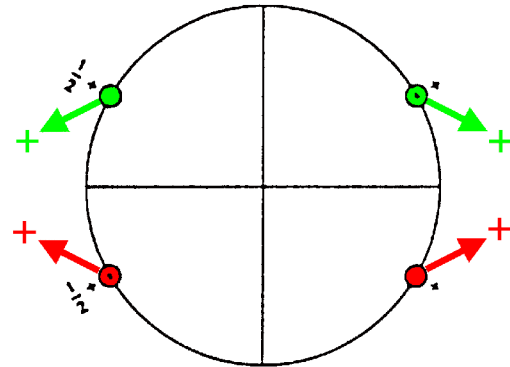
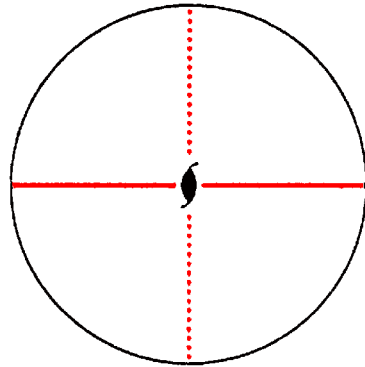

Origin on $m'c'2_1$

Asymmetric unit $0 \leq x; 0 \leq y; 0 \leq z \leq 1$

Symmetry operations

- (1) 1 (1|0,0,0) (2) 2 (0,0,1/2) 0,0,z (2_z|0,0,1/2) (3) c' (0,0,1/2) x,0,z (m_y|0,0,1/2)' (4) m' 0,y,z (m_x|0,0,0)'

Generators selected (1); $t(0,0,1)$; (2); (3)

Positions

Multiplicity, Wyckoff letter, Site symmetry	Coordinates	
	(1) x,y,z [u,v,w]	(2) $\bar{x},\bar{y},z+1/2$ [\bar{u},\bar{v},w]
4 b 1	(3) $x,\bar{y},z+1/2$ [u,\bar{v},w]	(4) \bar{x},y,z [\bar{u},v,w]
	1 a $m'..$	$0,y,z$ [u,0,0] $0,\bar{y},z+1/2$ [$\bar{u},0,0$]

Symmetry of special projections

Along [001] $2m'm'$	Along [100] $p11g'$	Along [010] $p11m'$
Origin at 0,0,z	$a^* = c$ Origin at x,0,0	$a^* = c/2$ Origin at 0,y,0

$pm'c2_1'$

No. 17.4.80

$m'm2'$

$pm'c2_1'$

Orthorhombic

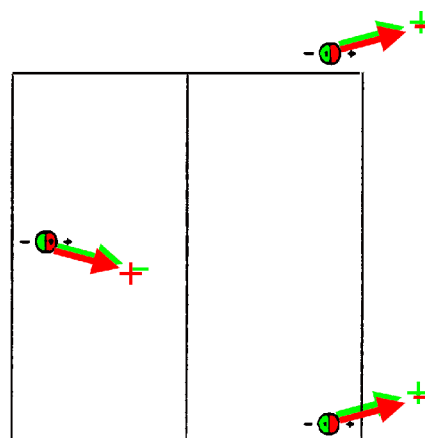
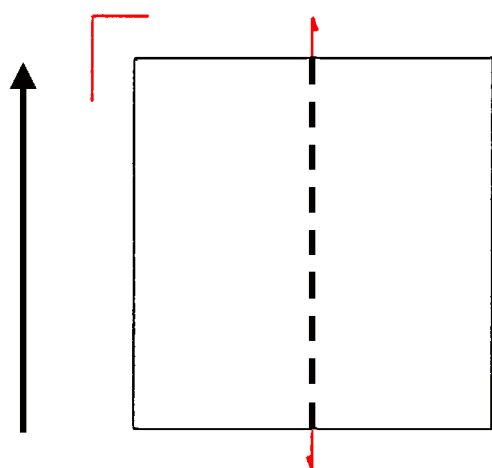
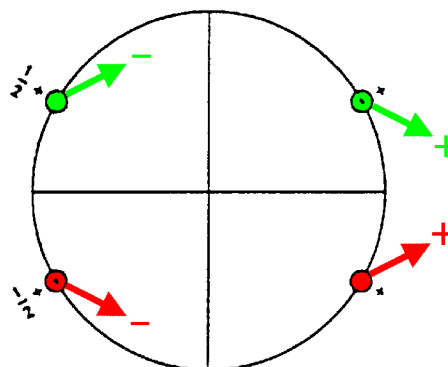
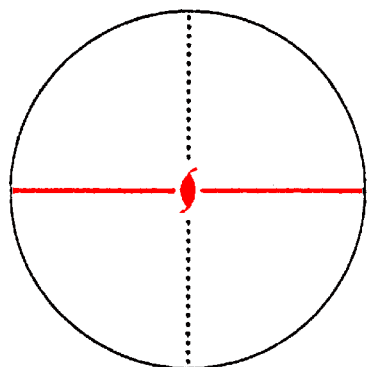

Origin on $m'c2_1'$

Asymmetric unit $0 \leq x; 0 \leq y; 0 \leq z \leq 1$

Symmetry operations

- (1) 1
- (2) $2' (0,0, \frac{1}{2})$ $0,0,z$
- (3) $c (0,0, \frac{1}{2})$ $x,0,z$
- (4) $m' 0,y,z$
- (1|0,0,0)
- (2_z |0,0, $\frac{1}{2}$)'
- (m_y |0,0, $\frac{1}{2}$)
- (m_x |0,0,0)'

Generators selected (1); $t(0,0,1)$; (2); (3)

Positions

	Coordinates	
Multiplicity, Wyckoff letter, Site symmetry		
4 b 1	(1) x,y,z [u,v,w]	(2) $\bar{x},\bar{y},z+1/2$ [u,v, \bar{w}]
	(3) $x,\bar{y},z+1/2$ [\bar{u} ,v, \bar{w}]	(4) \bar{x},y,z [\bar{u} ,v,w]
	1 a $m'..$	$0,y,z$ [0,v,w]
		$0,\bar{y},z+1/2$ [0,v, \bar{w}]

Symmetry of special projections

Along [001] $2mm$	Along [100] $p11g1'$ $a^* = c$	Along [010] $p_{2a^*}11m$ $a^* = c/2$
Origin at 0,0,z	Origin at x,0,0	Origin at 0,y,0

$pmc'2_1'$

No. 17.5.81

$mm'2'$

$pmc'2_1'$

Orthorhombic

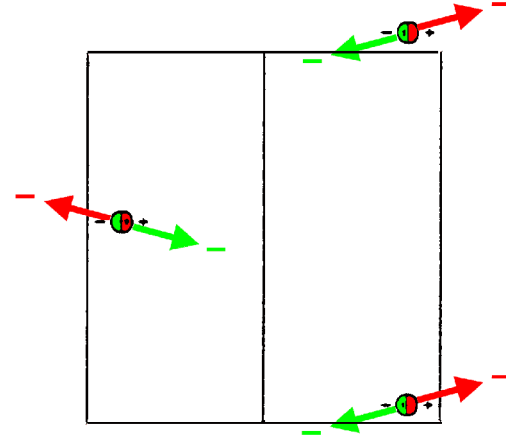
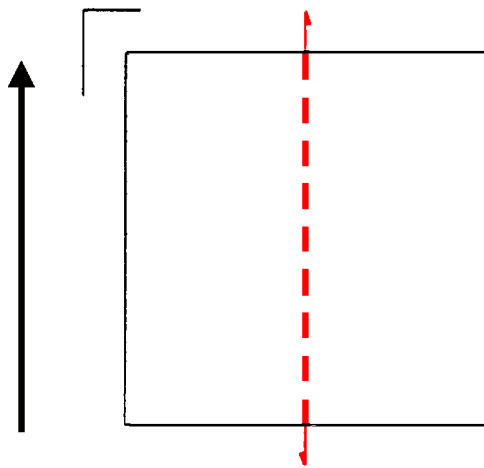
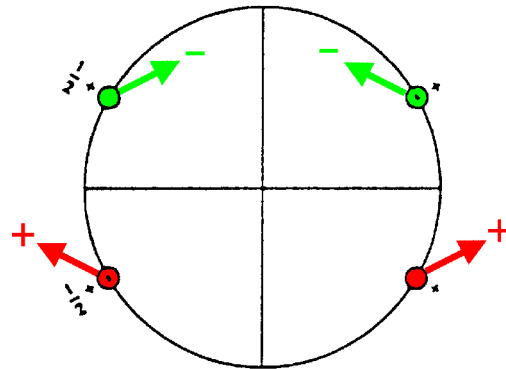
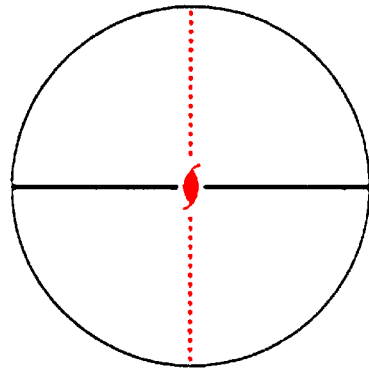

Origin on $mc'2_1'$

Asymmetric unit $0 \leq x$; $0 \leq y$; $0 \leq z \leq 1$

Symmetry operations

- (1) 1 (1|0,0,0) (2) 2 (0,0,1/2) 0,0,z (2_z|0,0,1/2)'
- (3) c' (0,0,1/2) x,0,z (m_y|0,0,1/2)' (4) m 0,y,z (m_x|0,0,0)

Generators selected (1); $t(0,0,1)$; (2); (3)

Positions

	Coordinates	
Multiplicity, Wyckoff letter, Site symmetry		
4 b 1	(1) $x,y,z [u,v,w]$	(2) $\bar{x},\bar{y},z+1/2 [u,v,\bar{w}]$
	(3) $x,\bar{y},z+1/2 [u,\bar{v},w]$	(4) $\bar{x},y,z [u,\bar{v},\bar{w}]$
1 a m..	$0,y,z [u,0,0]$	$0,\bar{y},z+1/2 [u,0,0]$

Symmetry of special projections

Along [001] $2'mm'$	Along [100] $p11g1'$	Along [010] $p11m$
	$a^* = c$	$a^* = c/2$
Origin at $0,0,z$	Origin at $x,0,0$	Origin at $0,y,0$

$p2mm$

No. 18.1.82

$2mm$

$p2mm$

Orthorhombic

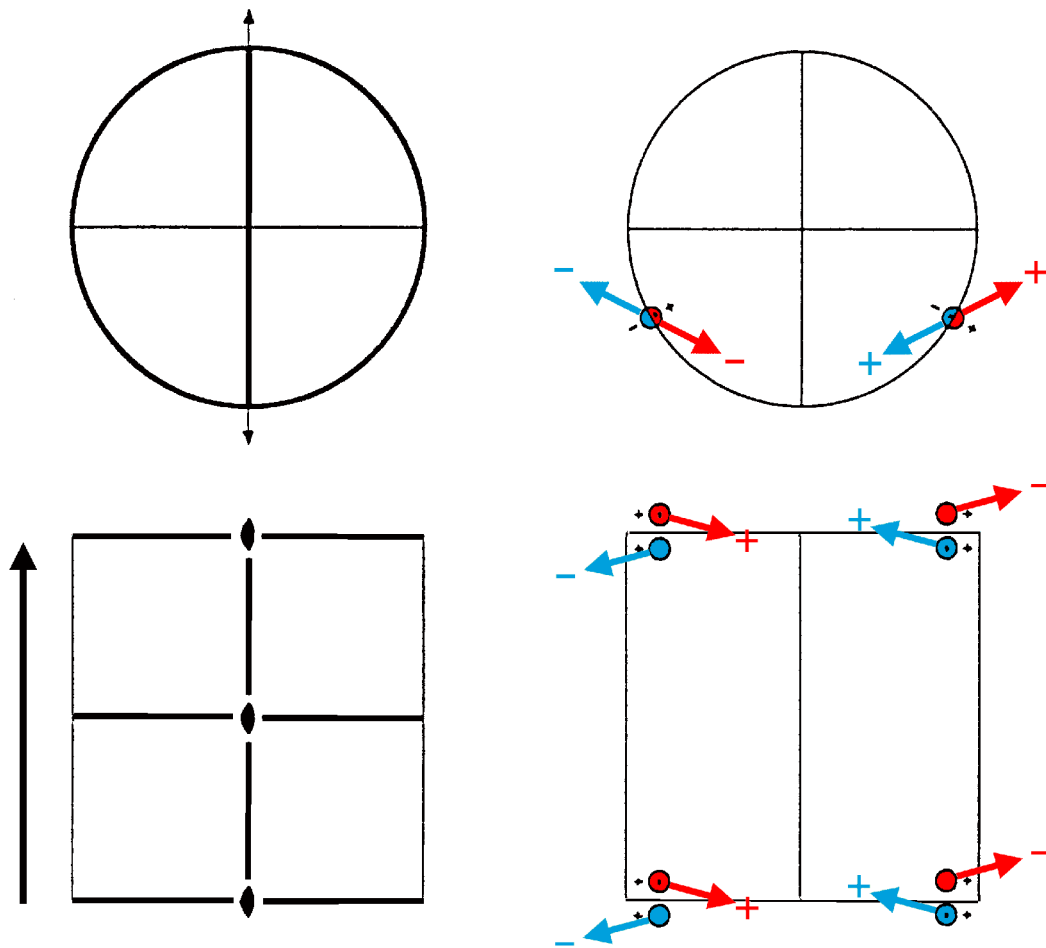

Origin on $2mm$

Asymmetric unit $0 \leq y; 0 \leq z \leq 1/2$

Symmetry operations

- (1) 1
(1|0,0,0)
- (2) 2 $x,0,0$
(2_x |0,0,0)
- (3) m $x,y,0$
(m_z |0,0,0)
- (4) m $x,0,z$
(m_y |0,0,0)

Generators selected (1); $t(0,0,1)$; (2); (3)

Positions

Multiplicity, Wyckoff letter, Site symmetry	Coordinates			
	(1) x,y,z [u,v,w]	(2) x,\bar{y},\bar{z} [u,\bar{v},\bar{w}]	(3) x,y,\bar{z} [\bar{u},\bar{v},w]	(4) x,\bar{y},z [\bar{u},v,\bar{w}]
4 f 1	$(1) x,y,z$ [u,v,w]	$(2) x,\bar{y},\bar{z}$ [u,\bar{v},\bar{w}]	$(3) x,y,\bar{z}$ [\bar{u},\bar{v},w]	$(4) x,\bar{y},z$ [\bar{u},v,\bar{w}]
2 e .m.	$x,0,z$ [$0,v,0$]	$x,0,\bar{z}$ [$0,\bar{v},0$]		
2 d ..m	$x,y,1/2$ [$0,0,w$]	$x,\bar{y},1/2$ [$0,0,\bar{w}$]		
2 c ..m	$x,y,0$ [$0,0,w$]	$x,\bar{y},0$ [$0,0,\bar{w}$]		
1 b 2mm	$x,0,1/2$ [$0,0,0$]			
1 a 2mm	$x,0,0$ [$0,0,0$]			

Symmetry of special projections

Along [001] $11m1'$	Along [100] $p2mm$	Along [010] $p1m1'$
Origin at $0,0,z$	$a^* = c$ Origin at $x,0,0$	$a^* = c$ Origin at $0,y,0$

$p2mm1'$

No. 18.2.83

$2mm1'$

$p2mm1'$

Orthorhombic

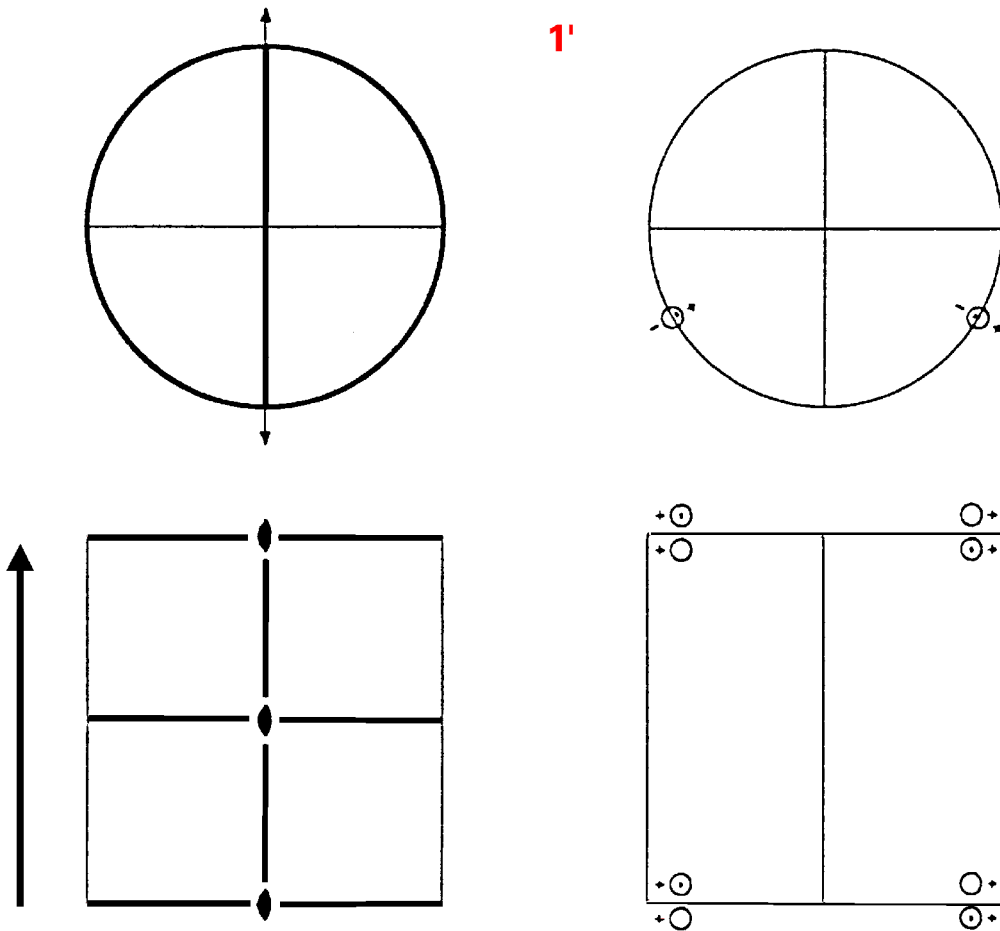

Origin on $2mm1'$

Asymmetric unit $0 \leq y; 0 \leq z \leq 1/2$

Symmetry operations

For $1 +$ set

(1) 1	(2) $2 \quad x,0,0$	(3) $m \quad x,y,0$	(4) $m \quad x,0,z$
$(1 0,0,0)$	$(2_x 0,0,0)$	$(m_z 0,0,0)$	$(m_y 0,0,0)$

For $1' +$ set

(1) $1'$	(2) $2' \quad x,0,0$	(3) $m' \quad x,y,0$	(4) $m' \quad x,0,z$
$(1 0,0,0)'$	$(2_x 0,0,0)'$	$(m_z 0,0,0)'$	$(m_y 0,0,0)'$

Generators selected (1); $t(0,0,1)$; (2); (3); $1'$

Positions

Multiplicity, Wyckoff letter, Site symmetry	Coordinates			
		$1+$	$1' +$	
4 f $11'$	(1) $x,y,z [0,0,0]$	(2) $x,\bar{y},\bar{z} [0,0,0]$	(3) $x,y,\bar{z} [0,0,0]$	(4) $x,\bar{y},z [0,0,0]$
2 e $.m.1'$	$x,0,z [0,0,0]$	$x,0,\bar{z} [0,0,0]$		
2 d $..m1'$	$x,y,1/2 [0,0,0]$	$x,\bar{y},1/2 [0,0,0]$		
2 c $..m1'$	$x,y,0 [0,0,0] [0,0,0]$	$x,\bar{y},0 [0,0,0]$		
1 b $2mm1'$	$x,0,1/2 [0,0,0]$			
1 a $2mm1'$	$x,0,0 [0,0,0]$			

Symmetry of special projections

Along [001] $11m1'$	Along [100] $p2mm1'$	Along [010] $p1m11'$
Origin at $0,0,z$	$a^* = c$ Origin at $x,0,0$	$a^* = c$ Origin at $0,y,0$

$p2m'm'$

No. 18.3.84

$2m'm'$

$p2m'm'$

Orthorhombic

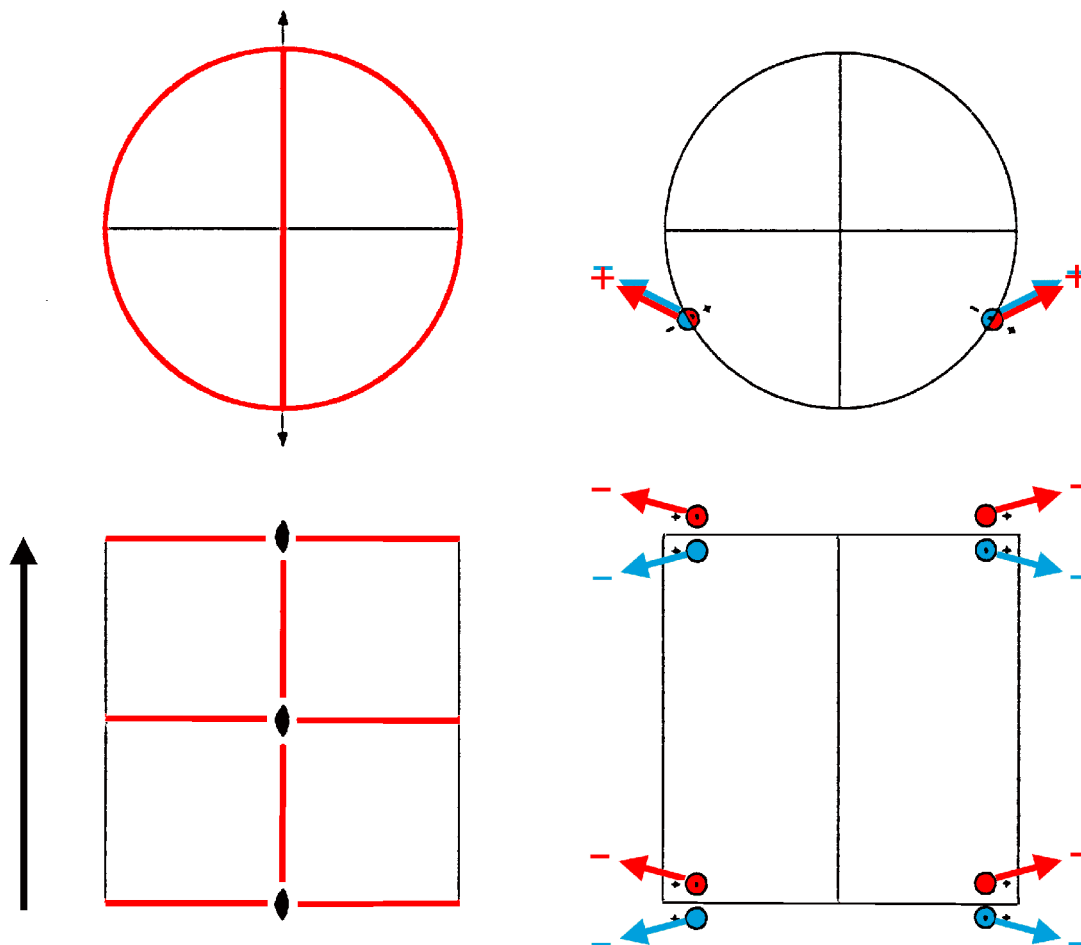

Origin on $2m'm'$

Asymmetric unit $0 \leq y; 0 \leq z \leq 1/2$

Symmetry operations

- (1) 1 (1|0,0,0) (2) 2 $x,0,0$ ($2_x|0,0,0$) (3) m' $x,y,0$ ($m_z|0,0,0$) (4) m' $x,0,z$ ($m_y|0,0,0$)

Generators selected (1); $t(0,0,1)$; (2); (3)

Positions

		Coordinates			
Multiplicity, Wyckoff letter, Site symmetry					
4 f 1	(1) x,y,z [u,v,w]	(2) x,\bar{y},\bar{z} [u, \bar{v} , \bar{w}]	(3) x,y,\bar{z} [u,v, \bar{w}]	(4) x,\bar{y},z [u, \bar{v} ,w]	
2 e $.m'$	$x,0,z$ [u,0,w]	$x,0,\bar{z}$ [u,0, \bar{w}]			
2 d $.m'$	$x,y,1/2$ [u,v,0]	$x,\bar{y},1/2$ [u, \bar{v} ,0]			
2 c $.m'$	$x,y,0$ [u,v,0]	$x,\bar{y},0$ [u, \bar{v} ,0]			
1 b $2m'm'$	$x,0,1/2$ [u,0,0]				
1 a $2m'm'$	$x,0,0$ [u,0,0]				

Symmetry of special projections

Along [001] $11m'$	Along [100] $p2m'm'$	Along [010] $p1m'1$
Origin at 0,0,z	$a^* = c$ Origin at x,0,0	$a^* = c$ Origin at 0,y,0

$p2'm'm$

No. 18.4.85

$2'm'm$

$p2'm'm$

Orthorhombic

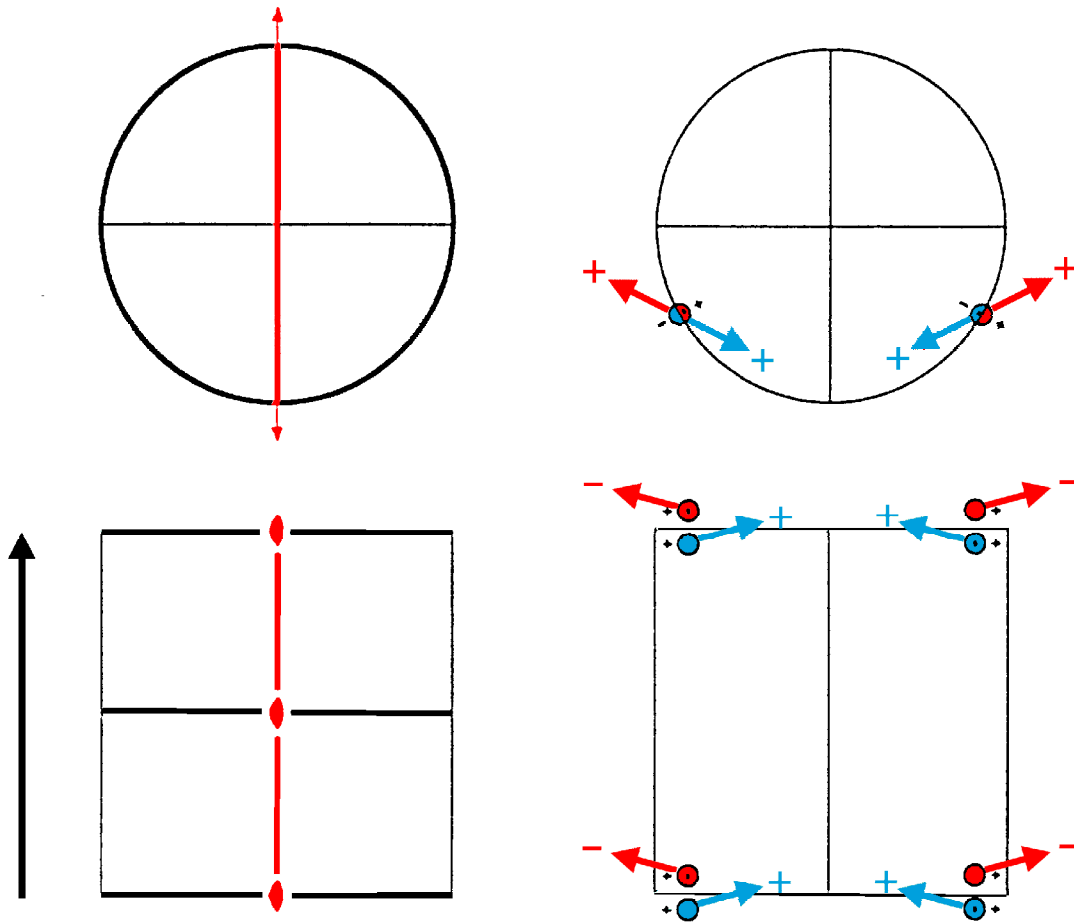

Origin on $2'm'm$

Asymmetric unit $0 \leq y; 0 \leq z \leq 1/2$

Symmetry operations

- (1) 1
(1|0,0,0)
- (2) $2'_x$ x,0,0
(2_x |0,0,0)'
- (3) m x,y,0
(m_z |0,0,0)
- (4) m'_x x,0,z
(m_y |0,0,0)'

Generators selected (1); $t(0,0,1)$; (2); (3)

Positions

Multiplicity, Wyckoff letter, Site symmetry	Coordinates			
	(1) x,y,z [u,v,w]	(2) x,\bar{y},\bar{z} [\bar{u},v,w]	(3) x,y,\bar{z} [\bar{u},\bar{v},w]	(4) x,\bar{y},z [u,\bar{v},w]
4 f 1	(1) x,y,z [u,v,w]	(2) x,\bar{y},\bar{z} [\bar{u},v,w]	(3) x,y,\bar{z} [\bar{u},\bar{v},w]	(4) x,\bar{y},z [u,\bar{v},w]
2 e .m'	$x,0,z$ [$u,0,w$]	$x,0,\bar{z}$ [$\bar{u},0,w$]		
2 d ..m	$x,y,1/2$ [$0,0,w$]	$x,\bar{y},1/2$ [$0,0,w$]		
2 c ..m	$x,y,0$ [$0,0,w$]	$x,\bar{y},0$ [$0,0,w$]		
1 b 2'm'm	$x,0,1/2$ [$0,0,w$]			
1 a 2'm'm	$x,0,0$ [$0,0,w$]			

Symmetry of special projections

Along [001] $11m1'$	Along [100] $p2'mm'$	Along [010] $p1m1$
Origin at $0,0,z$	$a^* = c$ Origin at $x,0,0$	$a^* = c$ Origin at $0,y,0$

$p2'mm'$

No. 18.5.86

$2'mm'$

$p2'mm'$

Orthorhombic

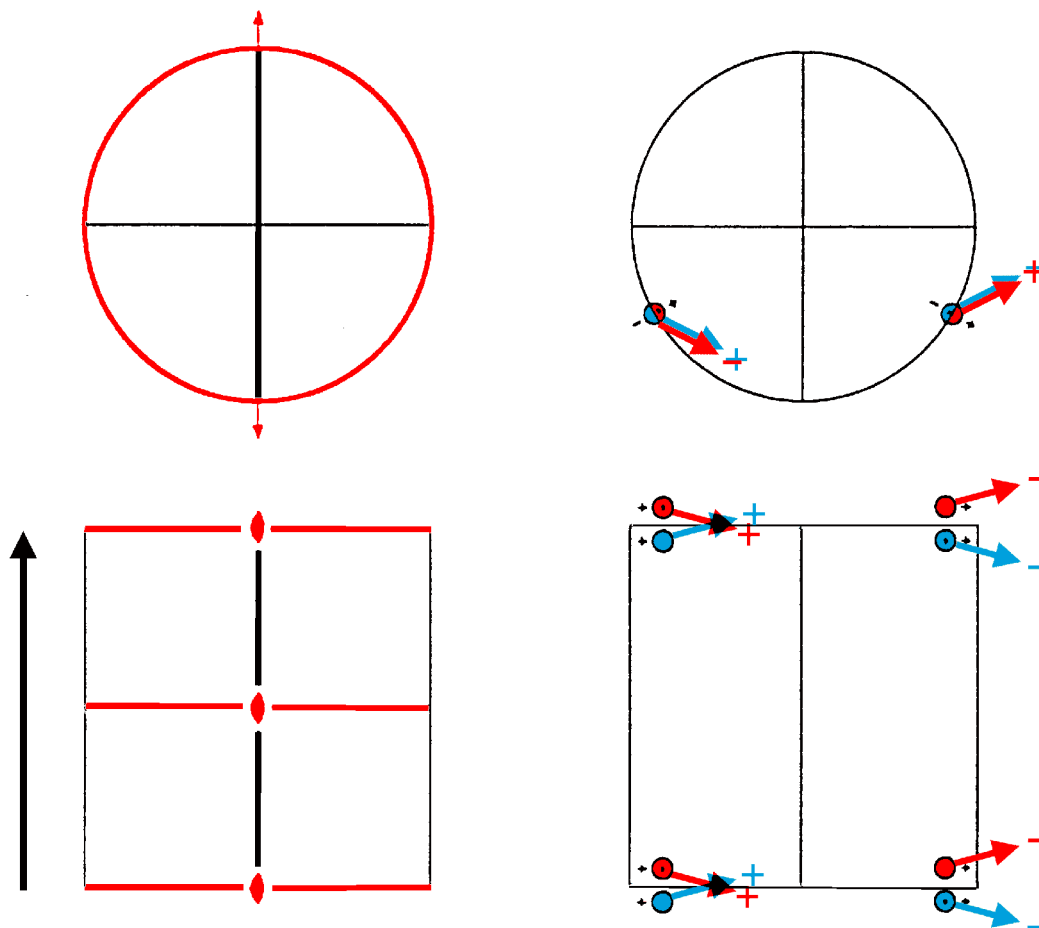

Origin on $2'mm'$

Asymmetric unit $0 \leq y; 0 \leq z \leq 1/2$

Symmetry operations

- (1) 1 (2) $2' \ x,0,0$ (3) $m' \ x,y,0$ (4) $m \ x,0,z$
 (1|0,0,0) (2_x|0,0,0)' (m_z|0,0,0)' (m_y|0,0,0)

Generators selected (1); $t(0,0,1)$; (2); (3)

Positions

Multiplicity, Wyckoff letter, Site symmetry	Coordinates			
	(1) x,y,z [u,v,w]	(2) x,\bar{y},\bar{z} [\bar{u} ,v,w]	(3) x,y,\bar{z} [u,v, \bar{w}]	(4) x,\bar{y},z [\bar{u} ,v, \bar{w}]
4 f 1	(1) x,y,z [u,v,w]	(2) x,\bar{y},\bar{z} [\bar{u} ,v,w]	(3) x,y,\bar{z} [u,v, \bar{w}]	(4) x,\bar{y},z [\bar{u} ,v, \bar{w}]
2 e .m.	$x,0,z$ [0,v,0]	$x,0,\bar{z}$ [0,v,0]		
2 d ..m'	$x,y,1/2$ [u,v,0]	$x,\bar{y},1/2$ [\bar{u} ,v,0]		
2 c ..m'	$x,y,0$ [u,v,0]	$x,\bar{y},0$ [\bar{u} ,v,0]		
1 b 2'mm'	$x,0,1/2$ [0,v,0]			
1 a 2'mm'	$x,0,0$ [0,v,0]			

Symmetry of special projections

Along [001] 11m	Along [100] $p2'm'm$ $a^* = c$	Along [010] $p1m11'$ $a^* = c$
Origin at 0,0,z	Origin at x,0,0	Origin at 0,y,0

$\rho_{2c}2m'm'$

No. 18.6.87

$2mm1'$

$\rho_{2c}2m'm'$

Orthorhombic

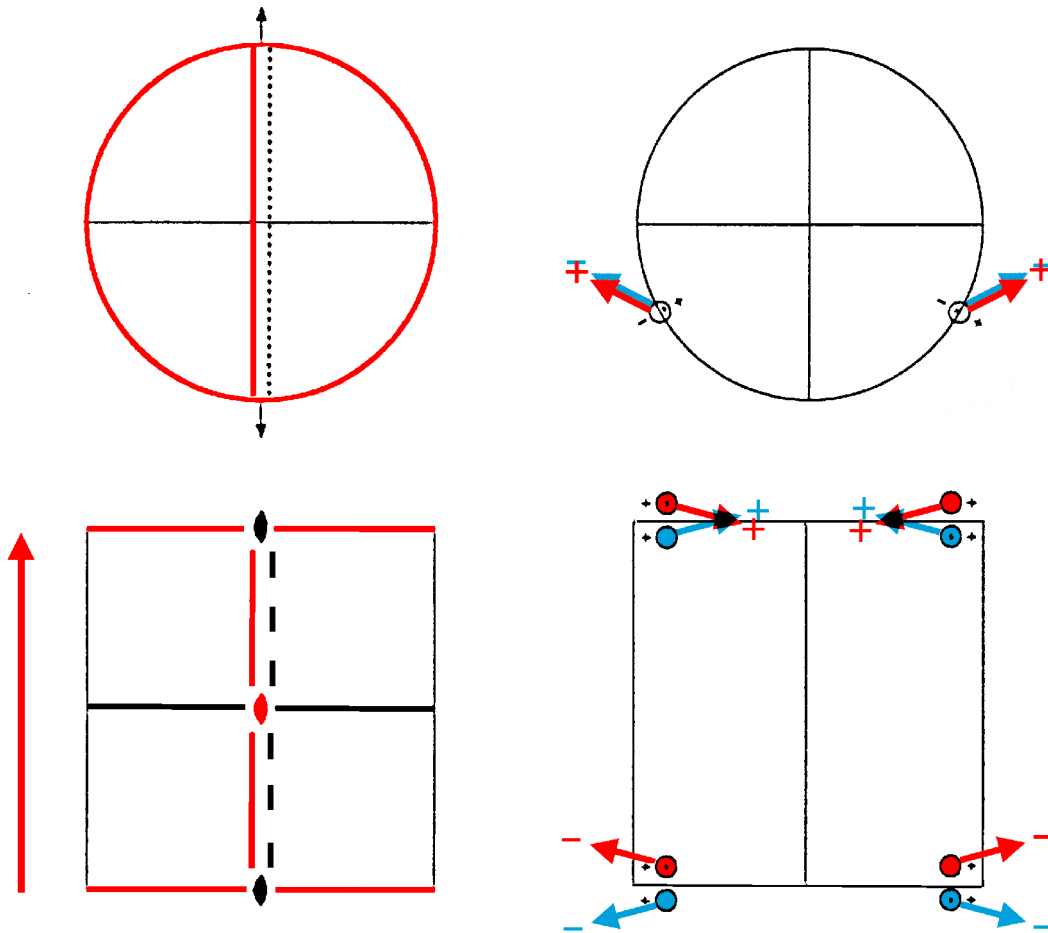

Origin on $2m'm'$

Asymmetric unit $0 \leq y$; $0 \leq z \leq 1/2$

Symmetry operations

For $(0,0,0)$ + set

(1) 1	(2) 2_x $x,0,0$	(3) m'_z $x,y,0$	(4) m'_y $x,0,z$
(1 $0,0,0$)	(2 $_x$ $0,0,0$)	(m'_z $0,0,0$)'	(m'_y $0,0,0$)'

For $(0,0,1)'$ + set

(1) t' $(0,0,1)$	(2) $2'_x$ $x,0,1/2$	(3) m_x $x,y,1/2$	(4) c $(0,0,1)$ $x,0,z$
(1 $0,0,1$)'	(2 $_x$ $0,0,1$)'	(m_x $0,0,1$)	(m_y $0,0,1$)

Generators selected (1); $t(0,0,1)'$; (2); (3)

Positions

Multiplicity, Wyckoff letter, Site symmetry	Coordinates			
		$(0,0,0)_+$	$(0,0,1)'$	+
4 f 1	(1) $x,y,z [u,v,w]$	(2) $x,\bar{y},\bar{z} [u,\bar{v},\bar{w}]$	(3) $x,y,\bar{z} [u,v,\bar{w}]$	(4) $x,\bar{y},z [u,\bar{v},w]$
2 e $..m'$	$x,0,z [u,0,w]$	$x,0,\bar{z} [u,0,\bar{w}]$		
2 d $..m$	$x,y,1/2 [0,0,w]$	$x,\bar{y},1/2 [0,0,w]$		
2 c $..m'$	$x,y,0 [u,v,0]$	$x,\bar{y},0 [u,\bar{v},0]$		
1 b $2'm'm$	$x,0,1/2 [0,0,w]$			
1 a $2m'm'$	$x,0,0 [u,0,0]$			

Symmetry of special projections

Along [001] $11m1'$	Along [100] $p_{2a^*}2m'm'$	Along [010] $p_{2a^*}1m'1$
Origin at $0,0,z$	$a^* = c$ Origin at $x,0,0$	$a^* = c$ Origin at $0,y,0$

$p_{2c}2mm$

No. 18.7.88

$2mm1'$

$p_{2c}2mm$

Orthorhombic

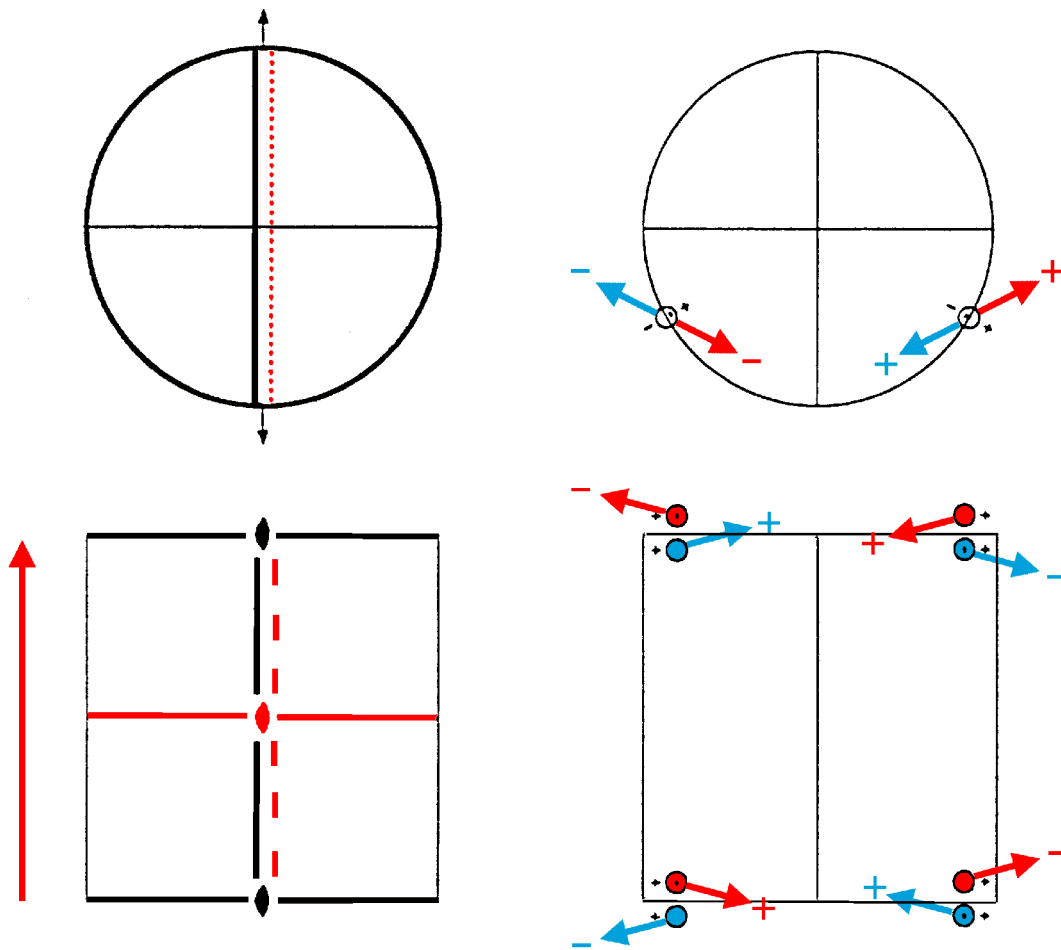

Origin on $2mm$

Asymmetric unit $0 \leq y; 0 \leq z \leq 1/2$

Symmetry operations

For $(0,0,0)$ + set

(1) 1	(2) 2_x $x,0,0$	(3) m $x,y,0$	(4) m $x,0,z$
$(1 0,0,0)$	$(2_x 0,0,0)$	$(m_z 0,0,0)$	$(m_y 0,0,0)$

For $(0,0,1)'$ + set

(1) t' $(0,0,1)$	(2) $2'_x$ $x,0,1/2$	(3) m' $x,y,1/2$	(4) c' $(0,0,1)$ $x,0,z$
$(1 0,0,1)'$	$(2'_x 0,0,1)'$	$(m'_z 0,0,1)'$	$(m'_y 0,0,1)'$

Generators selected (1); $t(0,0,1)'$; (2); (3)

Positions

Multiplicity, Wyckoff letter, Site symmetry	Coordinates			
		$(0,0,0)_+$	$(0,0,1)'$ +	
4 f 1	(1) $x,y,z [u,v,w]$	(2) $x,\bar{y},\bar{z} [u,\bar{v},\bar{w}]$	(3) $x,y,\bar{z} [\bar{u},\bar{v},w]$	(4) $x,\bar{y},z [\bar{u},v,\bar{w}]$
2 e .m	$x,0,z [0,v,0]$	$x,0,\bar{z} [0,\bar{v},0]$		
2 d ..m'	$x,y,1/2 [u,v,0]$	$x,\bar{y},1/2 [\bar{u},v,0]$		
2 c ..m	$x,y,0 [0,0,w]$	$x,\bar{y},0 [0,0,\bar{w}]$		
1 b 2'mm'	$x,0,1/2 [0,v,0]$			
1 a 2mm	$x,0,0 [0,0,0]$			

Symmetry of special projections

Along [001] $11m1'$	Along [100] $p_{2a^*}2mm$	Along [010] $p1m11'$
Origin at $0,0,z$	$a^* = c$ Origin at $x,0,0$	$a^* = c$ Origin at $0,y,0$

$p2cm$

$2mm$

Orthorhombic

No. 19.1.89

$p2cm$

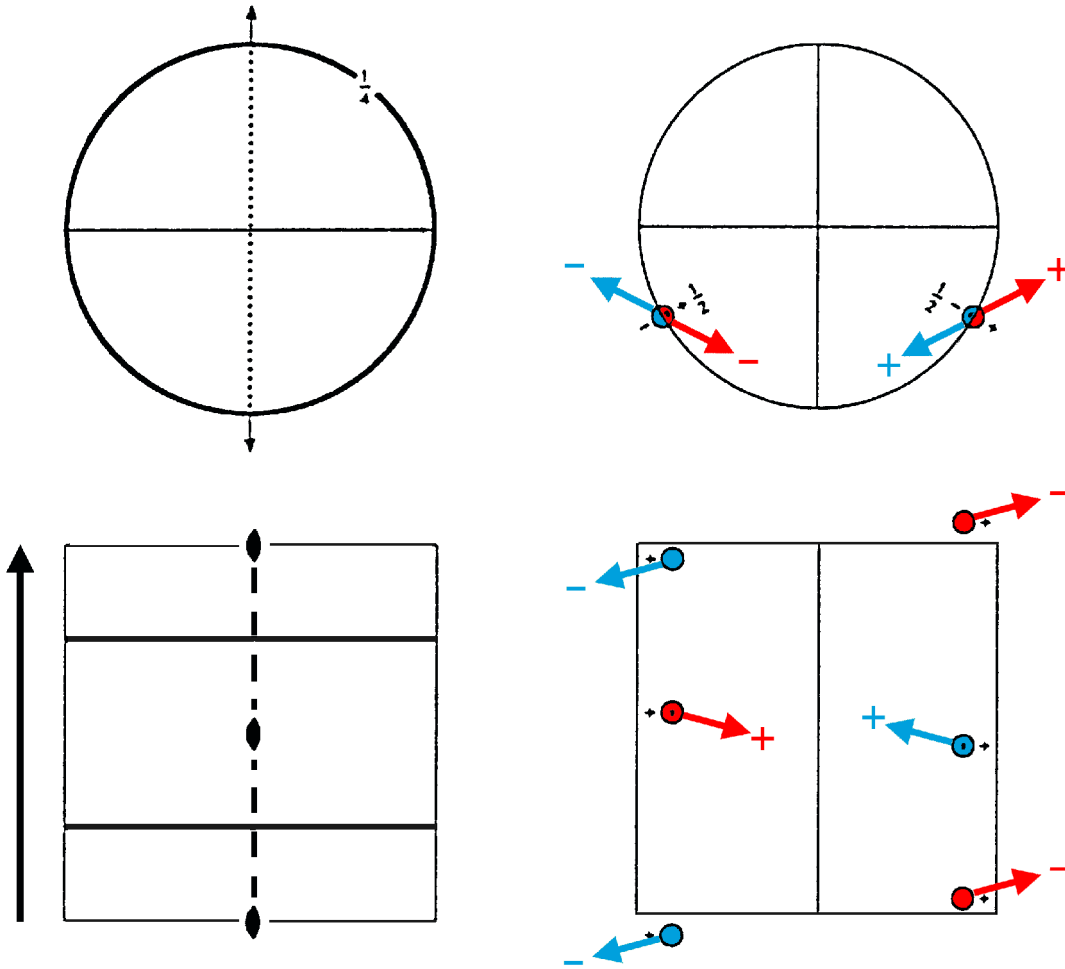

Origin on $2c1$

Asymmetric unit $0 \leq z \leq 1/4$

Symmetry operations

- | | | | |
|--------------------|----------------------------------|--|--------------------------------------|
| (1) 1
(1 0,0,0) | (2) 2 $x,0,0$
(2_x 0,0,0) | (3) c $(0,0,1/2)$ $x,0,z$
(m_y 0,0,1/2) | (4) m $x,y,1/4$
(m_z 0,0,1/2) |
|--------------------|----------------------------------|--|--------------------------------------|

Generators selected (1); $t(0,0,1)$; (2); (3)

Positions

Multiplicity, Wyckoff letter, Site symmetry	Coordinates	
	(1) x,y,z [u,v,w]	(2) x,\bar{y},\bar{z} [u, \bar{v} , \bar{w}]
4 c 1	(3) $x,\bar{y},z+1/2$ [\bar{u} ,v, \bar{w}]	(4) $x,y,\bar{z}+1/2$ [\bar{u} , \bar{v} ,w]
2 b ..m	$x,y,1/4$ [0,0,w]	$x,\bar{y},3/4$ [0,0, \bar{w}]
2 a 2..	$x,0,0$ [u,0,0]	$x,0,1/2$ [\bar{u} ,0,0]

Symmetry of special projections

Along [001] $11m1'$	Along [100] $p2mg$ $a^* = c$	Along [010] $p_{2a^*}1m1$ $a^* = c/2$
Origin at 0,0,z	Origin at x,0,0	Origin at 0,y,0

$p2cm1'$

No. 19.2.90

$2mm1'$

$p2cm1'$

Orthorhombic

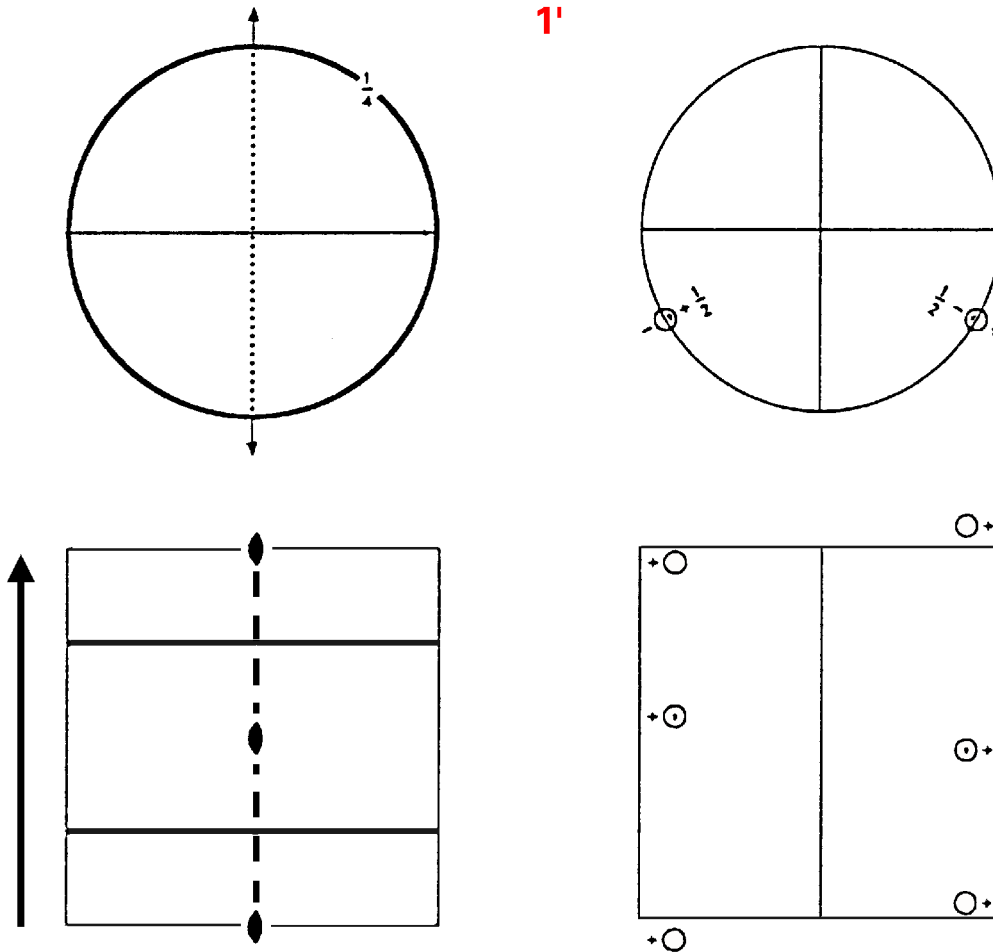

Origin on $2c11'$

Asymmetric unit $0 \leq z \leq 1/4$

Symmetry operations

For 1 + set

(1) 1	(2) $2 \ x,0,0$	(3) $c \ (0,0,1/2) \ x,0,z$	(4) $m \ x,y,1/4$
(1 0,0,0)	(2_x 0,0,0)	(m_y 0,0,1/2)	(m_z 0,0,1/2)

For 1' + set

(1) 1'	(2) $2' \ x,0,0$	(3) $c' \ (0,0,1/2) \ x,0,z$	(4) $m' \ x,y,1/4$
(1 0,0,0)'	(2_x 0,0,0)'	(m_y 0,0,1/2)'	(m_z 0,0,1/2)'

Generators selected (1); $t(0,0,1)$; (2); (3); $1'$

Positions

Multiplicity, Wyckoff letter, Site symmetry	Coordinates	
		1+ 1' +
4 c 11'	(1) x,y,z [0,0,0]	(2) x,\bar{y},\bar{z} [0,0,0]
	(3) $x,\bar{y},z+1/2$ [0,0,0]	(4) $x,y,\bar{z}+1/2$ [0,0,0]
2 b ..m1'	$x,y,1/4$ [0,0,0]	$x,\bar{y},3/4$ [0,0,0]
2 a 2..1'	$x,0,0$ [0,0,0]	$x,0,1/2$ [0,0,0]

Symmetry of special projections

Along [001] $11m1'$	Along [100] $p2mg1'$	Along [010] $p1m11'$
Origin at 0,0,z	$a^* = c$ Origin at $x,0,0$	$a^* = c/2$ Origin at 0,y,0

$p2c'm'$

No. 19.3.91

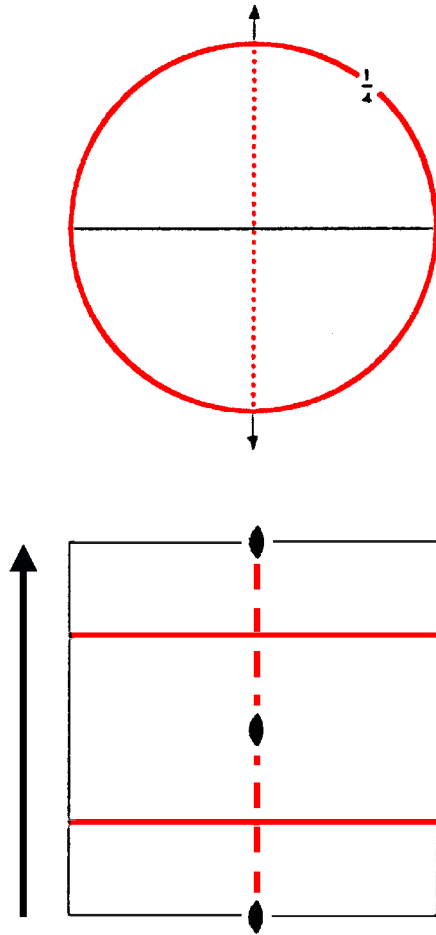

$2m'm'$

$p2c'm'$

Orthorhombic

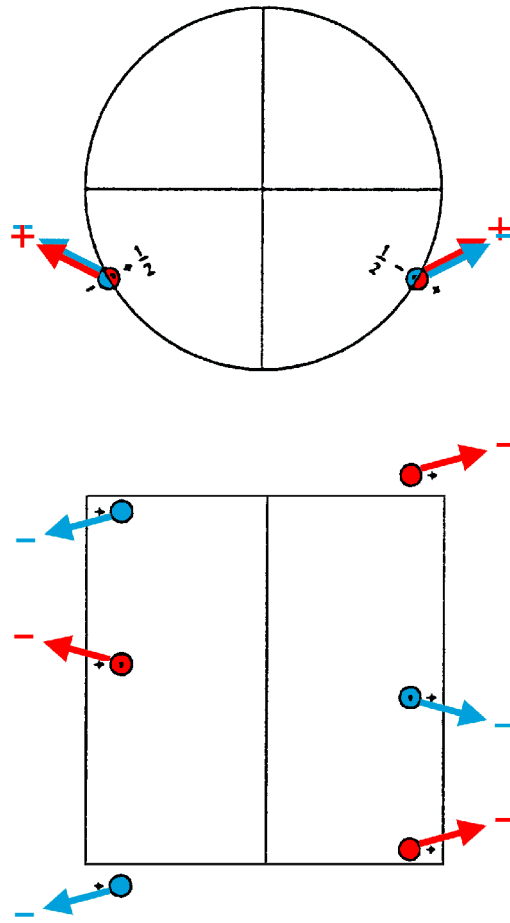

Origin on $2c'$

Asymmetric unit $0 \leq z \leq 1/4$

Symmetry operations

- (1) 1
(1|0,0,0)
- (2) 2_x x,0,0
(2_x |0,0,0)
- (3) c' (0,0,1/2) x,0,z
(m_y |0,0,1/2)'
- (4) m' x,y,1/4
(m_z |0,0,1/2)'

Generators selected (1); $t(0,0,1)$; (2); (3)

Positions

	Coordinates	
Multiplicity, Wyckoff letter, Site symmetry		
4 c 1	(1) x,y,z [u,v,w]	(2) x,\bar{y},\bar{z} [u, \bar{v} , \bar{w}]
	(3) $x,\bar{y},z+1/2$ [u, \bar{v} ,w]	(4) $x,y,\bar{z}+1/2$ [u,v, \bar{w}]
2 b ..m'	$x,y,1/4$ [u,v,0]	$x,\bar{y},3/4$ [u, \bar{v} ,0]
2 a 2..	$x,0,0$ [u,0,0]	$x,0,1/2$ [u,0,0]

Symmetry of special projections

Along [001] $11m'$	Along [100] $p2m'g'$	Along [010] $p1m'1$
Origin at 0,0,z	$a^* = c$ Origin at x,0,0	$a^* = c/2$ Origin at 0,y,0

$p2'cm'$

No. 19.4.92

$2'mm'$

$p2'cm'$

Orthorhombic

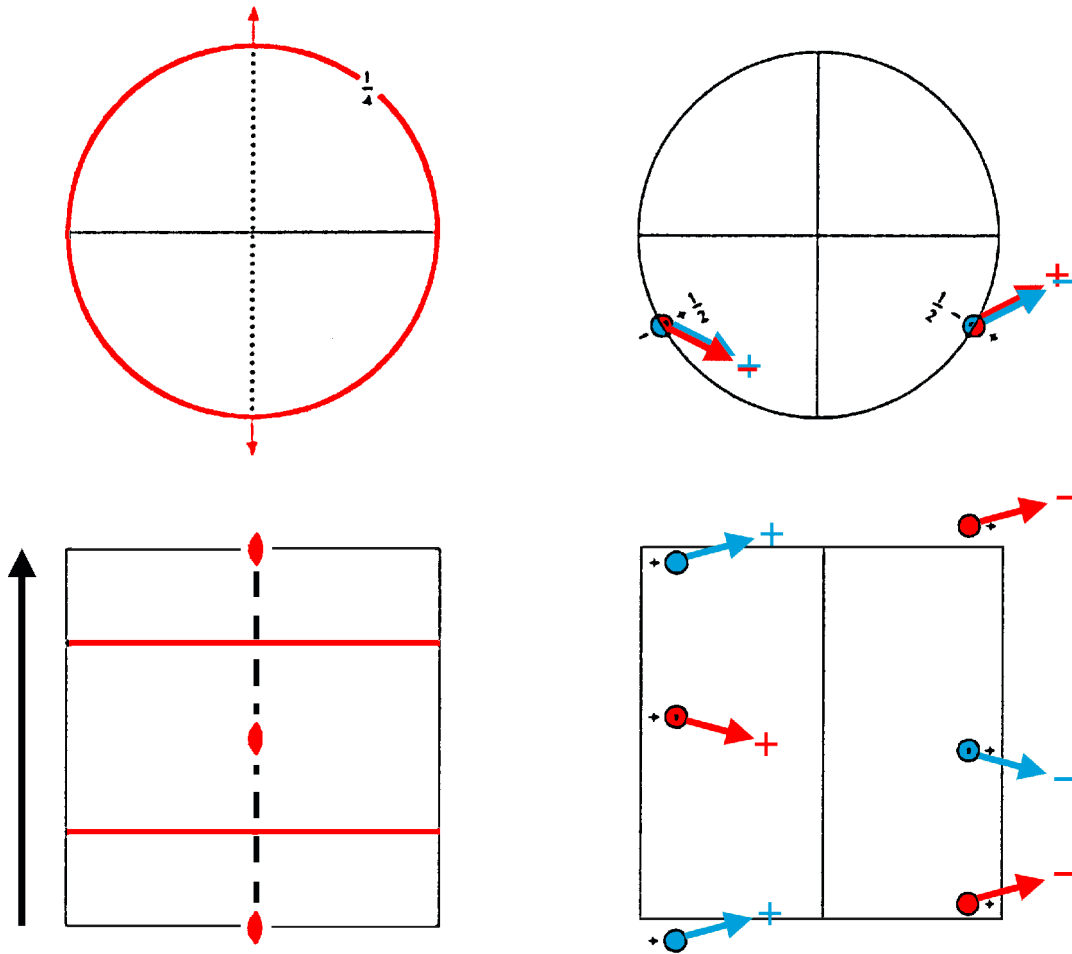

Origin on $2'c1$

Asymmetric unit $0 \leq z \leq 1/4$

Symmetry operations

- (1) 1
(1|0,0,0)
- (2) $2'$ $x,0,0$
(2_x |0,0,0)'
- (3) c $(0,0,1/2)$ $x,0,z$
(m_y |0,0,1/2)
- (4) m' $x,y,1/4$
(m_z |0,0,1/2)'

Generators selected (1); $t(0,0,1)$; (2); (3)

Positions

	Coordinates	
Multiplicity, Wyckoff letter, Site symmetry		
4 c 1	(1) x,y,z [u,v,w]	(2) x,\bar{y},\bar{z} [\bar{u},v,w]
	(3) $x,\bar{y},z+1/2$ [\bar{u},v,\bar{w}]	(4) $x,y,\bar{z}+1/2$ [u,v, \bar{w}]
	2 b ..m'	$x,y,1/4$ [u,v,0] $x,\bar{y},3/4$ [$\bar{u},v,0$]
	2 a 2'..	$x,0,0$ [0,v,w] $x,0,1/2$ [0,v, \bar{w}]

Symmetry of special projections

Along [001] $11m$	Along [100] $p2'm'g$ $a^* = c$	Along [010] $p_{2a^*}1m1$ $a^* = c/2$
Origin at 0,0,z	Origin at x,0,0	Origin at 0,y,0

$p2'c'm$

No. 19.5.93

$2'm'm$

$p2'c'm$

Orthorhombic

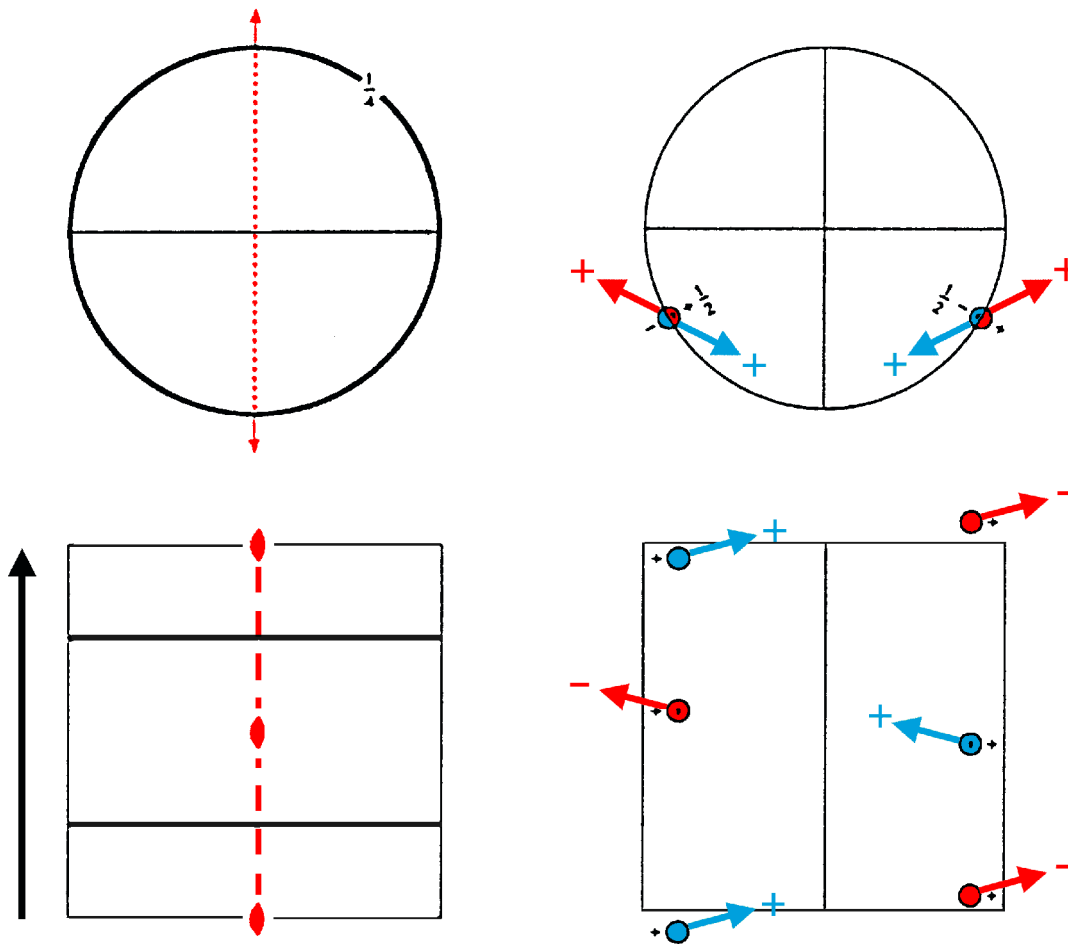

Origin on $2'c'1$

Asymmetric unit $0 \leq z \leq 1/4$

Symmetry operations

- (1) 1 (1|0,0,0) (2) $2'$ $x,0,0$ ($2_x|0,0,0$)' (3) c' $(0,0,1/2)$ $x,0,z$ ($m_y|0,0,1/2$)' (4) m $x,y,1/4$ ($m_z|0,0,1/2$)

Generators selected (1); $t(0,0,1)$; (2); (3)

Positions

Multiplicity, Wyckoff letter, Site symmetry	Coordinates	
	(1) x,y,z [u,v,w]	(2) x,\bar{y},\bar{z} [\bar{u} ,v,w]
4 c 1	(3) $x,\bar{y},z+1/2$ [u, \bar{v} ,w]	(4) $x,y,\bar{z}+1/2$ [\bar{u} , \bar{v} ,w]
2 b ..m	$x,y,1/4$ [0,0,w]	$x,\bar{y},3/4$ [0,0,w]
2 a 2'..	$x,0,0$ [0,v,w]	$x,0,1/2$ [0, \bar{v} ,w]

Symmetry of special projections

Along [001] $11m'$ Origin at 0,0,z	Along [100] $p2'mg'$ $a^* = c$ Origin at x,0,0	Along [010] $p_{2a^*}1m1$ $a^* = c/2$ Origin at 0,y,0
---------------------------------------	--	---

$pmmm$

No. 20.1.94

mmm

$p2/m2/m2/m$

Orthorhombic

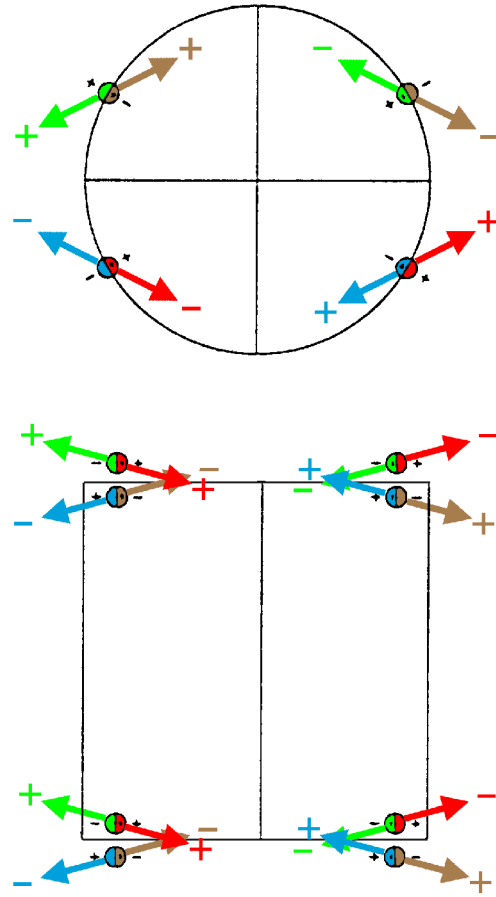
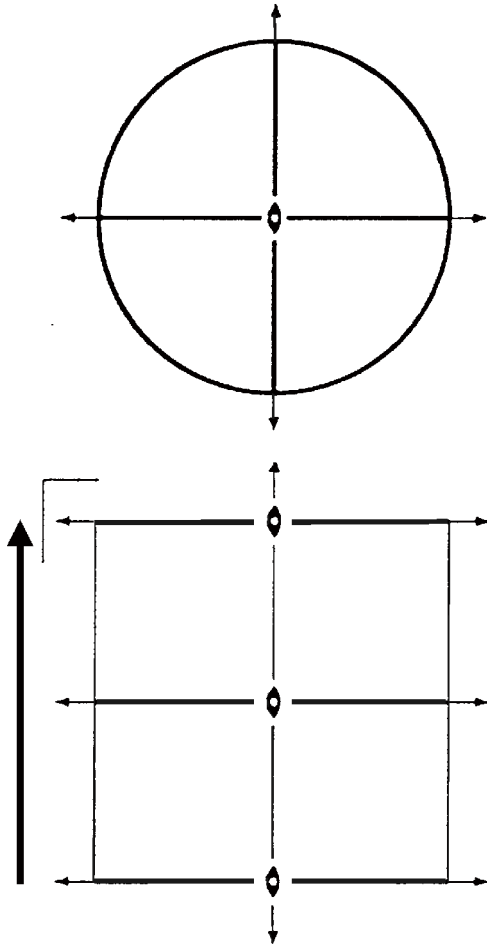

Origin at center (mmm)

Asymmetric unit $0 \leq x; 0 \leq y; 0 \leq z \leq 1/2$

Symmetry operations

(1) 1
(1|0,0,0)

(2) 2 $0,0,z$
(2_z |0,0,0)

(3) 2 $0,y,0$
(2_y |0,0,0)

(4) 2 $x,0,0$
(2_x |0,0,0)

(5) $\bar{1}$ $0,0,0$
($\bar{1}$ |0,0,0)

(6) m $x,y,0$
(m_z |0,0,0)

(7) m $x,0,z$
(m_y |0,0,0)

(8) m $0,y,z$
(m_x |0,0,0)

Generators selected (1); $t(0,0,1)$; (2); (3); (5)

Positions

	Coordinates			
Multiplicity, Wyckoff letter, Site symmetry				
8 l 1	(1) $x,y,z [u,v,w]$	(2) $\bar{x},\bar{y},z [\bar{u},\bar{v},w]$	(3) $\bar{x},y,\bar{z} [\bar{u},v,\bar{w}]$	(4) $x,\bar{y},\bar{z} [u,\bar{v},\bar{w}]$
	(5) $\bar{x},\bar{y},\bar{z} [u,v,w]$	(6) $x,y,\bar{z} [\bar{u},\bar{v},w]$	(7) $x,\bar{y},z [\bar{u},v,\bar{w}]$	(8) $\bar{x},y,z [u,\bar{v},\bar{w}]$
4 k ..m	$x,y,1/2 [0,0,w]$	$\bar{x},\bar{y},1/2 [0,0,w]$	$\bar{x},y,1/2 [0,0,\bar{w}]$	$x,\bar{y},1/2 [0,0,\bar{w}]$
4 j ..m	$x,y,0 [0,0,w]$	$\bar{x},\bar{y},0 [0,0,w]$	$\bar{x},y,0 [0,0,\bar{w}]$	$x,\bar{y},0 [0,0,\bar{w}]$
4 i .m.	$x,0,z [0,v,0]$	$\bar{x},0,z [0,\bar{v},0]$	$\bar{x},0,\bar{z} [0,v,0]$	$x,0,\bar{z} [0,\bar{v},0]$
4 h m..	$0,y,z [u,0,0]$	$0,\bar{y},z [\bar{u},0,0]$	$0,y,\bar{z} [\bar{u},0,0]$	$0,\bar{y},\bar{z} [u,0,0]$
2 g mm2	$0,0,z [0,0,0]$	$0,0,\bar{z} [0,0,0]$		
2 f m2m	$0,y,1/2 [0,0,0]$	$0,\bar{y},1/2 [0,0,0]$		
2 e m2m	$0,y,0 [0,0,0]$	$0,\bar{y},0 [0,0,0]$		
2 d 2mm	$x,0,1/2 [0,0,0]$	$\bar{x},0,1/2 [0,0,0]$		
2 c 2mm	$x,0,0 [0,0,0]$	$\bar{x},0,0 [0,0,0]$		
1 b mmm	$0,0,1/2 [0,0,0]$			
1 a mmm	$0,0,0 [0,0,0]$			

Continued

No. 20.1.94

$pmmm$

Symmetry of special projections

Along $[001]$ $2mm1'$

Origin at $0,0,z$

Along $[100]$ $p2mm1'$

$a^* = c$

Origin at $x,0,0$

Along $[010]$ $p2mm1'$

$a^* = c$

Origin at $0,y,0$

$pmmm1'$

$mmm1'$

Orthorhombic

No. 20.2.95

$p2/m2/m2/m1'$

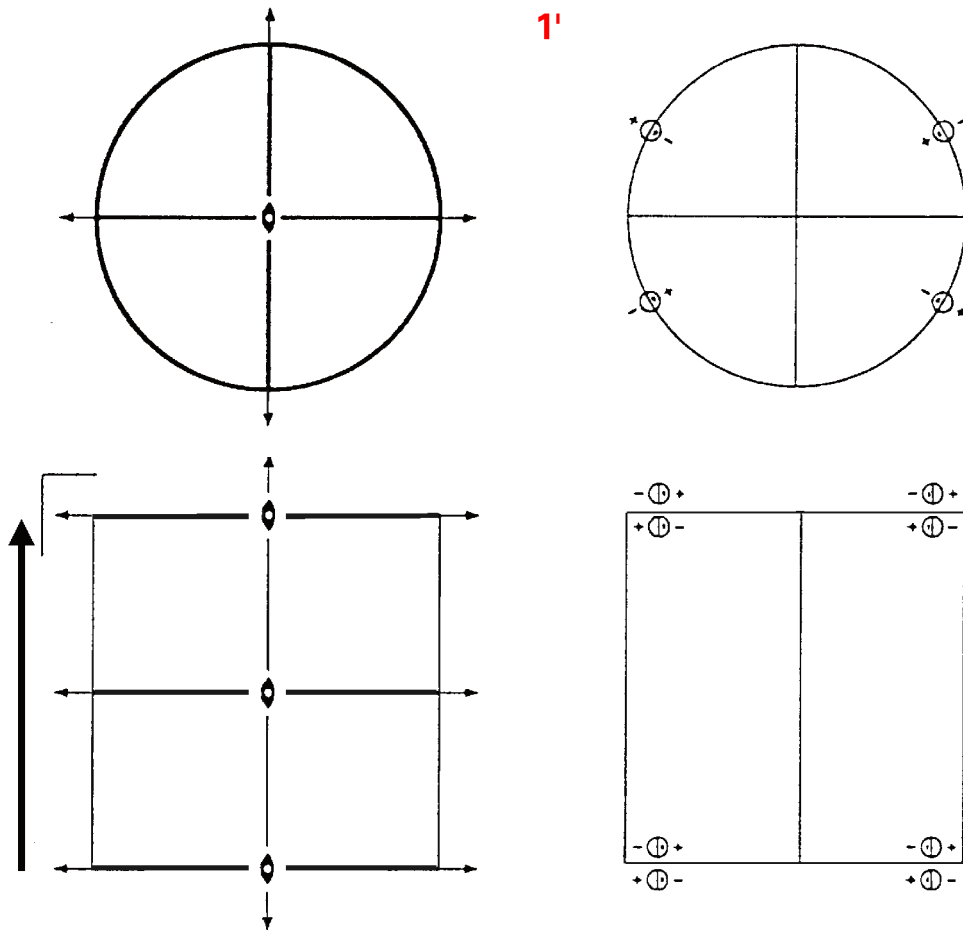

Origin at center ($mmm1'$)

Asymmetric unit $0 \leq x; 0 \leq y; 0 \leq z \leq 1/2$

Symmetry operations

For 1 + set

- | | | | |
|--|--|--|--|
| (1) 1
(1 0,0,0) | (2) 2 0,0,z
(2 _z 0,0,0) | (3) 2 0,y,0
(2 _y 0,0,0) | (4) 2 x,0,0
(2 _x 0,0,0) |
| (5) $\bar{1}$ 0,0,0
($\bar{1}$ 0,0,0) | (6) m x,y,0
(m _z 0,0,0) | (7) m x,0,z
(m _y 0,0,0) | (8) m 0,y,z
(m _x 0,0,0) |

For 1' + set

- | | | | |
|---|--|--|--|
| (1) 1'
(1 0,0,0)' | (2) 2' 0,0,z
(2 _z 0,0,0)' | (3) 2' 0,y,0
(2 _y 0,0,0)' | (4) 2' x,0,0
(2 _x 0,0,0)' |
| (5) $\bar{1}$ ' 0,0,0
($\bar{1}$ 0,0,0)' | (6) m' x,y,0
(m _z 0,0,0)' | (7) m' x,0,z
(m _y 0,0,0)' | (8) m' 0,y,z
(m _x 0,0,0)' |

Generators selected (1); t(0,0,1); (2); (3); (5); 1'

Positions

Multiplicity, Wyckoff letter, Site symmetry	Coordinates			
	1+	1'	+	
8 l 11'	(1) x,y,z [0,0,0]	(2) \bar{x},\bar{y},z [0,0,0]	(3) \bar{x},y,\bar{z} [0,0,0]	(4) x, \bar{y},\bar{z} [0,0,0]
	(5) \bar{x},\bar{y},\bar{z} [0,0,0]	(6) x,y, \bar{z} [0,0,0]	(7) x, \bar{y},z [0,0,0]	(8) \bar{x},y,z [0,0,0]
4 k ..m1'	x,y,1/2 [0,0,0]	$\bar{x},\bar{y},1/2$ [0,0,0]	$\bar{x},y,1/2$ [0,0,0]	x, $\bar{y},1/2$ [0,0,0]
4 j ..m1'	x,y,0 [0,0,0]	$\bar{x},\bar{y},0$ [0,0,0]	$\bar{x},y,0$ [0,0,0]	x, $\bar{y},0$ [0,0,0]
4 i .m.1'	x,0,z [0,0,0]	$\bar{x},0,z$ [0,0,0]	$\bar{x},0,\bar{z}$ [0,0,0]	x,0, \bar{z} [0,0,0]
4 h m..1'	0,y,z [0,0,0]	0, \bar{y},z [0,0,0]	0,y, \bar{z} [0,0,0]	0, \bar{y},\bar{z} [0,0,0]
2 g mm21'	0,0,z [0,0,0]	0,0, \bar{z} [0,0,0]		
2 f m2m1'	0,y,1/2 [0,0,0]	0, $\bar{y},1/2$ [0,0,0]		
2 e m2m1'	0,y,0 [0,0,0]	0, $\bar{y},0$ [0,0,0]		
2 d 2mm1'	x,0,1/2 [0,0,0]	$\bar{x},0,1/2$ [0,0,0]		
2 c 2mm1'	x,0,0 [0,0,0]	$\bar{x},0,0$ [0,0,0]		
1 b mmm1'	0,0,1/2 [0,0,0]			
1 a mmm1'	0,0,0 [0,0,0]			

Continued

No. 20.2.95

$pmmm1'$

Symmetry of special projections

Along $[001]$ $2mm1'$

Origin at $0,0,z$

Along $[100]$ $p2mm1'$

$a^* = c$

Origin at $x,0,0$

Along $[010]$ $p2mm1'$

$a^* = c$

Origin at $0,y,0$

$pm'm'm'$

No. 20.3.96

$m'm'm'$

$p2/m'2/m'2/m'$

Orthorhombic

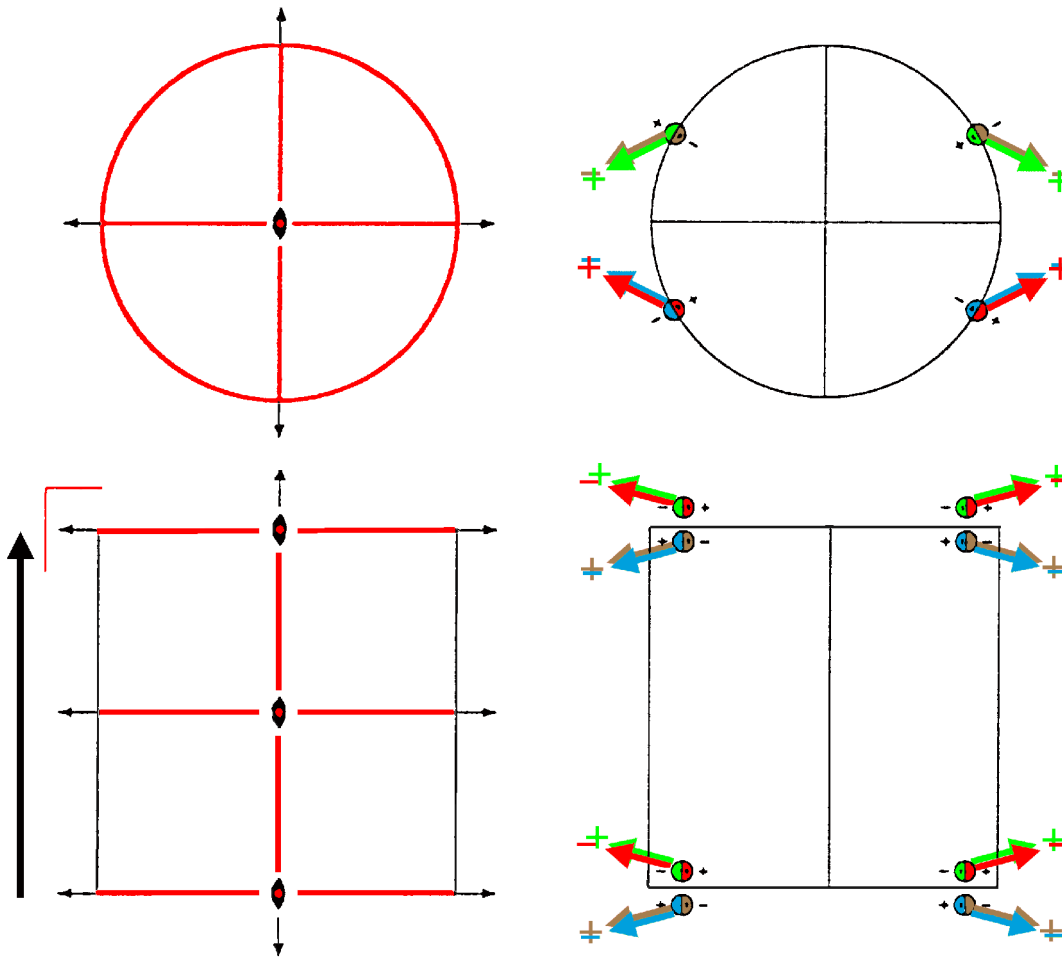

Origin at center ($m'm'm'$)

Asymmetric unit $0 \leq x; 0 \leq y; 0 \leq z \leq 1/2$

Symmetry operations

(1) 1
(1|0,0,0)

(2) 2 0,0,z
(2_z|0,0,0)

(3) 2 0,y,0
(2_y|0,0,0)

(4) 2 x,0,0
(2_x|0,0,0)

(5) $\bar{1}$ 0,0,0
($\bar{1}$ |0,0,0)

(6) m' x,y,0
(m'_z |0,0,0)

(7) m' x,0,z
(m'_y |0,0,0)

(8) m' 0,y,z
(m'_x |0,0,0)

Generators selected (1); t(0,0,1); (2); (3); (5)

Positions

Multiplicity, Wyckoff letter, Site symmetry	Coordinates			
	(1) x,y,z [u,v,w]	(2) \bar{x},\bar{y},z [\bar{u},\bar{v},w]	(3) \bar{x},y,\bar{z} [\bar{u},v,\bar{w}]	(4) x, \bar{y},\bar{z} [u, \bar{v},\bar{w}]
8 l 1	(5) \bar{x},\bar{y},\bar{z} [\bar{u},\bar{v},\bar{w}]	(6) x,y, \bar{z} [u,v, \bar{w}]	(7) x, \bar{y},z [u, \bar{v},w]	(8) \bar{x},y,z [\bar{u},v,w]
4 k ..m'	x,y,1/2 [u,v,0]	$\bar{x},\bar{y},1/2$ [$\bar{u},\bar{v},0$]	$\bar{x},y,1/2$ [$\bar{u},v,0$]	x, $\bar{y},1/2$ [u, $\bar{v},0$]
4 j ..m'	x,y,0 [u,v,0]	$\bar{x},\bar{y},0$ [$\bar{u},\bar{v},0$]	$\bar{x},y,0$ [$\bar{u},v,0$]	x, $\bar{y},0$ [u, $\bar{v},0$]
4 i .m'	x,0,z [u,0,w]	$\bar{x},0,z$ [$\bar{u},0,w$]	$\bar{x},0,\bar{z}$ [$\bar{u},0,\bar{w}$]	x,0, \bar{z} [u,0, \bar{w}]
4 h m'..	0,y,z [0,v,w]	0, \bar{y},z [0, \bar{v},w]	0,y, \bar{z} [0,v, \bar{w}]	0, \bar{y},\bar{z} [0, \bar{v},\bar{w}]
2 g m'm'2	0,0,z [0,0,w]	0,0, \bar{z} [0,0, \bar{w}]		
2 f m'2m'	0,y,1/2 [0,v,0]	0, $\bar{y},1/2$ [0, $\bar{v},0$]		
2 e m'2m'	0,y,0 [0,v,0]	0, $\bar{y},0$ [0, $\bar{v},0$]		
2 d 2m'm'	x,0,1/2 [u,0,0]	$\bar{x},0,1/2$ [$\bar{u},0,0$]		
2 c 2m'm'	x,0,0 [u,0,0]	$\bar{x},0,0$ [$\bar{u},0,0$]		
1 b m'm'm'	0,0,1/2 [0,0,0]			
1 a m'm'm'	0,0,0 [0,0,0]			

Continued

No. 20.3.96

$pm'm'm'$

Symmetry of special projections

Along $[001]$ $2m'm'$

Origin at $0,0,z$

Along $[100]$ $p2m'm'$

$a^* = c$

Origin at $x,0,0$

Along $[010]$ $p2m'm'$

$a^* = c$

Origin at $0,y,0$

$pm'm'm$

$m'm'm'm$

Orthorhombic

No. 20.4.97

$p2'm'2'/m'2'/m$

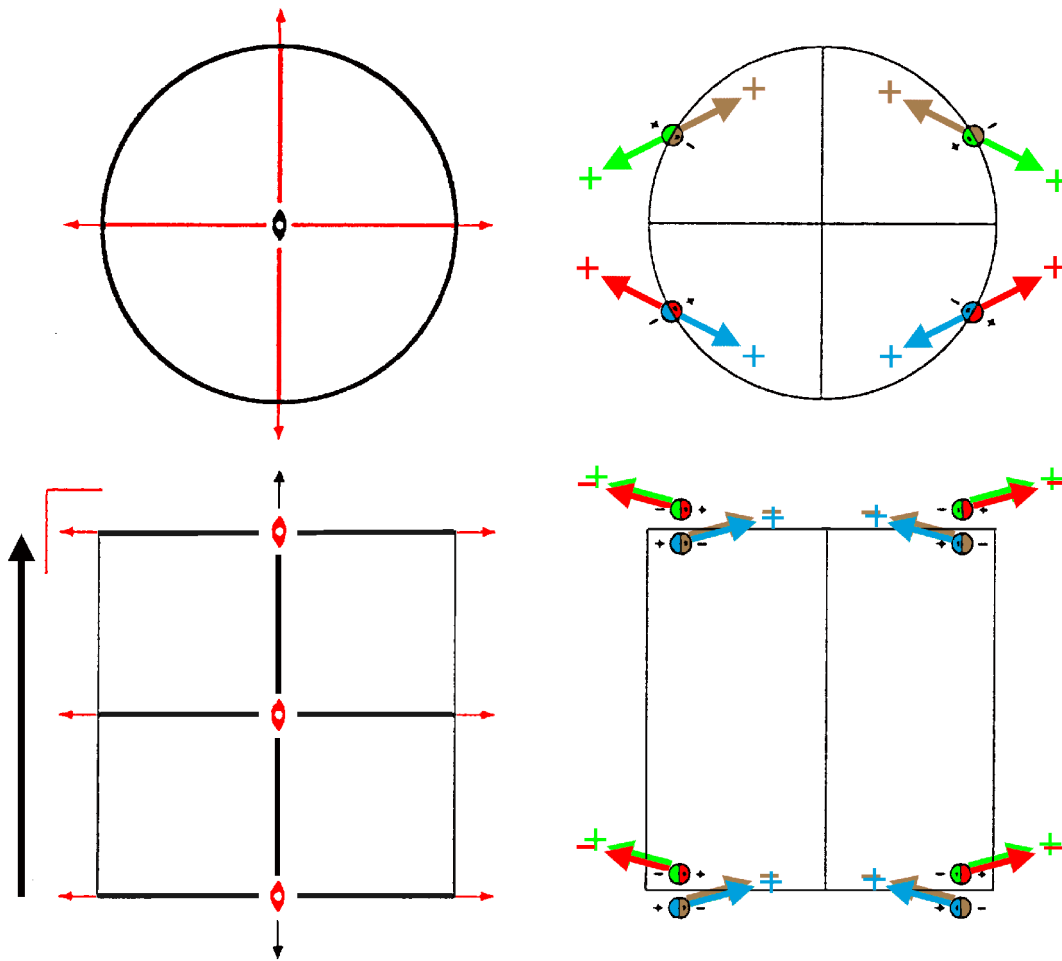

Origin at center ($m'm'm'm$)

Asymmetric unit $0 \leq x; 0 \leq y; 0 \leq z \leq 1/2$

Symmetry operations

- | | | | |
|--|---|--|--|
| (1) 1
(1 0,0,0) | (2) 2 _z 0,0,z
(2 _z 0,0,0) | (3) 2' _y 0,y,0
(2' _y 0,0,0)' | (4) 2' _x x,0,0
(2' _x 0,0,0)' |
| (5) $\bar{1}$ 0,0,0
($\bar{1}$ 0,0,0) | (6) m _x x,y,0
(m _x 0,0,0) | (7) m' _x x,0,z
(m' _x 0,0,0)' | (8) m' _y 0,y,z
(m' _y 0,0,0)' |

Generators selected (1); t(0,0,1); (2); (3); (5)

Positions

Multiplicity, Wyckoff letter, Site symmetry	Coordinates			
	(1) $x,y,z [u,v,w]$	(2) $\bar{x},\bar{y},z [\bar{u},\bar{v},w]$	(3) $\bar{x},y,\bar{z} [u,\bar{v},w]$	(4) $x,\bar{y},\bar{z} [\bar{u},v,w]$
8 l 1	(5) $\bar{x},\bar{y},\bar{z} [u,v,w]$	(6) $x,y,\bar{z} [\bar{u},\bar{v},w]$	(7) $x,\bar{y},z [u,\bar{v},w]$	(8) $\bar{x},y,z [\bar{u},v,w]$
4 k ..m	$x,y,1/2 [0,0,w]$	$\bar{x},\bar{y},1/2 [0,0,w]$	$\bar{x},y,1/2 [0,0,w]$	$x,\bar{y},1/2 [0,0,w]$
4 j ..m	$x,y,0 [0,0,w]$	$\bar{x},\bar{y},0 [0,0,w]$	$\bar{x},y,0 [0,0,w]$	$x,\bar{y},0 [0,0,w]$
4 i .m'	$x,0,z [u,0,w]$	$\bar{x},0,z [\bar{u},0,w]$	$\bar{x},0,\bar{z} [u,0,w]$	$x,0,\bar{z} [\bar{u},0,w]$
4 h m'..	$0,y,z [0,v,w]$	$0,\bar{y},z [0,\bar{v},w]$	$0,y,\bar{z} [0,\bar{v},w]$	$0,\bar{y},\bar{z} [0,v,w]$
2 g m'm'2	$0,0,z [0,0,w]$	$0,0,\bar{z} [0,0,w]$		
2 f m'2'm	$0,y,1/2 [0,0,w]$	$0,\bar{y},1/2 [0,0,w]$		
2 e m'2'm	$0,y,0 [0,0,w]$	$0,\bar{y},0 [0,0,w]$		
2 d 2'm'm	$x,0,1/2 [0,0,w]$	$\bar{x},0,1/2 [0,0,w]$		
2 c 2'm'm	$x,0,0 [0,0,w]$	$\bar{x},0,0 [0,0,w]$		
1 b m'm'm	$0,0,1/2 [0,0,w]$			
1 a m'm'm	$0,0,0 [0,0,w]$			

Continued

No. 20.4.97

$pm'm'm$

Symmetry of special projections

Along $[001]$ $2mm1'$

Origin at $0,0,z$

Along $[100]$ $p2m'm'$

$a^* = c$

Origin at $x,0,0$

Along $[010]$ $p2m'm'$

$a^* = c$

Origin at $0,y,0$

$pmm'm'$

No. 20.5.98

$mm'm'$

$p2/m2'/m'2'/m'$

Orthorhombic

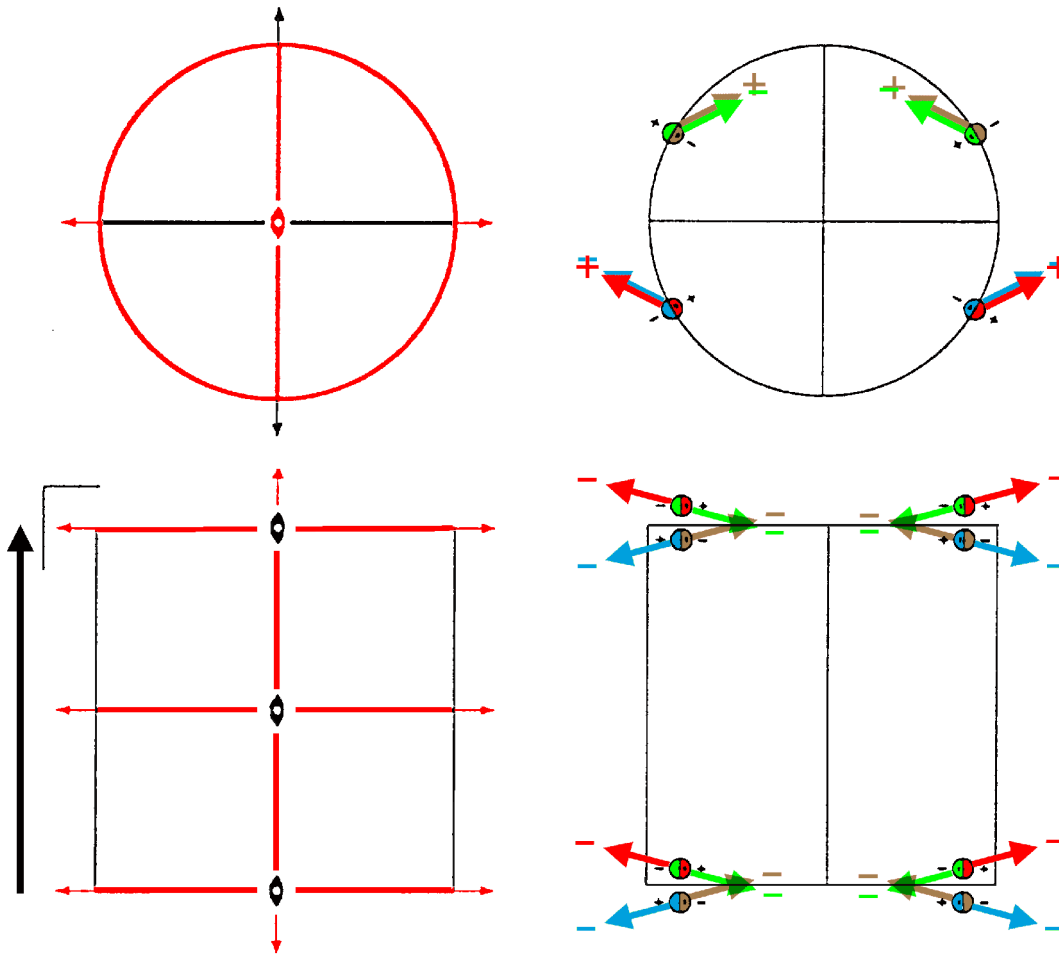

Origin at center ($mm'm'$)

Asymmetric unit $0 \leq x$; $0 \leq y$; $0 \leq z \leq 1/2$

Symmetry operations

(1) 1
(1|0,0,0)

(2) $2'_z$ 0,0,z
(2_z |0,0,0)'

(3) $2'_y$ 0,y,0
(2_y |0,0,0)'

(4) 2_x x,0,0
(2_x |0,0,0)

(5) $\bar{1}$ 0,0,0
($\bar{1}$ |0,0,0)

(6) m'_z x,y,0
(m_z |0,0,0)'

(7) m'_y x,0,z
(m_y |0,0,0)'

(8) m_x 0,y,z
(m_x |0,0,0)

Generators selected (1); t(0,0,1); (2); (3); (5)

Positions

Multiplicity, Wyckoff letter, Site symmetry	Coordinates			
	(1) $x,y,z [u,v,w]$	(2) $\bar{x},\bar{y},z [u,v,\bar{w}]$	(3) $\bar{x},y,\bar{z} [u,\bar{v},w]$	(4) $x,\bar{y},\bar{z} [u,\bar{v},\bar{w}]$
8 l 1	(5) $\bar{x},\bar{y},\bar{z} [u,v,w]$	(6) $x,y,\bar{z} [u,v,\bar{w}]$	(7) $x,\bar{y},z [u,\bar{v},w]$	(8) $\bar{x},y,z [u,\bar{v},\bar{w}]$
4 k ..m'	$x,y,1/2 [u,v,0]$	$\bar{x},\bar{y},1/2 [u,v,0]$	$\bar{x},y,1/2 [u,\bar{v},0]$	$x,\bar{y},1/2 [u,\bar{v},0]$
4 j ..m'	$x,y,0 [u,v,0]$	$\bar{x},\bar{y},0 [u,v,0]$	$\bar{x},y,0 [u,\bar{v},0]$	$x,\bar{y},0 [u,\bar{v},0]$
4 i .m'	$x,0,z [u,0,w]$	$\bar{x},0,z [u,0,\bar{w}]$	$\bar{x},0,\bar{z} [u,0,\bar{w}]$	$x,0,\bar{z} [u,0,w]$
4 h m..	$0,y,z [u,0,0]$	$0,\bar{y},z [u,0,0]$	$0,y,\bar{z} [u,0,0]$	$0,\bar{y},\bar{z} [u,0,0]$
2 g mm'2'	$0,0,z [u,0,0]$	$0,0,\bar{z} [u,0,0]$		
2 f m2'm'	$0,y,1/2 [u,0,0]$	$0,\bar{y},1/2 [u,0,0]$		
2 e m2'm'	$0,y,0 [u,0,0]$	$0,\bar{y},0 [u,0,0]$		
2 d 2m'm'	$x,0,1/2 [u,0,0]$	$\bar{x},0,1/2 [u,0,0]$		
2 c 2m'm'	$x,0,0 [u,0,0]$	$\bar{x},0,0 [u,0,0]$		
1 b mm'm'	$0,0,1/2 [u,0,0]$			
1 a mm'm'	$0,0,0 [u,0,0]$			

Continued

No. 20.5.98

$pmm'm'$

Symmetry of special projections

Along $[001]$ $2'mm'$

Origin at $0,0,z$

Along $[100]$ $p2mm1'$

$a^* = c$

Origin at $x,0,0$

Along $[010]$ $p2'm'm$

$a^* = c$

Origin at $0,y,0$

$pmmm'$

No. 20.6.99

mmm'

$p2'/m2'/m2'/m'$

Orthorhombic

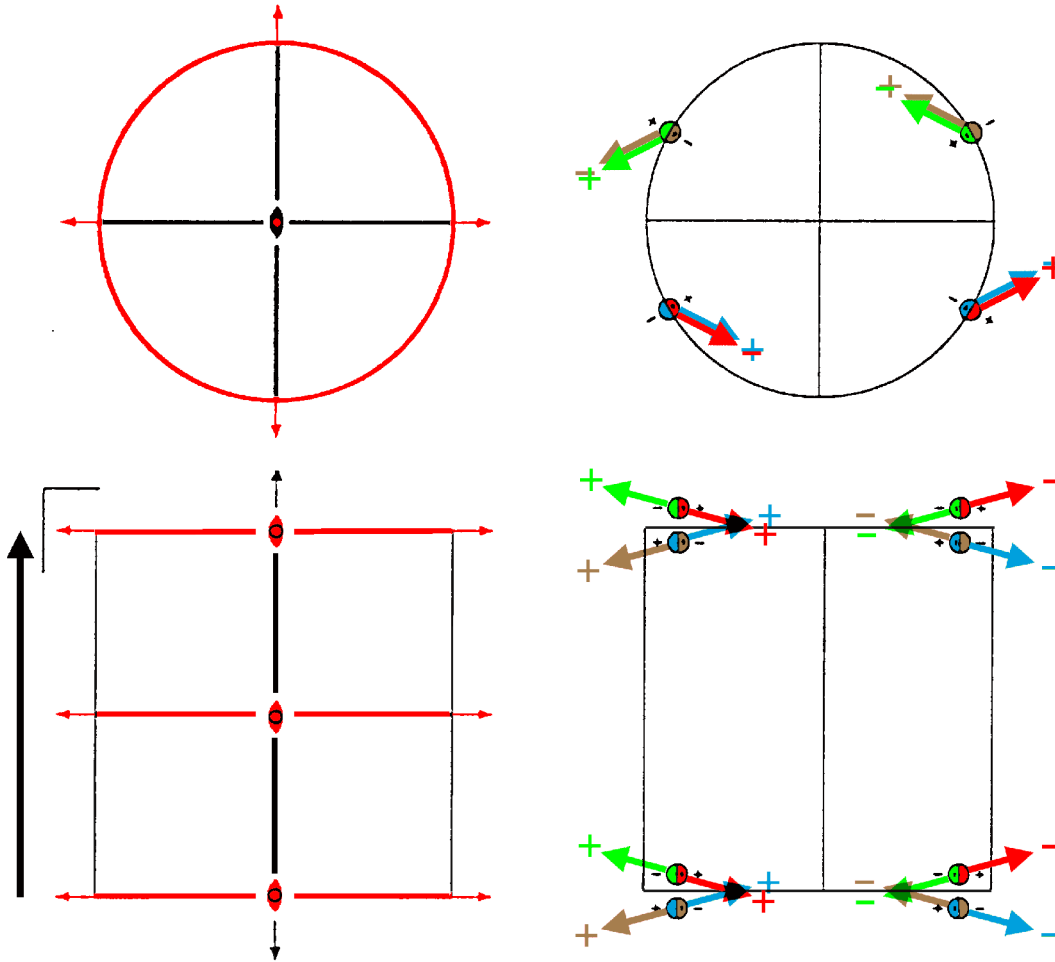

Origin at center (mmm')

Asymmetric unit $0 \leq x$; $0 \leq y$; $0 \leq z \leq 1/2$

Symmetry operations

- | | | | |
|---|--------------------------------------|------------------------------------|------------------------------------|
| (1) 1
(1 0,0,0) | (2) 2 $0,0,z$
(2_z 0,0,0) | (3) 2' $0,y,0$
(2_y 0,0,0)' | (4) 2' $x,0,0$
(2_x 0,0,0)' |
| (5) $\bar{1}$ $0,0,0$
($\bar{1}$ 0,0,0)' | (6) m' $x,y,0$
(m_z 0,0,0)' | (7) m $x,0,z$
(m_y 0,0,0) | (8) m $0,y,z$
(m_x 0,0,0) |

Generators selected (1); t(0,0,1); (2); (3); (5)

Positions

Multiplicity, Wyckoff letter, Site symmetry	Coordinates			
	(1) x,y,z [u,v,w]	(2) \bar{x},\bar{y},z [\bar{u},\bar{v},w]	(3) \bar{x},y,\bar{z} [u, \bar{v},w]	(4) x,\bar{y},\bar{z} [\bar{u},v,w]
8 l 1	(5) \bar{x},\bar{y},\bar{z} [\bar{u},\bar{v},\bar{w}]	(6) x,y,\bar{z} [u,v, \bar{w}]	(7) x,\bar{y},z [\bar{u},v,\bar{w}]	(8) \bar{x},y,z [u, \bar{v},\bar{w}]
4 k ..m'	$x,y,1/2$ [u,v,0]	$\bar{x},\bar{y},1/2$ [$\bar{u},\bar{v},0$]	$\bar{x},y,1/2$ [u, $\bar{v},0$]	$x,\bar{y},1/2$ [$\bar{u},v,0$]
4 j ..m'	$x,y,0$ [u,v,0]	$\bar{x},\bar{y},0$ [$\bar{u},\bar{v},0$]	$\bar{x},y,0$ [u, $\bar{v},0$]	$x,\bar{y},0$ [$\bar{u},v,0$]
4 i .m.	$x,0,z$ [0,v,0]	$\bar{x},0,z$ [0, $\bar{v},0$]	$\bar{x},0,\bar{z}$ [0, $\bar{v},0$]	$x,0,\bar{z}$ [0,v,0]
4 h m..	$0,y,z$ [u,0,0]	$0,\bar{y},z$ [$\bar{u},0,0$]	$0,y,\bar{z}$ [u,0,0]	$0,\bar{y},\bar{z}$ [$\bar{u},0,0$]
2 g mm2	$0,0,z$ [0,0,0]	$0,0,\bar{z}$ [0,0,0]		
2 f m2'm'	$0,y,1/2$ [u,0,0]	$0,\bar{y},1/2$ [$\bar{u},0,0$]		
2 e m2'm'	$0,y,0$ [u,0,0]	$0,\bar{y},0$ [$\bar{u},0,0$]		
2 d 2'mm'	$x,0,1/2$ [0,v,0]	$\bar{x},0,1/2$ [0, $\bar{v},0$]		
2 c 2'mm'	$x,0,0$ [0,v,0]	$\bar{x},0,0$ [0, $\bar{v},0$]		
1 b mmm'	$0,0,1/2$ [0,0,0]			
1 a mmm'	$0,0,0$ [0,0,0]			

Continued

No. 20.6.99

$pmmm'$

Symmetry of special projections

Along $[001]$ $2mm$

Origin at $0,0,z$

Along $[100]$ $pm2mm1'$

$a^* = c$

Origin at $x,0,0$

Along $[010]$ $pm2mm1'$

$a^* = c$

Origin at $0,y,0$

$pm'mm$

No. 20.7.100

$m'mm$

$p2/m'2'/m2'/m$

Orthorhombic

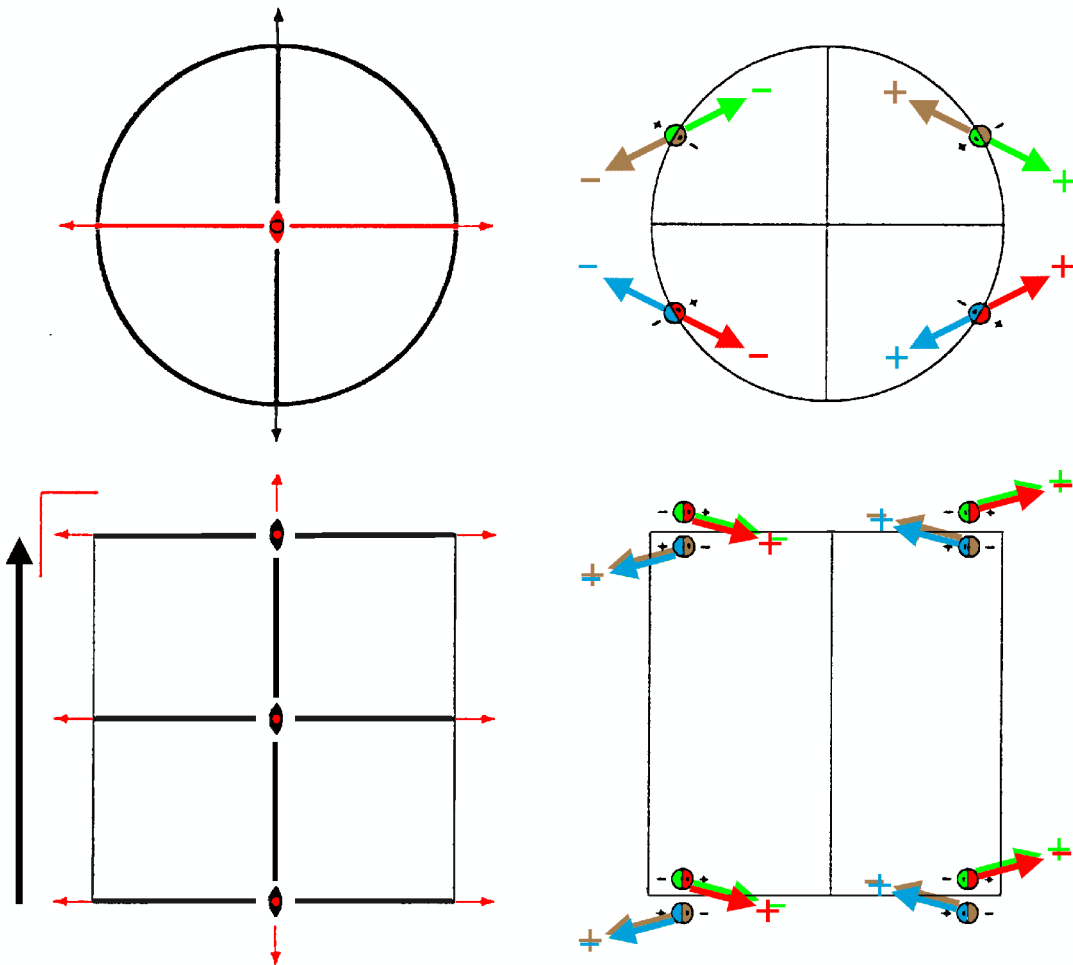

Origin at center ($m'mm$)

Asymmetric unit $0 \leq x$; $0 \leq y$; $0 \leq z \leq 1/2$

Symmetry operations

- | | | | |
|---|--------------------------------------|--------------------------------------|--------------------------------------|
| (1) 1
(1 0,0,0) | (2) $2'_z$ 0,0,z
(2_z 0,0,0)' | (3) $2'_y$ 0,y,0
(2_y 0,0,0)' | (4) $2'_x$ x,0,0
(2_x 0,0,0) |
| (5) $\bar{1}$ 0,0,0
($\bar{1}$ 0,0,0)' | (6) m x,y,0
(m_z 0,0,0) | (7) m x,0,z
(m_y 0,0,0) | (8) m'_z 0,y,z
(m_x 0,0,0)' |

Generators selected (1); t(0,0,1); (2); (3); (5)

Positions

Multiplicity, Wyckoff letter, Site symmetry	Coordinates			
	(1) x,y,z [u,v,w]	(2) \bar{x},\bar{y},z [u,v, \bar{w}]	(3) \bar{x},y,\bar{z} [u, \bar{v} ,w]	(4) x,\bar{y},\bar{z} [u, \bar{v},\bar{w}]
8 l 1	(5) \bar{x},\bar{y},\bar{z} [\bar{u},\bar{v},\bar{w}]	(6) x,y,\bar{z} [\bar{u},\bar{v},w]	(7) x,\bar{y},z [\bar{u},v,\bar{w}]	(8) \bar{x},y,z [\bar{u},v,w]
4 k ..m	$x,y,1/2$ [0,0,w]	$\bar{x},\bar{y},1/2$ [0,0, \bar{w}]	$\bar{x},y,1/2$ [0,0,w]	$x,\bar{y},1/2$ [0,0, \bar{w}]
4 j ..m	$x,y,0$ [0,0,w]	$\bar{x},\bar{y},0$ [0,0, \bar{w}]	$\bar{x},y,0$ [0,0,w]	$x,\bar{y},0$ [0,0, \bar{w}]
4 i .m.	$x,0,z$ [0,v,0]	$\bar{x},0,z$ [0,v,0]	$\bar{x},0,\bar{z}$ [0, \bar{v} ,0]	$x,0,\bar{z}$ [0, \bar{v} ,0]
4 h m'..	$0,y,z$ [0,v,w]	$0,\bar{y},z$ [0,v, \bar{w}]	$0,y,\bar{z}$ [0, \bar{v} ,w]	$0,\bar{y},\bar{z}$ [0, \bar{v},\bar{w}]
2 g m'm2'	$0,0,z$ [0,v,0]	$0,0,\bar{z}$ [0, \bar{v} ,0]		
2 f m'2'm	$0,y,1/2$ [0,0,w]	$0,\bar{y},1/2$ [0,0, \bar{w}]		
2 e m'2'm	$0,y,0$ [0,0,w]	$0,\bar{y},0$ [0,0, \bar{w}]		
2 d 2mm	$x,0,1/2$ [0,0,0]	$\bar{x},0,1/2$ [0,0,0]		
2 c 2mm	$x,0,0$ [0,0,0]	$\bar{x},0,0$ [0,0,0]		
1 b m'mm	$0,0,1/2$ [0,0,0]			
1 a m'mm	$0,0,0$ [0,0,0]			

Continued

No. 20.7.100

$pm'mm$

Symmetry of special projections

Along $[001]$ $2mm1'$

Origin at $0,0,z$

Along $[100]$ $p2mm$

$a^* = c$

Origin at $x,0,0$

Along $[010]$ $p2mm1'$

$a^* = c$

Origin at $0,y,0$

$p_{2c}m'm'm$

$mmm1'$

Orthorhombic

No. 20.8.101

$p_{2c}2'/m'2'/m'2'/m$

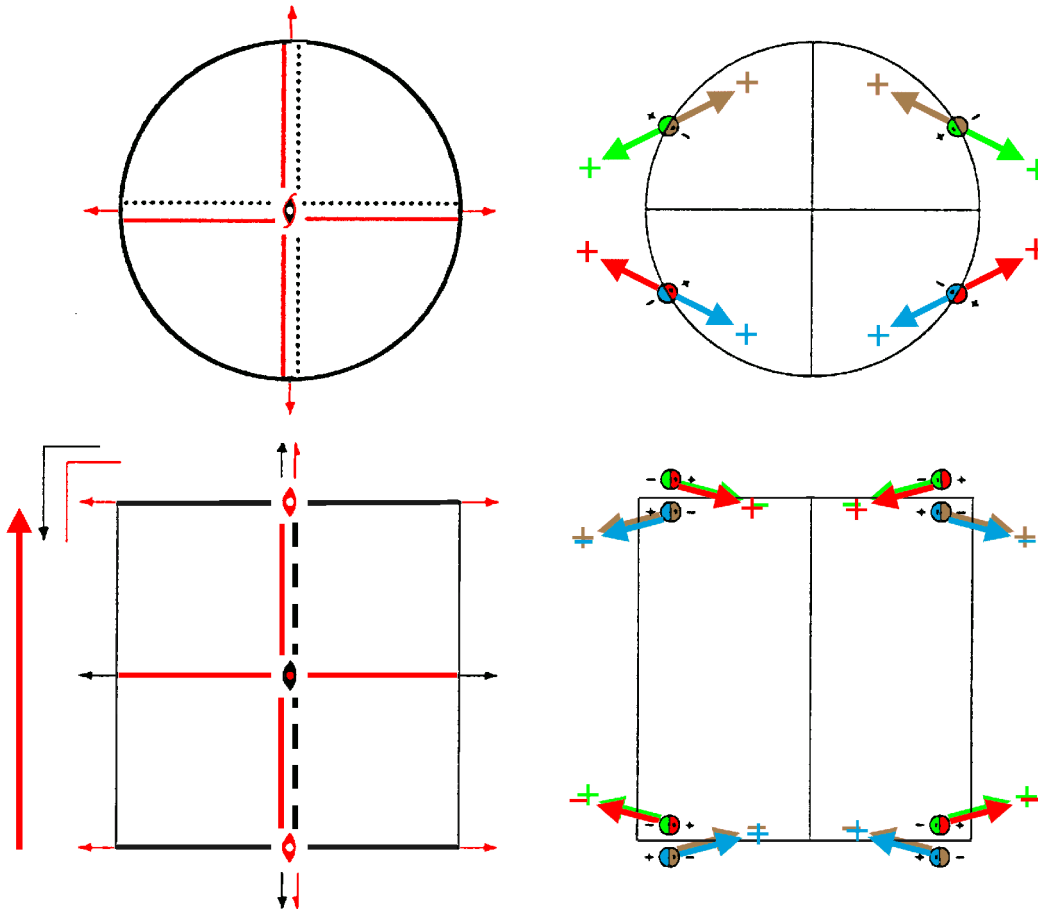

Origin at center ($m'm'm$)

Asymmetric unit $0 \leq x; 0 \leq y; 0 \leq z \leq 1/2$

Symmetry operations

For $(0,0,0)$ + set

- | | | | |
|--|----------------------------------|------------------------------------|------------------------------------|
| (1) 1
(1 0,0,0) | (2) 2 $0,0,z$
(2_z 0,0,0) | (3) 2' $0,y,0$
(2_y 0,0,0)' | (4) 2' $x,0,0$
(2_x 0,0,0)' |
| (5) $\bar{1}$ $0,0,0$
($\bar{1}$ 0,0,0) | (6) m $x,y,0$
(m_z 0,0,0) | (7) m' $x,0,z$
(m_y 0,0,0)' | (8) m' $0,y,z$
(m_x 0,0,0)' |

For $(0,0,1)'$ + set

- | | | | |
|---|--|--|--|
| (1) t' $(0,0,1)$
(1 0,0,1)' | (2) 2' $(0,0,1)$ $0,0,z$
(2_z 0,0,1)' | (3) 2 $0,y,1/2$
(2_y 0,0,1) | (4) 2 $x,0,1/2$
(2_x 0,0,1) |
| (5) $\bar{1}$ $0,0,1/2$
($\bar{1}$ 0,0,1)' | (6) m' $x,y,1/2$
(m_z 0,0,1)' | (7) c $(0,0,1)$ $x,0,z$
(m_y 0,0,1) | (8) c $(0,0,1)$ $0,y,z$
(m_x 0,0,1) |

Generators selected (1); t(0,0,1)' ; (2); (3); (5)

Positions

Multiplicity, Wyckoff letter, Site symmetry	Coordinates			
		(0,0,0)+	(0,0,1)' +	
8 l 1	(1) x,y,z [u,v,w]	(2) \bar{x},\bar{y},z [\bar{u},\bar{v},w]	(3) \bar{x},y,\bar{z} [u, \bar{v},w]	(4) x, \bar{y},\bar{z} [\bar{u},v,w]
	(5) \bar{x},\bar{y},\bar{z} [u,v,w]	(6) x,y, \bar{z} [\bar{u},\bar{v},w]	(7) x, \bar{y},z [u, \bar{v},w]	(8) \bar{x},y,z [\bar{u},v,w]
4 k ..m'	x,y,1/2 [u,v,0]	$\bar{x},\bar{y},1/2$ [$\bar{u},\bar{v},0$]	$\bar{x},y,1/2$ [u,v,0]	x, $\bar{y},1/2$ [$\bar{u},\bar{v},0$]
4 j ..m	x,y,0 [0,0,w]	$\bar{x},\bar{y},0$ [0,0,w]	$\bar{x},y,0$ [0,0,w]	x, $\bar{y},0$ [0,0,w]
4 i .m'	x,0,z [u,0,w]	$\bar{x},0,z$ [$\bar{u},0,w$]	$\bar{x},0,\bar{z}$ [u,0,w]	x,0, \bar{z} [$\bar{u},0,w$]
4 h m'..	0,y,z [0,v,w]	0, \bar{y},z [0, \bar{v},w]	0,y, \bar{z} [0, \bar{v},w]	0, \bar{y},\bar{z} [0,v,w]
2 g m'm'2	0,0,z [0,0,w]	0,0, \bar{z} [0,0,w]		
2 f m'2m'	0,y,1/2 [0,v,0]	0, $\bar{y},1/2$ [0, $\bar{v},0$]		
2 e m'2'm	0,y,0 [0,0,w]	0, $\bar{y},0$ [0,0,w]		
2 d 2m'm'	x,0,1/2 [u,0,0]	$\bar{x},0,1/2$ [$\bar{u},0,0$]		
2 c 2'm'm	x,0,0 [0,0,w]	$\bar{x},0,0$ [0,0,w]		
1 b m'm'm'	0,0,1/2 [0,0,0]			
1 a m'm'm	0,0,0 [0,0,w]			

Continued

No. 20.8.101

p_{2c} m'm'm

Symmetry of special projections

Along [001] $2mm1'$

Origin at 0,0,z

Along [100] $p_{2a^*} 2m'm'$

$a^* = c$

Origin at x,0,1/2

Along [010] $p_{2a^*} 2m'm'$

$a^* = c$

Origin at 0,y,1/2

$p_{2c}mm'm'$

$mmm1'$

Orthorhombic

No. 20.9.102

$p_{2c}2/m2'/m'2'/m'$

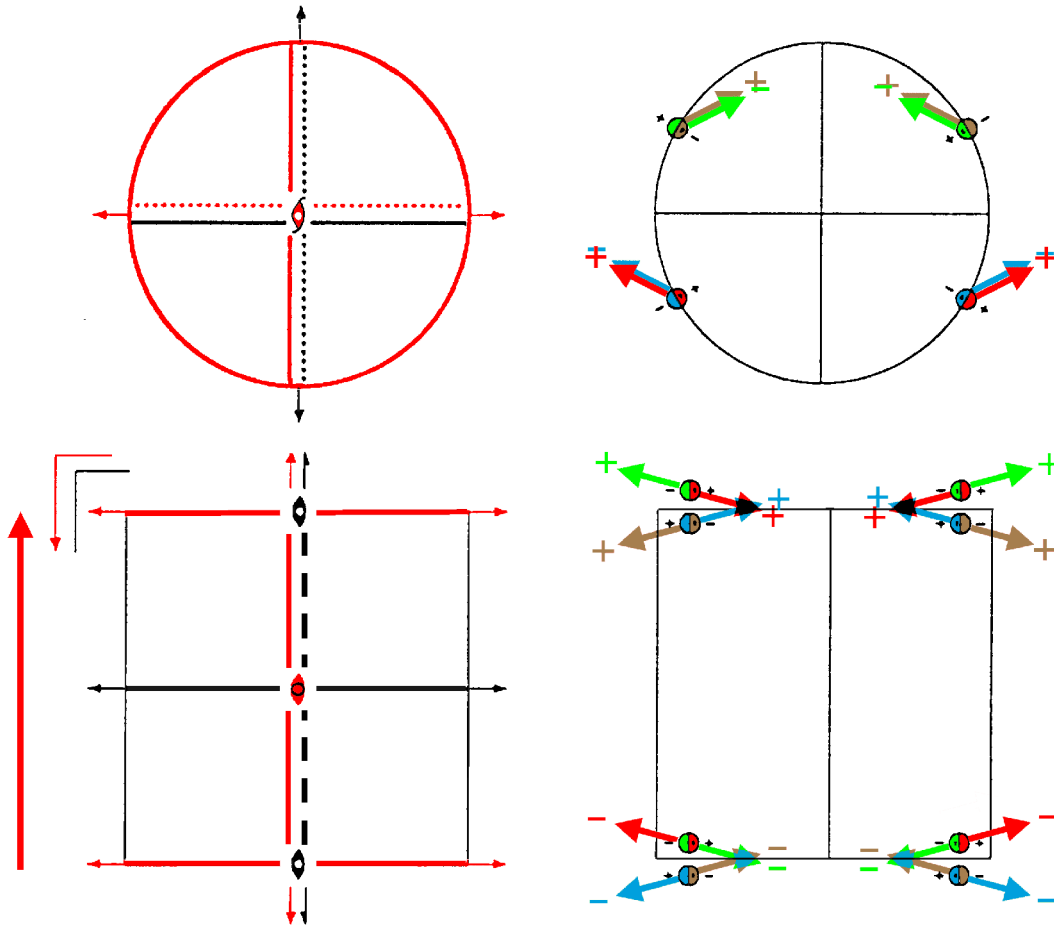

Origin at center ($mm'm'$)

Asymmetric unit $0 \leq x$; $0 \leq y$; $0 \leq z \leq 1/2$

Symmetry operations

For $(0,0,0)$ + set

- | | | | |
|--|---------------------------------------|---------------------------------------|--------------------------------------|
| (1) 1
(1 0,0,0) | (2) $2'_z$ 0,0,z
($2'_z$ 0,0,0)' | (3) $2'_y$ 0,y,0
($2'_y$ 0,0,0)' | (4) $2'_x$ x,0,0
($2'_x$ 0,0,0) |
| (5) $\bar{1}$ 0,0,0
($\bar{1}$ 0,0,0) | (6) m'_z x,y,0
(m'_z 0,0,0)' | (7) m'_y x,0,z
(m'_y 0,0,0)' | (8) m'_x 0,y,z
(m'_x 0,0,0) |

For $(0,0,1)'$ + set

- | | | | |
|--|--|---|---|
| (1) t' (0,0,1)
(1 0,0,1)' | (2) $2'_z$ (0,0,1) 0,0,z
($2'_z$ 0,0,1) | (3) $2'_y$ 0,y, $1/2$
($2'_y$ 0,0,1) | (4) $2'_x$ x,0, $1/2$
($2'_x$ 0,0,1)' |
| (5) $\bar{1}$ 0,0, $1/2$
($\bar{1}$ 0,0,1)' | (6) m'_z x,y, $1/2$
(m'_z 0,0,1) | (7) c (0,0,1) x,0,z
(m'_y 0,0,1) | (8) c' (0,0,1) 0,y,z
(m'_x 0,0,1)' |

Generators selected (1); t(0,0,1)' ; (2); (3); (5)

Positions

Multiplicity, Wyckoff letter, Site symmetry	Coordinates	(0,0,0)+ (0,0,1)' +			
		(0,0,0)+	(0,0,1)'	(0,0,0)+	(0,0,1)'
8 l 1	(1) x,y,z [u,v,w]	(2) \bar{x},\bar{y},z [u,v, \bar{w}]	(3) \bar{x},y,\bar{z} [u, \bar{v} ,w]	(4) x, \bar{y},\bar{z} [u, \bar{v},\bar{w}]	
	(5) \bar{x},\bar{y},\bar{z} [u,v,w]	(6) x,y, \bar{z} [u,v, \bar{w}]	(7) x, \bar{y},z [u, \bar{v} ,w]	(8) \bar{x},y,z [u, \bar{v},\bar{w}]	
4 k ..m	x,y,1/2 [0,0,w]	$\bar{x},\bar{y},1/2$ [0,0, \bar{w}]	$\bar{x},y,1/2$ [0,0,w]	x, $\bar{y},1/2$ [0,0, \bar{w}]	
4 j ..m'	x,y,0 [u,v,0]	$\bar{x},\bar{y},0$ [u,v,0]	$\bar{x},y,0$ [u, \bar{v} ,0]	x, $\bar{y},0$ [u, \bar{v} ,0]	
4 i .m'	x,0,z [u,0,w]	$\bar{x},0,z$ [u,0, \bar{w}]	$\bar{x},0,\bar{z}$ [u,0,w]	x,0, \bar{z} [u,0, \bar{w}]	
4 h m..	0,y,z [u,0,0]	0, \bar{y},z [u,0,0]	0,y, \bar{z} [u,0,0]	0, \bar{y},\bar{z} [u,0,0]	
2 g mm'2'	0,0,z [u,0,0]	0,0, \bar{z} [u,0,0]			
2 f m2m	0,y,1/2 [0,0,0]	0, $\bar{y},1/2$ [0,0,0]			
2 e m2'm'	0,y,0 [u,0,0]	0, $\bar{y},0$ [u,0,0]			
2 d 2'm'm	x,0,1/2 [0,0,w]	$\bar{x},0,1/2$ [0,0, \bar{w}]			
2 c 2m'm'	x,0,0 [u,0,0]	$\bar{x},0,0$ [u,0,0]			
1 b mm'm	0,0,1/2 [0,0,0]				
1 a mm'm'	0,0,0 [u,0,0]				

Continued

No. 20.9.102

p_{2c} mm'm'

Symmetry of special projections

Along [001] $2'mm'$

Origin at 0,0,z

Along [100] $p2mm1'$

$a^* = c$

Origin at x,0,0

Along [010] $p_{2a^*}2mm$

$a^* = c$

Origin at 0,y,1/2

p_{2c} mmm

mmm1'

Orthorhombic

No. 20.10.103

$p_{2c}2/m2/m2/m$

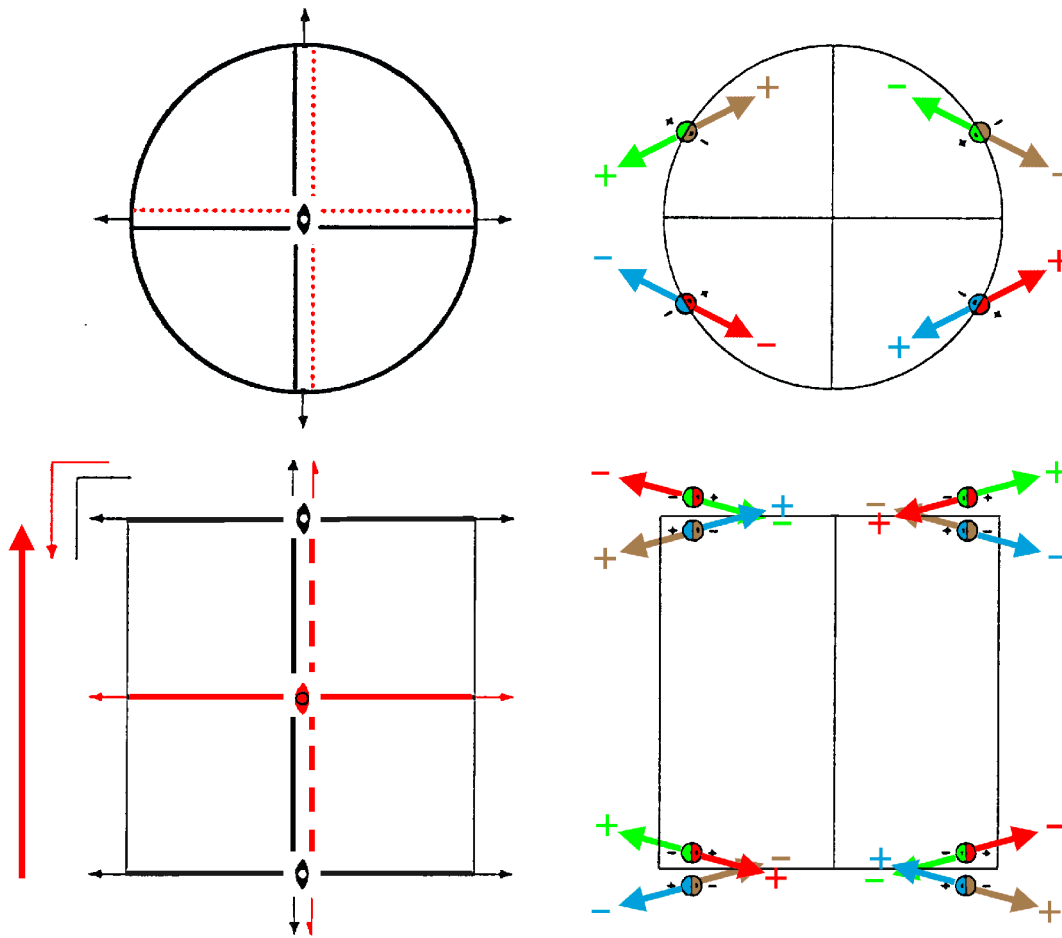

Origin at center (mmm)

Asymmetric unit $0 \leq x$; $0 \leq y$; $0 \leq z \leq 1/2$

Symmetry operations

For (0,0,0) + set

- | | | | |
|--|--|--|--|
| (1) 1
(1 0,0,0) | (2) 2 0,0,z
(2 _z 0,0,0) | (3) 2 0,y,0
(2 _y 0,0,0) | (4) 2 x,0,0
(2 _x 0,0,0) |
| (5) $\bar{1}$ 0,0,0
($\bar{1}$ 0,0,0) | (6) m x,y,0
(m _z 0,0,0) | (7) m x,0,z
(m _y 0,0,0) | (8) m 0,y,z
(m _x 0,0,0) |

For (0,0,1)' + set

- | | | | |
|---|--|---|---|
| (1) t' (0,0,1)
(1 0,0,1)' | (2) 2' (0,0,1) 0,0,z
(2 _z 0,0,1)' | (3) 2' 0,y,½
(2 _y 0,0,1)' | (4) 2' x,0,½
(2 _x 0,0,1)' |
| (5) $\bar{1}$ ' 0,0,½
($\bar{1}$ 0,0,1)' | (6) m' x,y,½
(m _z ' 0,0,1)' | (7) c' (0,0,1) x,0,z
(m _y ' 0,0,1)' | (8) c' (0,0,1) 0,y,z
(m _x ' 0,0,1)' |

Generators selected (1); $t(0,0,1)'$; (2); (3); (5)

Positions

Multiplicity, Wyckoff letter, Site symmetry	Coordinates			
		(0,0,0)+	(0,0,1)' +	
8 l 1	(1) x,y,z [u,v,w]	(2) \bar{x},\bar{y},z [\bar{u},\bar{v},w]	(3) \bar{x},y,\bar{z} [\bar{u},v,\bar{w}]	(4) x, \bar{y},\bar{z} [u, \bar{v},\bar{w}]
	(5) \bar{x},\bar{y},\bar{z} [u,v,w]	(6) x,y, \bar{z} [\bar{u},\bar{v},w]	(7) x, \bar{y},z [\bar{u},v,\bar{w}]	(8) \bar{x},y,z [u, \bar{v},\bar{w}]
4 k ..m'	x,y,1/2 [u,v,0]	$\bar{x},\bar{y},1/2$ [$\bar{u},\bar{v},0$]	$\bar{x},y,1/2$ [u, $\bar{v},0$]	x, $\bar{y},1/2$ [$\bar{u},v,0$]
4 j ..m	x,y,0 [0,0,w]	$\bar{x},\bar{y},0$ [0,0,w]	$\bar{x},y,0$ [0,0, \bar{w}]	x, $\bar{y},0$ [0,0, \bar{w}]
4 i .m.	x,0,z [0,v,0]	$\bar{x},0,z$ [0, $\bar{v},0$]	$\bar{x},0,\bar{z}$ [0,v,0]	x,0, \bar{z} [0, $\bar{v},0$]
4 h m..	0,y,z [u,0,0]	0, \bar{y},z [$\bar{u},0,0$]	0,y, \bar{z} [$\bar{u},0,0$]	0, \bar{y},\bar{z} [u,0,0]
2 g mm2	0,0,z [0,0,0]	0,0, \bar{z} [0,0,0]		
2 f m2'm'	0,y,1/2 [u,0,0]	0, $\bar{y},1/2$ [$\bar{u},0,0$]		
2 e m2m	0,y,0 [0,0,0]	0, $\bar{y},0$ [0,0,0]		
2 d 2'mm'	x,0,1/2 [0,v,0]	$\bar{x},0,1/2$ [0, $\bar{v},0$]		
2 c 2mm	x,0,0 [0,0,0]	$\bar{x},0,0$ [0,0,0]		
1 b mmm'	0,0,1/2 [0,0,0]			
1 a mmm	0,0,0 [0,0,0]			

Continued

No. 20.10.103

p_{2c} mmm

Symmetry of special projections

Along [001] $2mm1'$

Origin at 0,0,z

Along [100] $p2mm1'$

$a^* = c$

Origin at x,0,0

Along [010] $p2mm1'$

$a^* = c$

Origin at 0,y,0

pccm

mmm

Orthorhombic

No. 21.1.104

$p2/c2/c2/m$

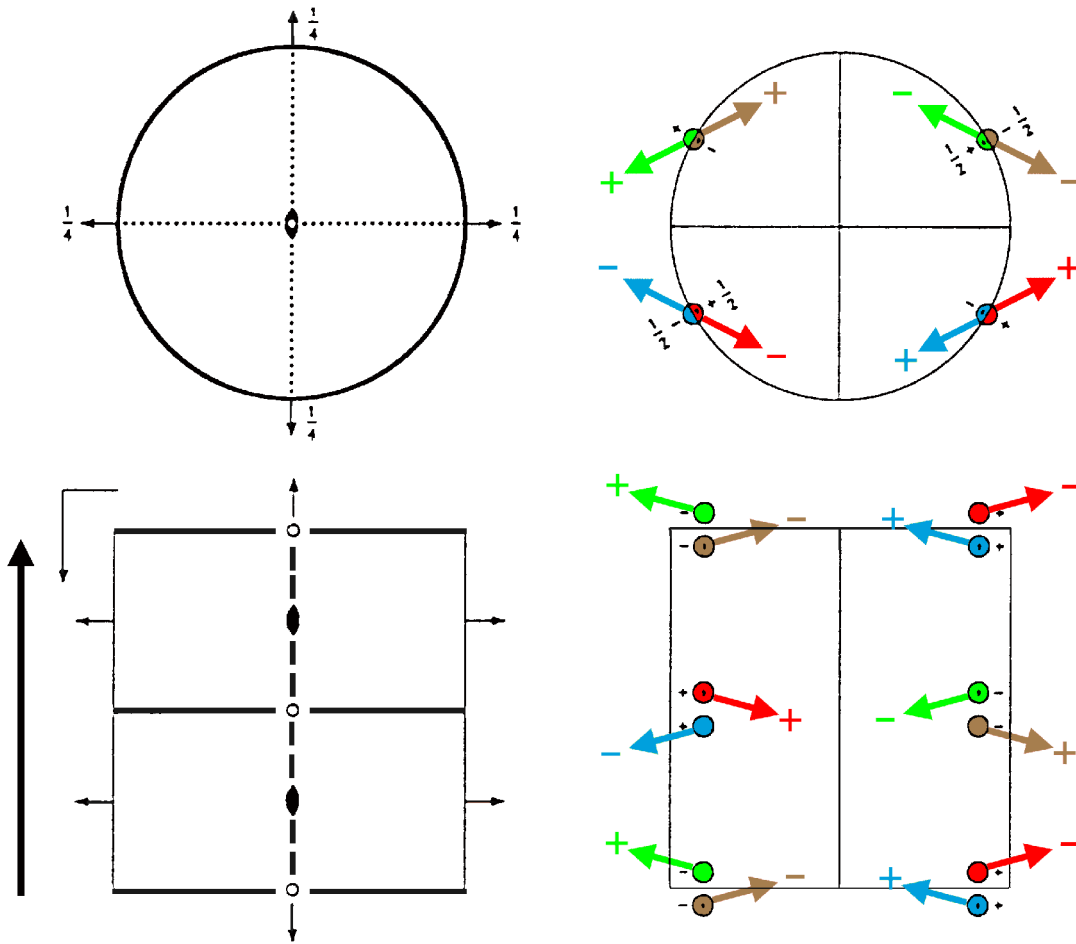

Origin at center (2/m) at cc2/m

Asymmetric unit $0 \leq x$; $0 \leq y$; $0 \leq z \leq 1/2$

Symmetry operations

- | | | | |
|--|--|--|--|
| (1) 1
(1 0,0,0) | (2) 2 0,0,z
(2 _z 0,0,0) | (3) 2 0,y,1/4
(2 _y 0,0,1/2) | (4) 2 x,0,1/4
(2 _x 0,0,1/2) |
| (5) $\bar{1}$ 0,0,0
($\bar{1}$ 0,0,0) | (6) m x,y,0
(m _z 0,0,0) | (7) c (0,0,1/2) x,0,z
(m _y 0,0,1/2) | (8) c (0,0,1/2) 0,y,z
(m _x 0,0,1/2) |

Generators selected (1); $t(0,0,1)$; (2); (3); (5)

Positions

	Coordinates		
Multiplicity, Wyckoff letter, Site symmetry			
8 g 1	(1) x,y,z [u,v,w]	(2) \bar{x},\bar{y},z [\bar{u},\bar{v},w]	
	(3) $\bar{x},y,\bar{z}+1/2$ [\bar{u},v,\bar{w}]	(4) $x,\bar{y},\bar{z}+1/2$ [u,\bar{v},\bar{w}]	
	(5) \bar{x},\bar{y},\bar{z} [u,v,w]	(6) x,y,\bar{z} [\bar{u},\bar{v},w]	
	(7) $x,\bar{y},z+1/2$ [$\bar{u},0,\bar{w}$]	(8) $\bar{x},y,z+1/2$ [u,\bar{v},\bar{w}]	
	4 f ..m	$x,y,0$ [0,0,w]	$\bar{x},\bar{y},0$ [0,0,w]
		$\bar{x},y,1/2$ [0,0, \bar{w}]	$x,\bar{y},1/2$ [0,0, \bar{w}]
	4 e ..2	$0,0,z$ [0,0,w]	$0,0,\bar{z}+1/2$ [0,0, \bar{w}]
		$0,0,\bar{z}$ [0,0,w]	$0,0,z+1/2$ [0,0, \bar{w}]
4 d .2.	$0,y,1/4$ [0,v,0]	$0,\bar{y},1/4$ [0, \bar{v} ,0]	
	$0,\bar{y},3/4$ [0,v,0]	$0,y,3/4$ [0, \bar{v} ,0]	
4 c 2..	$x,0,1/4$ [u,0,0]	$\bar{x},0,1/4$ [$\bar{u},0,0$]	
	$\bar{x},0,3/4$ [u,0,0]	$x,0,3/4$ [$\bar{u},0,0$]	
2 b 222	$0,0,1/4$ [0,0,0]	$0,0,3/4$ [0,0,0]	
2 a ..2/m	$0,0,0$ [0,0,w]	$0,0,1/2$ [0,0, \bar{w}]	

Symmetry of special projections

Along [001] $2mm1'$	Along [100] $p_{2a^*}2m'm'$ $a^* = c/2$	Along [010] $p_{2a^*}2m'm'$ $a^* = c/2$
Origin at 0,0,z	Origin at x,0,1/4	Origin at 0,y,1/4

$pccm1'$

$mmm1'$

Orthorhombic

No. 21.2.105

$p2/c2/c2/m1'$

$1'$

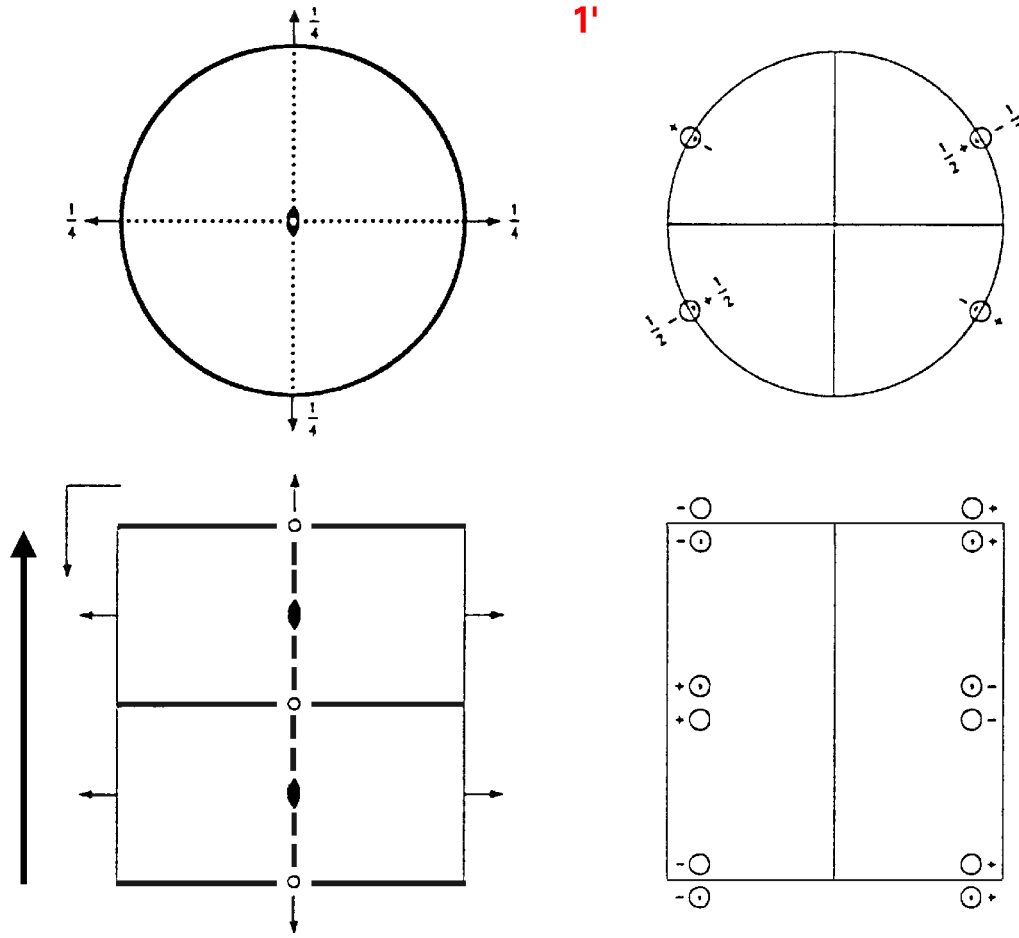

Origin at center ($2/m1'$) at $cc2/m1'$

Asymmetric unit $0 \leq x$; $0 \leq y$; $0 \leq z \leq 1/2$

Symmetry operations

For $1 +$ set

- | | | | |
|--|------------------------------------|--|--|
| (1) 1
($1 0,0,0$) | (2) 2 $0,0,z$
($2_z 0,0,0$) | (3) 2 $0,y,1/4$
($2_y 0,0,1/2$) | (4) 2 $x,0,1/4$
($2_x 0,0,1/2$) |
| (5) $\bar{1}$ $0,0,0$
($\bar{1} 0,0,0$) | (6) m $x,y,0$
($m_z 0,0,0$) | (7) c $(0,0,1/2)$ $x,0,z$
($m_y 0,0,1/2$) | (8) c $(0,0,1/2)$ $0,y,z$
($m_x 0,0,1/2$) |

For $1' +$ set

- | | | | |
|--|--------------------------------------|--|--|
| (1) $1'$
($1 0,0,0$)' | (2) $2'$ $0,0,z$
($2_z 0,0,0$)' | (3) $2'$ $0,y,1/4$
($2_y 0,0,1/2$)' | (4) $2'$ $x,0,1/4$
($2_x 0,0,1/2$)' |
| (5) $\bar{1}'$ $0,0,0$
($\bar{1} 0,0,0$)' | (6) m' $x,y,0$
($m_z 0,0,0$)' | (7) c' $(0,0,1/2)$ $x,0,z$
($m_y 0,0,1/2$)' | (8) c' $(0,0,1/2)$ $0,y,z$
($m_x 0,0,1/2$)' |

Generators selected (1); $t(0,0,1)$; (2); (3); (5); $1'$

Positions

Multiplicity, Wyckoff letter, Site symmetry	Coordinates	
	$1+$	$1' +$
8 g $11'$	(1) $x,y,z [0,0,0]$	(2) $\bar{x},\bar{y},z [0,0,0]$
	(3) $\bar{x},y,\bar{z}+1/2 [0,0,0]$	(4) $x,\bar{y},\bar{z}+1/2 [0,0,0]$
	(5) $\bar{x},\bar{y},\bar{z} [0,0,0]$	(6) $x,y,\bar{z} [0,0,0]$
	(7) $x,\bar{y},z+1/2 [0,0,0]$	(8) $\bar{x},y,z+1/2 [0,0,0]$
4 f $..m1'$	$x,y,0 [0,0,0]$	$\bar{x},\bar{y},0 [0,0,0]$
	$\bar{x},y,1/2 [0,0,0]$	$x,\bar{y},1/2 [0,0,0]$
4 e $..21'$	$0,0,z [0,0,0]$	$0,0,\bar{z}+1/2 [0,0,0]$
	$0,0,\bar{z} [0,0,0]$	$0,0,z+1/2 [0,0,0]$
4 d $.2.1'$	$0,y,1/4 [0,0,0]$	$0,\bar{y},1/4 [0,0,0]$
	$0,\bar{y},3/4 [0,0,0]$	$0,y,3/4 [0,0,0]$
4 c $2..1'$	$x,0,1/4 [0,0,0]$	$\bar{x},0,1/4 [0,0,0]$
	$\bar{x},0,3/4 [0,0,0]$	$x,0,3/4 [0,0,0]$
2 b $2221'$	$0,0,1/4 [0,0,0]$	$0,0,3/4 [0,0,0]$
2 a $..2/m1'$	$0,0,0 [0,0,0]$	$0,0,1/2 [0,0,0]$

Symmetry of special projections

Along [001] $2mm1'$	Along [100] $p2mm1'$	Along [010] $p2mm1'$
Origin at $0,0,z$	$a^* = c/2$ Origin at $x,0,0$	$a^* = c/2$ Origin at $0,y,0$

$pc'c'm'$

$m'm'm'$

Orthorhombic

No. 21.3.106

$p2/c'2/c'2/m'$

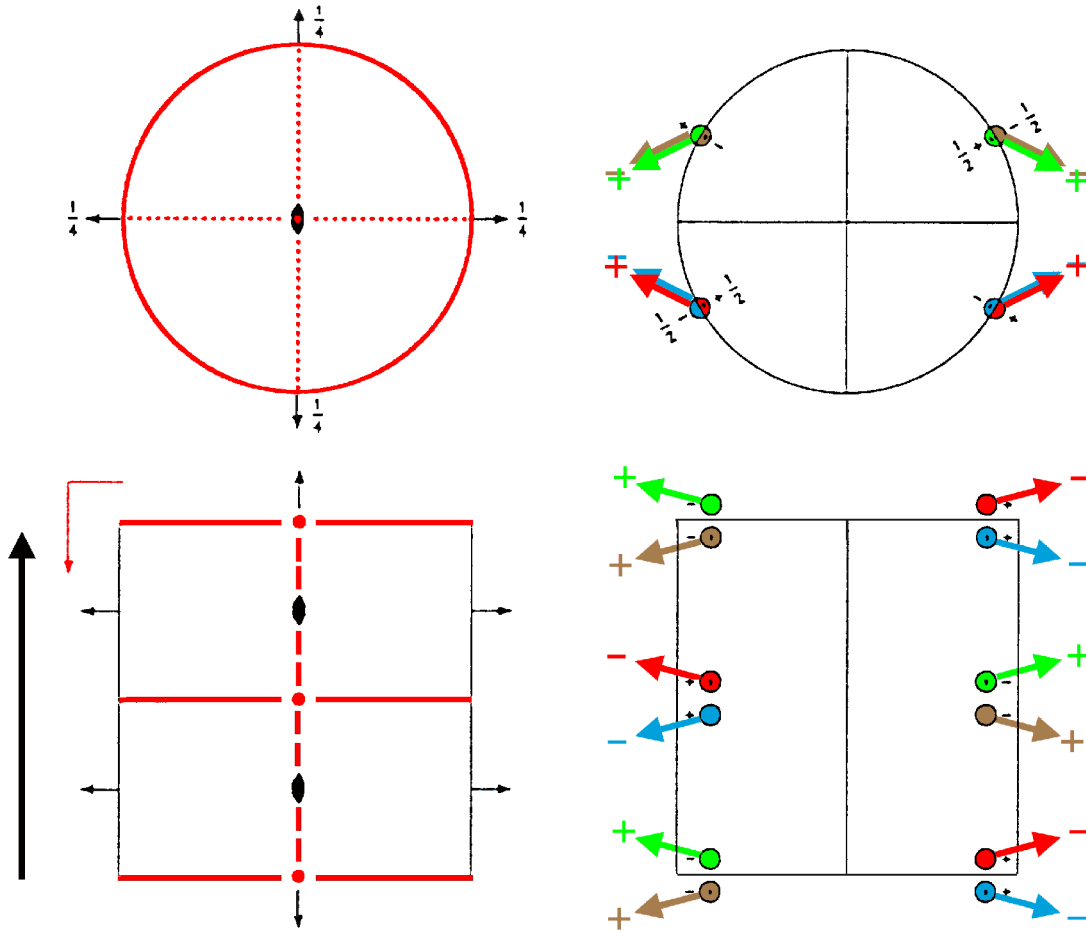

Origin at center ($2/m'$) at $c'c'2/m'$

Asymmetric unit $0 \leq x$; $0 \leq y$; $0 \leq z \leq 1/2$

Symmetry operations

- | | | | |
|--|-------------------------------------|---|---|
| (1) 1
(1 0,0,0) | (2) 2 $0,0,z$
(2_z 0,0,0) | (3) 2 $0,y,1/4$
(2_y 0,0,1/2) | (4) 2 $x,0,1/4$
(2_x 0,0,1/2) |
| (5) $\bar{1}$ $0,0,0$
($\bar{1}$ 0,0,0) | (6) m' $x,y,0$
(m_z 0,0,0) | (7) c' $(0,0,1/2)$ $x,0,z$
(m_y 0,0,1/2) | (8) c' $(0,0,1/2)$ $0,y,z$
(m_x 0,0,1/2) |

Generators selected (1); t(0,0,1); (2); (3); (5)

Positions

	Coordinates		
Multiplicity, Wyckoff letter, Site symmetry			
8 g 1	(1) x,y,z [u,v,w]	(2) \bar{x},\bar{y},z [\bar{u},\bar{v},w]	
	(3) $\bar{x},y,\bar{z}+1/2$ [\bar{u},v,\bar{w}]	(4) $x,\bar{y},\bar{z}+1/2$ [u,\bar{v},\bar{w}]	
	(5) \bar{x},\bar{y},\bar{z} [\bar{u},\bar{v},\bar{w}]	(6) x,y,\bar{z} [u,v,\bar{w}]	
	(7) $x,\bar{y},z+1/2$ [u,\bar{v},w]	(8) $\bar{x},y,z+1/2$ [\bar{u},v,w]	
	4 f ..m'	x,y,0 [u,v,0]	$\bar{x},\bar{y},0$ [$\bar{u},\bar{v},0$]
		$\bar{x},y,1/2$ [$\bar{u},v,0$]	$x,\bar{y},1/2$ [$u,\bar{v},0$]
	4 e ..2	0,0,z [0,0,w]	0,0, $\bar{z}+1/2$ [0,0, \bar{w}]
		0,0, \bar{z} [0,0, \bar{w}]	0,0,z+1/2 [0,0,w]
4 d .2.	0,y,1/4 [0,v,0]	0, $\bar{y},1/4$ [0, $\bar{v},0$]	
	0, $\bar{y},3/4$ [0, $\bar{v},0$]	0,y,3/4 [0,v,0]	
4 c 2..	x,0,1/4 [u,0,0]	$\bar{x},0,1/4$ [$\bar{u},0,0$]	
	$\bar{x},0,3/4$ [$\bar{u},0,0$]	x,0,3/4 [u,0,0]	
2 b 222	0,0,1/4 [0,0,0]	0,0,3/4 [0,0,0]	
2 a ..2/m'	0,0,0 [0,0,0]	0,0,1/2 [0,0,0]	

Symmetry of special projections

Along [001] 2m'm'	Along [100] p2m'm'	Along [010] p2m'm'
Origin at 0,0,z	$a^* = c/2$ Origin at x,0,0	$a^* = c/2$ Origin at 0,y,0

$pc'c'm$

$m'm'm$

Orthorhombic

No. 21.4.107

$p2'c'2'/c'2/m$

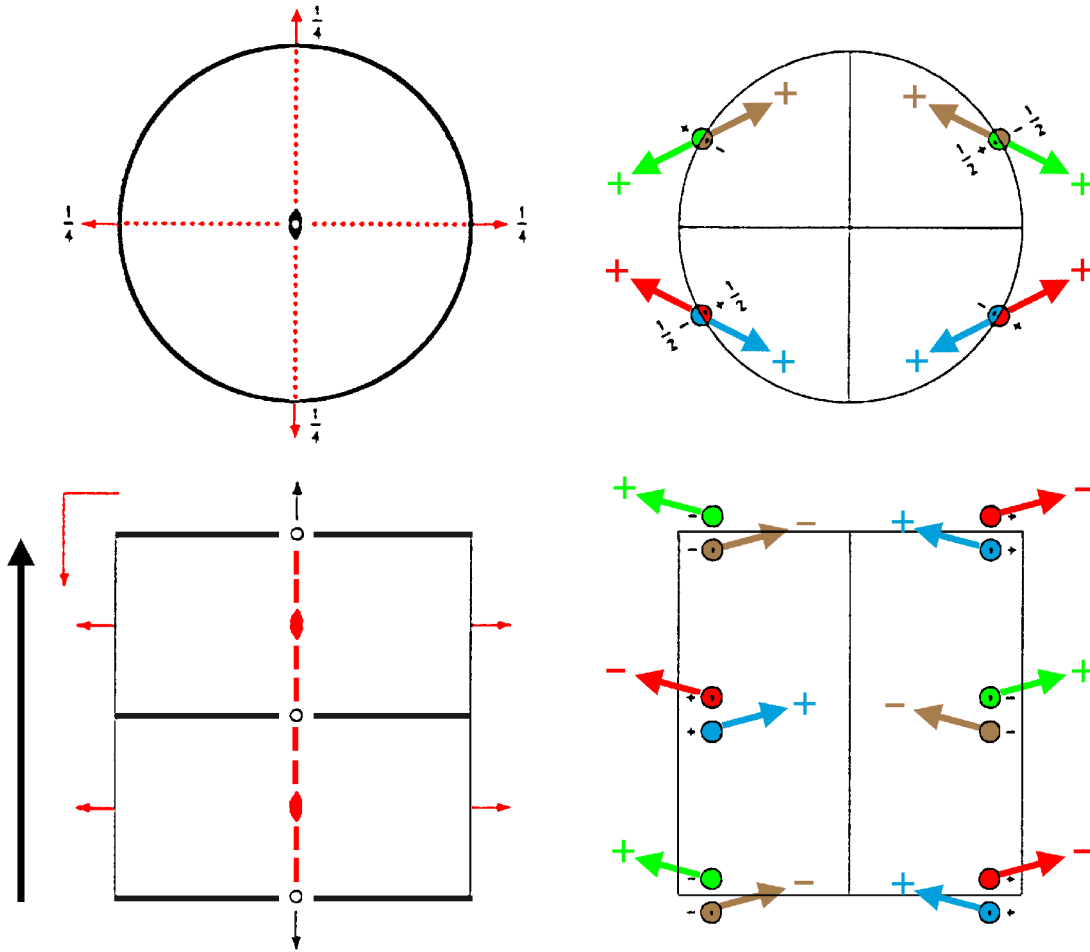

Origin at center ($2/m$) at $c'c'2'/m$

Asymmetric unit $0 \leq x$; $0 \leq y$; $0 \leq z \leq 1/2$

Symmetry operations

- | | | | |
|--|----------------------------------|--|--|
| (1) 1
(1 0,0,0) | (2) 2 $0,0,z$
(2_z 0,0,0) | (3) 2' $0,y,1/4$
(2_y 0,0,1/2)' | (4) 2' $x,0,1/4$
(2_x 0,0,1/2)' |
| (5) $\bar{1}$ 0,0,0
($\bar{1}$ 0,0,0) | (6) m $x,y,0$
(m_z 0,0,0) | (7) c' (0,0,1/2) $x,0,z$
(m_y 0,0,1/2)' | (8) c' (0,0,1/2) $0,y,z$
(m_x 0,0,1/2)' |

Generators selected (1); t(0,0,1); (2); (3); (5)

Positions

	Coordinates		
Multiplicity, Wyckoff letter, Site symmetry			
8 g 1	(1) x,y,z [u,v,w]	(2) \bar{x},\bar{y},z [\bar{u},\bar{v},w]	
	(3) $\bar{x},y,\bar{z}+1/2$ [u, \bar{v},w]	(4) x, $\bar{y},\bar{z}+1/2$ [\bar{u},v,w]	
	(5) \bar{x},\bar{y},\bar{z} [u,v,w]	(6) x,y, \bar{z} [\bar{u},\bar{v},w]	
	(7) x, $\bar{y},z+1/2$ [u, \bar{v},w]	(8) $\bar{x},y,z+1/2$ [\bar{u},v,w]	
	4 f ..m	x,y,0 [0,0,w]	$\bar{x},\bar{y},0$ [0,0,w]
		$\bar{x},y,1/2$ [0,0,w]	x, $\bar{y},1/2$ [0,0,w]
	4 e ..2	0,0,z [0,0,w]	0,0, $\bar{z}+1/2$ [0,0,w]
		0,0, \bar{z} [0,0,w]	0,0,z+1/2 [0,0,w]
4 d .2'	0,y,1/4 [u,0,w]	0, $\bar{y},1/4$ [$\bar{u},0,w$]	
	0, $\bar{y},3/4$ [u,0,w]	0,y,3/4 [$\bar{u},0,w$]	
4 c 2'..	x,0,1/4 [0,v,w]	$\bar{x},0,1/4$ [0, \bar{v},w]	
	$\bar{x},0,3/4$ [0,v,w]	x,0,3/4 [0, \bar{v},w]	
2 b 2'2'	0,0,1/4 [0,0,w]	0,0,3/4 [0,0,w]	
2 a ..2/m	0,0,0 [0,0,w]	0,0,1/2 [0,0,w]	

Symmetry of special projections

Along [001] 2mm1'	Along [100] p2'mm'	Along [010] p2'mm'
Origin at 0,0,z	$a^* = c/2$ Origin at x,0,0	$a^* = c/2$ Origin at 0,y,0

$pcc'm'$

$mm'm'$

Orthorhombic

No. 21.5.108

$p2/c2'/c2'/m'$

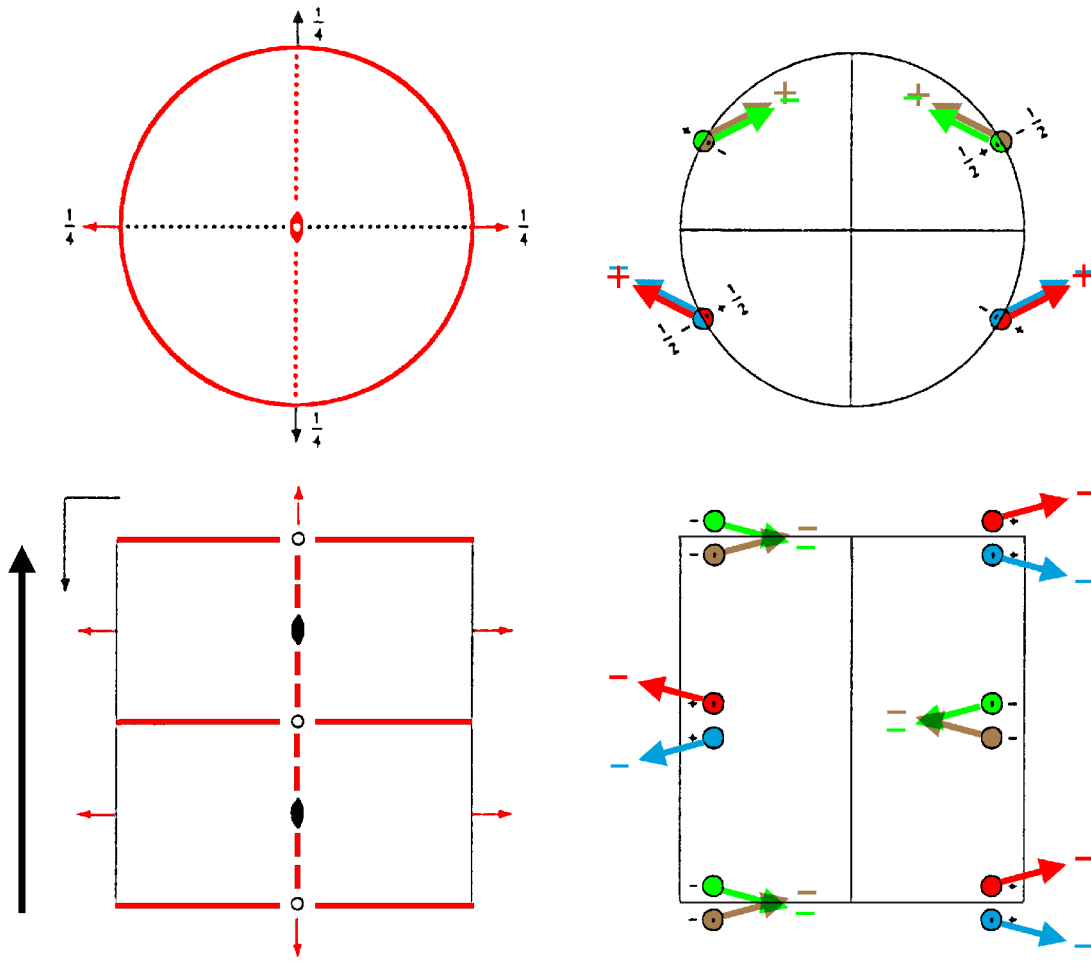

Origin at center ($2'/m'$) at $cc'2'/m'$

Asymmetric unit $0 \leq x$; $0 \leq y$; $0 \leq z \leq 1/2$

Symmetry operations

- | | | | |
|--|------------------------------------|--|--|
| (1) 1
(1 0,0,0) | (2) $2'$ 0,0,z
(2_z 0,0,0)' | (3) $2'$ 0,y, $1/4$
(2_y 0,0, $1/2$)' | (4) 2 x,0, $1/4$
(2_x 0,0, $1/2$) |
| (5) $\bar{1}$ 0,0,0
($\bar{1}$ 0,0,0) | (6) m' x,y,0
(m_z 0,0,0)' | (7) c' (0,0, $1/2$) x,0,z
(m_y 0,0, $1/2$)' | (8) c (0,0, $1/2$) 0,y,z
(m_x 0,0, $1/2$) |

Generators selected (1); t(0,0,1); (2); (3); (5)

Positions

	Coordinates		
Multiplicity, Wyckoff letter, Site symmetry			
8 g 1	(1) x,y,z [u,v,w]	(2) \bar{x},\bar{y},z [u,v, \bar{w}]	
	(3) $\bar{x},y,\bar{z}+1/2$ [u, \bar{v} ,w]	(4) x, $\bar{y},\bar{z}+1/2$ [u, \bar{v},\bar{w}]	
	(5) \bar{x},\bar{y},\bar{z} [u,v,w]	(6) x,y, \bar{z} [u,v, \bar{w}]	
	(7) x, $\bar{y},z+1/2$ [u, \bar{v} ,w]	(8) $\bar{x},y,z+1/2$ [u, \bar{v},\bar{w}]	
	4 f ..m'	x,y,0 [u,v,0]	$\bar{x},\bar{y},0$ [u,v,0]
		$\bar{x},y,1/2$ [u, \bar{v} ,0]	x, $\bar{y},1/2$ [u, \bar{v} ,0]
	4 e ..2'	0,0,z [u,v,0]	0,0, $\bar{z}+1/2$ [u, \bar{v} ,0]
		0,0, \bar{z} [u,v,0]	0,0,z+1/2 [u, \bar{v} ,0]
4 d .2'	0,y,1/4 [u,0,w]	0, $\bar{y},1/4$ [u,0, \bar{w}]	
	0, $\bar{y},3/4$ [u,0,w]	0,y,3/4 [u,0, \bar{w}]	
4 c 2..	x,0,1/4 [u,0,0]	$\bar{x},0,1/4$ [u,0,0]	
	$\bar{x},0,3/4$ [u,0,0]	x,0,3/4 [u,0,0]	
2 b 22'2'	0,0,1/4 [u,0,0]	0,0,3/4 [u,0,0]	
2 a ..2'/m'	0,0,0 [u,v,0]	0,0,1/2 [u, \bar{v} ,0]	

Symmetry of special projections

Along [001] 2'mm'	Along [100] $p_{2a^*}2mm$	Along [010] $p2'm'm$
Origin at 0,0,z	$a^* = c/2$ Origin at x,0,0	$a^* = c/2$ Origin at 0,y,0

$pccm'$

mmm'

Orthorhombic

No. 21.6.109

$p2'/c2'/c2'/m'$

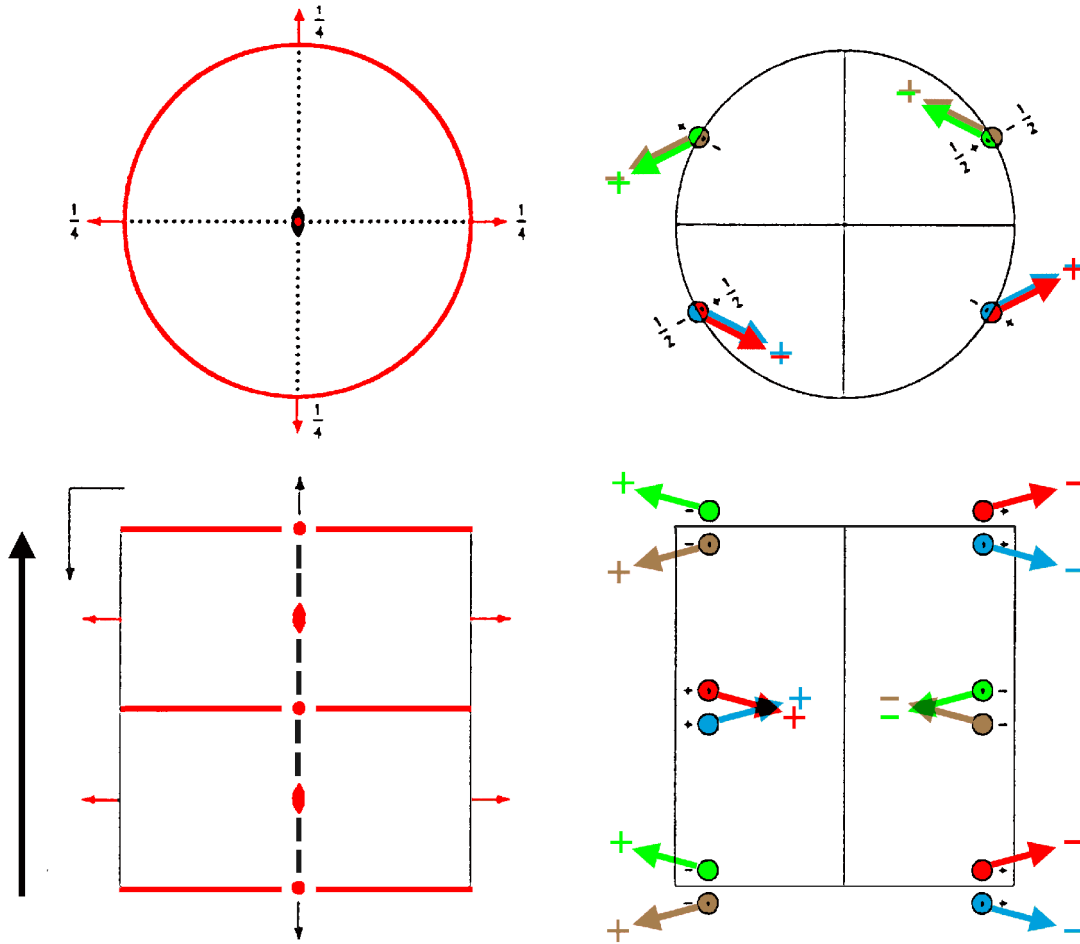

Origin at center ($2/m'$) at $cc2'/m'$

Asymmetric unit $0 \leq x$; $0 \leq y$; $0 \leq z \leq 1/2$

Symmetry operations

(1) 1
(1|0,0,0)

(2) $2_{0,0,z}$
(2_z |0,0,0)

(3) $2'_{0,y,1/4}$
(2_y |0,0,1/2)'

(4) $2'_{x,0,1/4}$
(2_x |0,0,1/2)'

(5) $\bar{1}'_{0,0,0}$
($\bar{1}$ |0,0,0)'

(6) m'_x
(m_z |0,0,0)'

(7) $c_{(0,0,1/2)}$
(m_y |0,0,1/2)

(8) $c_{(0,0,1/2)}$
(m_x |0,0,1/2)

Generators selected (1); $t(0,0,1)$; (2); (3); (5)

Positions

	Coordinates		
Multiplicity, Wyckoff letter, Site symmetry			
8 g 1	(1) x,y,z [u,v,w]	(2) \bar{x},\bar{y},z [\bar{u},\bar{v},w]	
	(3) $\bar{x},y,\bar{z}+1/2$ [u, \bar{v},w]	(4) $x,\bar{y},\bar{z}+1/2$ [\bar{u},v,w]	
	(5) \bar{x},\bar{y},\bar{z} [\bar{u},\bar{v},\bar{w}]	(6) x,y,\bar{z} [u,v, \bar{w}]	
	(7) $x,\bar{y},z+1/2$ [\bar{u},v,\bar{w}]	(8) $\bar{x},y,z+1/2$ [u, \bar{v},\bar{w}]	
	4 f ..m'	$x,y,0$ [u,v,0]	$\bar{x},\bar{y},0$ [$\bar{u},\bar{v},0$]
		$\bar{x},y,1/2$ [u, $\bar{v},0$]	$x,\bar{y},1/2$ [$\bar{u},v,0$]
	4 e ..2	$0,0,z$ [0,0,w]	$0,0,\bar{z}+1/2$ [0,0,w]
		$0,0,\bar{z}$ [0,0, \bar{w}]	$0,0,z+1/2$ [0,0, \bar{w}]
4 d .2'	$0,y,1/4$ [u,0,w]	$0,\bar{y},1/4$ [$\bar{u},0,w$]	
	$0,\bar{y},3/4$ [$\bar{u},0,\bar{w}$]	$0,y,3/4$ [u,0, \bar{w}]	
4 c 2'..	$x,0,1/4$ [0,v,w]	$\bar{x},0,1/4$ [0, \bar{v},w]	
	$\bar{x},0,3/4$ [0, \bar{v},\bar{w}]	$x,0,3/4$ [0,v, \bar{w}]	
2 b 2'2'2	$0,0,1/4$ [0,0,w]	$0,0,3/4$ [0,0, \bar{w}]	
2 a ..2/m'	$0,0,0$ [0,0,0]	$0,0,1/2$ [0,0,0]	

Symmetry of special projections

Along [001] 2mm	Along [100] $p_{2a^*}2m'm'$	Along [010] $p_{2a^*}2m'm'$
Origin at 0,0,z	$a^* = c/2$ Origin at x,0,0	$a^* = c/2$ Origin at 0,y,0

$pc'cm$

$m'mm$

Orthorhombic

No. 21.7.110

$p2/c'2'/c2'/m$

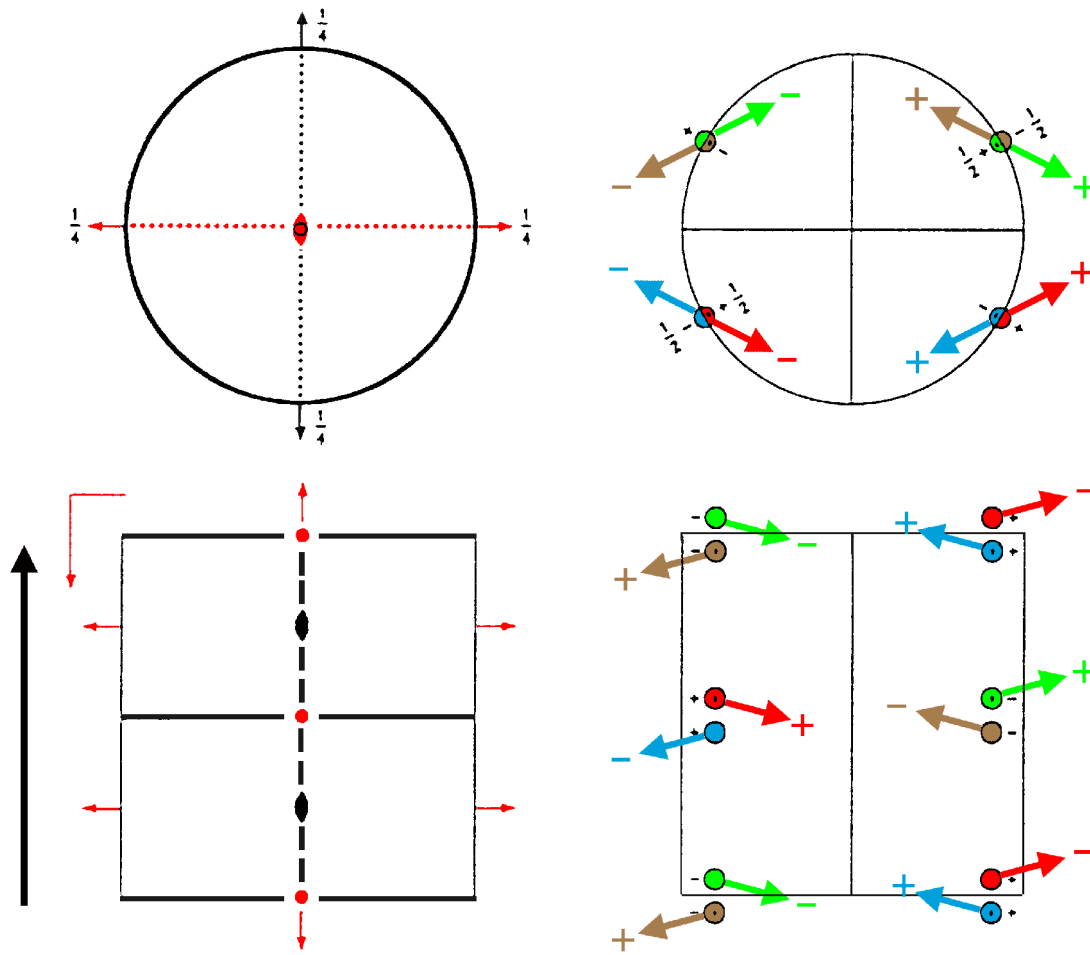

Origin at center ($2'/m$) at $c'c2'/m$

Asymmetric unit $0 \leq x$; $0 \leq y$; $0 \leq z \leq 1/2$

Symmetry operations

- | | | | |
|---|---------------------------------------|---|--|
| (1) 1
(1 0,0,0) | (2) $2'_z$ 0,0,z
($2'_z$ 0,0,0)' | (3) $2'_y$ 0,y, $1/4$
($2'_y$ 0,0, $1/2$)' | (4) $2'_x$ x,0, $1/4$
($2'_x$ 0,0, $1/2$)' |
| (5) $\bar{1}$ 0,0,0
($\bar{1}$ 0,0,0)' | (6) m x,y,0
(m_z 0,0,0) | (7) c (0,0, $1/2$) x,0,z
(m_y 0,0, $1/2$)' | (8) c'_z (0,0, $1/2$) 0,y,z
(m_x 0,0, $1/2$)' |

Generators selected (1); $t(0,0,1)$; (2); (3); (5)

Positions

	Coordinates		
Multiplicity, Wyckoff letter, Site symmetry			
8 g 1	(1) x,y,z [u,v,w]	(2) \bar{x},\bar{y},z [u,v, \bar{w}]	
	(3) $\bar{x},y,\bar{z}+1/2$ [u, \bar{v} ,w]	(4) $x,\bar{y},\bar{z}+1/2$ [u, \bar{v} , \bar{w}]	
	(5) \bar{x},\bar{y},\bar{z} [\bar{u} , \bar{v} , \bar{w}]	(6) x,y,\bar{z} [\bar{u} , \bar{v} ,w]	
	(7) $x,\bar{y},z+1/2$ [\bar{u} ,v, \bar{w}]	(8) $\bar{x},y,z+1/2$ [\bar{u} ,v,w]	
	4 f ..m	$x,y,0$ [0,0,w]	$\bar{x},\bar{y},0$ [0,0, \bar{w}]
		$\bar{x},y,1/2$ [0,0,w]	$x,\bar{y},1/2$ [0,0, \bar{w}]
	4 e ..2'	$0,0,z$ [u,v,0]	$0,0,\bar{z}+1/2$ [u, \bar{v} ,0]
		$0,0,\bar{z}$ [\bar{u} , \bar{v} ,0]	$0,0,z+1/2$ [\bar{u} ,v,0]
4 d ..2'	$0,y,1/4$ [u,0,w]	$0,\bar{y},1/4$ [u,0, \bar{w}]	
	$0,\bar{y},3/4$ [\bar{u} ,0, \bar{w}]	$0,y,3/4$ [\bar{u} ,0,w]	
4 c 2..	$x,0,1/4$ [u,0,0]	$\bar{x},0,1/4$ [\bar{u} ,0,0]	
	$\bar{x},0,3/4$ [u,0,0]	$x,0,3/4$ [\bar{u} ,0,0]	
2 b 22'2'	$0,0,1/4$ [u,0,0]	$0,0,3/4$ [\bar{u} ,0,0]	
2 a ..2'/m	$0,0,0$ [0,0,0]	$0,0,1/2$ [0,0,0]	

Symmetry of special projections

Along [001] $2mm1'$ Origin at 0,0,z	Along [100] $p2mm$ $a^* = c/2$ Origin at x,0,0	Along [010] $p_{2a^*}2mm$ $a^* = c/2$ Origin at 0,y,0
--	--	---

pmcm

mmm

Orthorhombic

No. 22.1.111

$p2/m2/c2_1/m$

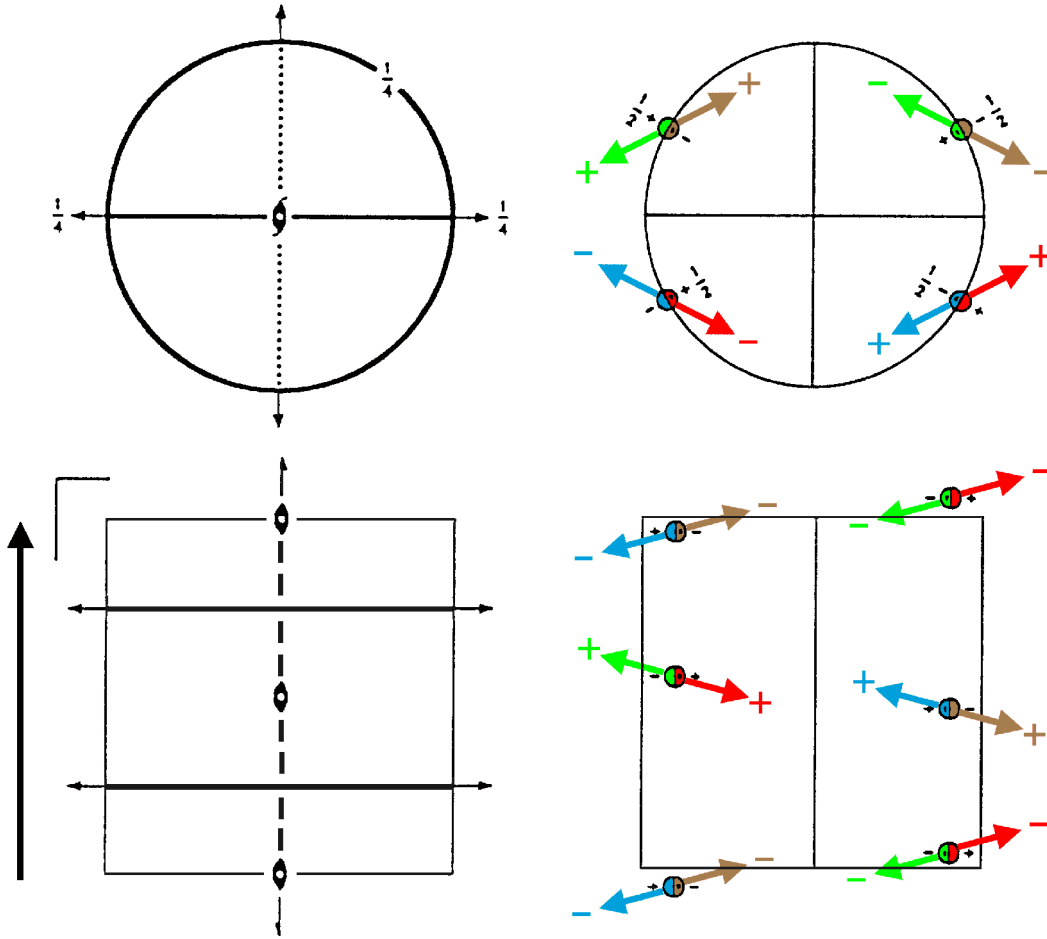

Origin at center ($2/m$) at $2/mc2_1$

Asymmetric unit $0 \leq x; 0 \leq z \leq 1/4$

Symmetry operations

- | | | | |
|--|--|----------------------------------|--|
| (1) 1
(1 0,0,0) | (2) 2 $0,y,1/4$
($2_y 0,0,1/2$) | (3) 2 $x,0,0$
($2_x 0,0,0$) | (4) 2 $(0,0,1/2)$ $0,0,z$
($2_z 0,0,1/2$) |
| (5) $\bar{1}$ $0,0,0$
($\bar{1} 0,0,0$) | (6) c $(0,0,1/2)$ $x,0,z$
($m_y 0,0,1/2$) | (7) m $0,y,z$
($m_x 0,0,0$) | (8) m $x,y,1/4$
($m_z 0,0,1/2$) |

Generators selected (1); $t(0,0,1)$; (2); (3); (5)

Positions

Multiplicity, Wyckoff letter, Site symmetry	Coordinates		
8 f 1	(1) x,y,z [u,v,w]	(2) $\bar{x},y,\bar{z}+1/2$ [\bar{u},v,\bar{w}]	
	(3) x,\bar{y},\bar{z} [u, \bar{v},\bar{w}]	(4) $\bar{x},\bar{y},z+1/2$ [\bar{u},\bar{v},w]	
	(5) \bar{x},\bar{y},\bar{z} [u,v,w]	(6) $x,\bar{y},z+1/2$ [\bar{u},v,\bar{w}]	
	(7) \bar{x},y,z [u, \bar{v},\bar{w}]	(8) $x,y,\bar{z}+1/2$ [\bar{u},\bar{v},w]	
	4 e ..m	$x,y,1/4$ [0,0,w]	$\bar{x},y,1/4$ [0,0, \bar{w}]
		$x,\bar{y},3/4$ [0,0, \bar{w}]	$\bar{x},\bar{y},3/4$ [0,0,w]
	4 d m..	$0,y,z$ [u,0,0]	$0,y,\bar{z}+1/2$ [$\bar{u},0,0$]
		$0,\bar{y},\bar{z}$ [u,0,0]	$0,\bar{y},z+1/2$ [$\bar{u},0,0$]
4 c 2..	$x,0,0$ [u,0,0]	$\bar{x},0,1/2$ [$\bar{u},0,0$]	
	$\bar{x},0,0$ [u,0,0]	$x,0,1/2$ [$\bar{u},0,0$]	
2 b m2m	$0,y,1/4$ [0,0,0]	$0,\bar{y},3/4$ [0,0,0]	
2 a 2/m..	$0,0,0$ [u,0,0]	$0,0,1/2$ [$\bar{u},0,0$]	

Symmetry of special projections

Along [001] $2mm1'$	Along [100] $p2mg1'$	Along [010] $p_{2a^*}2mm$
Origin at 0,0,z	$a^* = c$ Origin at x,0,0	$a^* = c/2$ Origin at 0,y,1/4

pmcm1'

mmm1'

Orthorhombic

No. 22.2.112

p2/m2/c2₁/m1'

1'

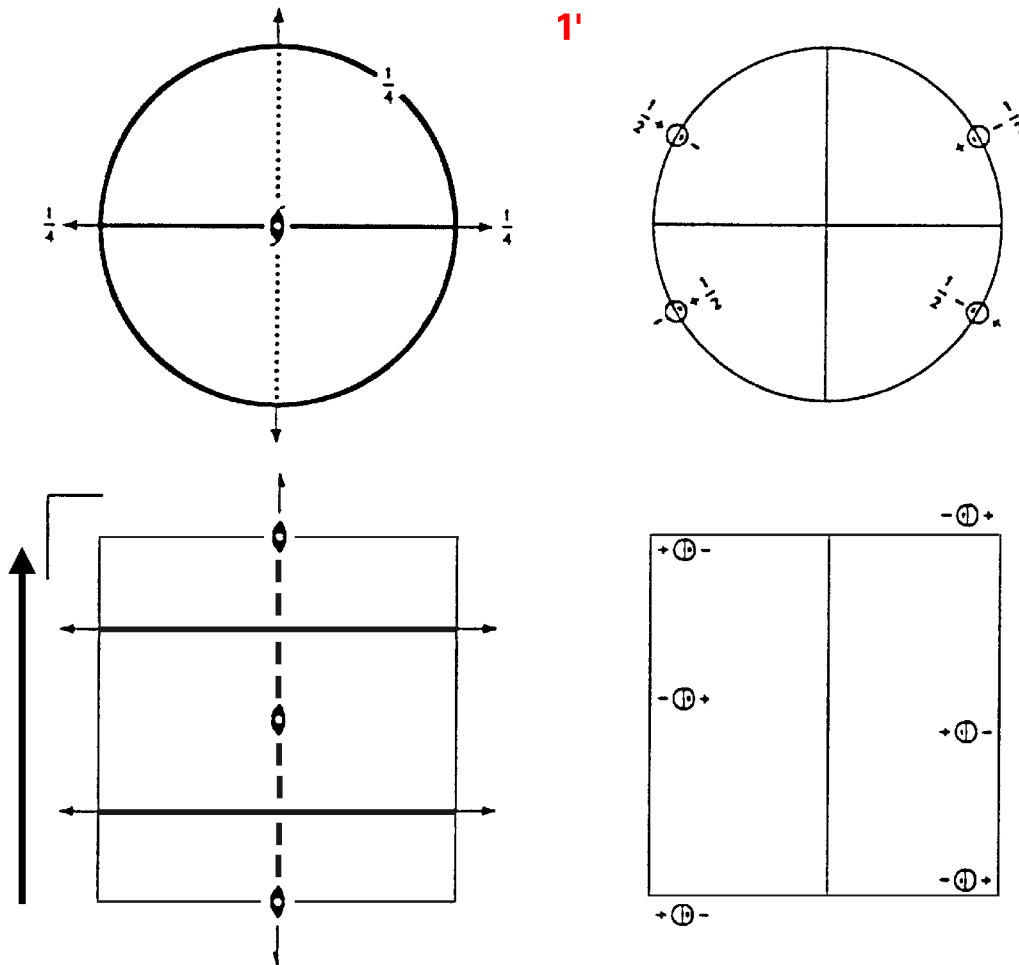

Origin at center (2/m1') at 2/mc2₁1'

Asymmetric unit $0 \leq x; 0 \leq z \leq 1/4$

Symmetry operations

For 1 + set

- | | | | |
|--|---|---|--|
| (1) 1
(1 0,0,0) | (2) 2 _y 0,y,1/4
(2 _y 0,0,1/2) | (3) 2 _x x,0,0
(2 _x 0,0,0) | (4) 2 (0,0,1/2) 0,0,z
(2 _z 0,0,1/2) |
| (5) $\bar{1}$ 0,0,0
($\bar{1}$ 0,0,0) | (6) c (0,0,1/2) x,0,z
(m _y 0,0,1/2) | (7) m 0,y,z
(m _x 0,0,0) | (8) m x,y,1/4
(m _z 0,0,1/2) |

For 1' + set

- | | | | |
|--|--|--|---|
| (1) 1'
(1 0,0,0)' | (2) 2' _y 0,y,1/4
(2' _y 0,0,1/2)' | (3) 2' _x x,0,0
(2' _x 0,0,0)' | (4) 2' (0,0,1/2) 0,0,z
(2' _z 0,0,1/2)' |
| (5) $\bar{1}$ ' 0,0,0
($\bar{1}$ ' 0,0,0)' | (6) c' (0,0,1/2) x,0,z
(m' _y 0,0,1/2)' | (7) m' 0,y,z
(m' _x 0,0,0)' | (8) m' x,y,1/4
(m' _z 0,0,1/2)' |

Generators selected (1); t(0,0,1); (2); (3); (5); 1'

Positions

Multiplicity, Wyckoff letter, Site symmetry	Coordinates	
	1+	1' +
8 f 11'	(1) x,y,z [0,0,0]	(2) $\bar{x},y,\bar{z}+1/2$ [0,0,0]
	(3) x,\bar{y},\bar{z} [0,0,0]	(4) $\bar{x},\bar{y},z+1/2$ [0,0,0]
	(5) \bar{x},\bar{y},\bar{z} [0,0,0]	(6) $x,\bar{y},z+1/2$ [0,0,0]
	(7) \bar{x},y,z [0,0,0]	(8) $x,y,\bar{z}+1/2$ [0,0,0]
4 e ..m1'	x,y,1/4 [0,0,0]	$\bar{x},y,1/4$ [0,0,0]
	$x,\bar{y},3/4$ [0,0,0]	$\bar{x},\bar{y},3/4$ [0,0,0]
4 d m..1'	0,y,z [0,0,0]	0,y, $\bar{z}+1/2$ [0,0,0]
	0, \bar{y},\bar{z} [0,0,0]	0, $\bar{y},z+1/2$ [0,0,0]
4 c 2..1'	x,0,0 [0,0,0]	$\bar{x},0,1/2$ [0,0,0]
	$\bar{x},0,0$ [0,0,0]	x,0,1/2 [0,0,0]
2 b m2m1'	0,y,1/4 [0,0,0]	0, $\bar{y},3/4$ [0,0,0]
2 a 2/m..1'	0,0,0 [0,0,0]	0,0,1/2 [0,0,0]

Symmetry of special projections

Along [001] 2mm1'	Along [100] p2mg1'	Along [010] p2mm1'
Origin at 0,0,z	$a^* = c$ Origin at x,0,0	$a^* = c/2$ Origin at 0,y,0

$pm'c'm'$

$m'm'm'$

Orthorhombic

No. 22.3.113

$p2/m'2/c'2_1/m'$

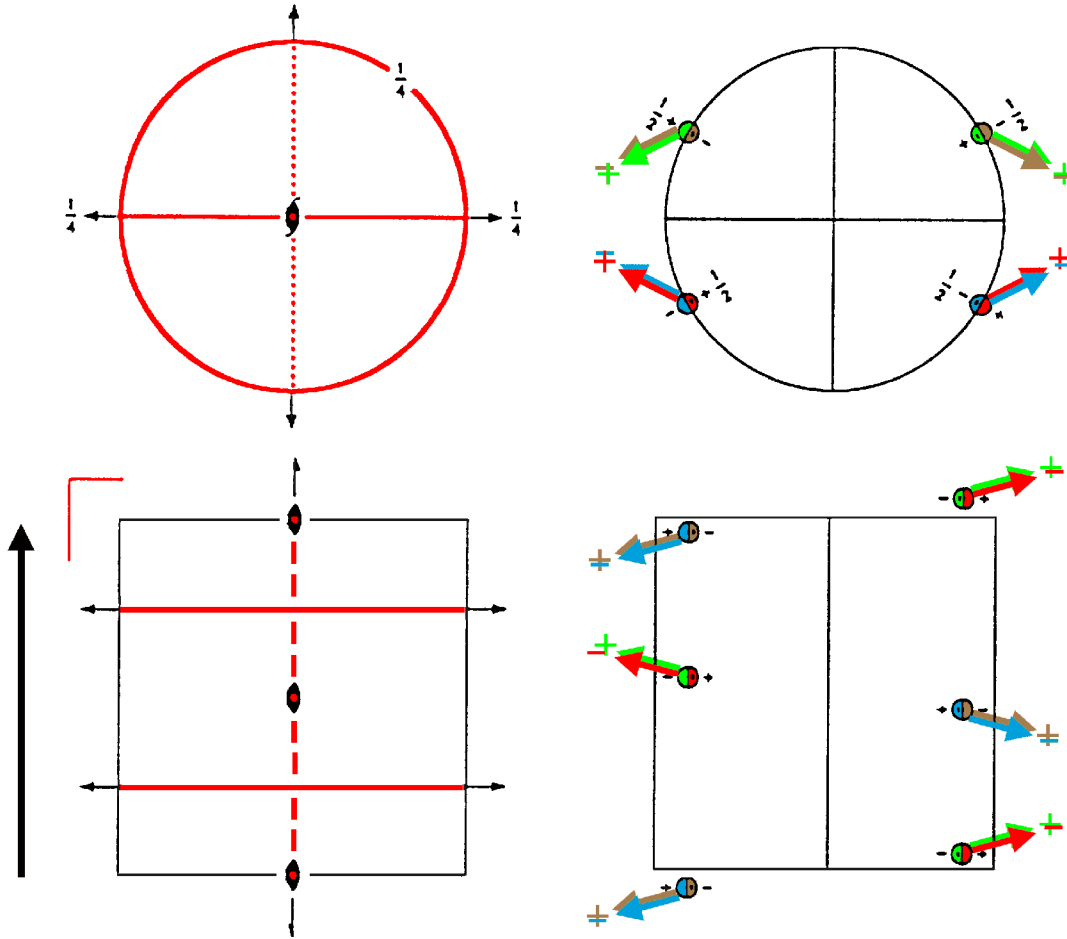

Origin at center ($2/m'$) at $2/m'c'2_1$

Asymmetric unit $0 \leq x; 0 \leq z \leq 1/4$

Symmetry operations

- | | | | |
|--|---|------------------------------------|--|
| (1) 1
(1 0,0,0) | (2) $2_{0,y,1/4}$
(2_y 0,0,1/2) | (3) $2_{x,0,0}$
(2_x 0,0,0) | (4) $2_{(0,0,1/2)}$ 0,0,z
(2_z 0,0,1/2) |
| (5) $\bar{1}$ 0,0,0
($\bar{1}$ 0,0,0) | (6) c' (0,0,1/2) x,0,z
(m_y 0,0,1/2) | (7) m' 0,y,z
(m_x 0,0,0) | (8) m' x,y,1/4
(m_z 0,0,1/2) |

Generators selected (1); t(0,0,1); (2); (3); (5)

Positions

Multiplicity, Wyckoff letter, Site symmetry	Coordinates		
8 f 1	(1) x,y,z [u,v,w]	(2) $\bar{x},y,\bar{z}+1/2$ [\bar{u},v,\bar{w}]	
	(3) x,\bar{y},\bar{z} [u, \bar{v},\bar{w}]	(4) $\bar{x},\bar{y},z+1/2$ [\bar{u},\bar{v},w]	
	(5) \bar{x},\bar{y},\bar{z} [\bar{u},\bar{v},\bar{w}]	(6) $x,\bar{y},z+1/2$ [u, \bar{v},w]	
	(7) \bar{x},y,z [\bar{u},v,w]	(8) $x,y,\bar{z}+1/2$ [u,v, \bar{w}]	
	4 e ..m'	$x,y,1/4$ [u,v,0]	$\bar{x},y,1/4$ [$\bar{u},v,0$]
		$x,\bar{y},3/4$ [u, $\bar{v},0$]	$\bar{x},\bar{y},3/4$ [$\bar{u},\bar{v},0$]
	4 d m'..	$0,y,z$ [0,v,w]	$0,y,\bar{z}+1/2$ [0,v, \bar{w}]
		$0,\bar{y},\bar{z}$ [0, \bar{v},\bar{w}]	$0,\bar{y},z+1/2$ [0, \bar{v},w]
4 c 2..	$x,0,0$ [u,0,0]	$\bar{x},0,1/2$ [$\bar{u},0,0$]	
	$\bar{x},0,0$ [$\bar{u},0,0$]	$x,0,1/2$ [u,0,0]	
2 b m'2m'	$0,y,1/4$ [0,v,0]	$0,\bar{y},3/4$ [0, $\bar{v},0$]	
2 a 2/m'..	$0,0,0$ [0,0,0]	$0,0,1/2$ [0,0,0]	

Symmetry of special projections

Along [001] 2m'm'	Along [100] p2m'g'	Along [010] p2m'm'
Origin at 0,0,z	$a^* = c$ Origin at x,0,0	$a^* = c/2$ Origin at 0,y,0

$pm'cm'$

$m'mm'$

Orthorhombic

No. 22.4.114

$p2'/m'2/c2_1'/m'$

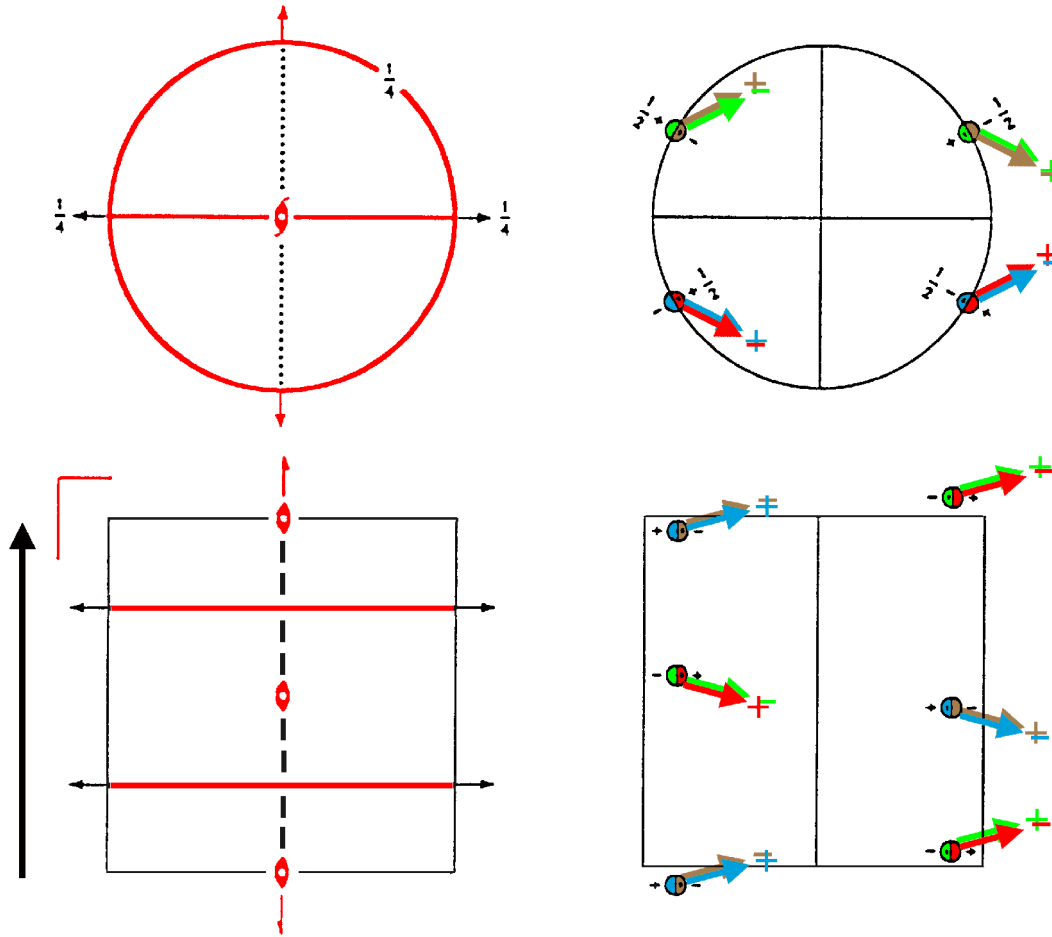

Origin at center ($2'/m'$) at $2'/m'c2_1'$

Asymmetric unit $0 \leq x$; $0 \leq z \leq 1/4$

Symmetry operations

- | | | | |
|--|--|------------------------------------|--|
| (1) 1
(1 0,0,0) | (2) 2 $0,y,1/4$
($2_y 0,0,1/2$) | (3) $2' x,0,0$
($2_x 0,0,0$)' | (4) $2' (0,0,1/2) 0,0,z$
($2_z 0,0,1/2$)' |
| (5) $\bar{1} 0,0,0$
($\bar{1} 0,0,0$) | (6) c ($0,0,1/2$) $x,0,z$
($m_y 0,0,1/2$) | (7) $m' 0,y,z$
($m_x 0,0,0$)' | (8) $m' x,y,1/4$
($m_z 0,0,1/2$)' |

Generators selected (1); t(0,0,1); (2); (3); (5)

Positions

	Coordinates		
Multiplicity, Wyckoff letter, Site symmetry			
8 f 1	(1) x,y,z [u,v,w]	(2) $\bar{x},y,\bar{z}+1/2$ [\bar{u},v,\bar{w}]	
	(3) x,\bar{y},\bar{z} [\bar{u},v,w]	(4) $\bar{x},\bar{y},z+1/2$ [u,v,\bar{w}]	
	(5) \bar{x},\bar{y},\bar{z} [u,v,w]	(6) $x,\bar{y},z+1/2$ [\bar{u},v,\bar{w}]	
	(7) \bar{x},y,z [\bar{u},v,w]	(8) $x,y,\bar{z}+1/2$ [u,v,\bar{w}]	
	4 e ..m'	x,y,1/4 [u,v,0]	$\bar{x},y,1/4$ [$\bar{u},v,0$]
		$x,\bar{y},3/4$ [$\bar{u},v,0$]	$\bar{x},\bar{y},3/4$ [$u,v,0$]
	4 d m'..	0,y,z [0,v,w]	$0,y,\bar{z}+1/2$ [0,v, \bar{w}]
		$0,\bar{y},\bar{z}$ [0,v,w]	$0,\bar{y},z+1/2$ [0,v, \bar{w}]
4 c 2'..	x,0,0 [0,v,w]	$\bar{x},0,1/2$ [0,v, \bar{w}]	
	$\bar{x},0,0$ [0,v,w]	x,0,1/2 [0,v, \bar{w}]	
2 b m'2m'	0,y,1/4 [0,v,0]	$0,\bar{y},3/4$ [0,v,0]	
2 a 2'/m'..	0,0,0 [0,v,w]	0,0,1/2 [0,v, \bar{w}]	

Symmetry of special projections

Along [001] 2'm'm	Along [100] p2mg $a^* = c$	Along [010] $p_{2a^*} 2m'm'$ $a^* = c/2$
Origin at 0,0,z	Origin at x,0,0	Origin at 0,y,1/4

$pmc'm'$

$mm'm'$

Orthorhombic

No. 22.5.115

$p2/m2'/c'2_1'/m'$

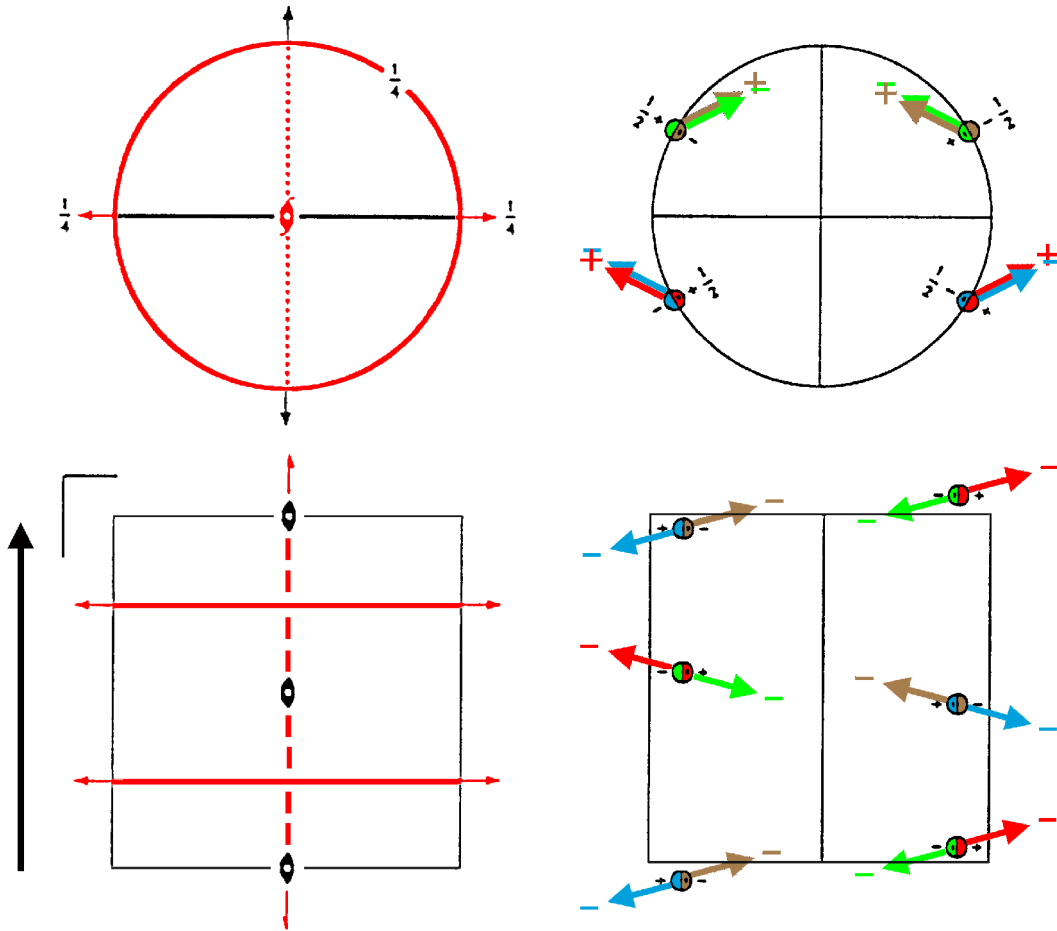

Origin at center ($2/m$) at $2/mc'2_1'$

Asymmetric unit $0 \leq x$; $0 \leq z \leq 1/4$

Symmetry operations

- | | | | |
|--|--|----------------------------------|--|
| (1) 1
(1 0,0,0) | (2) $2'_y$ 0,y,1/4
(2_y 0,0,1/2)' | (3) 2 $x,0,0$
(2_x 0,0,0) | (4) $2'_z$ (0,0,1/2) 0,0,z
(2_z 0,0,1/2)' |
| (5) $\bar{1}$ 0,0,0
($\bar{1}$ 0,0,0) | (6) c'_x (0,0,1/2) x,0,z
(m_y 0,0,1/2)' | (7) m 0,y,z
(m_x 0,0,0) | (8) m'_y x,y,1/4
(m_z 0,0,1/2)' |

Generators selected (1); t(0,0,1); (2); (3); (5)

Positions

Multiplicity, Wyckoff letter, Site symmetry	Coordinates		
8 f 1	(1) x,y,z [u,v,w]	(2) $\bar{x},y,\bar{z}+1/2$ [u, \bar{v} ,w]	
	(3) x,\bar{y},\bar{z} [u, \bar{v} , \bar{w}]	(4) $\bar{x},\bar{y},z+1/2$ [u,v, \bar{w}]	
	(5) \bar{x},\bar{y},\bar{z} [u,v,w]	(6) $x,\bar{y},z+1/2$ [u, \bar{v} ,w]	
	(7) \bar{x},y,z [u, \bar{v} , \bar{w}]	(8) $x,y,\bar{z}+1/2$ [u,v, \bar{w}]	
	4 e ..m'	$x,y,1/4$ [u,v,0]	$\bar{x},y,1/4$ [u, \bar{v} ,0]
		$x,\bar{y},3/4$ [u, \bar{v} ,0]	$\bar{x},\bar{y},3/4$ [u,v,0]
	4 d m..	$0,y,z$ [u,0,0]	$0,y,\bar{z}+1/2$ [u,0,0]
		$0,\bar{y},\bar{z}$ [u,0,0]	$0,\bar{y},z+1/2$ [u,0,0]
4 c 2..	$x,0,0$ [u,0,0]	$\bar{x},0,1/2$ [u,0,0]	
	$\bar{x},0,0$ [u,0,0]	$x,0,1/2$ [u,0,0]	
2 b m2'm'	$0,y,1/4$ [u,0,0]	$0,\bar{y},3/4$ [u,0,0]	
2 a 2/m..	$0,0,0$ [u,0,0]	$0,0,1/2$ [u,0,0]	

Symmetry of special projections

Along [001] 2'mm'	Along [100] p2mg1'	Along [010] p2'm'm
Origin at 0,0,z	$\mathbf{a}^* = \mathbf{c}$ Origin at x,0,0	$\mathbf{a}^* = \mathbf{c}/2$ Origin at 0,y,0

$pm'c'm$

$m'm'm$

Orthorhombic

No. 22.6.116

$p2'/m'2'/c'2_1/m$

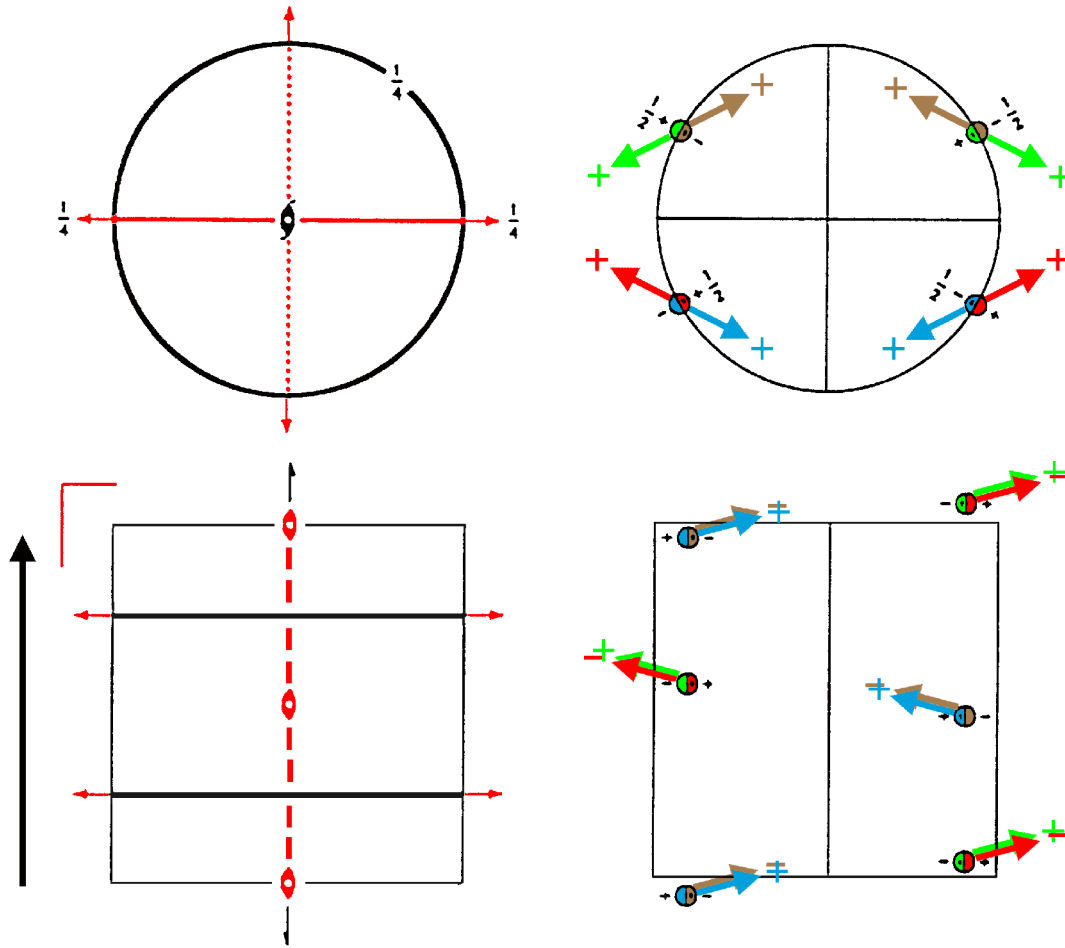

Origin at center ($2'/m'$) at $2'/m'c'2_1$

Asymmetric unit $0 \leq x$; $0 \leq z \leq 1/4$

Symmetry operations

- | | | | |
|--|--|--------------------------------------|--|
| (1) 1
(1 0,0,0) | (2) $2'$ $0,y,1/4$
($2_y 0,0,1/2$)' | (3) $2'$ $x,0,0$
($2_x 0,0,0$)' | (4) 2 $(0,0,1/2)$ $0,0,z$
($2_z 0,0,1/2$) |
| (5) $\bar{1}$ $0,0,0$
($\bar{1} 0,0,0$) | (6) c' $(0,0,1/2)$ $x,0,z$
($m_y 0,0,1/2$)' | (7) m' $0,y,z$
($m_x 0,0,0$)' | (8) m $x,y,1/4$
($m_z 0,0,1/2$) |

Generators selected (1); t(0,0,1); (2); (3); (5)

Positions

	Coordinates		
Multiplicity, Wyckoff letter, Site symmetry			
8 f 1	(1) x,y,z [u,v,w]	(2) $\bar{x},y,\bar{z}+1/2$ [u, \bar{v} ,w]	
	(3) x, \bar{y},\bar{z} [\bar{u} ,v,w]	(4) $\bar{x},\bar{y},z+1/2$ [\bar{u} , \bar{v} ,w]	
	(5) \bar{x},\bar{y},\bar{z} [u,v,w]	(6) x, $\bar{y},z+1/2$ [u, \bar{v} ,w]	
	(7) \bar{x},y,z [\bar{u} ,v,w]	(8) x,y, $\bar{z}+1/2$ [\bar{u} , \bar{v} ,w]	
	4 e ..m	x,y,1/4 [0,0,w]	$\bar{x},y,1/4$ [0,0,w]
		x, $\bar{y},3/4$ [0,0,w]	$\bar{x},\bar{y},3/4$ [0,0,w]
	4 d m'..	0,y,z [0,v,w]	0,y, $\bar{z}+1/2$ [0, \bar{v} ,w]
		0, \bar{y},\bar{z} [0,v,w]	0, $\bar{y},z+1/2$ [0, \bar{v} ,w]
4 c 2'..	x,0,0 [0,v,w]	$\bar{x},0,1/2$ [0, \bar{v} ,w]	
	$\bar{x},0,0$ [0,v, \bar{w}]	x,0,1/2 [0, \bar{v} ,w]	
2 b m'2'm	0,y,1/4 [0,0,w]	0, $\bar{y},3/4$ [0,0,w]	
2 a 2'/m'..	0,0,0 [0,v,w]	0,0,1/2 [0, \bar{v} ,w]	

Symmetry of special projections

Along [001] 2m'm'	Along [100] p2'mg'	Along [010] p2'mm'
Origin at 0,0,z	$\mathbf{a}^* = \mathbf{c}$ Origin at x,0,0	$\mathbf{a}^* = \mathbf{c}/2$ Origin at 0,y,0

$pmc'm$

$mm'm$

Orthorhombic

No. 22.7.117

$p2'm2/c'2_1'/m$

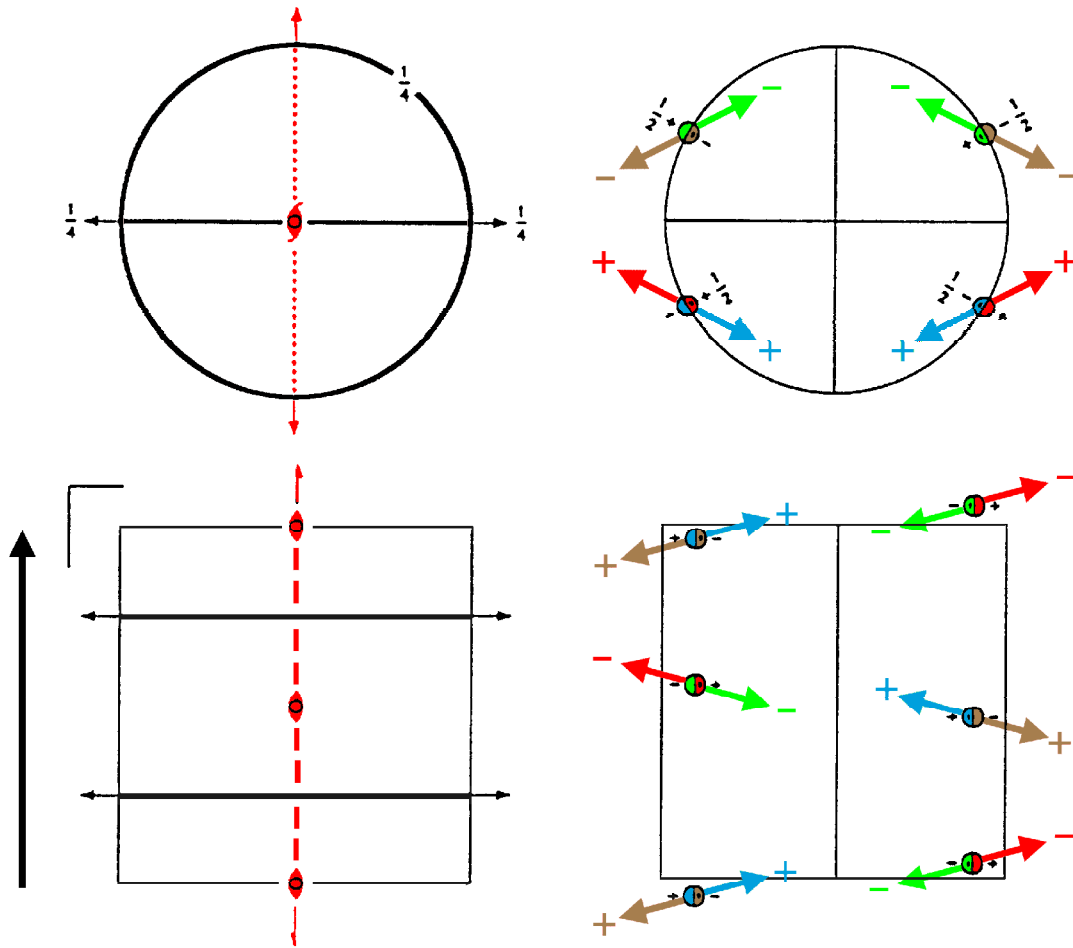

Origin at center ($2'/m$) at $2'/mc'2_1'$

Asymmetric unit $0 \leq x$; $0 \leq z \leq 1/4$

Symmetry operations

- | | | | |
|---|--|--|--|
| (1) 1
(1 0,0,0) | (2) 2 $0,y,1/4$
($2_y 0,0,1/2$) | (3) $2'_x$ $x,0,0$
($2_x 0,0,0$)' | (4) $2'_z$ $(0,0,1/2)$ $0,0,z$
($2_z 0,0,1/2$)' |
| (5) $\bar{1}$ $0,0,0$
($\bar{1} 0,0,0$)' | (6) c'_z $(0,0,1/2)$ $x,0,z$
($m_y 0,0,1/2$)' | (7) m $0,y,z$
($m_x 0,0,0$) | (8) m $x,y,1/4$
($m_z 0,0,1/2$) |

Generators selected (1); t(0,0,1); (2); (3); (5)

Positions

Multiplicity, Wyckoff letter, Site symmetry	Coordinates		
8 f 1	(1) x,y,z [u,v,w]	(2) $\bar{x},y,\bar{z}+1/2$ [\bar{u},v,\bar{w}]	
	(3) x,\bar{y},\bar{z} [\bar{u},v,w]	(4) $\bar{x},\bar{y},z+1/2$ [u,v, \bar{w}]	
	(5) \bar{x},\bar{y},\bar{z} [\bar{u},\bar{v},\bar{w}]	(6) $x,\bar{y},z+1/2$ [u, \bar{v},w]	
	(7) \bar{x},y,z [u, \bar{v},\bar{w}]	(8) $x,y,\bar{z}+1/2$ [\bar{u},\bar{v},w]	
	4 e ..m	$x,y,1/4$ [0,0,w]	$\bar{x},y,1/4$ [0,0, \bar{w}]
		$x,\bar{y},3/4$ [0,0,w]	$\bar{x},\bar{y},3/4$ [0,0, \bar{w}]
	4 d m..	$0,y,z$ [u,0,0]	$0,y,\bar{z}+1/2$ [$\bar{u},0,0$]
		$0,\bar{y},\bar{z}$ [$\bar{u},0,0$]	$0,\bar{y},z+1/2$ [u,0,0]
4 c 2'..	$x,0,0$ [0,v,w]	$\bar{x},0,1/2$ [0,v, \bar{w}]	
	$\bar{x},0,0$ [0, \bar{v},\bar{w}]	$x,0,1/2$ [0, \bar{v},w]	
2 b m2m	$0,y,1/4$ [0,0,0]	$0,\bar{y},3/4$ [0,0,0]	
2 a 2'/m..	$0,0,0$ [0,0,0]	$0,0,1/2$ [0,0,0]	

Symmetry of special projections

Along [001] 2mm1'	Along [100] p2mg1'	Along [010] p2mm
Origin at 0,0,z	$\mathbf{a}^* = \mathbf{c}$ Origin at x,0,0	$\mathbf{a}^* = \mathbf{c}/2$ Origin at 0,y,0

pm'cm

m'mm

Orthorhombic

No. 22.8.118

$p2/m'2'/c2_1'/m$

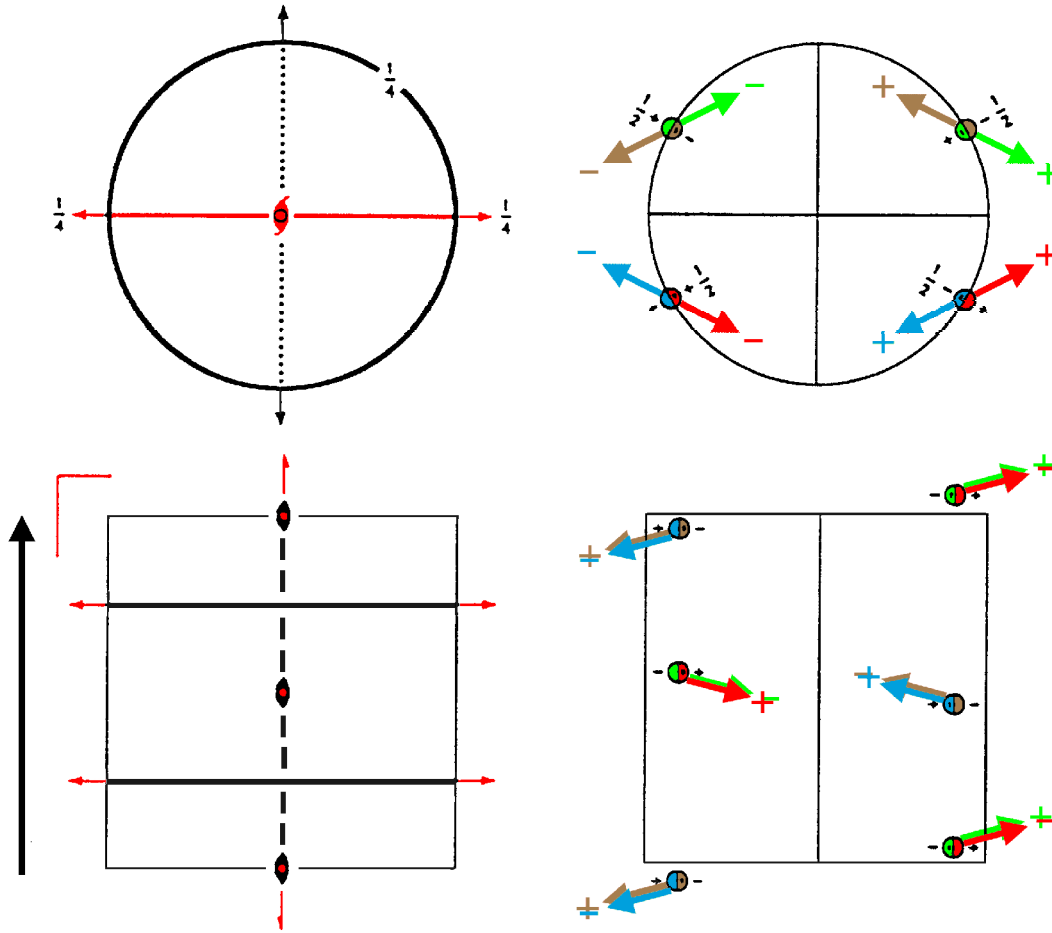

Origin at center ($2/m'$) at $2/m'c2_1'$

Asymmetric unit $0 \leq x; 0 \leq z \leq 1/4$

Symmetry operations

- | | | | |
|---|--|--------------------------------------|--|
| (1) 1
(1 0,0,0) | (2) $2'$ $0,y,1/4$
($2_y 0,0,1/2$)' | (3) 2 $x,0,0$
($2_x 0,0,0$) | (4) $2'$ $(0,0,1/2)$ $0,0,z$
($2_z 0,0,1/2$)' |
| (5) $\bar{1}$ $0,0,0$
($\bar{1} 0,0,0$)' | (6) c $(0,0,1/2)$ $x,0,z$
($m_y 0,0,1/2$) | (7) m' $0,y,z$
($m_x 0,0,0$)' | (8) m $x,y,1/4$
($m_z 0,0,1/2$) |

Generators selected (1); t(0,0,1); (2); (3); (5)

Positions

Multiplicity, Wyckoff letter, Site symmetry	Coordinates		
8 f 1	(1) x,y,z [u,v,w]	(2) $\bar{x},y,\bar{z}+1/2$ [u, \bar{v} ,w]	
	(3) x,\bar{y},\bar{z} [u, \bar{v} , \bar{w}]	(4) $\bar{x},\bar{y},z+1/2$ [u,v, \bar{w}]	
	(5) \bar{x},\bar{y},\bar{z} [\bar{u} , \bar{v} , \bar{w}]	(6) $x,\bar{y},z+1/2$ [\bar{u} ,v, \bar{w}]	
	(7) \bar{x},y,z [\bar{u} ,v,w]	(8) $x,y,\bar{z}+1/2$ [\bar{u} , \bar{v} ,w]	
	4 e ..m	$x,y,1/4$ [0,0,w]	$\bar{x},y,1/4$ [0,0,w]
		$x,\bar{y},3/4$ [0,0, \bar{w}]	$\bar{x},\bar{y},3/4$ [0,0, \bar{w}]
	4 d m'..	$0,y,z$ [0,v,w]	$0,y,\bar{z}+1/2$ [0, \bar{v} ,w]
		$0,\bar{y},\bar{z}$ [0, \bar{v} , \bar{w}]	$0,\bar{y},z+1/2$ [0,v, \bar{w}]
4 c 2..	$x,0,0$ [u,0,0]	$\bar{x},0,1/2$ [u,0,0]	
	$\bar{x},0,0$ [\bar{u} ,0,0]	$x,0,1/2$ [\bar{u} ,0,0]	
2 b m'2'm	$0,y,1/4$ [0,0,w]	$0,\bar{y},3/4$ [0,0, \bar{w}]	
2 a 2'/m..	$0,0,0$ [0,0,0]	$0,0,1/2$ [0,0,0]	

Symmetry of special projections

Along [001] 2mm1'	Along [100] p2mg $\mathbf{a}^* = \mathbf{c}$	Along [010] $p_{2a^*} 2m'm'$ $\mathbf{a}^* = \mathbf{c}/2$
Origin at 0,0,z	Origin at x,0,0	Origin at 0,y,0

$pmcm'$

mmm'

Orthorhombic

No. 22.9.119

$p2'/m2'/c2_1/m'$

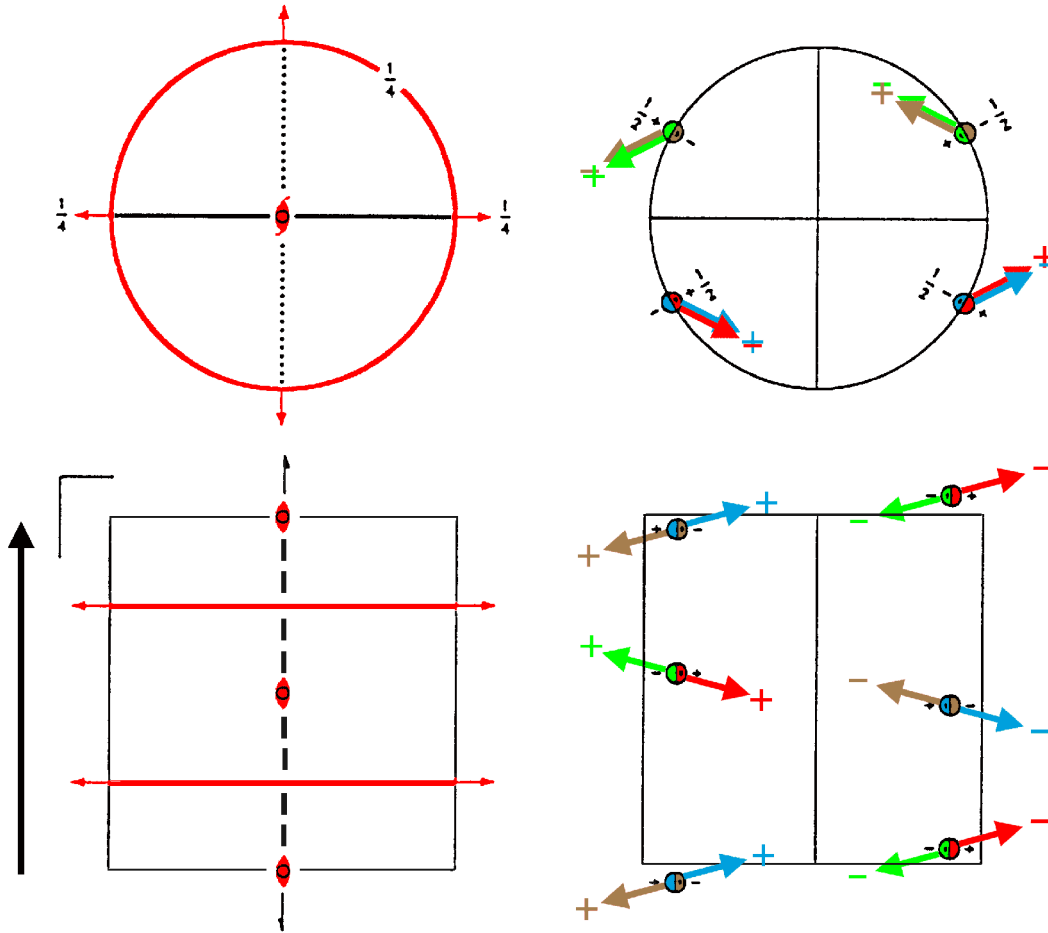

Origin at center ($2'/m$) at $2'/mc2_1$

Asymmetric unit $0 \leq x; 0 \leq z \leq 1/4$

Symmetry operations

- | | | | |
|---|--|--------------------------------------|--|
| (1) 1
(1 0,0,0) | (2) $2'$ $0,y,1/4$
($2_y 0,0,1/2$)' | (3) $2'$ $x,0,0$
($2_x 0,0,0$)' | (4) 2 $(0,0,1/2)$ $0,0,z$
($2_z 0,0,1/2$) |
| (5) $\bar{1}$ $0,0,0$
($\bar{1} 0,0,0$)' | (6) c $(0,0,1/2)$ $x,0,z$
($m_y 0,0,1/2$) | (7) m $0,y,z$
($m_x 0,0,0$) | (8) m' $x,y,1/4$
($m_z 0,0,1/2$)' |

Generators selected (1); t(0,0,1); (2); (3); (5)

Positions

	Coordinates		
Multiplicity, Wyckoff letter, Site symmetry			
8 f 1	(1) x,y,z [u,v,w]	(2) $\bar{x},y,\bar{z}+1/2$ [u, \bar{v} ,w]	
	(3) x, \bar{y},\bar{z} [\bar{u} ,v,w]	(4) $\bar{x},\bar{y},z+1/2$ [\bar{u} , \bar{v} ,w]	
	(5) \bar{x},\bar{y},\bar{z} [\bar{u} , \bar{v} , \bar{w}]	(6) x, $\bar{y},z+1/2$ [\bar{u} ,v, \bar{w}]	
	(7) \bar{x},y,z [u, \bar{v} , \bar{w}]	(8) x,y, $\bar{z}+1/2$ [u,v, \bar{w}]	
	4 e ..m'	x,y,1/4 [u,v,0]	$\bar{x},y,1/4$ [u, \bar{v} ,0]
		x, $\bar{y},3/4$ [\bar{u} ,v,0]	$\bar{x},\bar{y},3/4$ [\bar{u} , \bar{v} ,0]
	4 d m..	0,y,z [u,0,0]	0,y, $\bar{z}+1/2$ [u,0,0]
		0, \bar{y},\bar{z} [\bar{u} ,0,0]	0, $\bar{y},z+1/2$ [\bar{u} ,0,0]
4 c 2'..	x,0,0 [0,v,w]	$\bar{x},0,1/2$ [0, \bar{v} ,w]	
	$\bar{x},0,0$ [0, \bar{v} , \bar{w}]	x,0,1/2 [0,v, \bar{w}]	
2 b m2'm'	0,y,1/4 [u,0,0]	0, $\bar{y},3/4$ [\bar{u} ,0,0]	
2 a 2'/m..	0,0,0 [0,0,0]	0,0,1/2 [0,0,0]	

Symmetry of special projections

Along [001] 2mm	Along [100] p2mg1'	Along [010] p _{2a*} 2mm
Origin at 0,0,z	a* = c Origin at x,0,0	a* = c/2 Origin at 0,y,0

$p4$

4

Tetragonal

No. 23.1.120

$p4$

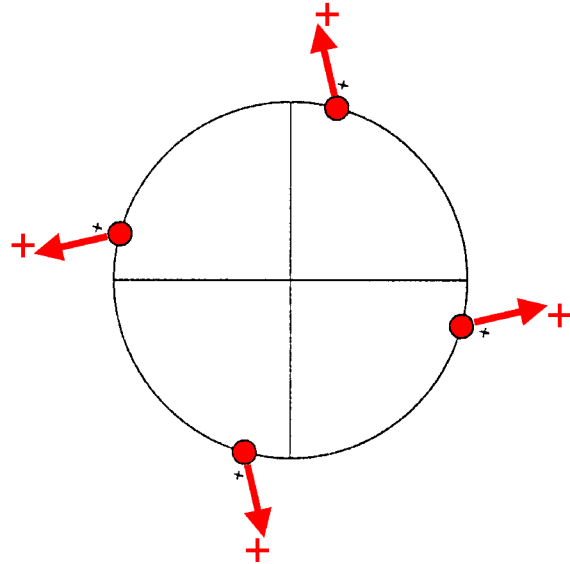
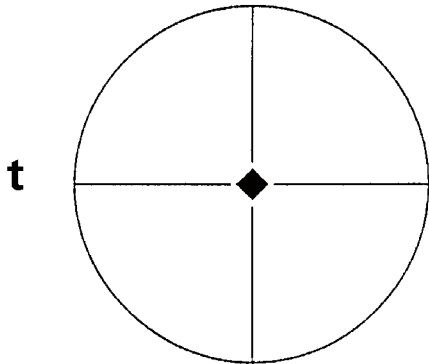

Origin on 4

Asymmetric unit $0 \leq x$; $0 \leq y$; $0 \leq z \leq 1$

Symmetry operations

(1) 1
(1|0,0,0)

(2) 2 $0,0,z$
(2_z |0,0,0)

(3) 4^+ $0,0,z$
(4_z |0,0,0)

(4) 4^- $0,0,z$
(4_z^{-1} |0,0,0)

Generators selected (1); $t(0,0,1)$; (2); (3)

Positions

Multiplicity, Wyckoff letter, Site symmetry	Coordinates	
4 b 1	(1) $x,y,z [u,v,w]$	(2) $\bar{x},\bar{y},z [\bar{u},\bar{v},w]$
	(3) $\bar{y},x,z [\bar{v},u,w]$	(4) $y,\bar{x},z [v,\bar{u},w]$
	0,0,z [0,0,w]	
	1 a 4..	

Symmetry of special projections

Along [001] 4 Origin at 0,0,z	Along [100] $p11m'$ $a^* = c$ Origin at x,0,0	Along [110] $p11m'$ $a^* = c$ Origin at x,x,0
----------------------------------	---	---

$p41'$

No. 23.2.121

$41'$

$p41'$

Tetragonal

t

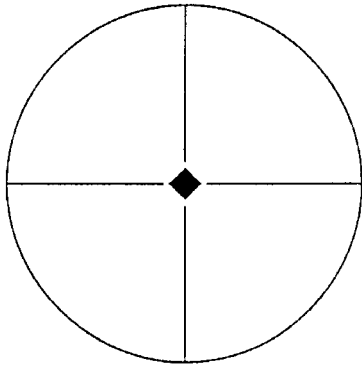

1'

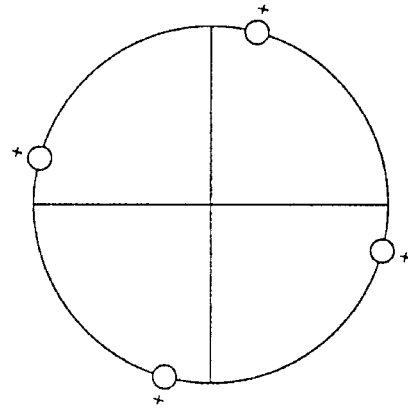

Origin on $41'$

Asymmetric unit $0 \leq x; 0 \leq y; 0 \leq z \leq 1$

Symmetry operations

For $1 +$ set

- | | | | |
|--------------------|----------------------------------|--------------------------------------|---|
| (1) 1
(1 0,0,0) | (2) 2 $0,0,z$
(2_z 0,0,0) | (3) 4^+ $0,0,z$
(4_z 0,0,0) | (4) 4^- $0,0,z$
(4_z^{-1} 0,0,0) |
|--------------------|----------------------------------|--------------------------------------|---|

For $1' +$ set

- | | | | |
|------------------------|--------------------------------------|--|---|
| (1) $1'$
(1 0,0,0)' | (2) $2'$ $0,0,z$
(2_z 0,0,0)' | (3) $4^{+'}$ $0,0,z$
(4_z 0,0,0)' | (4) $4^{-'}$ $0,0,z$
(4_z^{-1} 0,0,0)' |
|------------------------|--------------------------------------|--|---|

Generators selected (1); $t(0,0,1)$; (2); (3); $1'$

Positions

Multiplicity, Wyckoff letter, Site symmetry	Coordinates	
	$1+$	$1'+$
4 b $11'$	(1) $x,y,z [0,0,0]$	(2) $\bar{x},\bar{y},z [0,0,0]$
	(3) $\bar{y},x,z [0,0,0]$	(4) $y,\bar{x},z [0,0,0]$
1 a $4..1'$	$0,0,z [0,0,0]$	

Symmetry of special projections

Along $[001] 41'$	Along $[100] p11m1'$	Along $[110] p11m1'$
Origin at $0,0,z$	$a^* = c$ Origin at $x,0,0$	$a^* = c$ Origin at $x,x,0$

$p4'$

No. 23.3.122

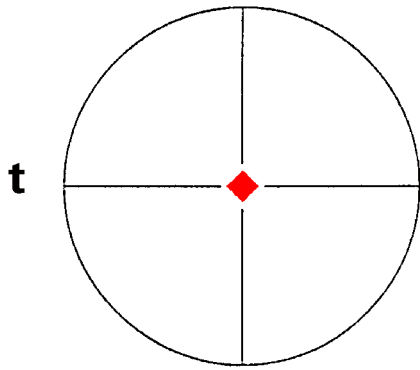

$4'$

$p4'$

Tetragonal

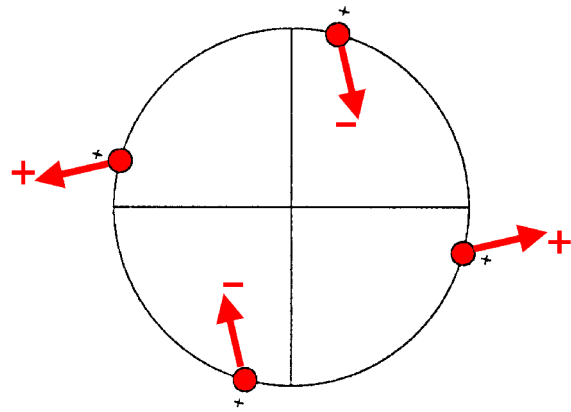

Origin on $4'$

Asymmetric unit $0 \leq x; 0 \leq y; 0 \leq z \leq 1$

Symmetry operations

(1) 1
(1|0,0,0)

(2) $2_{0,0,z}$
(2_z |0,0,0)

(3) $4^{+'}_{0,0,z}$
(4_z^{+} |0,0,0)'

(4) $4^{-'}_{0,0,z}$
(4_z^{-} |0,0,0)'

Generators selected (1); $t(0,0,1)$; (2); (3)

Positions

Multiplicity, Wyckoff letter, Site symmetry	Coordinates	
		(1) x,y,z [u,v,w]
	(3) \bar{y},x,z [v,\bar{u},\bar{w}]	(4) y,\bar{x},z [\bar{v},u,\bar{w}]
4 b 1		
1 a 4'..	0,0,z [0,0,0]	

Symmetry of special projections

Along [001] 4'	Along [100] $\rho 11m'$ $a^* = c$	Along [110] $\rho 11m'$ $a^* = c$
Origin at 0,0,z	Origin at x,0,0	Origin at x,x,0

$p_{2c}4'$

$41'$

Tetragonal

No. 23.4.123

$p_{2c}4'$

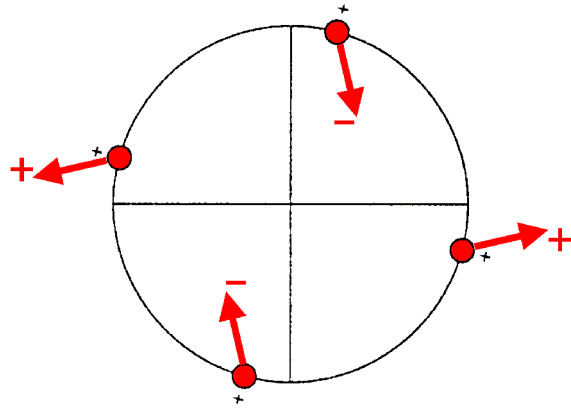
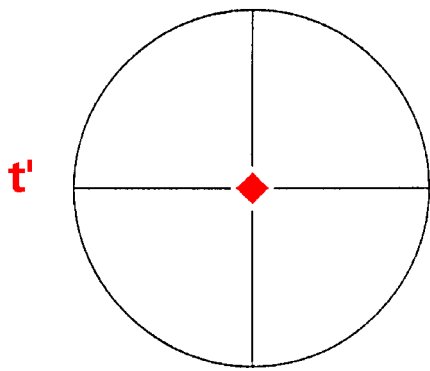

Origin on $4'$

Asymmetric unit $0 \leq x; 0 \leq y; 0 \leq z \leq 1$

Symmetry operations

For $(0,0,0)$ + set

(1) 1

$(1|0,0,0)$

(2) 2 $0,0,z$

$(2_z|0,0,0)$

(3) 4^{+} $0,0,z$

$(4_z|0,0,0)'$

(4) 4^{-} $0,0,z$

$(4_z^{-1}|0,0,0)'$

For $(0,0,1)'$ + set

(1) t' $(0,0,1)$

$(1|0,0,1)'$

(2) $2'$ $(0,0,1)$ $0,0,z$

$(2_z|0,0,1)'$

(3) 4^{+} $(0,0,1)$ $0,0,z$

$(4_z|0,0,1)$

(4) 4^{-} $(0,0,1)$ $0,0,z$

$(4_z^{-1}|0,0,1)$

Generators selected (1); $t(0,0,1)'$; (2); (3)

Positions

Multiplicity, Wyckoff letter, Site symmetry	Coordinates	
	(0,0,0)+	(0,0,1)' +
4 b 1	(1) x,y,z [u,v,w] (3) \bar{y},x,z [v,\bar{u},\bar{w}]	(2) \bar{x},\bar{y},z [\bar{u},\bar{v},w] (4) y,\bar{x},z [\bar{v},u,\bar{w}]
1 a 4'..	0,0,z [0,0,0]	

Symmetry of special projections

Along [001] 41'	Along [100] $\rho_{2a^*} 11m'$ $a^* = c$	Along [110] $\rho_{2a^*} 11m'$ $a^* = c$
Origin at 0,0,z	Origin at x,0,0	Origin at x,x,0

$p_{2c}4$

No. 23.5.124

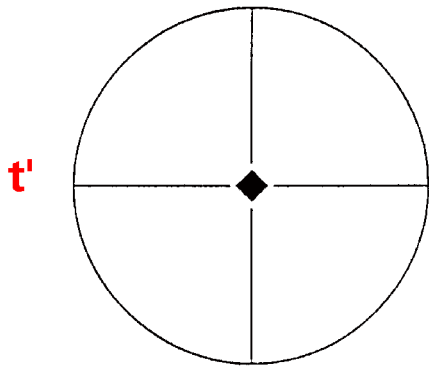

$41'$

$p_{2c}4$

Tetragonal

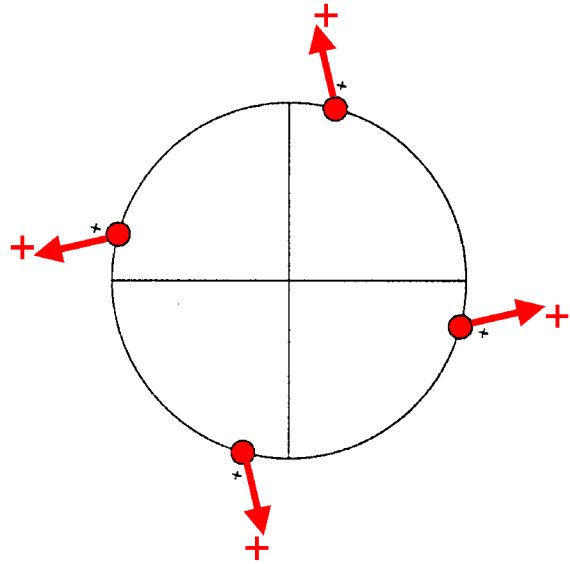

Origin on 4

Asymmetric unit $0 \leq x; 0 \leq y; 0 \leq z \leq 1$

Symmetry operations

For $(0,0,0) +$ set

- | | | | |
|---------------|---------------------|-----------------------|--------------------------|
| (1) 1 | (2) $2 \quad 0,0,z$ | (3) $4^+ \quad 0,0,z$ | (4) $4^- \quad 0,0,z$ |
| (1 $0,0,0$) | (2_z $0,0,0$) | (4_z $0,0,0$) | (4_z^{-1} $0,0,0$) |

For $(0,0,1)'$ + set

- | | | | |
|------------------------|------------------------------------|--|--|
| (1) $t' \quad (0,0,1)$ | (2) $2' \quad (0,0,1) \quad 0,0,z$ | (3) $4^{+'} \quad (0,0,1) \quad 0,0,z$ | (4) $4^{-'} \quad (0,0,1) \quad 0,0,z$ |
| (1 $0,0,1$)' | (2_z $0,0,1$)' | (4_z $0,0,1$)' | (4_z^{-1} $0,0,1$)' |

Generators selected (1); $t(0,0,1)'$; (2); (3)

Positions

Multiplicity, Wyckoff letter, Site symmetry	Coordinates	
	(0,0,0)+	(0,0,1)' +
4 b 1	(1) $x,y,z [u,v,w]$	(2) $\bar{x},\bar{y},z [\bar{u},\bar{v},w]$
	(3) $\bar{y},x,z [\bar{v},u,w]$	(4) $y,\bar{x},z [v,\bar{u},w]$
1 a 4..	0,0,z [0,0,w]	

Symmetry of special projections

Along [001] 41'	Along [100] $p_{2a^*}11m'$ $a^* = c$	Along [110] $p_{2a^*}11m'$ $a^* = c$
Origin at 0,0,z	Origin at x,0,0	Origin at x,x,0

$p4_1$

4

Tetragonal

No. 24.1.125

$p4_1$

t

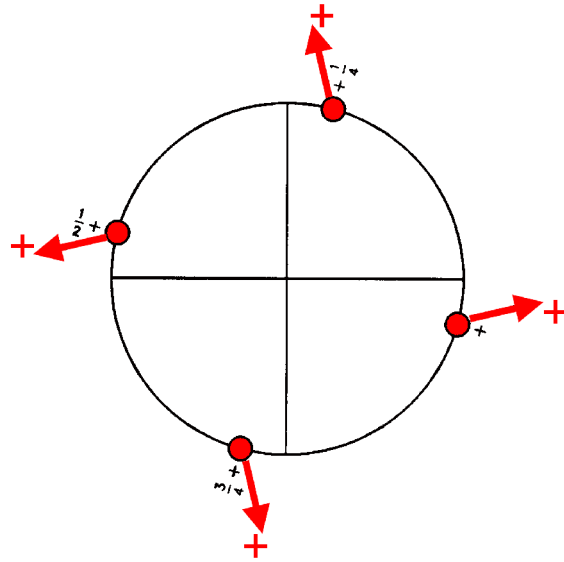
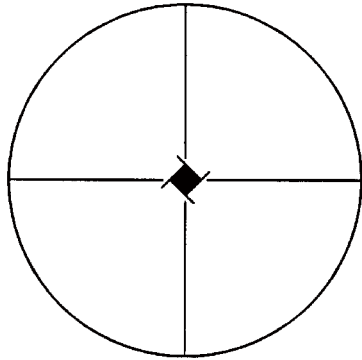

Origin on 4_1

Asymmetric unit $0 \leq x; 0 \leq y; 0 \leq z \leq 1$

Symmetry operations

- | | | | |
|--------------------|--|--|--|
| (1) 1
(1 0,0,0) | (2) 2 (0,0,1/2) 0,0,z
(2 _z 0,0,1/2) | (3) 4 ⁺ (0,0,1/4) 0,0,z
(4 _z ⁺ 0,0,1/4) | (4) 4 ⁻ (0,0,3/4) 0,0,z
(4 _z ⁻ 0,0,3/4) |
|--------------------|--|--|--|

Generators selected (1); $t(0,0,1)$; (2); (3)

Positions

Multiplicity, Wyckoff letter, Site symmetry	Coordinates	
	4 a 1	(1) x,y,z [u,v,w]
	(3) $\bar{y},x,z+1/4$ [\bar{v},u,w]	(4) $y,\bar{x},z+3/4$ [v,\bar{u},w]

Symmetry of special projections

Along [001] 4	Along [100] $p11g'$ $a^* = c$	Along [110] $p11g'$ $a^* = c$
Origin at 0,0,z	Origin at x,0,0	Origin at x,x,0

$p4_11'$

No. 24.2.126

$41'$

$p4_11'$

Tetragonal

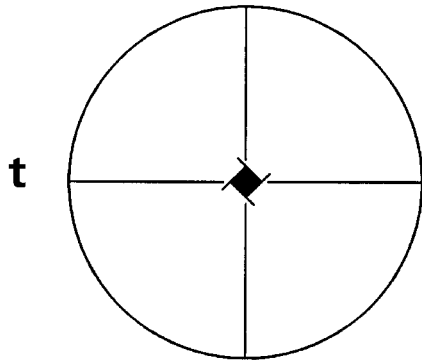

1'

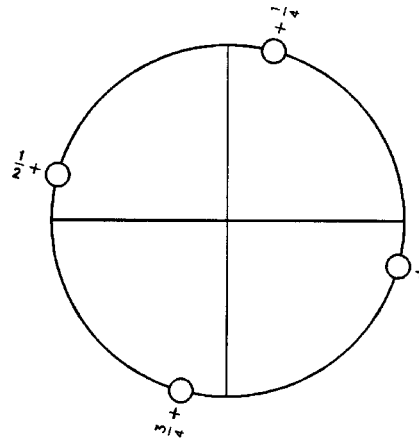

Origin on $4_11'$

Asymmetric unit $0 \leq x; 0 \leq y; 0 \leq z \leq 1$

Symmetry operations

- For $1 +$ set
- | | | | |
|--------------------|--|---|---|
| (1) 1
(1 0,0,0) | (2) 2 (0,0,1/2) 0,0,z
(2 _z 0,0,1/2) | (3) 4 ⁺ (0,0,1/4) 0,0,z
(4 _z 0,0,1/4) | (4) 4 ⁻ (0,0,3/4) 0,0,z
(4 _z ⁻¹ 0,0,3/4) |
|--------------------|--|---|---|
- For $1' +$ set
- | | | | |
|----------------------|--|--|--|
| (1) 1'
(1 0,0,0)' | (2) 2' (0,0,1/2) 0,0,z
(2 _z 0,0,1/2)' | (3) 4 ⁺ ' (0,0,1/4) 0,0,z
(4 _z 0,0,1/4)' | (4) 4 ⁻ ' (0,0,3/4) 0,0,z
(4 _z ⁻¹ 0,0,3/4)' |
|----------------------|--|--|--|

Continued

No. 24.2.126

$p4_11'$

Generators selected (1); $t(0,0,1)$; (2); (3); $1'$

Positions

Multiplicity, Wyckoff letter, Site symmetry	Coordinates	
	1+	$1' +$
4 a $11'$	(1) x,y,z [0,0,0]	(2) $\bar{x},\bar{y},z+1/2$ [0,0,0]
	(3) $\bar{y},x,z+1/4$ [0,0,0]	(4) $y,\bar{x},z+3/4$ [0,0,0]

Symmetry of special projections

Along [001] $41'$	Along [100] $p11g1'$	Along [110] $p11g1'$
Origin at 0,0,z	$a^* = c$ Origin at x,0,0	$a^* = c$ Origin at x,x,0

$p4_1'$

No. 24.3.127

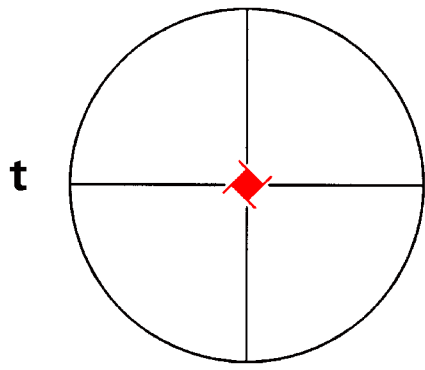

$4'$

$p4_1'$

Tetragonal

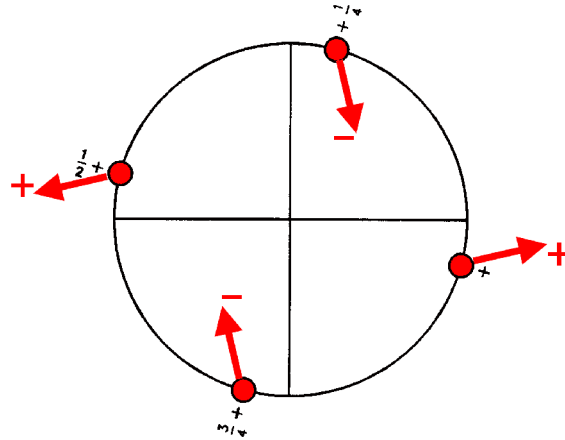

Origin on $4_1'$

Asymmetric unit $0 \leq x; 0 \leq y; 0 \leq z \leq 1$

Symmetry operations

- | | | | |
|--------------------|--|---|---|
| (1) 1
(1 0,0,0) | (2) 2 (0,0,1/2) 0,0,z
(2 _z 0,0,1/2) | (3) 4 ⁺ (0,0,1/4) 0,0,z
(4 _z ⁺ 0,0,1/4)' | (4) 4 ⁻ (0,0,3/4) 0,0,z
(4 _z ⁻ 0,0,3/4)' |
|--------------------|--|---|---|

Continued

No. 24.3.127

$p4_1'$

Generators selected (1); $t(0,0,1)$; (2); (3)

Positions

	Coordinates	
Multiplicity, Wyckoff letter, Site symmetry		
4 a 1	(1) x,y,z [u,v,w]	(2) $\bar{x},\bar{y},z+1/2$ [\bar{u},\bar{v},w]
	(3) $\bar{y},x,z+1/4$ [v,\bar{u},\bar{w}]	(4) $y,\bar{x},z+3/4$ [\bar{v},u,\bar{w}]

Symmetry of special projections

Along [001] $4'$	Along [100] $p11g'$	Along [110] $p11g'$
	$a^* = c$	$a^* = c$
Origin at $0,0,z$	Origin at $x,0,0$	Origin at $x,x,0$

$p4_2$

4

Tetragonal

No. 25.1.128

$p4_2$

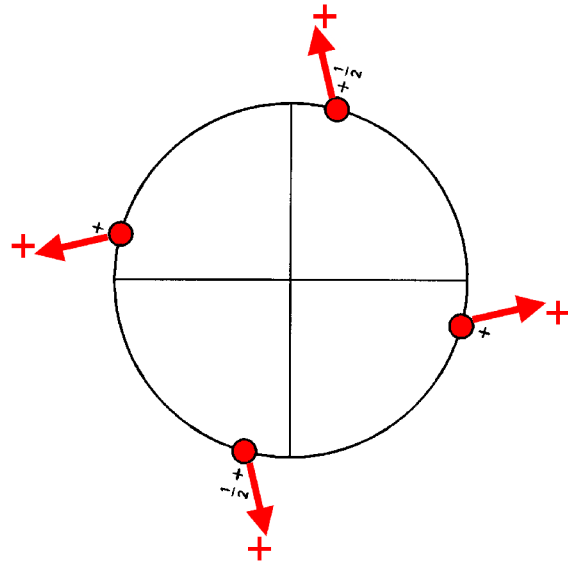
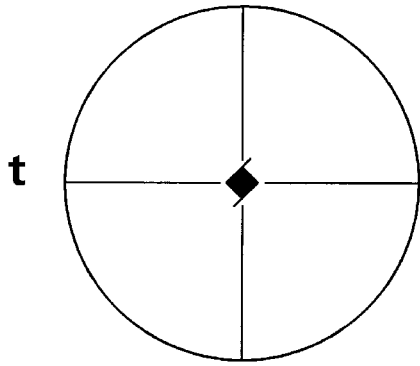

Origin on 2 on 4_2

Asymmetric unit $0 \leq x; 0 \leq y; 0 \leq z \leq 1$

Symmetry operations

(1) 1
(1|0,0,0)

(2) 2 $0,0,z$
(2_z |0,0,0)

(3) 4^+ (0,0,1/2) $0,0,z$
(4_z |0,0,1/2)

(4) 4^- (0,0,1/2) $0,0,z$
(4_z^{-1} |0,0,1/2)

Generators selected (1); $t(0,0,1)$; (2); (3)

Positions

Multiplicity, Wyckoff letter, Site symmetry	Coordinates	
	(1) x,y,z [u,v,w]	(2) \bar{x},\bar{y},z [\bar{u},\bar{v},w]
4 b 1	(3) $\bar{y},x,z+1/2$ [\bar{v},u,w]	(4) $y,\bar{x},z+1/2$ [v,\bar{u},w]
2 a 2..	$0,0,z$ [$0,0,w$]	$0,0,z+1/2$ [$0,0,w$]

Symmetry of special projections

Along [001] 4	Along [100] $p11m'$ $a^* = c$	Along [110] $p11m'$ $a^* = c$
Origin at $0,0,z$	Origin at $x,0,0$	Origin at $x,x,0$

$p4_21'$

No. 25.2.129

$41'$

$p4_21'$

Tetragonal

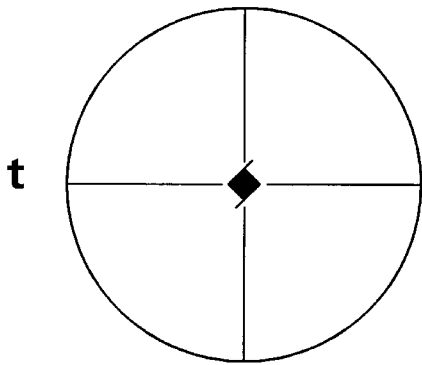

1'

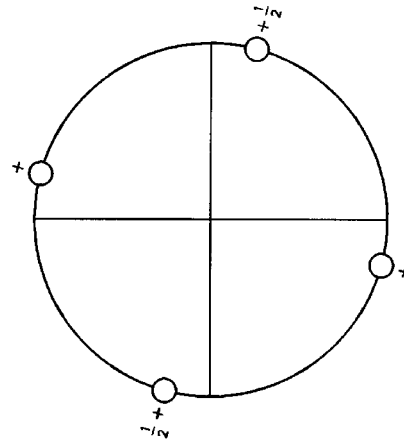

Origin on $21'$ on $4_21'$

Asymmetric unit $0 \leq x; 0 \leq y; 0 \leq z \leq 1$

Symmetry operations

- For $1 +$ set
- | | | | |
|--------------------|--|---|---|
| (1) 1
(1 0,0,0) | (2) 2 0,0,z
(2 _z 0,0,0) | (3) 4 ⁺ (0,0,1/2) 0,0,z
(4 _z 0,0,1/2) | (4) 4 ⁻ (0,0,1/2) 0,0,z
(4 _z ⁻¹ 0,0,1/2) |
|--------------------|--|---|---|
- For $1' +$ set
- | | | | |
|----------------------|--|---|---|
| (1) 1'
(1 0,0,0)' | (2) 2' 0,0,z
(2 _z 0,0,0)' | (3) 4 ^{+'} (0,0,1/2) 0,0,z
(4 _z 0,0,1/2)' | (4) 4 ^{-'} (0,0,1/2) 0,0,z
(4 _z ⁻¹ 0,0,1/2)' |
|----------------------|--|---|---|

Generators selected (1); $t(0,0,1)$; (2); (3); $1'$

Positions

Multiplicity, Wyckoff letter, Site symmetry	Coordinates	
	1+	1' +
4 b $11'$	(1) $x,y,z [0,0,0]$	(2) $\bar{x},\bar{y},z [0,0,0]$
	(3) $\bar{y},x,z+1/2 [0,0,0]$	(4) $y,\bar{x},z+1/2 [0,0,0]$
2 a $2..1'$	$0,0,z [0,0,0]$	$0,0,z+1/2 [0,0,0]$

Symmetry of special projections

Along $[001] 41'$	Along $[100] p11m1'$	Along $[110] p11m1'$
Origin at $0,0,z$	$a^* = c$ Origin at $x,0,0$	$a^* = c$ Origin at $x,x,0$

$p4_2'$

No. 25.3.130

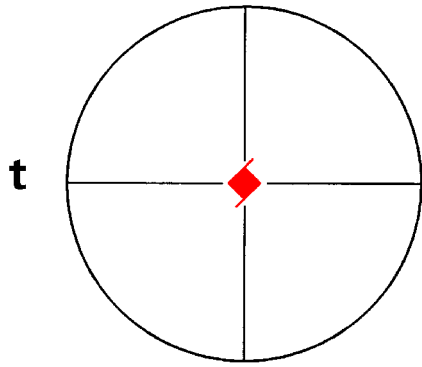

$4'$

$p4_2'$

Tetragonal

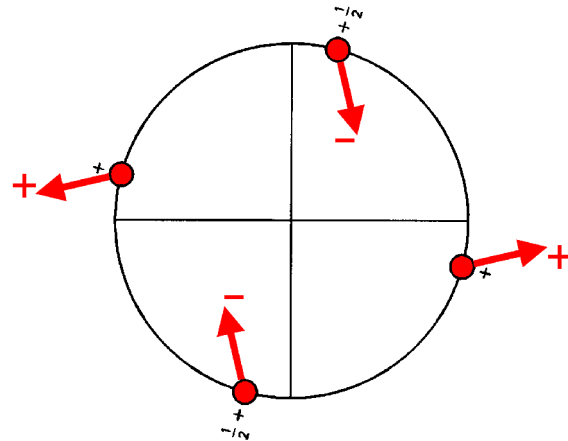

Origin on 2 on $4_2'$

Asymmetric unit $0 \leq x; 0 \leq y; 0 \leq z \leq 1$

Symmetry operations

(1) 1
(1|0,0,0)

(2) 2 $0,0,z$
(2_z |0,0,0)

(3) $4^{+1}(0,0,1/2) 0,0,z$
(4_z |0,0,1/2)'

(4) $4^{-1}(0,0,1/2) 0,0,z$
(4_z^{-1} |0,0,1/2)'

Generators selected (1); $t(0,0,1)$; (2); (3)

Positions

Multiplicity, Wyckoff letter, Site symmetry	Coordinates	
		(1) x,y,z [u,v,w]
	(3) $\bar{y},x,z+1/2$ [v,\bar{u},\bar{w}]	(4) $y,\bar{x},z+1/2$ [\bar{v},u,\bar{w}]
4 b 1		
2 a 2..	$0,0,z$ [$0,0,w$]	$0,0,z+1/2$ [$0,0,\bar{w}$]

Symmetry of special projections

Along [001] $4'$	Along [100] $p11m'$	Along [110] $p11m'$
Origin at $0,0,z$	$a^* = c$ Origin at $x,0,0$	$a^* = c$ Origin at $x,x,0$

$p_{2c}4_2$

$41'$

Tetragonal

No. 25.4.131

$p_{2c}4_2$

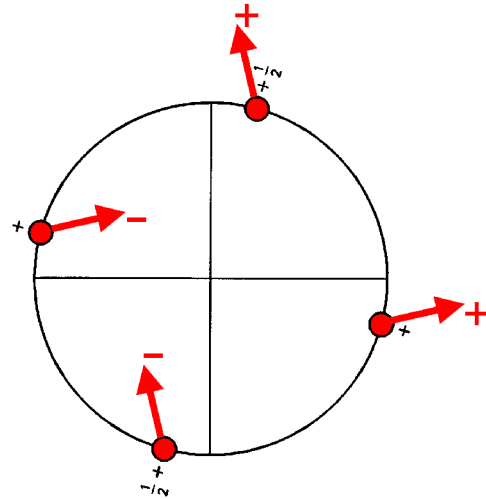
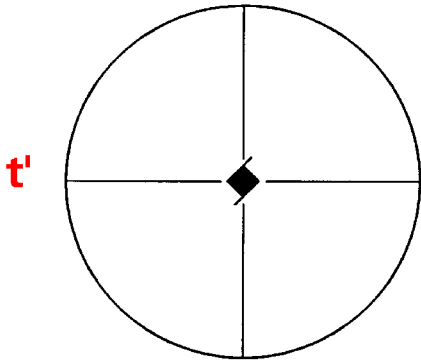

Origin on $2'$ on 4_2

Asymmetric unit $0 \leq x; 0 \leq y; 0 \leq z \leq 1$

Symmetry operations

For $(0,0,0)$ + set

- | | | | |
|---------------|----------------------|-------------------------------|-------------------------------|
| (1) 1 | (2) $2'$ $0,0,z$ | (3) 4^+ $(0,0,1/2)$ $0,0,z$ | (4) 4^- $(0,0,1/2)$ $0,0,z$ |
| (1 $0,0,0$) | (2_z $0,0,0$)' | (4_z $0,0,1/2$) | (4_z^{-1} $0,0,1/2$)' |

For $(0,0,1)$ + set

- | | | | |
|--------------------|---------------------------|---------------------------------|---------------------------------|
| (1) t' $(0,0,1)$ | (2) 2 $(0,0,1)$ $0,0,z$ | (3) 4^{+} $(0,0,3/2)$ $0,0,z$ | (4) 4^{-} $(0,0,3/2)$ $0,0,z$ |
| (1 $0,0,1$)' | (2_z $0,0,1$) | (4_z $0,0,3/2$)' | (4_z^{-1} $0,0,3/2$) |

Generators selected (1); $t(0,0,1)'$; (2); (3)

Positions

Multiplicity, Wyckoff letter, Site symmetry	Coordinates	
	(0,0,0)+	(0,0,1)' +
4 b 1	(1) $x,y,z [u,v,w]$	(2) $\bar{x},\bar{y},z [u,v,\bar{w}]$
	(3) $\bar{y},x,z+1/2 [\bar{v},u,w]$	(4) $y,\bar{x},z+1/2 [v,u,\bar{w}]$
2 a 2'..	$0,0,z [u,v,0]$	$0,0,z+1/2 [\bar{v},u,0]$

Symmetry of special projections

Along [001] $41'$	Along [100] $\rho_{2a^*} 11m$ $a^* = c$	Along [110] $\rho_{2a^*} 11m$ $a^* = c$
Origin at 0,0,z	Origin at x,0,0	Origin at x,x,0

$p_{2c}4_2'$

$41'$

Tetragonal

No. 25.5.132

$p_{2c}4_2'$

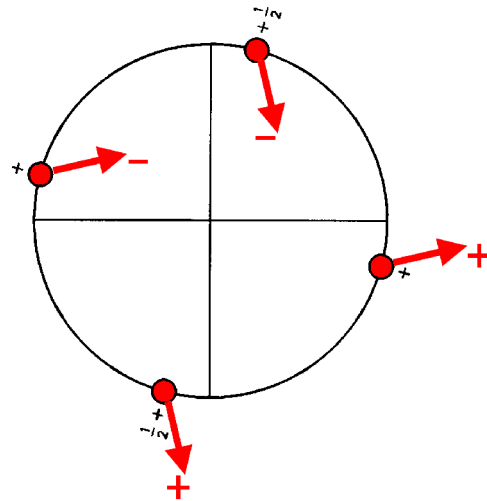
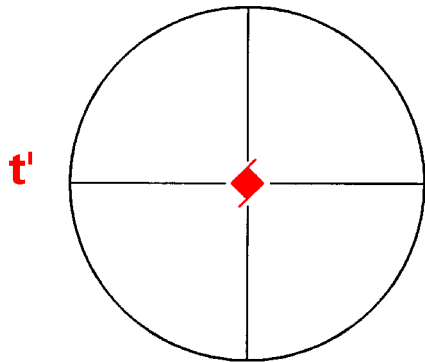

Origin on $2'$ on $4_2'$

Asymmetric unit $0 \leq x$; $0 \leq y$; $0 \leq z \leq 1$

Symmetry operations

For $(0,0,0)$ + set

- | | | | |
|-------------|------------------|---------------------------------|---------------------------------|
| (1) 1 | (2) $2'$ $0,0,z$ | (3) 4^{+} $(0,0,1/2)$ $0,0,z$ | (4) 4^{-} $(0,0,1/2)$ $0,0,z$ |
| $(1 0,0,0)$ | $(2_z 0,0,0)'$ | $(4_z 0,0,1/2)'$ | $(4_z^{-1} 0,0,1/2)$ |

For $(0,0,1)'$ + set

- | | | | |
|--------------------|---------------------------|---------------------------------|---------------------------------|
| (1) t' $(0,0,1)$ | (2) 2 $(0,0,1)$ $0,0,z$ | (3) 4^{+} $(0,0,3/2)$ $0,0,z$ | (4) 4^{-} $(0,0,3/2)$ $0,0,z$ |
| $(1 0,0,1)'$ | $(2_z 0,0,1)$ | $(4_z 0,0,3/2)$ | $(4_z^{-1} 0,0,3/2)'$ |

Generators selected (1); $t(0,0,1)'$; (2); (3)

Positions

Multiplicity, Wyckoff letter, Site symmetry	Coordinates	
	(0,0,0)+	(0,0,1)' +
4 b 1	(1) x,y,z [u,v,w]	(2) \bar{x},\bar{y},z [u,v, \bar{w}]
	(3) $\bar{y},x,z+1/2$ [v, \bar{u},\bar{w}]	(4) $y,\bar{x},z+1/2$ [v, \bar{u},w]
2 a 2'..	0,0,z [u,v,0]	0,0,z+1/2 [v, $\bar{u},0$]

Symmetry of special projections

Along [001] $41'$	Along [100] $P_{2a^*} 11m$ $a^* = c$	Along [110] $P_{2a^*} 11m$ $a^* = c$
Origin at 0,0,z	Origin at x,0,0	Origin at x,x,0

$p4_3$

4

Tetragonal

No. 26.1.133

$p4_3$

t

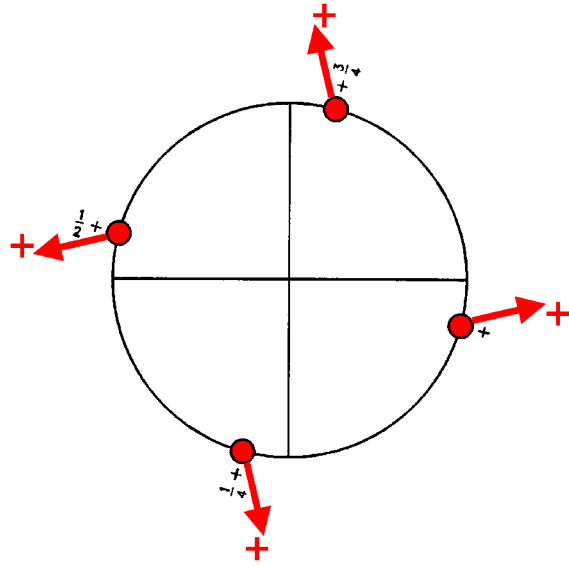
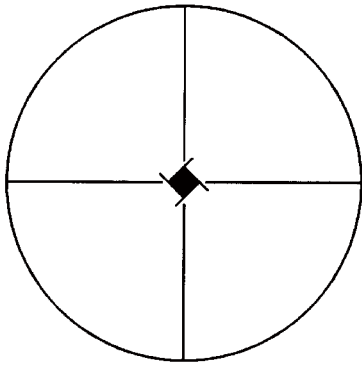

Origin on 4_3

Asymmetric unit $0 \leq x; 0 \leq y; 0 \leq z \leq 1$

Symmetry operations

- | | | | |
|--------------------|--|--|--|
| (1) 1
(1 0,0,0) | (2) 2 (0,0,1/2) 0,0,z
(2 _z 0,0,1/2) | (3) 4 ⁺ (0,0,3/4) 0,0,z
(4 _z ⁺ 0,0,3/4) | (4) 4 ⁻ (0,0,1/4) 0,0,z
(4 _z ⁻ 0,0,1/4) |
|--------------------|--|--|--|

Generators selected (1); $t(0,0,1)$; (2); (3)

Positions

Multiplicity, Wyckoff letter, Site symmetry	Coordinates	
	4 a 1	(1) x,y,z [u,v,\bar{w}]
	(3) $\bar{y},x,z+3/4$ [\bar{v},u,w]	(4) $y,\bar{x},z+1/4$ [v,\bar{u},w]

Symmetry of special projections

Along [001] 4	Along [100] $p11g'$ $a^* = c$	Along [110] $p11g'$ $a^* = c$
Origin at 0,0,z	Origin at x,0,0	Origin at x,x,0

$p4_31'$

No. 26.2.134

$41'$

$p4_31'$

Tetragonal

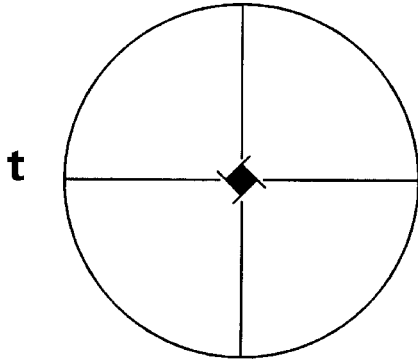

1'

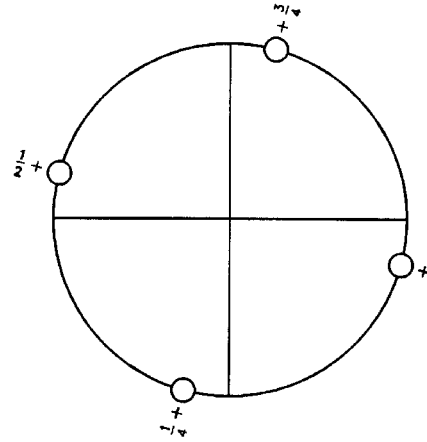

Origin on $4_31'$

Asymmetric unit $0 \leq x; 0 \leq y; 0 \leq z \leq 1$

Symmetry operations

For $1 +$ set

- | | | | |
|--------------------|--|---|---|
| (1) 1
(1 0,0,0) | (2) 2 (0,0,1/2) 0,0,z
(2 _z 0,0,1/2) | (3) 4 ⁺ (0,0,3/4) 0,0,z
(4 _z 0,0,3/4) | (4) 4 ⁻ (0,0,1/4) 0,0,z
(4 _z ⁻¹ 0,0,1/4) |
|--------------------|--|---|---|

For $1' +$ set

- | | | | |
|----------------------|--|---|---|
| (1) 1'
(1 0,0,0)' | (2) 2' (0,0,1/2) 0,0,z
(2 _z 0,0,1/2)' | (3) 4 ^{+'} (0,0,3/4) 0,0,z
(4 _z 0,0,3/4)' | (4) 4 ^{'-} (0,0,1/4) 0,0,z
(4 _z ⁻¹ 0,0,1/4)' |
|----------------------|--|---|---|

Continued

No. 26.2.134

$p4_31'$

Generators selected (1); $t(0,0,1)$; (2); (3); $1'$

Positions

Multiplicity, Wyckoff letter, Site symmetry	Coordinates	
	1+	$1' +$
4 a $11'$	(1) x,y,z [0,0,0]	(2) $\bar{x},\bar{y},z+1/2$ [0,0,0]
	(3) $\bar{y},x,z+3/4$ [0,0,0]	(4) $y,\bar{x},z+1/4$ [0,0,0]

Symmetry of special projections

Along [001] $41'$	Along [100] $p11g1'$	Along [110] $p11g1'$
Origin at 0,0,z	$a^* = c$ Origin at x,0,0	$a^* = c$ Origin at x,x,0

$p4_3'$

No. 26.3.135

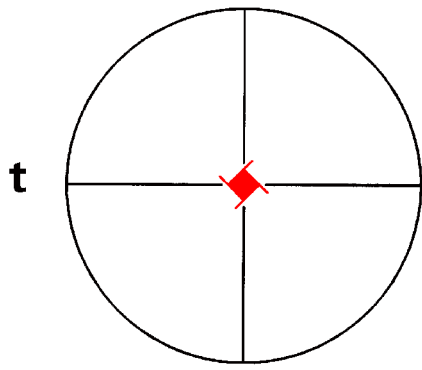

$4'$

$p4_3'$

Tetragonal

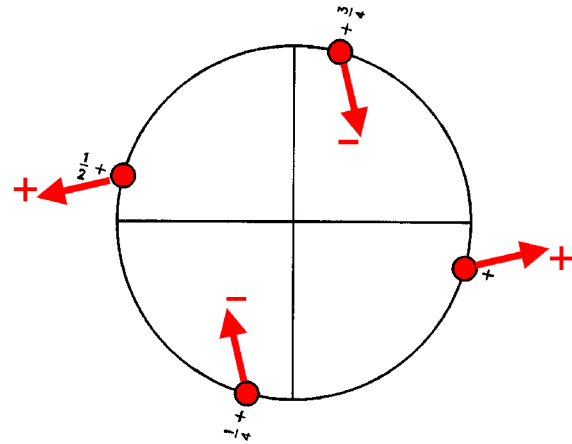

Origin on $4_3'$

Asymmetric unit $0 \leq x$; $0 \leq y$; $0 \leq z \leq 1$

Symmetry operations

- (1) 1
(1|0,0,0)
- (2) 2 (0,0,1/2) 0,0,z
(2_z|0,0,1/2)
- (3) 4⁺ (0,0,3/4) 0,0,z
(4_z|0,0,3/4)'
- (4) 4⁻ (0,0,1/4) 0,0,z
(4_z⁻¹|0,0,1/4)'

Generators selected (1); $t(0,0,1)$; (2); (3)

Positions

Multiplicity, Wyckoff letter, Site symmetry	Coordinates	
	4 a 1	(1) x,y,z [u,v,w]
	(3) $\bar{y},x,z+3/4$ [v,\bar{u},\bar{w}]	(4) $y,\bar{x},z+1/4$ [\bar{v},u,\bar{w}]

Symmetry of special projections

Along [001] $4'$	Along [100] $p11g'$	Along [110] $p11g'$
Origin at 0,0,z	$a^* = c$ Origin at $x,0,0$	$a^* = c$ Origin at $x,x,0$

$p\bar{4}$

No. 27.1.136

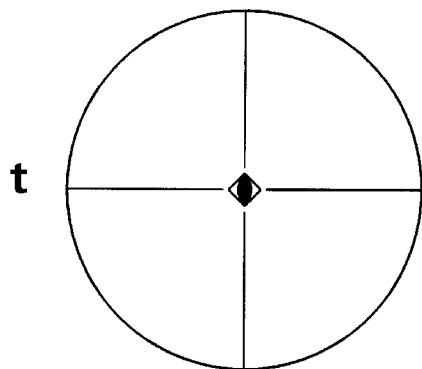

$\bar{4}$

$p\bar{4}$

Tetragonal

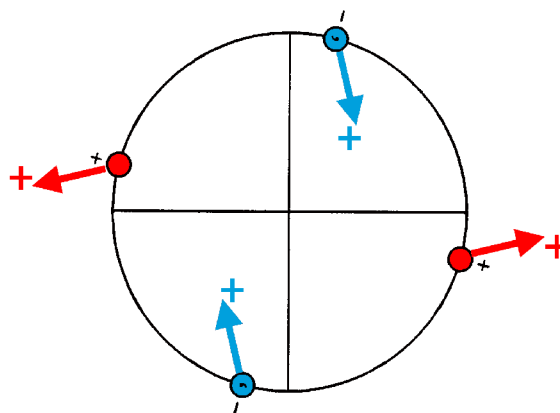

Origin at $\bar{4}$

Asymmetric unit $0 \leq x; 0 \leq y; 0 \leq z \leq 1$

Symmetry operations

(1) 1
(1|0,0,0)

(2) 2 $0,0,z$
(2_z |0,0,0)

(3) $\bar{4}^+$ $0,0,z; 0,0,0$
($\bar{4}_z$ |0,0,0)

(4) $\bar{4}^-$ $0,0,z; 0,0,0$
($\bar{4}_z^{-1}$ |0,0,0)

Generators selected (1); $t(0,0,1)$; (2); (3)

Positions

Multiplicity, Wyckoff letter, Site symmetry	Coordinates	
	(1) x,y,z [u,v,w]	(2) \bar{x},\bar{y},z [\bar{u},\bar{v},w]
4 d 1	(3) y,\bar{x},\bar{z} [\bar{v},u,w]	(4) \bar{y},x,\bar{z} [v,\bar{u},w]
2 c 2..	$0,0,z$ [$0,0,w$]	$0,0,\bar{z}$ [$0,0,w$]
1 b $\bar{4}$..	$0,0,1/2$ [$0,0,w$]	
1 a $\bar{4}$..	$0,0,0$ [$0,0,w$]	

Symmetry of special projections

Along [001] 4'	Along [100] $p11m'$ $a^* = c$	Along [110] $p11m'$ $a^* = c$
Origin at $0,0,z$	Origin at $x,0,0$	Origin at $x,x,0$

$p\bar{4}1'$

No. 27.2.137

$\bar{4}1'$

$p\bar{4}1'$

Tetragonal

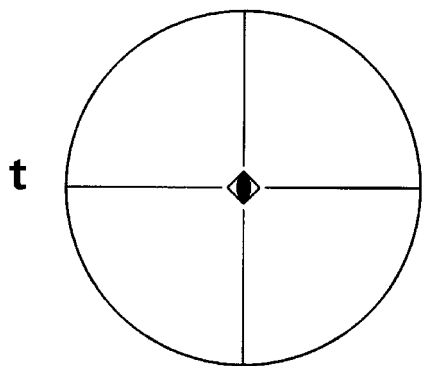

1'

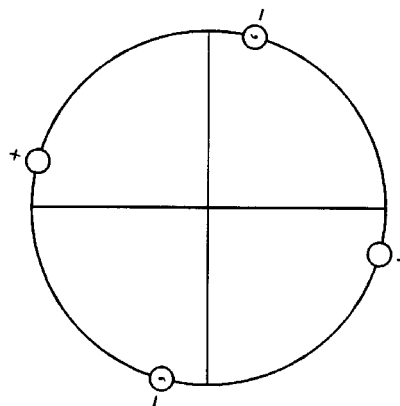

Origin at $\bar{4}1'$

Asymmetric unit $0 \leq x; 0 \leq y; 0 \leq z \leq 1$

Symmetry operations

For 1 + set

- | | | | |
|--------------------|--|---|--|
| (1) 1
(1 0,0,0) | (2) 2 0,0,z
(2 _z 0,0,0) | (3) $\bar{4}^+$ 0,0,z; 0,0,0
($\bar{4}_z$ 0,0,0) | (4) $\bar{4}^-$ 0,0,z; 0,0,0
($\bar{4}_z^{-1}$ 0,0,0) |
|--------------------|--|---|--|

For 1' + set

- | | | | |
|----------------------|--|---|--|
| (1) 1'
(1 0,0,0)' | (2) 2' 0,0,z
(2 _z 0,0,0)' | (3) $\bar{4}^{+'}$ 0,0,z; 0,0,0
($\bar{4}_z$ 0,0,0)' | (4) $\bar{4}^{-'}$ 0,0,z; 0,0,0
($\bar{4}_z^{-1}$ 0,0,0)' |
|----------------------|--|---|--|

Continued

No. 27.2.137

 $p\bar{4}1'$ Generators selected (1); $t(0,0,1)$; (2); (3); $1'$

Positions

Multiplicity, Wyckoff letter, Site symmetry	Coordinates	
	1+	1' +
4 d $11'$	(1) $x,y,z [0,0,0]$	(2) $\bar{x},\bar{y},z [0,0,0]$
	(3) $y,\bar{x},\bar{z} [0,0,0]$	(4) $\bar{y},x,\bar{z} [0,0,0]$
2 c $2..1'$	$0,0,z [0,0,0]$	$0,0,\bar{z} [0,0,0]$
1 b $\bar{4}..1'$	$0,0,1/2 [0,0,0]$	
1 a $\bar{4}..1'$	$0,0,0 [0,0,0]$	

Symmetry of special projections

Along $[001] 41'$	Along $[100] p11m1'$	Along $[110] p11m1'$
Origin at $0,0,z$	$a^* = c$ Origin at $x,0,0$	$a^* = c$ Origin at $x,x,0$

$\overline{p4}$

No. 27.3.138

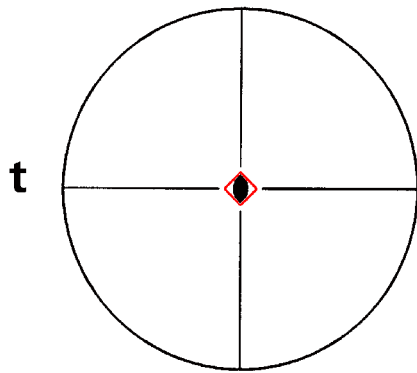

$\overline{4}$

Tetragonal

$\overline{p4}$

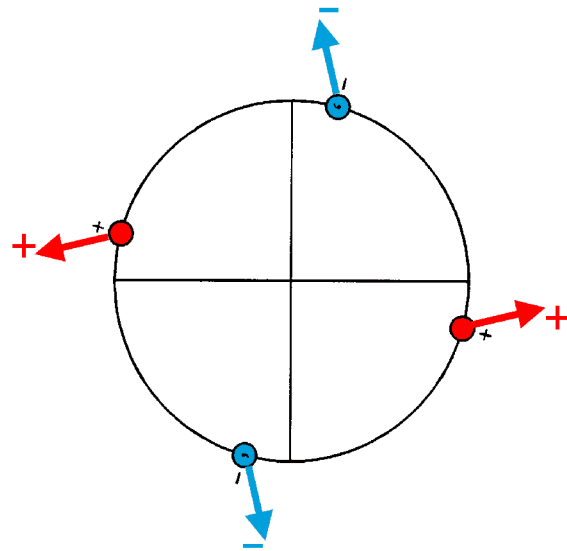

Origin at $\overline{4}$

Asymmetric unit $0 \leq x; 0 \leq y; 0 \leq z \leq 1$

Symmetry operations

(1) 1
(1|0,0,0)

(2) 2 $0,0,z$
(2_z |0,0,0)

(3) $\overline{4}^{+}$ $0,0,z; 0,0,0$
($\overline{4}_z$ |0,0,0)'

(4) $\overline{4}^{-}$ $0,0,z; 0,0,0$
($\overline{4}_z^{-1}$ |0,0,0)'

Continued

No. 27.3.138

 $p\bar{4}'$ Generators selected (1); $t(0,0,1)$; (2); (3)

Positions

Multiplicity, Wyckoff letter, Site symmetry	Coordinates	
		(1) x,y,z [u,v,w]
	(3) y,\bar{x},\bar{z} [v,\bar{u},\bar{w}]	(4) \bar{y},x,\bar{z} [\bar{v},u,\bar{w}]
4 d 1	$0,0,z$ [$0,0,w$]	$0,0,\bar{z}$ [$0,0,\bar{w}$]
2 c 2..	$0,0,1/2$ [$0,0,0$]	
1 b $\bar{4}'..$	$0,0,0$ [$0,0,0$]	
1 a $\bar{4}'..$	$0,0,0$ [$0,0,0$]	

Symmetry of special projections

Along [001] 4	Along [100] $p11m'$ $a^* = c$	Along [110] $p11m'$ $a^* = c$
Origin at $0,0,z$	Origin at $x,0,0$	Origin at $x,x,0$

$\rho_{2c}\bar{4}$

No. 27.4.139

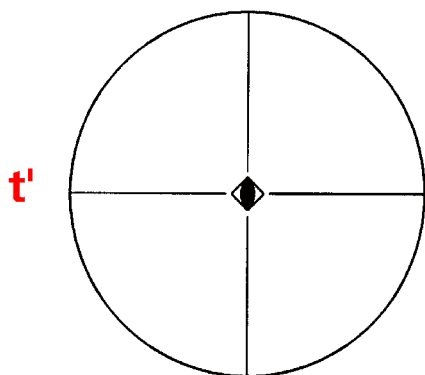

$\bar{4}1'$

$\rho_{2c}\bar{4}$

Tetragonal

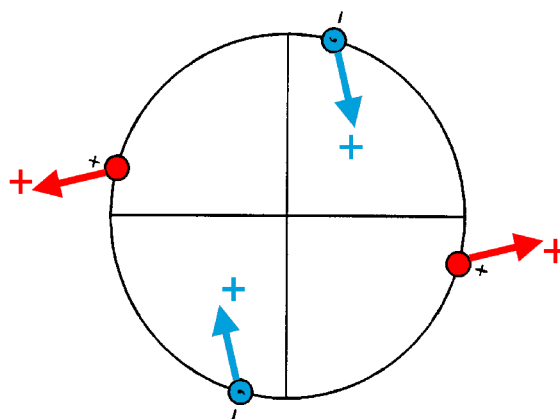

Origin at $\bar{4}$

Asymmetric unit $0 \leq x; 0 \leq y; 0 \leq z \leq 1$

Symmetry operations

For $(0,0,0)$ + set

- | | | | |
|---------------|---------------------|------------------------------------|------------------------------------|
| (1) 1 | (2) $2 \quad 0,0,z$ | (3) $\bar{4}^+ \quad 0,0,z; 0,0,0$ | (4) $\bar{4}^- \quad 0,0,z; 0,0,0$ |
| (1 $0,0,0$) | (2_z $0,0,0$) | ($\bar{4}_z$ $0,0,0$) | ($\bar{4}_z^{-1}$ $0,0,0$) |

For $(0,0,1)'$ + set

- | | | | |
|------------------------|------------------------------------|---|---|
| (1) $t' \quad (0,0,1)$ | (2) $2' \quad (0,0,1) \quad 0,0,z$ | (3) $\bar{4}^{+'} \quad 0,0,z; 0,0,1/2$ | (4) $\bar{4}^{-'} \quad 0,0,z; 0,0,1/2$ |
| (1 $0,0,1$)' | (2_z $0,0,1$)' | ($\bar{4}_z$ $0,0,1$)' | ($\bar{4}_z^{-1}$ $0,0,1$)' |

Generators selected (1); $t(0,0,1)'$; (2); (3)

Positions

Multiplicity, Wyckoff letter, Site symmetry	Coordinates	
	(0,0,0)+	(0,0,1)' +
4 d 1	(1) x,y,z [u,v,w] (3) y,\bar{x},\bar{z} [\bar{v},u,w]	(2) \bar{x},\bar{y},z [\bar{u},\bar{v},w] (4) \bar{y},x,\bar{z} [v, \bar{u},w]
2 c 2..	0,0,z [0,0,w]	0,0, \bar{z} [0,0,w]
1 b $\bar{4}$..	0,0,1/2 [0,0,0]	
1 a $\bar{4}$..	0,0,0 [0,0,0]	

Symmetry of special projections

Along [001] 41'	Along [100] $p11m'$ $a^* = c$	Along [110] $p11m'$ $a^* = c$
Origin at 0,0,z	Origin at x,0,0	Origin at x,x,0

$p4/m$

No. 28.1.140

$4/m$

$p4/m$

Tetragonal

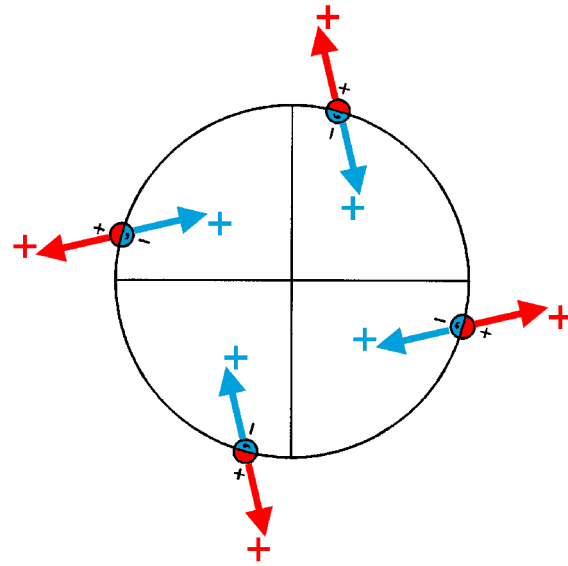
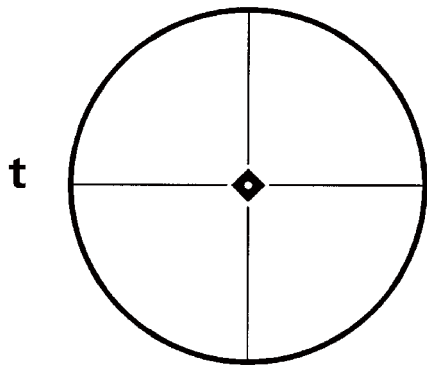

Origin at center ($4/m$)

Asymmetric unit $0 \leq x$; $0 \leq y$; $0 \leq z \leq 1/2$

Symmetry operations

- | | | | |
|--|--------------------------------------|---|---|
| (1) 1
(1 0,0,0) | (2) 2_{z} 0,0,z
(2_z 0,0,0) | (3) 4^+ 0,0,z
(4_z^+ 0,0,0) | (4) 4^- 0,0,z
(4_z^- 0,0,0) |
| (5) $\bar{1}$ 0,0,0
($\bar{1}$ 0,0,0) | (6) m_z x,y,0
(m_z 0,0,0) | (7) $\bar{4}^+$ 0,0,z; 0,0,0
($\bar{4}_z^+$ 0,0,0) | (8) $\bar{4}^-$ 0,0,z; 0,0,0
($\bar{4}_z^-$ 0,0,0) |

Generators selected (1); t(0,0,1); (2); (3); (5)

Positions

Multiplicity, Wyckoff letter, Site symmetry	Coordinates		
8 f 1	(1) x,y,z [u,v,w]	(2) \bar{x},\bar{y},z [\bar{u},\bar{v},w]	
	(3) \bar{y},x,z [\bar{v},u,w]	(4) y, \bar{x},z [v, \bar{u},w]	
	(5) \bar{x},\bar{y},\bar{z} [\bar{u},\bar{v},\bar{w}]	(6) x,y, \bar{z} [\bar{u},\bar{v},\bar{w}]	
	(7) y, \bar{x},\bar{z} [\bar{v},\bar{u},\bar{w}]	(8) \bar{y},x,\bar{z} [v, \bar{u},\bar{w}]	
	4 e m..	x,y,1/2 [0,0,w]	$\bar{x},\bar{y},1/2$ [0,0,w]
		$\bar{y},x,1/2$ [0,0,w]	y, $\bar{x},1/2$ [0,0,w]
	4 d m..	x,y,0 [0,0,w]	$\bar{x},\bar{y},0$ [0,0,w]
		$\bar{y},x,0$ [0,0,w]	y, $\bar{x},0$ [0,0,w]
2 c 4..	0,0,z [0,0,w]	0,0, \bar{z} [0,0,w]	
1 b 4/m..	0,0,1/2 [0,0,w]		
1 a 4/m..	0,0,0 [0,0,w]		

Symmetry of special projections

Along [001] 41'	Along [100] p2'mm'	Along [110] p2'mm'
Origin at 0,0,z	a* = c Origin at x,0,0	a* = c Origin at x,x,0

$p4/m1'$

$4/m1'$

Tetragonal

No. 28.2.141

$p4/m1'$

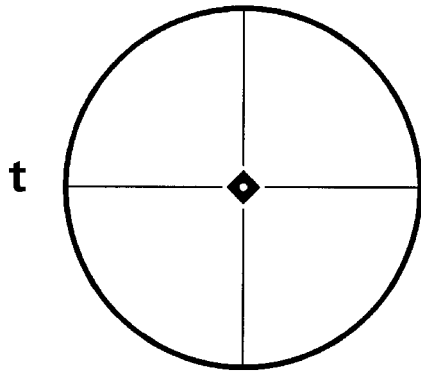

1'

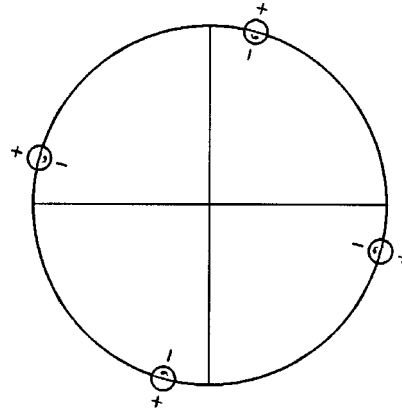

Origin at center ($4/m1'$)

Asymmetric unit $0 \leq x$; $0 \leq y$; $0 \leq z \leq 1/2$

Symmetry operations

For $1 +$ set

- | | | | |
|--|------------------------------------|---|--|
| (1) 1
($1 0,0,0$) | (2) 2 $0,0,z$
($2_z 0,0,0$) | (3) 4^+ $0,0,z$
($4_z 0,0,0$) | (4) 4^- $0,0,z$
($4_z^{-1} 0,0,0$) |
| (5) $\bar{1}$ $0,0,0$
($\bar{1} 0,0,0$) | (6) m $x,y,0$
($m_z 0,0,0$) | (7) $\bar{4}^+$ $0,0,z; 0,0,0$
($\bar{4}_z 0,0,0$) | (8) $\bar{4}^-$ $0,0,z; 0,0,0$
($\bar{4}_z^{-1} 0,0,0$) |

For $1' +$ set

- | | | | |
|--|--------------------------------------|---|--|
| (1) $1'$
($1 0,0,0$)' | (2) $2'$ $0,0,z$
($2_z 0,0,0$)' | (3) $4^{+'}$ $0,0,z$
($4_z 0,0,0$)' | (4) $4^{-'}$ $0,0,z$
($4_z^{-1} 0,0,0$)' |
| (5) $\bar{1}'$ $0,0,0$
($\bar{1} 0,0,0$)' | (6) m' $x,y,0$
($m_z 0,0,0$)' | (7) $\bar{4}^{+'}$ $0,0,z; 0,0,0$
($\bar{4}_z 0,0,0$)' | (8) $\bar{4}^{-'}$ $0,0,z; 0,0,0$
($\bar{4}_z^{-1} 0,0,0$)' |

Generators selected (1); $t(0,0,1)$; (2); (3); (5); $1'$

Positions

Multiplicity, Wyckoff letter, Site symmetry	Coordinates	
	$1+$	$1' +$
8 f $11'$	(1) x,y,z [0,0,0]	(2) \bar{x},\bar{y},z [0,0,0]
	(3) \bar{y},x,z [0,0,0]	(4) y,\bar{x},z [0,0,0]
	(5) \bar{x},\bar{y},\bar{z} [0,0,0]	(6) x,y,\bar{z} [0,0,0]
	(7) y,\bar{x},\bar{z} [0,0,0]	(8) \bar{y},x,\bar{z} [0,0,0]
4 e $m..1'$	$x,y,1/2$ [0,0,0]	$\bar{x},\bar{y},1/2$ [0,0,0]
	$\bar{y},x,1/2$ [0,0,0]	$y,\bar{x},1/2$ [0,0,0]
4 d $m..1'$	$x,y,0$ [0,0,0]	$\bar{x},\bar{y},0$ [0,0,0]
	$\bar{y},x,0$ [0,0,0]	$y,\bar{x},0$ [0,0,0]
2 c $4..1'$	$0,0,z$ [0,0,0]	$0,0,\bar{z}$ [0,0,0]
1 b $4/m..1'$	$0,0,1/2$ [0,0,0]	
1 a $4/m..1'$	$0,0,0$ [0,0,0]	

Symmetry of special projections

Along [001] $41'$	Along [100] $p2mm1'$	Along [110] $p2mm1'$
Origin at $0,0,z$	$a^* = c$ Origin at $x,0,0$	$a^* = c$ Origin at $x,x,0$

$p4/m'$

No. 28.3.142

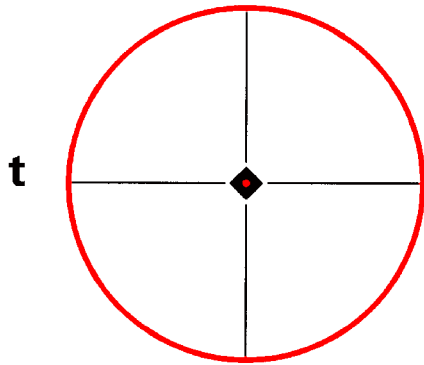

$4/m'$

$p4/m'$

Tetragonal

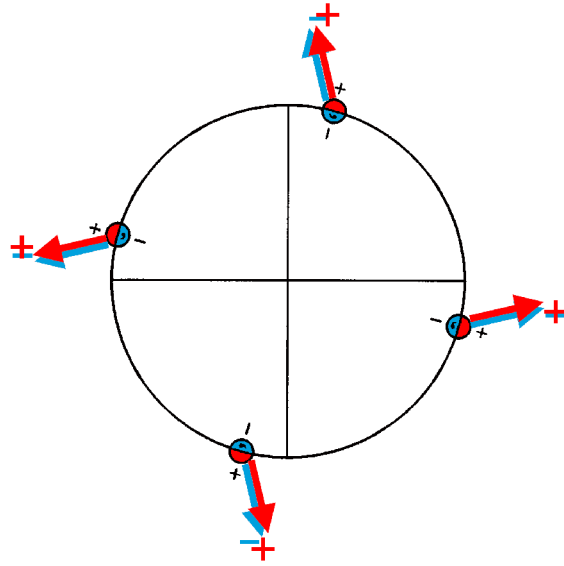

Origin at center ($4/m'$)

Asymmetric unit $0 \leq x$; $0 \leq y$; $0 \leq z \leq 1/2$

Symmetry operations

(1) 1
(1|0,0,0)

(2) $2_{0,0,z}$
(2_z |0,0,0)

(3) 4^+ 0,0,z
(4_z |0,0,0)

(4) 4^- 0,0,z
(4_z^{-1} |0,0,0)

(5) $\bar{1}$ 0,0,0
($\bar{1}$ |0,0,0)

(6) m' x,y,0
(m_z |0,0,0)

(7) $\bar{4}^+$ 0,0,z; 0,0,0
($\bar{4}_z$ |0,0,0)

(8) $\bar{4}^-$ 0,0,z; 0,0,0
($\bar{4}_z^{-1}$ |0,0,0)

Generators selected (1); $t(0,0,1)$; (2); (3); (5)

Positions

Multiplicity, Wyckoff letter, Site symmetry	Coordinates		
8 f 1	(1) x,y,z [u,v,w]	(2) \bar{x},\bar{y},z [\bar{u},\bar{v},w]	
	(3) \bar{y},x,z [\bar{v},u,w]	(4) y,\bar{x},z [v,\bar{u},w]	
	(5) \bar{x},\bar{y},\bar{z} [\bar{u},\bar{v},\bar{w}]	(6) x,y,\bar{z} [u,v, \bar{w}]	
	(7) y,\bar{x},\bar{z} [v,\bar{u},\bar{w}]	(8) \bar{y},x,\bar{z} [\bar{v},u,\bar{w}]	
	4 e $m'..$	$x,y,1/2$ [u,v,0]	$\bar{x},\bar{y},1/2$ [$\bar{u},\bar{v},0$]
		$\bar{y},x,1/2$ [$\bar{v},u,0$]	$y,\bar{x},1/2$ [$v,\bar{u},0$]
	4 d $m'..$	$x,y,0$ [u,v,0]	$\bar{x},\bar{y},0$ [$\bar{u},\bar{v},0$]
		$\bar{y},x,0$ [$\bar{v},u,0$]	$y,\bar{x},0$ [$v,\bar{u},0$]
2 c 4..	$0,0,z$ [0,0,w]	$0,0,\bar{z}$ [0,0, \bar{w}]	
1 b $4/m'..$	$0,0,1/2$ [0,0,0]		
1 a $4/m'..$	$0,0,0$ [0,0,0]		

Symmetry of special projections

Along [001] 4	Along [100] $p2m'm'$ $a^* = c$	Along [110] $p2m'm'$ $a^* = c$
Origin at 0,0,z	Origin at x,0,0	Origin at x,x,0

$p4'/m'$

No. 28.4.143

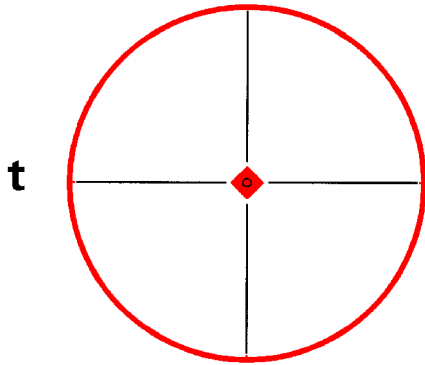

$4'/m'$

$p4'/m'$

Tetragonal

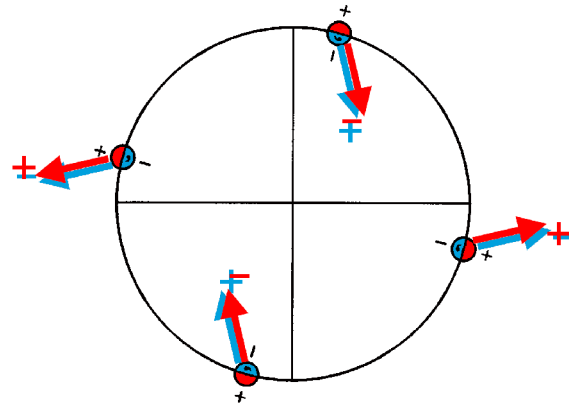

Origin at center ($4'/m'$)

Asymmetric unit $0 \leq x$; $0 \leq y$; $0 \leq z \leq 1/2$

Symmetry operations

- | | | | |
|---|--------------------------------------|---|--|
| (1) 1
(1 0,0,0) | (2) 2 $0,0,z$
(2_z 0,0,0) | (3) 4^{+} $0,0,z$
(4_z 0,0,0)' | (4) 4^{-} $0,0,z$
(4_z^{-1} 0,0,0)' |
| (5) $\bar{1}$ $0,0,0$
($\bar{1}$ 0,0,0)' | (6) m' $x,y,0$
(m_z 0,0,0)' | (7) $\bar{4}^{+}$ $0,0,z; 0,0,0$
($\bar{4}_z$ 0,0,0) | (8) $\bar{4}^{-}$ $0,0,z; 0,0,0$
($\bar{4}_z^{-1}$ 0,0,0) |

Generators selected (1); $t(0,0,1)$; (2); (3); (5)

Positions

Multiplicity, Wyckoff letter, Site symmetry	Coordinates		
8 f 1	(1) x,y,z [u,v,w]	(2) \bar{x},\bar{y},z [\bar{u},\bar{v},w]	
	(3) \bar{y},x,z [v,\bar{u},\bar{w}]	(4) y,\bar{x},z [\bar{v},u,\bar{w}]	
	(5) \bar{x},\bar{y},\bar{z} [\bar{u},\bar{v},\bar{w}]	(6) x,y,\bar{z} [u,v, \bar{w}]	
	(7) y,\bar{x},\bar{z} [\bar{v},u,w]	(8) \bar{y},x,\bar{z} [v,\bar{u},w]	
	4 e $m'..$	$x,y,1/2$ [u,v,0]	$\bar{x},\bar{y},1/2$ [$\bar{u},\bar{v},0$]
		$\bar{y},x,1/2$ [$v,\bar{u},0$]	$y,\bar{x},1/2$ [$\bar{v},u,0$]
	4 d $m'..$	$x,y,0$ [u,v,0]	$\bar{x},\bar{y},0$ [$\bar{u},\bar{v},0$]
		$\bar{y},x,0$ [$v,\bar{u},0$]	$y,\bar{x},0$ [$\bar{v},u,0$]
2 c $4'..$	$0,0,z$ [0,0,0]	$0,0,\bar{z}$ [0,0,0]	
1 b $4'/m'..$	$0,0,1/2$ [0,0,0]		
1 a $4'/m'..$	$0,0,0$ [0,0,0]		

Symmetry of special projections

Along [001] $4'$	Along [100] $p2m'm'$	Along [110] $p2m'm'$
Origin at 0,0,z	$a^* = c$ Origin at x,0,0	$a^* = c$ Origin at x,x,0

$p4'/m$

No. 28.5.144

$4'/m$

$p4'/m$

Tetragonal

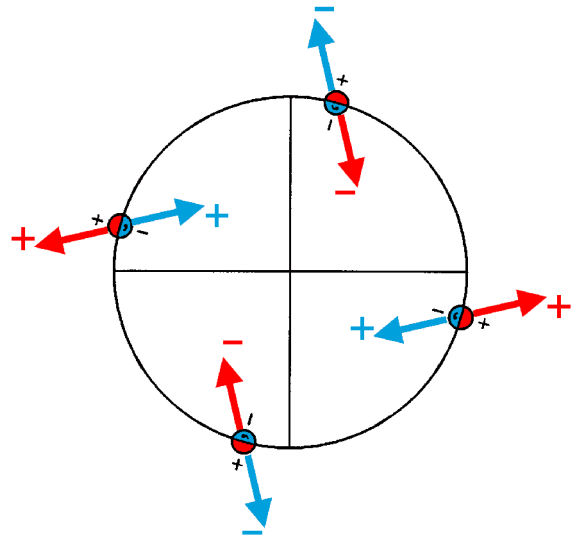
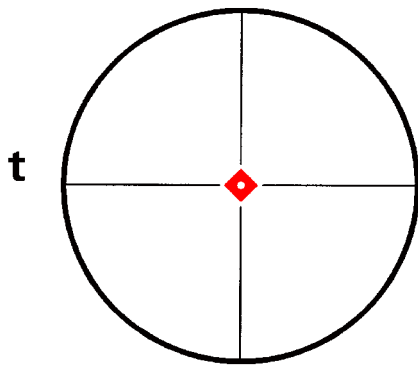

Origin at center ($4'/m$)

Asymmetric unit $0 \leq x$; $0 \leq y$; $0 \leq z \leq 1/2$

Symmetry operations

- | | | | |
|--|----------------------------------|--|---|
| (1) 1
(1 0,0,0) | (2) 2 $0,0,z$
(2_z 0,0,0) | (3) 4^{+} $0,0,z$
(4_z 0,0,0)' | (4) 4^{-} $0,0,z$
(4_z^{-1} 0,0,0)' |
| (5) $\bar{1}$ $0,0,0$
($\bar{1}$ 0,0,0) | (6) m $x,y,0$
(m_z 0,0,0) | (7) $\bar{4}^{+}$ $0,0,z; 0,0,0$
($\bar{4}_z$ 0,0,0)' | (8) $\bar{4}^{-}$ $0,0,z; 0,0,0$
($\bar{4}_z^{-1}$ 0,0,0)' |

Generators selected (1); $t(0,0,1)$; (2); (3); (5)

Positions

Multiplicity, Wyckoff letter, Site symmetry	Coordinates		
8 f 1	(1) x,y,z [u,v,w]	(2) \bar{x},\bar{y},z [\bar{u},\bar{v},w]	
	(3) \bar{y},x,z [v,\bar{u},\bar{w}]	(4) y,\bar{x},z [\bar{v},u,\bar{w}]	
	(5) \bar{x},\bar{y},\bar{z} [u,v,w]	(6) x,y,\bar{z} [\bar{u},\bar{v},w]	
	(7) y,\bar{x},\bar{z} [v,\bar{u},\bar{w}]	(8) \bar{y},x,\bar{z} [\bar{v},u,\bar{w}]	
	4 e m..	$x,y,1/2$ [$0,0,w$]	$\bar{x},\bar{y},1/2$ [$0,0,w$]
		$\bar{y},x,1/2$ [$0,0,\bar{w}$]	$y,\bar{x},1/2$ [$0,0,\bar{w}$]
	4 d m..	$x,y,0$ [$0,0,w$]	$\bar{x},\bar{y},0$ [$0,0,w$]
		$\bar{y},x,0$ [$0,0,\bar{w}$]	$y,\bar{x},0$ [$0,0,\bar{w}$]
2 c 4'..	$0,0,z$ [$0,0,0$]	$0,0,\bar{z}$ [$0,0,0$]	
1 b 4'/m..	$0,0,1/2$ [$0,0,0$]		
1 a 4'/m..	$0,0,0$ [$0,0,0$]		

Symmetry of special projections

Along [001] $41'$	Along [100] $p2'mm'$ $a^* = c$	Along [110] $p2'mm'$ $a^* = c$
Origin at $0,0,z$	Origin at $x,0,0$	Origin at $x,x,0$

$p_{2c}4'/m$

No. 28.6.145

$4/m1'$

$p_{2c}4'/m$

Tetragonal

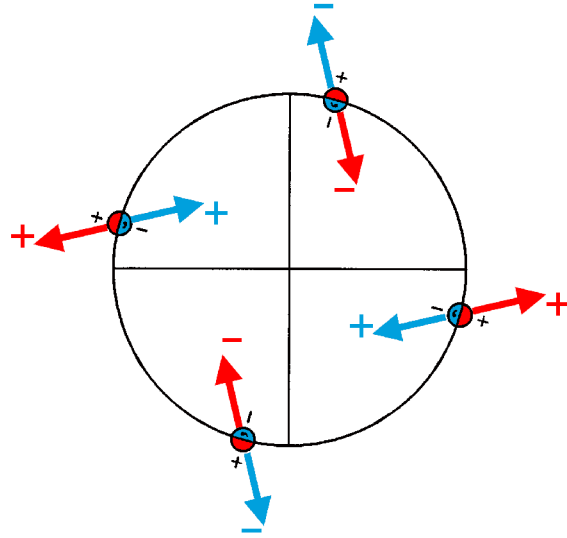
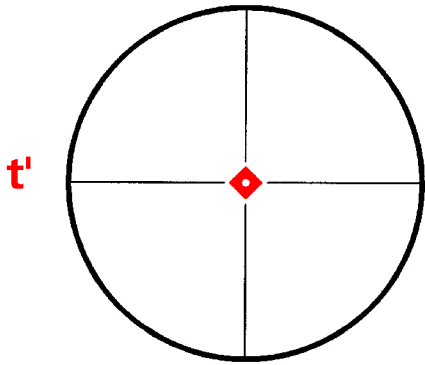

Origin at center ($4'/m$)

Asymmetric unit $0 \leq x; 0 \leq y; 0 \leq z \leq 1/2$

Symmetry operations

For $(0,0,0)^+$ set

- | | | | |
|--|--|--|--|
| (1) 1
(1 0,0,0) | (2) 2 $0,0,z$
(2 _z 0,0,0) | (3) 4 ⁺ $0,0,z$
(4 _z 0,0,0)' | (4) 4 ⁻ $0,0,z$
(4 _z ⁻¹ 0,0,0)' |
| (5) $\bar{1}$ $0,0,0$
($\bar{1}$ 0,0,0) | (6) m $x,y,0$
(m _z 0,0,0) | (7) $\bar{4}^{+}$ $0,0,z; 0,0,0$
($\bar{4}_z$ 0,0,0)' | (8) $\bar{4}^{-}$ $0,0,z; 0,0,0$
($\bar{4}_z^{-1}$ 0,0,0)' |

For $(0,0,1)'$ set

- | | | | |
|--|---|--|--|
| (1) t' $(0,0,1)$
(1 0,0,1)' | (2) 2' $(0,0,1) 0,0,z$
(2 _z ' 0,0,1)' | (3) 4 ⁺ $(0,0,1) 0,0,z$
(4 _z ' 0,0,1) | (4) 4 ⁻ $(0,0,1) 0,0,z$
(4 _z ⁻¹ ' 0,0,1) |
| (5) $\bar{1}$ ' $0,0,1/2$
($\bar{1}$ ' 0,0,1)' | (6) m' $x,y,1/2$
(m _z ' 0,0,1)' | (7) $\bar{4}^{+}$ ' $0,0,z; 0,0,1/2$
($\bar{4}_z$ ' 0,0,1) | (8) $\bar{4}^{-}$ ' $0,0,z; 0,0,1/2$
($\bar{4}_z^{-1}$ ' 0,0,1) |

Generators selected (1); $t(0,0,1)'$; (2); (3); (5)

Positions

Multiplicity, Wyckoff letter, Site symmetry	Coordinates	
	(0,0,0)+	(0,0,1)' +
8 f 1	(1) x,y,z [u,v,w] (3) \bar{y},x,z [v, \bar{u} , \bar{w}] (5) \bar{x},\bar{y},\bar{z} [u,v,w] (7) y,\bar{x},\bar{z} [v, \bar{u} , \bar{w}]	(2) \bar{x},\bar{y},z [\bar{u} , \bar{v} ,w] (4) y,\bar{x},z [\bar{v} ,u, \bar{w}] (6) x,y,\bar{z} [\bar{u} , \bar{v} ,w] (8) \bar{y},x,\bar{z} [\bar{v} ,u, \bar{w}]
4 e m'..	$x,y,1/2$ [u,v,0] $\bar{y},x,1/2$ [v, \bar{u} ,0]	$\bar{x},\bar{y},1/2$ [\bar{u} , \bar{v} ,0] $y,\bar{x},1/2$ [\bar{v} ,u,0]
4 d m..	$x,y,0$ [0,0,w] $\bar{y},x,0$ [0,0, \bar{w}]	$\bar{x},\bar{y},0$ [0,0,w] $y,\bar{x},0$ [0,0, \bar{w}]
2 c 4'..	$0,0,z$ [0,0,0]	$0,0,\bar{z}$ [0,0,0]
1 b 4'/m'..	$0,0,1/2$ [0,0,0]	
1 a 4'/m..	$0,0,0$ [0,0,0]	

Symmetry of special projections

Along [001] $41'$	Along [100] $p_{2a^*} 2'mm'$ $a^* = c$	Along [110] $p_{2a^*} 2'mm'$ $a^* = c$
Origin at 0,0,z	Origin at x,0,0	Origin at x,x,0

$p_{2c}4/m$

$4/m1'$

Tetragonal

No. 28.7.146

$p_{2c}4/m$

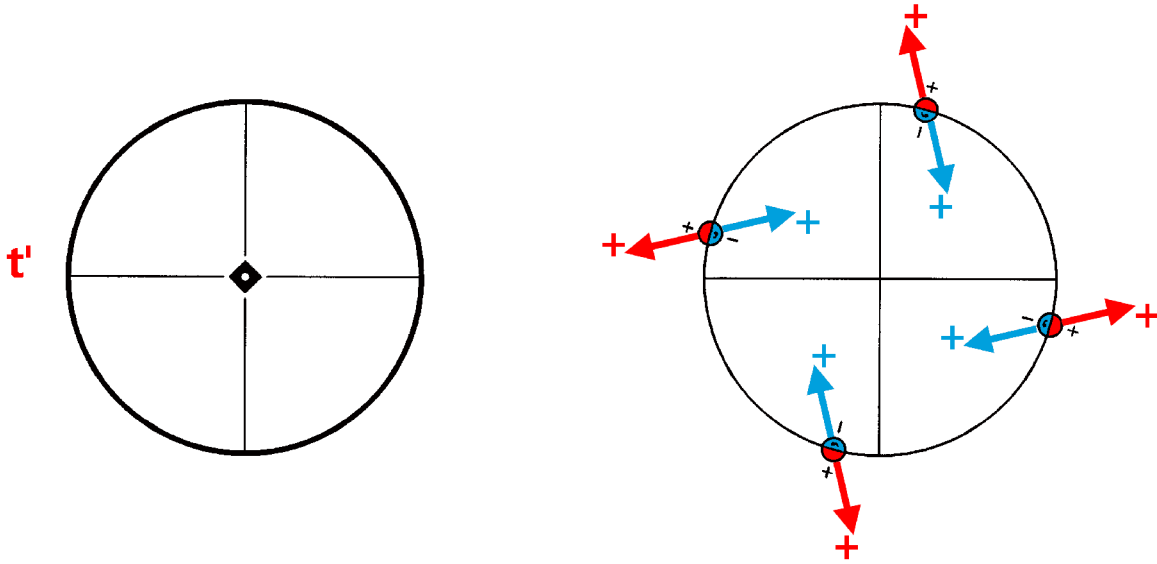

Origin at center ($4/m$)

Asymmetric unit $0 \leq x$; $0 \leq y$; $0 \leq z \leq 1/2$

Symmetry operations

For $(0,0,0)$ + set

- | | | | |
|--|----------------------------------|---|--|
| (1) 1
(1 0,0,0) | (2) 2 $0,0,z$
(2_z 0,0,0) | (3) 4^+ $0,0,z$
(4_z 0,0,0) | (4) 4^- $0,0,z$
(4_z^{-1} 0,0,0) |
| (5) $\bar{1}$ $0,0,0$
($\bar{1}$ 0,0,0) | (6) m $x,y,0$
(m_z 0,0,0) | (7) $\bar{4}^+$ $0,0,z; 0,0,0$
($\bar{4}_z$ 0,0,0) | (8) $\bar{4}^-$ $0,0,z; 0,0,0$
($\bar{4}_z^{-1}$ 0,0,0) |

For $(0,0,1)'$ + set

- | | | | |
|--|--|---|--|
| (1) t' $(0,0,1)$
(1 0,0,1)' | (2) $2'$ $(0,0,1)$ $0,0,z$
(2_z 0,0,1)' | (3) $4^{+'}$ $(0,0,1)$ $0,0,z$
(4_z 0,0,1)' | (4) $4^{-'}$ $(0,0,1)$ $0,0,z$
(4_z^{-1} 0,0,1)' |
| (5) $\bar{1}'$ $0,0,1/2$
($\bar{1}$ 0,0,1)' | (6) m' $x,y,1/2$
(m_z 0,0,1)' | (7) $\bar{4}^{+'}$ $0,0,z; 0,0,1/2$
($\bar{4}_z$ 0,0,1)' | (8) $\bar{4}^{-'}$ $0,0,z; 0,0,1/2$
($\bar{4}_z^{-1}$ 0,0,1)' |

Generators selected (1); $t(0,0,1)'$; (2); (3); (5)

Positions

Multiplicity, Wyckoff letter, Site symmetry	Coordinates	
	(0,0,0)+	(0,0,1)' +
8 f 1	(1) x,y,z [u,v,w]	(2) \bar{x},\bar{y},z [\bar{u},\bar{v},w]
	(3) \bar{y},x,z [\bar{v},u,w]	(4) y,\bar{x},z [v,\bar{u},w]
	(5) \bar{x},\bar{y},\bar{z} [\bar{u},\bar{v},\bar{w}]	(6) x,y,\bar{z} [u,v,\bar{w}]
	(7) y,\bar{x},\bar{z} [\bar{v},\bar{u},\bar{w}]	(8) \bar{y},x,\bar{z} [\bar{v},\bar{u},\bar{w}]
4 e m'..	$x,y,1/2$ [u,v,0]	$\bar{x},\bar{y},1/2$ [$\bar{u},\bar{v},0$]
	$\bar{y},x,1/2$ [$\bar{v},u,0$]	$y,\bar{x},1/2$ [$v,\bar{u},0$]
4 d m..	$x,y,0$ [0,0,w]	$\bar{x},\bar{y},0$ [0,0,w]
	$\bar{y},x,0$ [0,0,w]	$y,\bar{x},0$ [0,0,w]
2 c 4..	$0,0,z$ [0,0,w]	$0,0,\bar{z}$ [0,0,w]
1 b $4/m'$..	$0,0,1/2$ [0,0,0]	
1 a $4/m$..	$0,0,0$ [0,0,w]	

Symmetry of special projections

Along [001] $41'$	Along [100] $p_{2a^*} 2'mm'$ $a^* = c$	Along [110] $p_{2a^*} 2'mm'$ $a^* = c$
Origin at 0,0,z	Origin at x,0,0	Origin at x,x,0

$p4_2/m$

No. 29.1.147

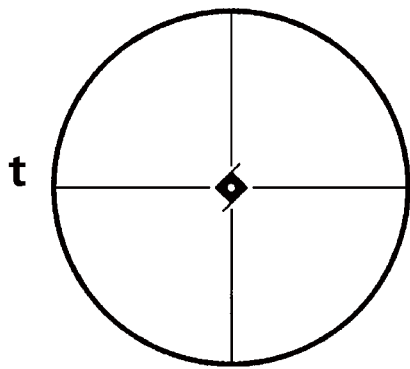

$4/m$

$p4_2/m$

Tetragonal

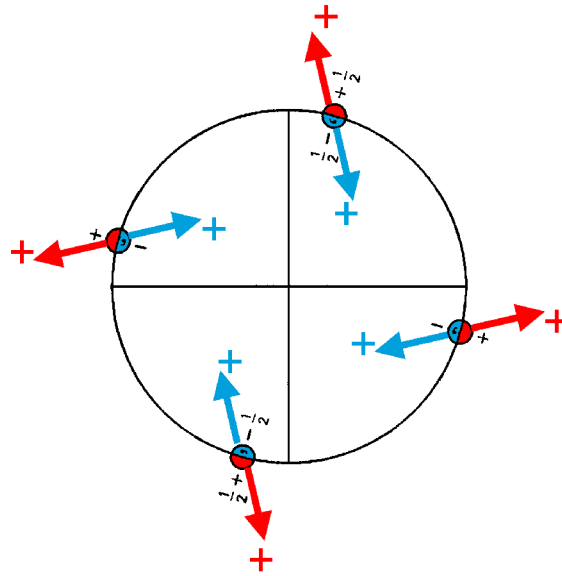

Origin at center ($2/m$) on 4_2

Asymmetric unit $0 \leq x; 0 \leq y; 0 \leq z \leq 1/2$

Symmetry operations

- | | | | |
|--|------------------------------------|---|--|
| (1) 1
(1 0,0,0) | (2) $2_{0,0,z}$
(2_z 0,0,0) | (3) $4^+(0,0,1/2)$ 0,0,z
(4_z 0,0,1/2) | (4) $4^-(0,0,1/2)$ 0,0,z
(4_z^{-1} 0,0,1/2) |
| (5) $\bar{1}$ 0,0,0
($\bar{1}$ 0,0,0) | (6) $m_{x,y,0}$
(m_z 0,0,0) | (7) $\bar{4}^+$ 0,0,z; 0,0,1/4
($\bar{4}_z$ 0,0,1/2) | (8) $\bar{4}^-$ 0,0,z; 0,0,1/4
($\bar{4}_z^{-1}$ 0,0,1/2) |

Generators selected (1); $t(0,0,1)$; (2); (3); (5)

Positions

	Coordinates		
Multiplicity, Wyckoff letter, Site symmetry			
8 e 1	(1) x,y,z [u,v,w]	(2) \bar{x},\bar{y},z [\bar{u},\bar{v},w]	
	(3) $\bar{y},x,z+1/2$ [\bar{v},u,w]	(4) $y,\bar{x},z+1/2$ [v,\bar{u},w]	
	(5) \bar{x},\bar{y},\bar{z} [u,v,w]	(6) x,y,\bar{z} [\bar{u},\bar{v},w]	
	(7) $y,\bar{x},\bar{z}+1/2$ [\bar{v},u,w]	(8) $\bar{y},x,\bar{z}+1/2$ [v,\bar{u},w]	
	4 d m..	$x,y,0$ [0,0,w]	$\bar{x},\bar{y},0$ [0,0,w]
		$\bar{y},x,1/2$ [0,0,w]	$y,\bar{x},1/2$ [0,0,w]
	4 c 2..	$0,0,z$ [0,0,w]	$0,0,z+1/2$ [0,0,w]
		$0,0,\bar{z}$ [0,0,w]	$0,0,\bar{z}+1/2$ [0,0,w]
2 b $\bar{4}$..	$0,0,1/4$ [0,0,w]	$0,0,3/4$ [0,0,w]	
2 a $2/m$..	$0,0,0$ [0,0,w]	$0,0,1/2$ [0,0,w]	

Symmetry of special projections

Along [001] $41'$	Along [100] $p2'mm'$	Along [110] $p2'mm'$
Origin at 0,0,z	$a^* = c$ Origin at x,0,0	$a^* = c$ Origin at x,x,0

$p4_2/m1'$

$4/m1'$

Tetragonal

No. 29.2.148

$p4_2/m1'$

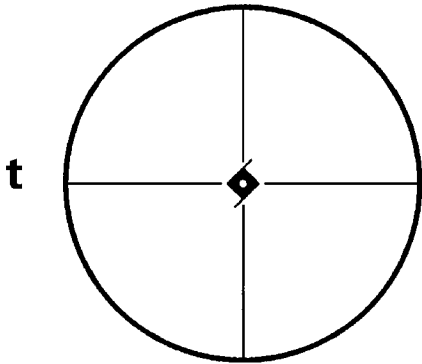

1'

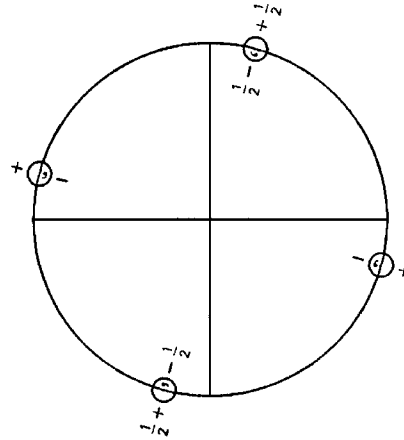

Origin at center ($2/m1'$) on 4_2

Asymmetric unit $0 \leq x; 0 \leq y; 0 \leq z \leq 1/2$

Symmetry operations

For $1 +$ set

- | | | | |
|--|------------------------------------|---|--|
| (1) 1
($1 0,0,0$) | (2) 2 $0,0,z$
($2_z 0,0,0$) | (3) 4^+ ($0,0,1/2$) $0,0,z$
($4_z 0,0,1/2$) | (4) $4^-(0,0,1/2)$ $0,0,z$
($4_z^{-1} 0,0,1/2$) |
| (5) $\bar{1}$ $0,0,0$
($\bar{1} 0,0,0$) | (6) m $x,y,0$
($m_z 0,0,0$) | (7) $\bar{4}^+$ $0,0,z; 0,0,1/4$
($\bar{4}_z 0,0,1/2$) | (8) $\bar{4}^-$ $0,0,z; 0,0,1/4$
($\bar{4}_z^{-1} 0,0,1/2$) |

For $1' +$ set

- | | | | |
|--|--------------------------------------|---|--|
| (1) $1'$
($1 0,0,0$)' | (2) $2'$ $0,0,z$
($2_z 0,0,0$)' | (3) $4^{+'}$ ($0,0,1/2$) $0,0,z$
($4_z 0,0,1/2$)' | (4) $4^{-'}$ ($0,0,1/2$) $0,0,z$
($4_z^{-1} 0,0,1/2$)' |
| (5) $\bar{1}'$ $0,0,0$
($\bar{1} 0,0,0$)' | (6) m' $x,y,0$
($m_z 0,0,0$)' | (7) $\bar{4}^{+'}$ $0,0,z; 0,0,1/4$
($\bar{4}_z 0,0,1/2$)' | (8) $\bar{4}^{-'}$ $0,0,z; 0,0,1/4$
($\bar{4}_z^{-1} 0,0,1/2$)' |

Generators selected (1); $t(0,0,1)$; (2); (3); (5); $1'$

Positions

Multiplicity, Wyckoff letter, Site symmetry	Coordinates	
	$1+$	$1' +$
8 e $11'$	(1) x,y,z [0,0,0]	(2) \bar{x},\bar{y},z [0,0,0]
	(3) $\bar{y},x,z+1/2$ [0,0,0]	(4) $y,\bar{x},z+1/2$ [0,0,0]
	(5) \bar{x},\bar{y},\bar{z} [0,0,0]	(6) x,y,\bar{z} [0,0,0]
	(7) $y,\bar{x},\bar{z}+1/2$ [0,0,0]	(8) $\bar{y},x,\bar{z}+1/2$ [0,0,0]
4 d $m..1'$	$x,y,0$ [0,0,0]	$\bar{x},\bar{y},0$ [0,0,0]
	$\bar{y},x,1/2$ [0,0,0]	$y,\bar{x},1/2$ [0,0,0]
4 c $2..1'$	$0,0,z$ [0,0,0]	$0,0,z+1/2$ [0,0,0]
	$0,0,\bar{z}$ [0,0,0]	$0,0,\bar{z}+1/2$ [0,0,0]
2 b $\bar{4}..1'$	$0,0,1/4$ [0,0,0]	$0,0,3/4$ [0,0,0]
2 a $2/m..1'$	$0,0,0$ [0,0,0]	$0,0,1/2$ [0,0,0]

Symmetry of special projections

Along [001] $41'$	Along [100] $p2mm1'$	Along [110] $p2mm1'$
Origin at 0,0,z	$a^* = c$ Origin at x,0,0	$a^* = c$ Origin at x,x,0

$p4_2/m'$

No. 29.3.149

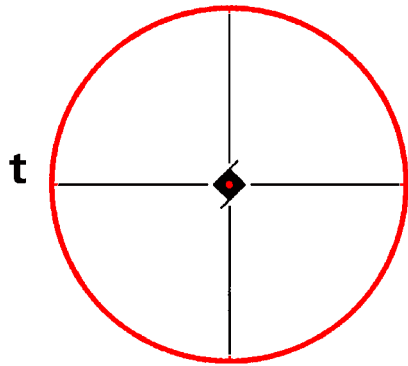

$4/m'$

$p4_2/m'$

Tetragonal

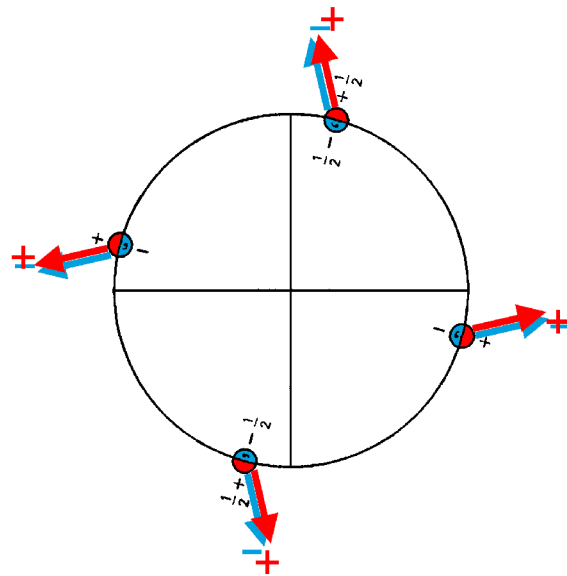

Origin at center ($2/m'$) on 4_2

Asymmetric unit $0 \leq x$; $0 \leq y$; $0 \leq z \leq 1/2$

Symmetry operations

(1) 1
(1|0,0,0)

(2) $2_{0,0,z}$
(2_z |0,0,0)

(3) $4^+(0,0,1/2)$ 0,0,z
(4_z |0,0,1/2)

(4) $4^-(0,0,1/2)$ 0,0,z
(4_z^{-1} |0,0,1/2)

(5) $\bar{1}$ 0,0,0
($\bar{1}$ |0,0,0)

(6) m'_x x,y,0
(m'_z |0,0,0)

(7) $\bar{4}^+$ 0,0,z; 0,0,1/4
($\bar{4}_z$ |0,0,1/2)

(8) $\bar{4}^-$ 0,0,z; 0,0,1/4
($\bar{4}_z^{-1}$ |0,0,1/2)

Generators selected (1); $t(0,0,1)$; (2); (3); (5)

Positions

	Coordinates		
Multiplicity, Wyckoff letter, Site symmetry			
8 e 1	(1) x,y,z [u,v,w]	(2) \bar{x},\bar{y},z [\bar{u},\bar{v},w]	
	(3) $\bar{y},x,z+1/2$ [\bar{v},u,w]	(4) $y,\bar{x},z+1/2$ [v,\bar{u},w]	
	(5) \bar{x},\bar{y},\bar{z} [\bar{u},\bar{v},\bar{w}]	(6) x,y,\bar{z} [u,v, \bar{w}]	
	(7) $y,\bar{x},\bar{z}+1/2$ [v,\bar{u},\bar{w}]	(8) $\bar{y},x,\bar{z}+1/2$ [\bar{v},u,\bar{w}]	
	4 d m' ..	$x,y,0$ [u,v,0]	$\bar{x},\bar{y},0$ [$\bar{u},\bar{v},0$]
		$\bar{y},x,1/2$ [$\bar{v},u,0$]	$y,\bar{x},1/2$ [$v,\bar{u},0$]
	4 c 2..	$0,0,z$ [0,0,w]	$0,0,z+1/2$ [0,0,w]
		$0,0,\bar{z}$ [0,0, \bar{w}]	$0,0,\bar{z}+1/2$ [0,0, \bar{w}]
2 b $\bar{4}'$..	$0,0,1/4$ [0,0,0]	$0,0,3/4$ [0,0,0]	
2 a $2/m'$..	$0,0,0$ [0,0,0]	$0,0,1/2$ [0,0,0]	

Symmetry of special projections

Along [001] 4	Along [100] $p2m'm'$ $a^* = c$	Along [110] $p2m'm'$ $a^* = c$
Origin at 0,0,z	Origin at x,0,0	Origin at x,x,0

$p4_2'/m'$

No. 29.4.150

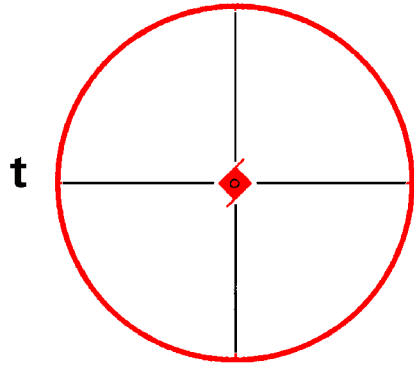

$4'/m'$

$p4_2'/m'$

Tetragonal

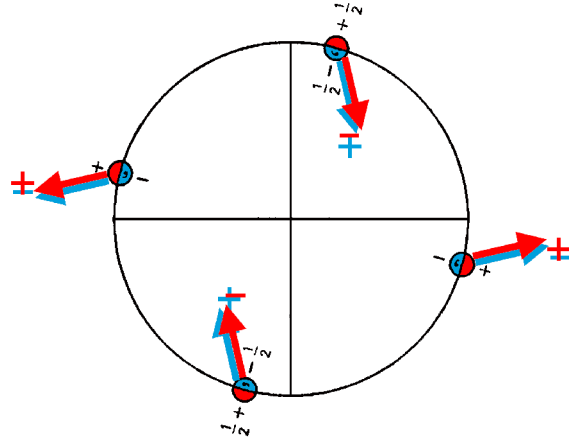

Origin at center ($2/m'$) on $4_2'$

Asymmetric unit $0 \leq x$; $0 \leq y$; $0 \leq z \leq 1/2$

Symmetry operations

(1) 1
(1|0,0,0)

(2) $2 \quad 0,0,z$
(2_z |0,0,0)

(3) $4^{+2} (0,0,1/2) \quad 0,0,z$
(4_z^{+2} |0,0,1/2)'

(4) $4^{-2} (0,0,1/2) \quad 0,0,z$
(4_z^{-2} |0,0,1/2)'

(5) $\bar{1}$ 0,0,0
($\bar{1}$ |0,0,0)'

(6) m' x,y,0
(m_z |0,0,0)'

(7) $\bar{4}^+ \quad 0,0,z; 0,0,1/4$
($\bar{4}_z^+$ |0,0,1/2)

(8) $\bar{4}^- \quad 0,0,z; 0,0,1/4$
($\bar{4}_z^-$ |0,0,1/2)

Generators selected (1); $t(0,0,1)$; (2); (3); (5)

Positions

	Coordinates		
Multiplicity, Wyckoff letter, Site symmetry			
8 e 1	(1) x,y,z [u,v,w]	(2) \bar{x},\bar{y},z [\bar{u},\bar{v},w]	
	(3) $\bar{y},x,z+1/2$ [v, \bar{u},\bar{w}]	(4) $y,\bar{x},z+1/2$ [\bar{v},u,\bar{w}]	
	(5) \bar{x},\bar{y},\bar{z} [\bar{u},\bar{v},\bar{w}]	(6) x,y,\bar{z} [u,v, \bar{w}]	
	(7) $y,\bar{x},\bar{z}+1/2$ [\bar{v},u,w]	(8) $\bar{y},x,\bar{z}+1/2$ [v, \bar{u},w]	
	4 d $m'..$	$x,y,0$ [u,v,0]	$\bar{x},\bar{y},0$ [$\bar{u},\bar{v},0$]
		$\bar{y},x,1/2$ [v, $\bar{u},0$]	$y,\bar{x},1/2$ [$\bar{v},u,0$]
	4 c $2..$	$0,0,z$ [0,0,w]	$0,0,z+1/2$ [0,0, \bar{w}]
		$0,0,\bar{z}$ [0,0, \bar{w}]	$0,0,\bar{z}+1/2$ [0,0,w]
2 b $\bar{4}..$	$0,0,1/4$ [0,0,w]	$0,0,3/4$ [0,0, \bar{w}]	
2 a $2/m'..$	$0,0,0$ [0,0,0]	$0,0,1/2$ [0,0,0]	

Symmetry of special projections

Along [001] $4'$	Along [100] $p2m'm'$	Along [110] $p2m'm'$
Origin at 0,0,z	$a^* = c$ Origin at x,0,0	$a^* = c$ Origin at x,x,0

$p4_2'/m$

No. 29.5.151

$4'/m$

$p4_2'/m$

Tetragonal

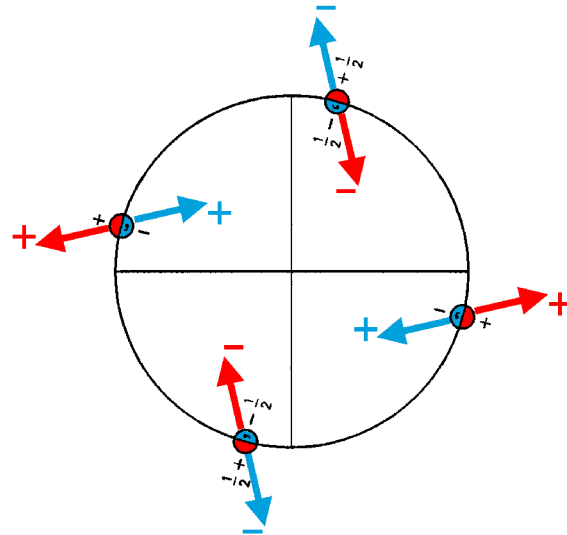
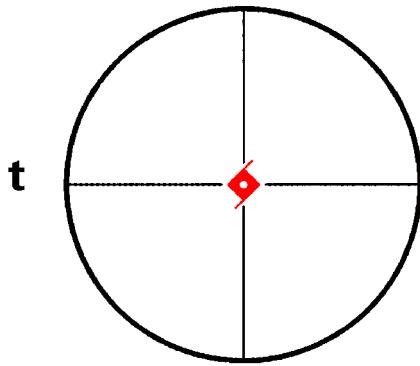

Origin at center ($2/m$) on $4_2'$

Asymmetric unit $0 \leq x$; $0 \leq y$; $0 \leq z \leq 1/2$

Symmetry operations

- | | | | |
|--|--|---|--|
| (1) 1
(1 0,0,0) | (2) 2_{z_2} 0,0,z
(2 _z 0,0,0) | (3) $4_2^{+'}$ (0,0,1/2) 0,0,z
(4 _z 0,0,1/2)' | (4) $4_2^{-'}$ (0,0,1/2) 0,0,z
(4 _z ⁻¹ 0,0,1/2)' |
| (5) $\bar{1}$ 0,0,0
($\bar{1}$ 0,0,0) | (6) m_{z_2} x,y,0
(m _z 0,0,0) | (7) $\bar{4}_2^{+'}$ 0,0,z; 0,0,1/4
($\bar{4}_z$ 0,0,1/2)' | (8) $\bar{4}_2^{-'}$ 0,0,z; 0,0,1/4
($\bar{4}_z^{-1}$ 0,0,1/2)' |

Generators selected (1); $t(0,0,1)$; (2); (3); (5)

Positions

	Coordinates		
Multiplicity, Wyckoff letter, Site symmetry			
8 e 1	(1) x,y,z [u,v,w]	(2) \bar{x},\bar{y},z [\bar{u},\bar{v},w]	
	(3) $\bar{y},x,z+1/2$ [v, \bar{u},\bar{w}]	(4) $y,\bar{x},z+1/2$ [\bar{v},u,\bar{w}]	
	(5) \bar{x},\bar{y},\bar{z} [u,v,w]	(6) x,y,\bar{z} [\bar{u},\bar{v},w]	
	(7) $y,\bar{x},\bar{z}+1/2$ [v, \bar{u},\bar{w}]	(8) $\bar{y},x,\bar{z}+1/2$ [\bar{v},u,\bar{w}]	
	4 d m..	$x,y,0$ [0,0,w]	$\bar{x},\bar{y},0$ [0,0,w]
		$\bar{y},x,1/2$ [0,0, \bar{w}]	$y,\bar{x},1/2$ [0,0, \bar{w}]
	4 c 2..	$0,0,z$ [0,0,w]	$0,0,z+1/2$ [0,0, \bar{w}]
		$0,0,\bar{z}$ [0,0,w]	$0,0,\bar{z}+1/2$ [0,0, \bar{w}]
2 b $\bar{4}'$..	$0,0,1/4$ [0,0,0]	$0,0,3/4$ [0,0,0]	
2 a $2/m$..	$0,0,0$ [0,0,w]	$0,0,1/2$ [0,0, \bar{w}]	

Symmetry of special projections

Along [001] $41'$	Along [100] $p2'mm'$	Along [110] $p2'mm'$
Origin at 0,0,z	$a^* = c$ Origin at x,0,0	$a^* = c$ Origin at x,x,0

p422

422

Tetragonal

No. 30.1.152

p422

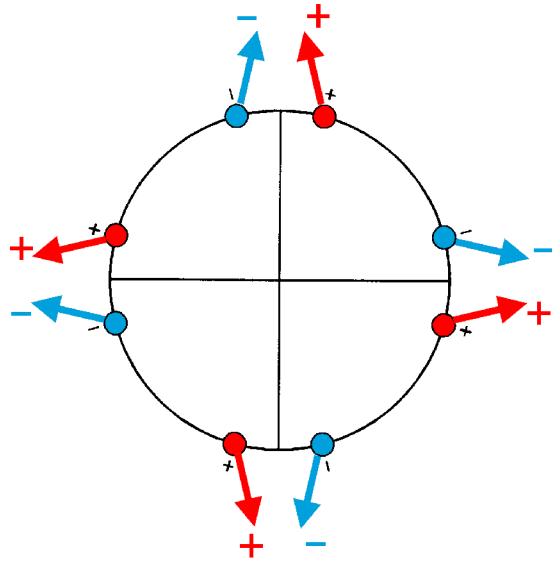
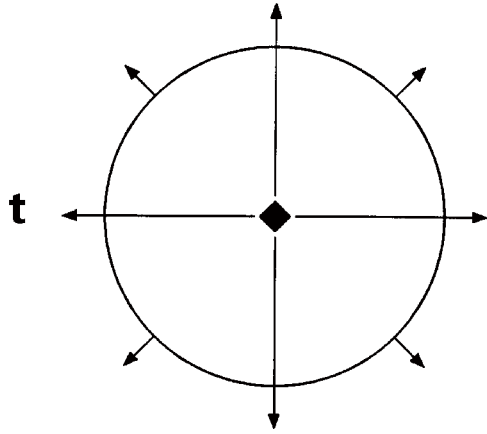

Origin at 422

Asymmetric unit $0 \leq x$; $0 \leq y$; $0 \leq z \leq 1/2$

Symmetry operations

- | | | | |
|--|--|--|--|
| (1) 1
(1 0,0,0) | (2) 2 0,0,z
(2 _z 0,0,0) | (3) 4 ⁺ 0,0,z
(4 _z ⁺ 0,0,0) | (4) 4 ⁻ 0,0,z
(4 _z ⁻ 0,0,0) |
| (5) 2 0,y,0
(2 _y 0,0,0) | (6) 2 x,0,0
(2 _x 0,0,0) | (7) 2 x,x,0
(2 _{xy} 0,0,0) | (8) 2 x,x̄,0
(2 _{x̄y} 0,0,0) |

Generators selected (1); $t(0,0,1)$; (2); (3); (5)

Positions

	Coordinates		
Multiplicity, Wyckoff letter, Site symmetry			
8 h 1	(1) x,y,z [u,v,w]	(2) \bar{x},\bar{y},z [\bar{u},\bar{v},w]	
	(3) \bar{y},x,z [\bar{v},u,w]	(4) y,\bar{x},z [v,\bar{u},w]	
	(5) \bar{x},y,\bar{z} [\bar{u},v,\bar{w}]	(6) x,\bar{y},\bar{z} [u,\bar{v},\bar{w}]	
	(7) y,x,\bar{z} [v,u,\bar{w}]	(8) \bar{y},\bar{x},\bar{z} [\bar{v},\bar{u},\bar{w}]	
	4 g .2.	$x,0,1/2$ [u,0,0]	$\bar{x},0,1/2$ [$\bar{u},0,0$]
		$0,x,1/2$ [0,u,0]	$0,\bar{x},1/2$ [0, $\bar{u},0$]
	4 f .2.	$x,0,0$ [u,0,0]	$\bar{x},0,0$ [$\bar{u},0,0$]
		$0,x,0$ [0,u,0]	$0,\bar{x},0$ [0, $\bar{u},0$]
4 e ..2	$x,x,1/2$ [u,u,0]	$\bar{x},\bar{x},1/2$ [$\bar{u},\bar{u},0$]	
	$\bar{x},x,1/2$ [$\bar{u},u,0$]	$x,\bar{x},1/2$ [$u,\bar{u},0$]	
4 d ..2	$x,x,0$ [u,u,0]	$\bar{x},\bar{x},0$ [$\bar{u},\bar{u},0$]	
	$\bar{x},x,0$ [$\bar{u},u,0$]	$x,\bar{x},0$ [$u,\bar{u},0$]	
2 c 4..	$0,0,z$ [0,0,w]	$0,0,\bar{z}$ [0,0, \bar{w}]	
1 b 422	$0,0,1/2$ [0,0,0]		
1 a 422	$0,0,0$ [0,0,0]		

Symmetry of special projectionsAlong [001] $4m'm'$

Origin at 0,0,z

Along [100] $p2m'm'$ $a^* = c$

Origin at x,0,0

Along [110] $p2m'm'$ $a^* = c$

Origin at x,x,0

$p4221'$

$4221'$

Tetragonal

No. 30.2.153

$p4221'$

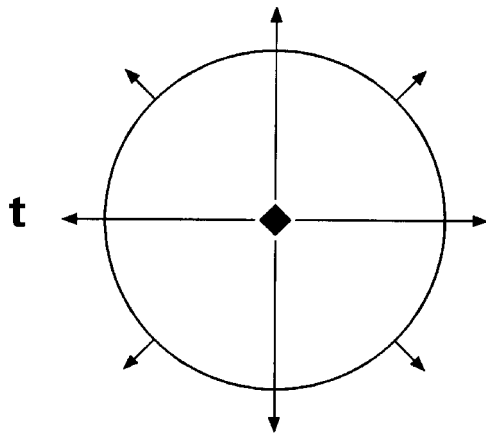

$1'$

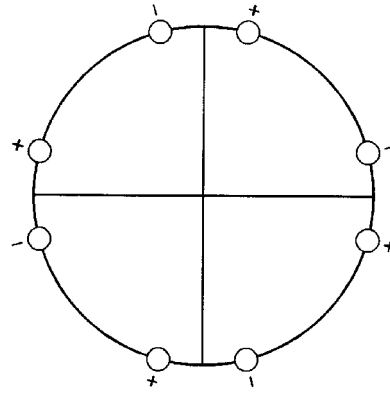

Origin at $4221'$

Asymmetric unit $0 \leq x; 0 \leq y; 0 \leq z \leq 1/2$

Symmetry operations

- | | | | |
|----------------------------------|----------------------------------|-------------------------------------|---|
| (1) 1
$(1 0,0,0)$ | (2) 2 $0,0,z$
$(2_z 0,0,0)$ | (3) 4^+ $0,0,z$
$(4_z 0,0,0)$ | (4) 4^- $0,0,z$
$(4_z^{-1} 0,0,0)$ |
| (5) 2 $0,y,0$
$(2_y 0,0,0)$ | (6) 2 $x,0,0$
$(2_x 0,0,0)$ | (7) 2 $x,x,0$
$(2_{xy} 0,0,0)$ | (8) 2 $x,\bar{x},0$
$(2_{\bar{xy}} 0,0,0)$ |

For $1'$ + set

- | | | | |
|------------------------------------|------------------------------------|--|---|
| (1) $1'$
$(1 0,0,0)'$ | (2) $2'$ $0,0,z$
$(2_z 0,0,0)'$ | (3) $4^{+'}$ $0,0,z$
$(4_z 0,0,0)'$ | (4) $4^{-'}$ $0,0,z$
$(4_z^{-1} 0,0,0)'$ |
| (5) $2'$ $0,y,0$
$(2_y 0,0,0)'$ | (6) $2'$ $x,0,0$
$(2_x 0,0,0)'$ | (7) $2'$ $x,x,0$
$(2_{xy} 0,0,0)'$ | (8) $2'$ $x,\bar{x},0$
$(2_{\bar{xy}} 0,0,0)'$ |

Generators selected (1); $t(0,0,1)$; (2); (3); (5); $1'$

Positions

Multiplicity, Wyckoff letter, Site symmetry	Coordinates	
	$1+$	$1'+$
8 h $11'$	(1) $x,y,z [0,0,0]$	(2) $\bar{x},\bar{y},z [0,0,0]$
	(3) $\bar{y},x,z [0,0,0]$	(4) $y,\bar{x},z [0,0,0]$
	(5) $\bar{x},y,\bar{z} [0,0,0]$	(6) $x,\bar{y},\bar{z} [0,0,0]$
	(7) $y,x,\bar{z} [0,0,0]$	(8) $\bar{y},\bar{x},\bar{z} [0,0,0]$
4 g $.2.1'$	$x,0,1/2 [0,0,0]$	$\bar{x},0,1/2 [0,0,0]$
	$0,x,1/2 [0,0,0]$	$0,\bar{x},1/2 [0,0,0]$
4 f $.2.1'$	$x,0,0 [0,0,0]$	$\bar{x},0,0 [0,0,0]$
	$0,x,0 [0,0,0]$	$0,\bar{x},0 [0,0,0]$
4 e $..21'$	$x,x,1/2 [0,0,0]$	$\bar{x},\bar{x},1/2 [0,0,0]$
	$\bar{x},x,1/2 [0,0,0]$	$x,\bar{x},1/2 [0,0,0]$
4 d $..21'$	$x,x,0 [0,0,0]$	$\bar{x},\bar{x},0 [0,0,0]$
	$\bar{x},x,0 [0,0,0]$	$x,\bar{x},0 [0,0,0]$
2 c $4..1'$	$0,0,z [0,0,0]$	$0,0,\bar{z} [0,0,0]$
1 b $4221'$	$0,0,1/2 [0,0,0]$	
1 a $4221'$	$0,0,0 [0,0,0]$	

Symmetry of special projectionsAlong $[001]$ $4mm1'$ Origin at $0,0,z$ Along $[100]$ $p2mm1'$ $a^* = c$ Origin at $x,0,0$ Along $[110]$ $p2mm1'$ $a^* = c$ Origin at $x,x,0$

$p42'2'$

No. 30.3.154

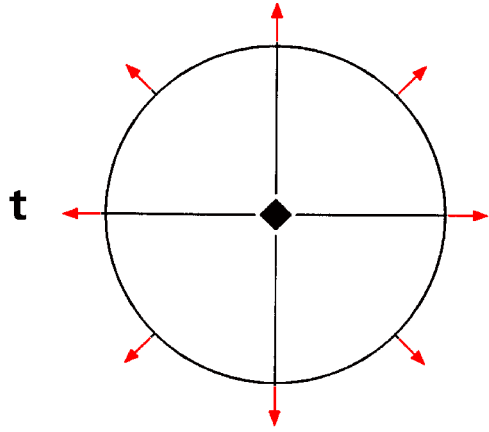

$42'2'$

$p42'2'$

Tetragonal

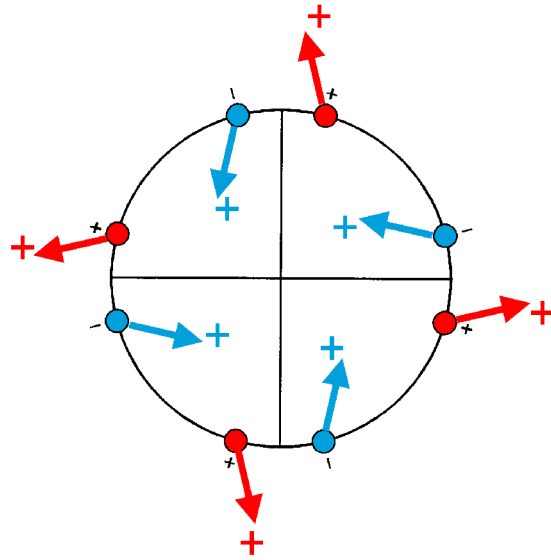

Origin at $42'2'$

Asymmetric unit $0 \leq x; 0 \leq y; 0 \leq z \leq 1/2$

Symmetry operations

- | | | | |
|--|--|---|--|
| (1) 1
(1 0,0,0) | (2) 2 0,0,z
(2 _z 0,0,0) | (3) 4 ⁺ 0,0,z
(4 _z 0,0,0) | (4) 4 ⁻ 0,0,z
(4 _z ⁻¹ 0,0,0) |
| (5) 2' 0,y,0
(2 _y 0,0,0)' | (6) 2' x,0,0
(2 _x 0,0,0)' | (7) 2' x,x,0
(2 _{xy} 0,0,0)' | (8) 2' x, \bar{x} ,0
(2 _{\bar{xy}} 0,0,0)' |

Generators selected (1); $t(0,0,1)$; (2); (3); (5)

Positions

	Coordinates		
Multiplicity, Wyckoff letter, Site symmetry			
8 h 1	(1) x,y,z [u,v,w]	(2) \bar{x},\bar{y},z [\bar{u},\bar{v},w]	
	(3) \bar{y},x,z [\bar{v},u,w]	(4) y,\bar{x},z [v,\bar{u},w]	
	(5) \bar{x},y,\bar{z} [u,\bar{v},w]	(6) x,\bar{y},\bar{z} [\bar{u},v,w]	
	(7) y,x,\bar{z} [\bar{v},\bar{u},w]	(8) \bar{y},\bar{x},\bar{z} [v,u,w]	
	4 g .2'	$x,0,1/2$ [$0,v,w$]	$\bar{x},0,1/2$ [$0,\bar{v},w$]
		$0,x,1/2$ [$\bar{v},0,w$]	$0,\bar{x},1/2$ [$v,0,w$]
	4 f .2'	$x,0,0$ [$0,v,w$]	$\bar{x},0,0$ [$0,\bar{v},w$]
		$0,x,0$ [$\bar{v},0,w$]	$0,\bar{x},0$ [$v,0,w$]
4 e ..2'	$x,x,1/2$ [u,\bar{u},w]	$\bar{x},\bar{x},1/2$ [\bar{u},u,w]	
	$\bar{x},x,1/2$ [u,u,w]	$x,\bar{x},1/2$ [\bar{u},\bar{u},w]	
4 d ..2'	$x,x,0$ [u,\bar{u},w]	$\bar{x},\bar{x},0$ [\bar{u},u,w]	
	$\bar{x},x,0$ [u,u,w]	$x,\bar{x},0$ [\bar{u},\bar{u},w]	
2 c 4..	$0,0,z$ [$0,0,w$]	$0,0,\bar{z}$ [$0,0,w$]	
1 b 42'2'	$0,0,1/2$ [$0,0,w$]		
1 a 42'2'	$0,0,0$ [$0,0,w$]		

Continued

No. 30.3.154

$p42'2'$

Symmetry of special projections

Along $[001]$ $4mm$

Origin at $0,0,z$

Along $[100]$ $p2'mm'$

$a^* = c$

Origin at $x,0,0$

Along $[110]$ $p2'mm'$

$a^* = c$

Origin at $x,x,0$

$p4'22'$

No. 30.4.155

$4'22'$

$p4'22'$

Tetragonal

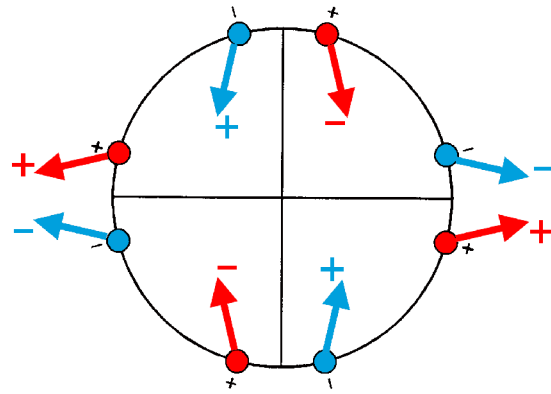
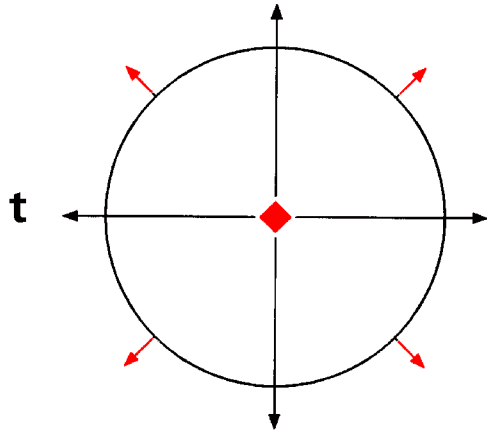

Origin at $4'22'$

Asymmetric unit $0 \leq x; 0 \leq y; 0 \leq z \leq 1/2$

Symmetry operations

- | | | | |
|----------------------------------|----------------------------------|---|---|
| (1) 1
(1 0,0,0) | (2) 2 $0,0,z$
(2_z 0,0,0) | (3) 4^{+} $0,0,z$
(4_z 0,0,0)' | (4) 4^{-} $0,0,z$
(4_z^{-1} 0,0,0)' |
| (5) 2 $0,y,0$
(2_y 0,0,0) | (6) 2 $x,0,0$
(2_x 0,0,0) | (7) $2'$ $x,x,0$
(2_{xy} 0,0,0)' | (8) $2'$ $x,\bar{x},0$
($2_{\bar{xy}}$ 0,0,0)' |

Generators selected (1); t(0,0,1); (2); (3); (5)

Positions

	Coordinates		
Multiplicity, Wyckoff letter, Site symmetry			
8 h 1	(1) x,y,z [u,v,w]	(2) \bar{x},\bar{y},z [\bar{u},\bar{v},w]	
	(3) \bar{y},x,z [v,\bar{u},\bar{w}]	(4) y,\bar{x},z [\bar{v},u,\bar{w}]	
	(5) \bar{x},y,\bar{z} [\bar{u},v,\bar{w}]	(6) x,\bar{y},\bar{z} [u,\bar{v},\bar{w}]	
	(7) y,x,\bar{z} [\bar{v},\bar{u},w]	(8) \bar{y},\bar{x},\bar{z} [v,u,w]	
	4 g .2.	x,0,1/2 [u,0,0]	$\bar{x},0,1/2$ [$\bar{u},0,0$]
		0,x,1/2 [0, \bar{u} ,0]	0, $\bar{x},1/2$ [0,u,0]
	4 f .2.	x,0,0 [u,0,0]	$\bar{x},0,0$ [$\bar{u},0,0$]
		0,x,0 [0, \bar{u} ,0]	0, $\bar{x},0$ [0,u,0]
4 e ..2'	x,x,1/2 [u, \bar{u} ,w]	$\bar{x},\bar{x},1/2$ [\bar{u},u,w]	
	$\bar{x},x,1/2$ [\bar{u},\bar{u},\bar{w}]	$x,\bar{x},1/2$ [u,u,\bar{w}]	
4 d ..2'	x,x,0 [u, \bar{u} ,w]	$\bar{x},\bar{x},0$ [\bar{u},u,w]	
	$\bar{x},x,0$ [\bar{u},\bar{u},\bar{w}]	$x,\bar{x},0$ [u,u,\bar{w}]	
2 c 4'..	0,0,z [0,0,0]	0,0, \bar{z} [0,0,0]	
1 b 4'22'	0,0,1/2 [0,0,0]		
1 a 4'22'	0,0,0 [0,0,0]		

Symmetry of special projectionsAlong [001] $4'm'm'$

Origin at 0,0,z

Along [100] $p2m'm'$ $a^* = c$

Origin at x,0,0

Along [110] $p2'mm'$ $a^* = c$

Origin at x,x,0

$p_{2c}4'22'$

4221'

Tetragonal

No. 30.5.156

$p_{2c}4'22'$

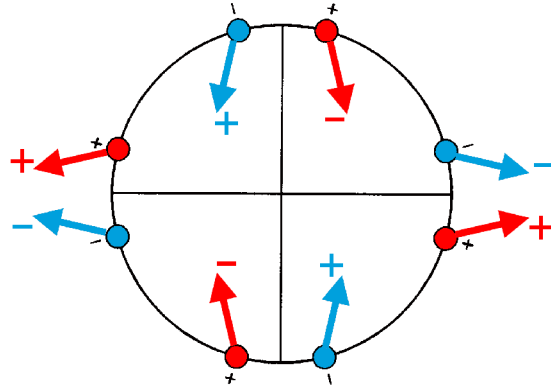
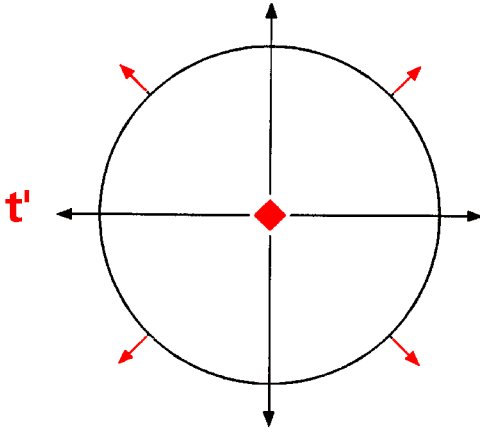

Origin at $4'22'$

Asymmetric unit $0 \leq x; 0 \leq y; 0 \leq z \leq 1/2$

Symmetry operations

For $(0,0,0)$ + set

- | | | | |
|--------------------|--|--|--|
| (1) 1
(1 0,0,0) | (2) 2 $0,0,z$
(2 _z 0,0,0) | (3) 4 ⁺ $0,0,z$
(4 _z 0,0,0)' | (4) 4 ⁻ $0,0,z$
(4 _z ⁻¹ 0,0,0)' |
|--------------------|--|--|--|

- | | | | |
|--|--|---|--|
| (5) 2 $0,y,0$
(2 _y 0,0,0) | (6) 2 $x,0,0$
(2 _x 0,0,0) | (7) 2' $x,x,0$
(2 _{xy} 0,0,0)' | (8) 2' $x,\bar{x},0$
(2 _{\bar{xy}}} 0,0,0)' |
|--|--|---|--|

For $(0,0,1)$ ' + set

- | | | | |
|--------------------------------|--|---|---|
| (1) t' $(0,0,1)$
(1 0,0,1)' | (2) 2' $(0,0,1)$ $0,0,z$
(2 _z 0,0,1)' | (3) 4 ⁺ $(0,0,1)$ $0,0,z$
(4 _z 0,0,1) | (4) 4 ⁻ $(0,0,1)$ $0,0,z$
(4 _z ⁻¹ 0,0,1) |
|--------------------------------|--|---|---|

- | | | | |
|--|--|---|--|
| (5) 2' $0,y,1/2$
(2 _y 0,0,1)' | (6) 2' $x,0,1/2$
(2 _x 0,0,1)' | (7) 2 $x,x,1/2$
(2 _{xy} 0,0,1) | (8) 2 $x,\bar{x},1/2$
(2 _{\bar{xy}}} 0,0,1) |
|--|--|---|--|

Generators selected (1); $t(0,0,1)'$; (2); (3); (5)

Positions

Multiplicity, Wyckoff letter, Site symmetry	Coordinates	
	(0,0,0)+	(0,0,1)' +
8 h 1	(1) x,y,z [u,v,w]	(2) \bar{x},\bar{y},z [\bar{u},\bar{v},w]
	(3) \bar{y},x,z [v, \bar{u},\bar{w}]	(4) y,\bar{x},z [\bar{v},u,\bar{w}]
	(5) \bar{x},y,\bar{z} [\bar{u},v,\bar{w}]	(6) x,\bar{y},\bar{z} [u, \bar{v},\bar{w}]
	(7) y,x,\bar{z} [\bar{v},\bar{u},w]	(8) \bar{y},\bar{x},\bar{z} [v,u,w]
4 g .2'	$x,0,1/2$ [0,v,w]	$\bar{x},0,1/2$ [0, \bar{v},w]
	$0,x,1/2$ [v,0, \bar{w}]	$0,\bar{x},1/2$ [$\bar{v},0,\bar{w}$]
4 f .2.	$x,0,0$ [u,0,0]	$\bar{x},0,0$ [$\bar{u},0,0$]
	$0,x,0$ [0, $\bar{u},0$]	$0,\bar{x},0$ [0,u,0]
4 e ..2	$x,x,1/2$ [u,u,0]	$\bar{x},\bar{x},1/2$ [$\bar{u},\bar{u},0$]
	$\bar{x},x,1/2$ [u, $\bar{u},0$]	$x,\bar{x},1/2$ [$\bar{u},u,0$]
4 d ..2'	$x,x,0$ [u, \bar{u},w]	$\bar{x},\bar{x},0$ [\bar{u},u,w]
	$\bar{x},x,0$ [\bar{u},\bar{u},\bar{w}]	$x,\bar{x},0$ [u,u, \bar{w}]
2 c 4'..	$0,0,z$ [0,0,0]	$0,0,\bar{z}$ [0,0,0]
1 b 4'2'2	$0,0,1/2$ [0,0,0]	
1 a 4'22'	$0,0,0$ [0,0,0]	

Continued

No. 30.5.156

$P_{2c} 4'22'$

Symmetry of special projections

Along [001] $4mm1'$

Origin at 0,0,z

Along [100] $P_{2a^*} 2m'm'$

$a^* = c$

Origin at x,0,0

Along [110] $P_{2a^*} 2m'm'$

$a^* = c$

Origin at x,x,1/2

$p_{2c}422$

4221'

Tetragonal

No. 30.6.157

$p_{2c}422$

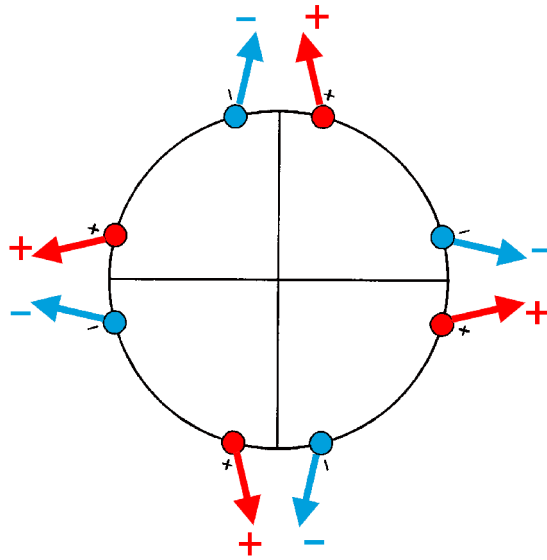
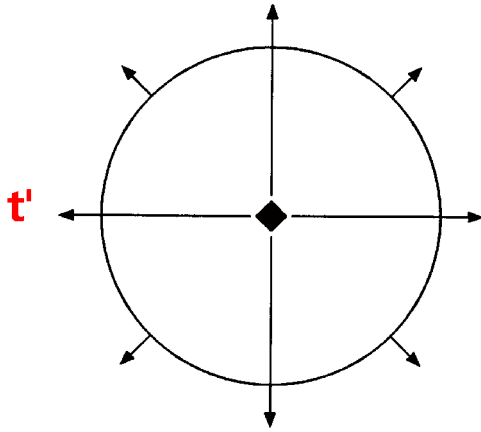

Origin at 422

Asymmetric unit $0 \leq x$; $0 \leq y$; $0 \leq z \leq 1/2$

Symmetry operations

For (0,0,0) + set

- | | | | |
|--|--|---|--|
| (1) 1
(1 0,0,0) | (2) 2 0,0,z
(2 _z 0,0,0) | (3) 4 ⁺ 0,0,z
(4 _z 0,0,0) | (4) 4 ⁻ 0,0,z
(4 _z ⁻¹ 0,0,0) |
| (5) 2 0,y,0
(2 _y 0,0,0) | (6) 2 x,0,0
(2 _x 0,0,0) | (7) 2 x,x,0
(2 _{xy} 0,0,0) | (8) 2 x, \bar{x} ,0
(2 _{\bar{xy}} 0,0,0) |

For (0,0,1)' + set

- | | | | |
|--|--|--|--|
| (1) t' (0,0,1)
(1 0,0,1)' | (2) 2' (0,0,1) 0,0,z
(2 _z 0,0,1)' | (3) 4 ⁺ ' (0,0,1) 0,0,z
(4 _z 0,0,1)' | (4) 4 ⁻ ' (0,0,1) 0,0,z
(4 _z ⁻¹ 0,0,1)' |
| (5) 2' 0,y,1/2
(2 _y 0,0,1)' | (6) 2' x,0,1/2
(2 _x 0,0,1)' | (7) 2' x,x,1/2
(2 _{xy} 0,0,1)' | (8) 2' x, \bar{x} ,1/2
(2 _{\bar{xy}} 0,0,1)' |

Generators selected (1); $t(0,0,1)'$; (2); (3); (5)

Positions

Multiplicity, Wyckoff letter, Site symmetry	Coordinates	
	(0,0,0)+	(0,0,1)' +
8 h 1	(1) x,y,z [u,v,w] (3) \bar{y},x,z [\bar{v} ,u,w] (5) \bar{x},y,\bar{z} [\bar{u} ,v, \bar{w}] (7) y,x,\bar{z} [v,u, \bar{w}]	(2) \bar{x},\bar{y},z [\bar{u} , \bar{v} ,w] (4) y,\bar{x},z [v, \bar{u} ,w] (6) x,\bar{y},\bar{z} [u, \bar{v} , \bar{w}] (8) \bar{y},\bar{x},\bar{z} [\bar{v} , \bar{u} , \bar{w}]
4 g .2'	$x,0,1/2$ [0,v,w] $0,x,1/2$ [\bar{v} ,0,w]	$\bar{x},0,1/2$ [0, \bar{v} ,w] $0,\bar{x},1/2$ [v,0,w]
4 f .2.	$x,0,0$ [u,0,0] $0,x,0$ [0,u,0]	$\bar{x},0,0$ [\bar{u} ,0,0] $0,\bar{x},0$ [0, \bar{u} ,0]
4 e ..2'	$x,x,1/2$ [u, \bar{u} ,w] $\bar{x},x,1/2$ [u,u,w]	$\bar{x},\bar{x},1/2$ [\bar{u} ,u,w] $x,\bar{x},1/2$ [\bar{u} , \bar{u} ,w]
4 d ..2	$x,x,0$ [u,u,0] $\bar{x},x,0$ [\bar{u} ,u,0]	$\bar{x},\bar{x},0$ [\bar{u} , \bar{u} ,0] $x,\bar{x},0$ [u, \bar{u} ,0]
2 c 4..	$0,0,z$ [0,0,w]	$0,0,\bar{z}$ [0,0, \bar{w}]
1 b 42'2'	$0,0,1/2$ [0,0,w]	
1 a 422	$0,0,0$ [0,0,0]	

Symmetry of special projectionsAlong [001] $4mm1'$

Origin at 0,0,z

Along [100] $p_{2a^*} 2m'm'$ $a^* = c$

Origin at x,0,0

Along [110] $p_{2a^*} 2m'm'$ $a^* = c$

Origin at x,x,0

$p4_122$

422

Tetragonal

No. 31.1.158

$p4_122$

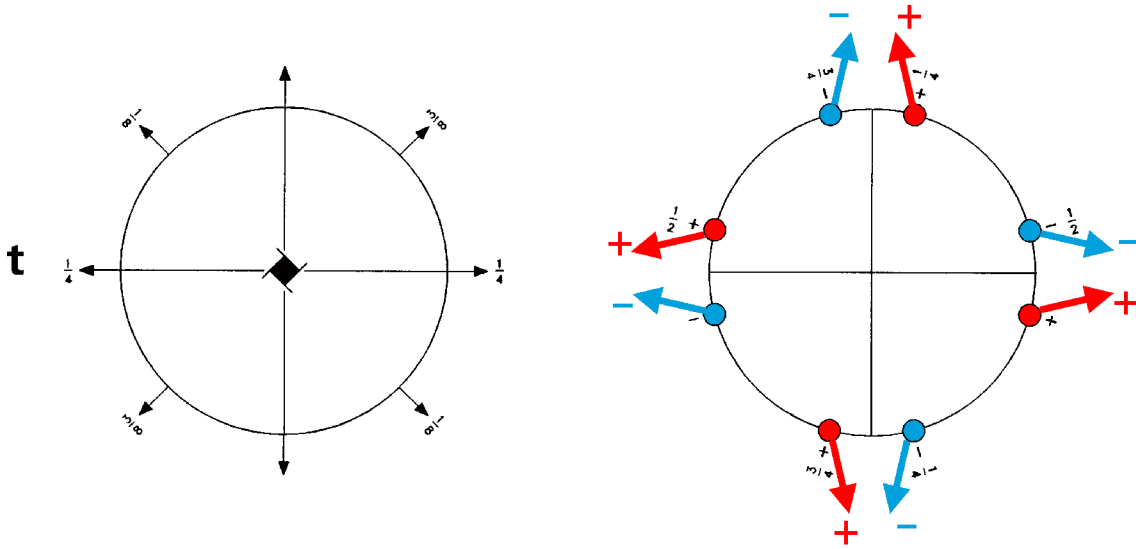

Origin on $2[100]$ at $4_1(2,1)1$

Asymmetric unit $0 \leq z \leq 1/8$

Symmetry operations

- | | | | |
|--|--|---|---|
| (1) 1
(1 0,0,0) | (2) 2 (0,0,1/2) 0,0,z
(2 _z 0,0,1/2) | (3) 4 ⁺ (0,0,1/4) 0,0,z
(4 _z 0,0,1/4) | (4) 4 ⁻ (0,0,3/4) 0,0,z
(4 _z ⁻¹ 0,0,3/4) |
| (5) 2 x,0,0
(2 _y 0,0,0) | (6) 2 0,y,1/4
(2 _x 0,0,1/2) | (7) 2 x,x,1/8
(2 _{xy} 0,0,1/4) | (8) 2 x, \bar{x} ,3/8
(2 _{\bar{xy}} 0,0,3/4) |

Generators selected (1); t(0,0,1); (2); (3); (5)

Positions

Multiplicity, Wyckoff letter, Site symmetry	Coordinates		
8 c 1	(1) x, y, z [u, v, w]	(2) $\bar{x}, \bar{y}, z + 1/2$ [\bar{u}, \bar{v}, w]	
	(3) $\bar{y}, x, z + 1/4$ [\bar{v}, u, w]	(4) $y, \bar{x}, z + 3/4$ [v, \bar{u}, w]	
	(5) x, \bar{y}, \bar{z} [u, \bar{v}, \bar{w}]	(6) $\bar{x}, y, \bar{z} + 1/2$ [\bar{u}, v, \bar{w}]	
	(7) $y, x, \bar{z} + 1/4$ [v, u, \bar{w}]	(8) $\bar{y}, \bar{x}, \bar{z} + 3/4$ [$\bar{v}, \bar{u}, \bar{w}$]	
	4 b ..2	$x, x, 1/8$ [u, u, 0]	$\bar{x}, \bar{x}, 5/8$ [$\bar{u}, \bar{u}, 0$]
		$\bar{x}, x, 3/8$ [$\bar{u}, u, 0$]	$x, \bar{x}, 7/8$ [$u, \bar{u}, 0$]
	4 a .2.	$x, 0, 0$ [u, 0, 0]	$\bar{x}, 0, 1/2$ [$\bar{u}, 0, 0$]
		$0, x, 1/4$ [0, u, 0]	$0, \bar{x}, 3/4$ [0, $\bar{u}, 0$]

Symmetry of special projections

Along [001] 4m'm'	Along [100] p2m'g' a* = c	Along [110] p2m'g' a* = c
Origin at 0,0,z	Origin at x,0,0	Origin at x,x,1/8

$p4_1221'$

4221'

Tetragonal

No. 31.2.159

$p4_1221'$

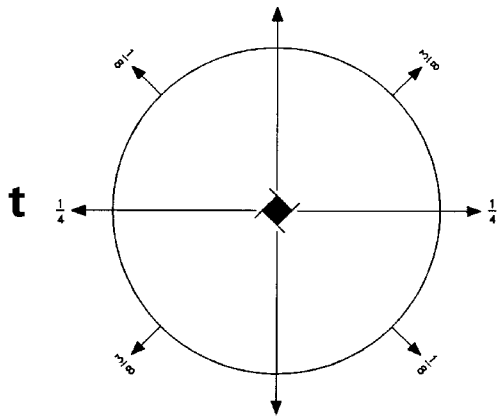

1'

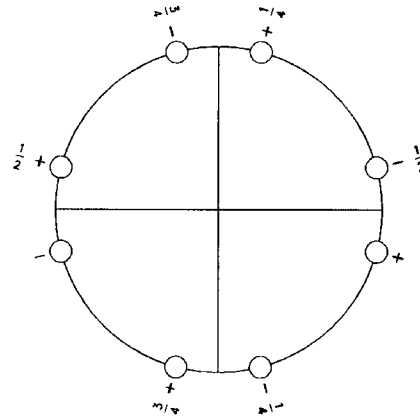

Origin on $21'[100]$ at $4_1(2,1)11'$

Asymmetric unit $0 \leq z \leq 1/8$

Symmetry operations

For 1 + set

- | | | | |
|--|--|---|---|
| (1) 1
(1 0,0,0) | (2) 2 (0,0,1/2) 0,0,z
(2 _z 0,0,1/2) | (3) 4 ⁺ (0,0,1/4) 0,0,z
(4 _z 0,0,1/4) | (4) 4 ⁻ (0,0,3/4) 0,0,z
(4 _z ⁻¹ 0,0,3/4) |
| (5) 2 x,0,0
(2 _y 0,0,0) | (6) 2 0,y,1/4
(2 _x 0,0,1/2) | (7) 2 x,x,1/8
(2 _{xy} 0,0,1/4) | (8) 2 x,x̄,3/8
(2 _{xy} 0,0,3/4) |

For 1' + set

- | | | | |
|--|--|--|--|
| (1) 1'
(1 0,0,0)' | (2) 2' (0,0,1/2) 0,0,z
(2 _z 0,0,1/2)' | (3) 4 ⁺ ' (0,0,1/4) 0,0,z
(4 _z 0,0,1/4)' | (4) 4 ⁻ ' (0,0,3/4) 0,0,z
(4 _z ⁻¹ 0,0,3/4)' |
| (5) 2' x,0,0
(2 _y 0,0,0)' | (6) 2' 0,y,1/4
(2 _x 0,0,1/2)' | (7) 2' x,x,1/8
(2 _{xy} 0,0,1/4)' | (8) 2' x,x̄,3/8
(2 _{xy} 0,0,3/4)' |

Generators selected (1); t(0,0,1); (2); (3); (5); 1'

Positions

Multiplicity, Wyckoff letter, Site symmetry	Coordinates	
	1+	1' +
8 c 11'	(1) x,y,z [0,0,0]	(2) $\bar{x},\bar{y},z+1/2$ [0,0,0]
	(3) $\bar{y},x,z+1/4$ [0,0,0]	(4) $y,\bar{x},z+3/4$ [0,0,0]
	(5) x,\bar{y},\bar{z} [0,0,0]	(6) $\bar{x},y,\bar{z}+1/2$ [0,0,0]
	(7) $y,x,\bar{z}+1/4$ [0,0,0]	(8) $\bar{y},\bar{x},\bar{z}+3/4$ [0,0,0]
4 b ..21'	$x,x,1/8$ [0,0,0]	$\bar{x},\bar{x},5/8$ [0,0,0]
	$\bar{x},x,3/8$ [0,0,0]	$x,\bar{x},7/8$ [0,0,0]
4 a .2.1'	$x,0,0$ [0,0,0]	$\bar{x},0,1/2$ [0,0,0]
	$0,x,1/4$ [0,0,0]	$0,\bar{x},3/4$ [0,0,0]

Symmetry of special projections

Along [001] 4mm1'	Along [100] p2mg1'	Along [110] p2mg1'
Origin at 0,0,z	a* = c Origin at x,0,0	a* = c Origin at x,x,1/8

$p4_12'2'$

$42'2'$

Tetragonal

No. 31.3.160

$p4_12'2'$

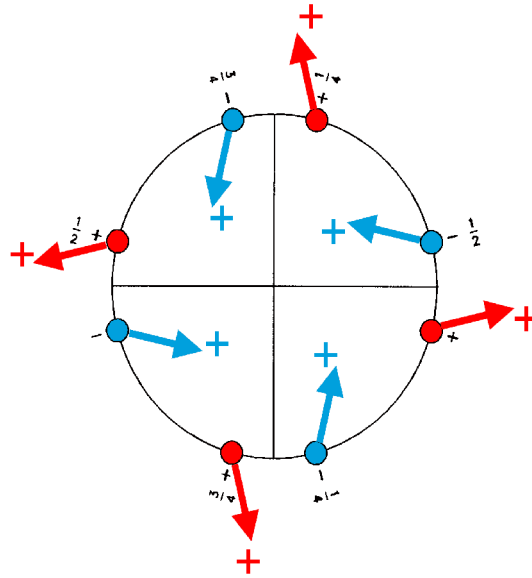
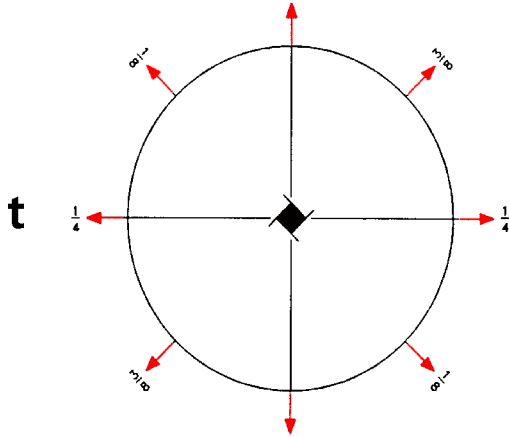

Origin on $2'[100]$ at $4_1(2',1)1$

Asymmetric unit $0 \leq z \leq 1/8$

Symmetry operations

- | | | | |
|--|--|---|---|
| (1) 1
(1 0,0,0) | (2) 2 (0,0,1/2) 0,0,z
(2 _z 0,0,1/2) | (3) 4 ⁺ (0,0,1/4) 0,0,z
(4 _z 0,0,1/4) | (4) 4 ⁻ (0,0,3/4) 0,0,z
(4 _z ⁻¹ 0,0,3/4) |
| (5) 2' x,0,0
(2 _y 0,0,0)' | (6) 2' 0,y,1/4
(2 _x 0,0,1/2)' | (7) 2' x,x,1/8
(2 _{xy} 0,0,1/4)' | (8) 2' x, \bar{x} ,3/8
(2 _{\bar{xy}} 0,0,3/4)' |

Generators selected (1); $t(0,0,1)$; (2); (3); (5)

Positions

	Coordinates		
Multiplicity, Wyckoff letter, Site symmetry			
8 c 1	(1) x, y, z [u,v,w]	(2) $\bar{x}, \bar{y}, z+1/2$ [\bar{u}, \bar{v}, w]	
	(3) $\bar{y}, x, z+1/4$ [\bar{v}, u, w]	(4) $y, \bar{x}, z+3/4$ [v, \bar{u}, w]	
	(5) x, \bar{y}, \bar{z} [\bar{u}, v, w]	(6) $\bar{x}, y, \bar{z}+1/2$ [u, \bar{v}, w]	
	(7) $y, x, \bar{z}+1/4$ [\bar{v}, \bar{u}, w]	(8) $\bar{y}, \bar{x}, \bar{z}+3/4$ [v, u, w]	
	4 b ..2'	$x, x, 1/8$ [u, \bar{u} ,w]	$\bar{x}, \bar{x}, 5/8$ [\bar{u}, u, w]
		$\bar{x}, x, 3/8$ [u,u,w]	$x, \bar{x}, 7/8$ [\bar{u}, \bar{u}, w]
	4 a .2.'	$x, 0, 0$ [0,v,w]	$\bar{x}, 0, 1/2$ [0, \bar{v}, w]
		$0, x, 1/4$ [$\bar{v}, 0, w$]	$0, \bar{x}, 3/4$ [$v, 0, w$]

Symmetry of special projections

Along [001] 4mm	Along [100] $p2'mg'$ $a^* = c$	Along [110] $p2'mg'$ $a^* = c$
Origin at 0,0,z	Origin at x,0,0	Origin at x,x,1/8

$p4_1'22'$

$4'22'$

Tetragonal

No. 31.4.161

$p4_1'22'$

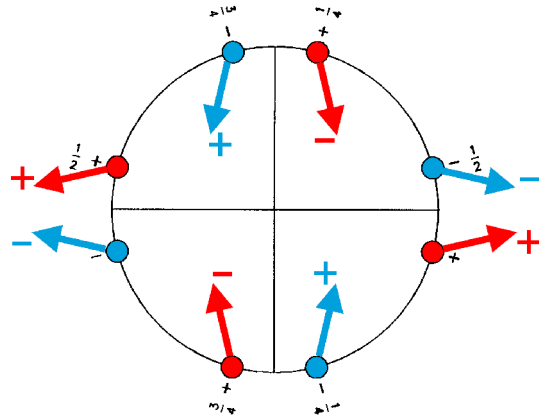
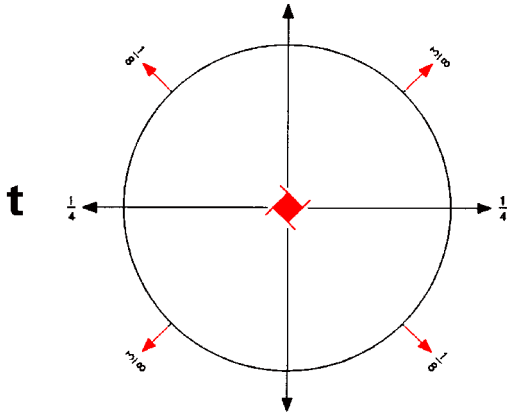

Origin on $2[100]$ at $4_1'(2,1)1$

Asymmetric unit $0 \leq z \leq 1/8$

Symmetry operations

- | | | | |
|--|--|--|--|
| (1) 1
(1 0,0,0) | (2) 2 (0,0,1/2) 0,0,z
(2 _z 0,0,1/2) | (3) 4 ⁺ (0,0,1/4) 0,0,z
(4 _z 0,0,1/4)' | (4) 4 ⁻ (0,0,3/4) 0,0,z
(4 _z ⁻¹ 0,0,3/4)' |
| (5) 2 x,0,0
(2 _y 0,0,0) | (6) 2 0,y,1/4
(2 _x 0,0,1/2) | (7) 2' x,x,1/8
(2 _{xy} 0,0,1/4)' | (8) 2' x, \bar{x} ,3/8
(2 _{\bar{xy}} 0,0,3/4)' |

Generators selected (1); t(0,0,1); (2); (3); (5)

Positions

Multiplicity, Wyckoff letter, Site symmetry	Coordinates		
8 c 1	(1) x, y, z [u,v,w]	(2) $\bar{x}, \bar{y}, z+1/2$ [\bar{u}, \bar{v}, w]	
	(3) $\bar{y}, x, z+1/4$ [v, \bar{u}, \bar{w}]	(4) $y, \bar{x}, z+3/4$ [\bar{v}, u, \bar{w}]	
	(5) x, \bar{y}, \bar{z} [u, \bar{v}, \bar{w}]	(6) $\bar{x}, y, \bar{z}+1/2$ [\bar{u}, v, \bar{w}]	
	(7) $y, x, \bar{z}+1/4$ [\bar{v}, \bar{u}, w]	(8) $\bar{y}, \bar{x}, \bar{z}+3/4$ [v, u, w]	
	4 b ..2'	$x, x, 1/8$ [u, \bar{u} ,w]	$\bar{x}, \bar{x}, 5/8$ [\bar{u}, u, w]
		$\bar{x}, x, 3/8$ [$\bar{u}, \bar{u}, \bar{w}$]	$x, \bar{x}, 7/8$ [u,u, \bar{w}]
	4 a .2.	$x, 0, 0$ [u,0,0]	$\bar{x}, 0, 1/2$ [$\bar{u}, 0, 0$]
		$0, x, 1/4$ [0, \bar{u} ,0]	$0, \bar{x}, 3/4$ [0,u,0]

Symmetry of special projections

Along [001] 4'm'm	Along [100] p2m'g'	Along [110] p2'mg'
Origin at 0,0,z	a* = c Origin at x,0,0	a* = c Origin at x,x,1/8

$p4_222$

422

Tetragonal

No. 32.1.162

$p4_222$

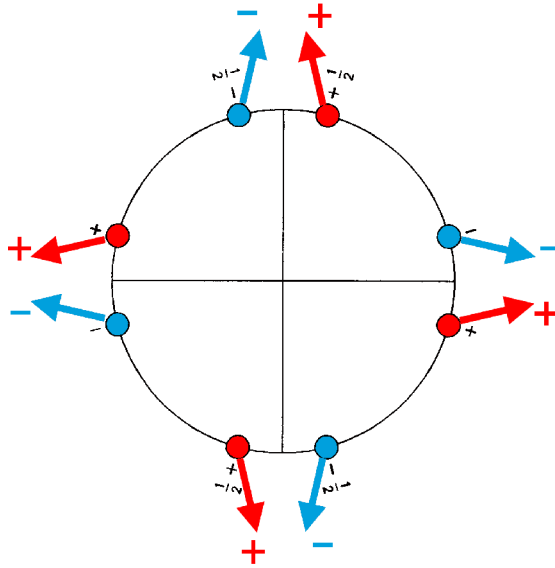
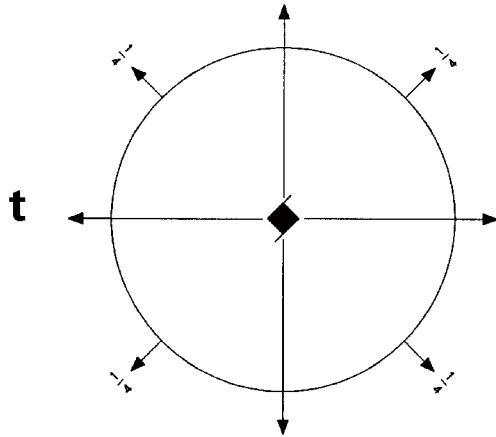

Origin at 222 at 4_221

Asymmetric unit $0 \leq x; 0 \leq z \leq 1/4$

Symmetry operations

- | | | | |
|--|--|---|---|
| (1) 1
(1 0,0,0) | (2) 2 0,0,z
(2 _z 0,0,0) | (3) 4 ⁺ (0,0,1/2) 0,0,z
(4 _z 0,0,1/2) | (4) 4 ⁻ (0,0,1/2) 0,0,z
(4 _z ⁻¹ 0,0,1/2) |
| (5) 2 0,y,0
(2 _y 0,0,0) | (6) 2 x,0,0
(2 _x 0,0,0) | (7) 2 x,x,1/4
(2 _{xy} 0,0,1/2) | (8) 2 x, \bar{x} ,1/4
(2 _{\bar{xy}} 0,0,1/2) |

Generators selected (1); t(0,0,1); (2); (3); (5)

Positions

	Coordinates		
Multiplicity, Wyckoff letter, Site symmetry			
8 h 1	(1) x,y,z [u,v,w]	(2) \bar{x},\bar{y},z [\bar{u},\bar{v},w]	
	(3) $\bar{y},x,z+1/2$ [\bar{v},u,w]	(4) $y,\bar{x},z+1/2$ [v,\bar{u},w]	
	(5) \bar{x},y,\bar{z} [\bar{u},v,\bar{w}]	(6) x,\bar{y},\bar{z} [u,\bar{v},\bar{w}]	
	(7) $y,x,\bar{z}+1/2$ [v,u,\bar{w}]	(8) $\bar{y},\bar{x},\bar{z}+1/2$ [\bar{v},\bar{u},\bar{w}]	
	4 g ..2	x,x,3/4 [u,u,0]	$\bar{x},\bar{x},3/4$ [$\bar{u},\bar{u},0$]
		$\bar{x},x,1/4$ [$\bar{u},u,0$]	$x,\bar{x},1/4$ [$u,\bar{u},0$]
	4 f ..2	x,x,1/4 [u,u,0]	$\bar{x},\bar{x},1/4$ [$\bar{u},\bar{u},0$]
		$\bar{x},x,3/4$ [$\bar{u},u,0$]	$x,\bar{x},3/4$ [$u,\bar{u},0$]
4 e .2.	x,0,1/2 [u,0,0]	$\bar{x},0,1/2$ [$\bar{u},0,0$]	
	0,x,0 [0,u,0]	0, $\bar{x},0$ [0, $\bar{u},0$]	
4 d .2.	x,0,0 [u,0,0]	$\bar{x},0,0$ [$\bar{u},0,0$]	
	0,x,1/2 [0,u,0]	0, $\bar{x},1/2$ [0, $\bar{u},0$]	
4 c 2..	0,0,z [0,0,w]	0,0,z+1/2 [0,0,w]	
	0,0, \bar{z} [0,0, \bar{w}]	0,0, $\bar{z}+1/2$ [0,0, \bar{w}]	
2 b 2.22	0,0,1/4 [0,0,0]	0,0,3/4 [0,0,0]	
2 a 222.	0,0,0 [0,0,0]	0,0,1/2 [0,0,0]	

Symmetry of special projectionsAlong [001] $4m'm'$

Origin at 0,0,z

Along [100] $p2m'm'$ $a^* = c$

Origin at x,0,0

Along [110] $p2m'm'$ $a^* = c$

Origin at x,x,1/4

$p4_2221'$

No. 32.2.163

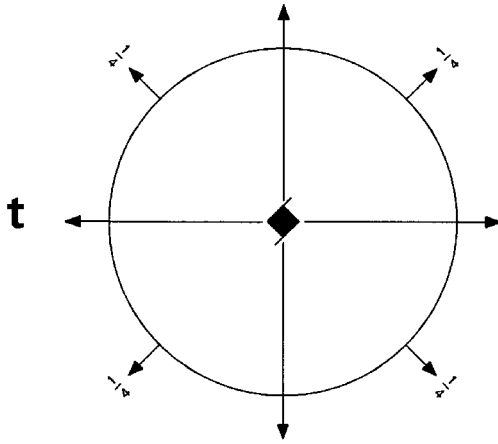

$4221'$

$p4_2221'$

Tetragonal

1'

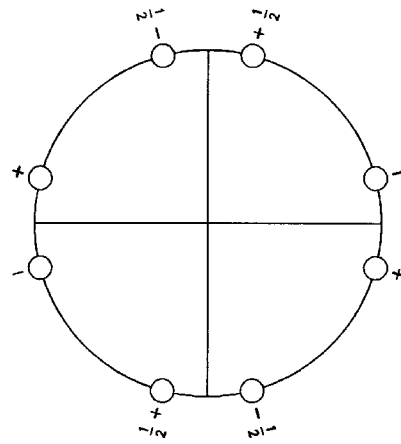

Origin at $2221'$ at $4_2211'$

Asymmetric unit $0 \leq x; 0 \leq z \leq 1/4$

Symmetry operations

For $1 +$ set

(1) 1 (1 0,0,0)	(2) 2 0,0,z (2 _z 0,0,0)	(3) 4 ⁺ (0,0,1/2) 0,0,z (4 _z 0,0,1/2)	(4) 4 ⁻ (0,0,1/2) 0,0,z (4 _z ⁻¹ 0,0,1/2)
--------------------	--	---	---

(5) 2 0,y,0 (2 _y 0,0,0)	(6) 2 x,0,0 (2 _x 0,0,0)	(7) 2 x,x,1/4 (2 _{xy} 0,0,1/2)	(8) 2 x, \bar{x} ,1/4 (2 _{\bar{xy}} 0,0,1/2)
--	--	---	--

For $1' +$ set

(1) 1' (1 0,0,0)'	(2) 2' 0,0,z (2 _z 0,0,0)'	(3) 4 ⁺ ' (0,0,1/2) 0,0,z (4 _z 0,0,1/2)'	(4) 4 ⁻ ' (0,0,1/2) 0,0,z (4 _z ⁻¹ 0,0,1/2)'
----------------------	--	--	--

(5) 2' 0,y,0 (2 _y 0,0,0)'	(6) 2' x,0,0 (2 _x 0,0,0)'	(7) 2' x,x,1/4 (2 _{xy} 0,0,1/2)'	(8) 2' x, \bar{x} ,1/4 (2 _{\bar{xy}} 0,0,1/2)'
--	--	---	--

Generators selected (1); t(0,0,1); (2); (3); (5); 1'

Positions

Multiplicity, Wyckoff letter, Site symmetry	Coordinates	
	1+	1' +
8 h 11'	(1) x,y,z [0,0,0]	(2) \bar{x},\bar{y},z [0,0,0]
	(3) $\bar{y},x,z+1/2$ [0,0,0]	(4) $y,\bar{x},z+1/2$ [0,0,0]
	(5) \bar{x},y,\bar{z} [0,0,0]	(6) x,\bar{y},\bar{z} [0,0,0]
	(7) $y,x,\bar{z}+1/2$ [0,0,0]	(8) $\bar{y},\bar{x},\bar{z}+1/2$ [0,0,0]
4 g ..21'	x,x,3/4 [0,0,0]	$\bar{x},\bar{x},3/4$ [0,0,0]
	$\bar{x},x,1/4$ [0,0,0]	$x,\bar{x},1/4$ [0,0,0]
4 f ..21'	x,x,1/4 [0,0,0]	$\bar{x},\bar{x},1/4$ [0,0,0]
	$\bar{x},x,3/4$ [0,0,0]	$x,\bar{x},3/4$ [0,0,0]
4 e .2.1'	x,0,1/2 [0,0,0]	$\bar{x},0,1/2$ [0,0,0]
	0,x,0 [0,0,0]	0, \bar{x} ,0 [0,0,0]
4 d .2.1'	x,0,0 [0,0,0]	$\bar{x},0,0$ [0,0,0]
	0,x,1/2 [0,0,0]	0, \bar{x} ,1/2 [0,0,0]
4 c 2..1'	0,0,z [0,0,0]	0,0,z+1/2 [0,0,0]
	0,0, \bar{z} [0,0,0]	0,0, $\bar{z}+1/2$ [0,0,0]
2 b 2.221'	0,0,1/4 [0,0,0]	0,0,3/4 [0,0,0]
2 a 222.1'	0,0,0 [0,0,0]	0,0,1/2 [0,0,0]

Symmetry of special projectionsAlong [001] $4mm1'$

Origin at 0,0,z

Along [100] $p2mm1'$ $a^* = c$

Origin at x,0,0

Along [110] $p2mm1'$ $a^* = c$

Origin at x,x,1/4

$p4_22'2'$

No. 32.3.164

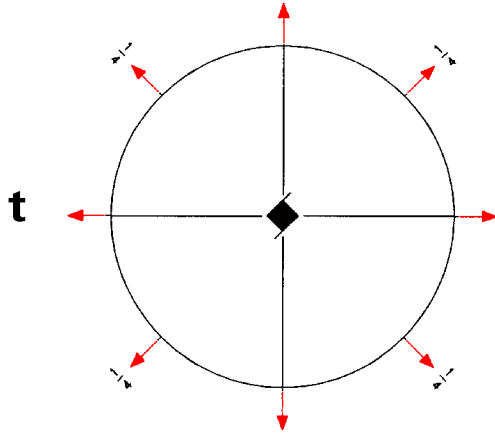

$42'2'$

$p4_22'2'$

Tetragonal

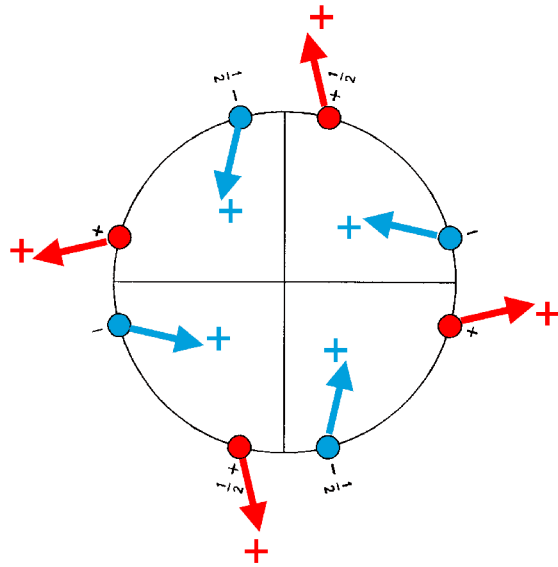

Origin at $2'2'2'$ at $4_22'1$

Asymmetric unit $0 \leq x; 0 \leq z \leq 1/4$

Symmetry operations

- | | | | |
|--------------------------------------|--------------------------------------|--|--|
| (1) 1
(1 0,0,0) | (2) $2_{0,0,z}$
(2_z 0,0,0) | (3) 4^+ (0,0,1/2) 0,0,z
(4_z 0,0,1/2) | (4) 4^- (0,0,1/2) 0,0,z
(4_z^{-1} 0,0,1/2) |
| (5) $2'_y$ 0,y,0
(2_y 0,0,0)' | (6) $2'_x$ x,0,0
(2_x 0,0,0)' | (7) $2'_{xy}$ x,x,1/4
(2_{xy} 0,0,1/2)' | (8) $2'_{\bar{xy}}$ x, \bar{x} ,1/4
($2_{\bar{xy}}$ 0,0,1/2)' |

Generators selected (1); $t(0,0,1)$; (2); (3); (5)

Positions

	Coordinates		
Multiplicity, Wyckoff letter, Site symmetry			
8 h 1	(1) x,y,z [u,v,w]	(2) \bar{x},\bar{y},z [\bar{u},\bar{v},w]	
	(3) $\bar{y},x,z+1/2$ [\bar{v},u,w]	(4) $y,\bar{x},z+1/2$ [v,\bar{u},w]	
	(5) \bar{x},y,\bar{z} [u,\bar{v},w]	(6) x,\bar{y},\bar{z} [\bar{u},v,w]	
	(7) $y,x,\bar{z}+1/2$ [\bar{v},\bar{u},w]	(8) $\bar{y},\bar{x},\bar{z}+1/2$ [v,u,w]	
	4 g ..2'	$x,x,3/4$ [u, \bar{u},w]	$\bar{x},\bar{x},3/4$ [\bar{u},u,w]
		$\bar{x},x,1/4$ [u,u,w]	$x,\bar{x},1/4$ [\bar{u},\bar{u},w]
	4 f ..2'	$x,x,1/4$ [u, \bar{u},w]	$\bar{x},\bar{x},1/4$ [\bar{u},u,w]
		$\bar{x},x,3/4$ [u,u,w]	$x,\bar{x},3/4$ [\bar{u},\bar{u},w]
4 e .2'	$x,0,1/2$ [0,v,w]	$\bar{x},0,1/2$ [0, \bar{v},w]	
	$0,x,0$ [$\bar{v},0,w$]	$0,\bar{x},0$ [$v,0,w$]	
4 d .2'	$x,0,0$ [0,v,w]	$\bar{x},0,0$ [0, \bar{v},w]	
	$0,x,1/2$ [$\bar{v},0,w$]	$0,\bar{x},1/2$ [$v,0,w$]	
4 c 2..	$0,0,z$ [0,0,w]	$0,0,z+1/2$ [0,0,w]	
	$0,0,\bar{z}$ [0,0,w]	$0,0,\bar{z}+1/2$ [0,0,w]	
2 b 2.2'2'	$0,0,1/4$ [0,0,w]	$0,0,3/4$ [0,0,w]	
2 a 2.2'2'	$0,0,0$ [0,0,w]	$0,0,1/2$ [0,0,w]	

Continued

No. 32.3.164

$p4_2 2'2'$

Symmetry of special projections

Along [001] 4mm

Along [100] $p2'mm'$

Along [110] $p2'mm'$

$a^* = c$

$a^* = c$

Origin at 0,0,z

Origin at x,0,0

Origin at x,x,1/4

$p4_2'22'$

No. 32.4.165

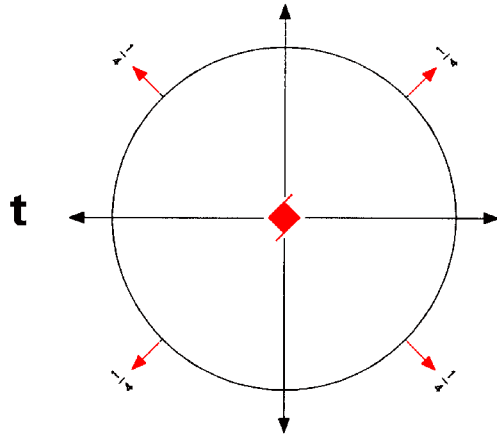

$4'22'$

Tetragonal

$p4_2'22'$

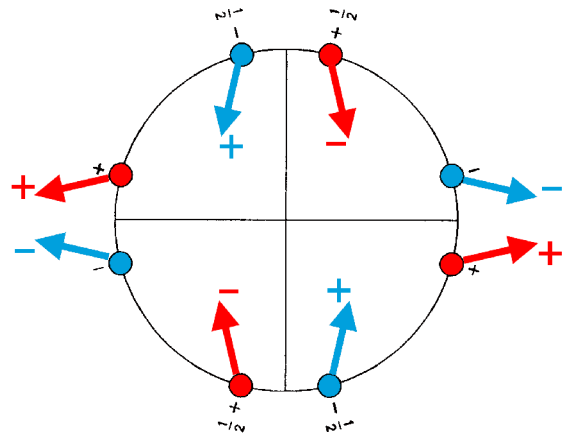

Origin at 222 at $4_2'21$

Asymmetric unit $0 \leq x; 0 \leq z \leq 1/4$

Symmetry operations

- | | | | |
|----------------------------------|----------------------------------|---|--|
| (1) 1
(1 0,0,0) | (2) 2 $0,0,z$
(2_z 0,0,0) | (3) 4^{+} (0,0,1/2) $0,0,z$
(4_z 0,0,1/2)' | (4) 4^{-} (0,0,1/2) $0,0,z$
(4_z^{-1} 0,0,1/2)' |
| (5) 2 $0,y,0$
(2_y 0,0,0) | (6) 2 $x,0,0$
(2_x 0,0,0) | (7) $2'$ $x,x,1/4$
(2_{xy} 0,0,1/2)' | (8) $2'$ $x,\bar{x},1/4$
($2_{\bar{xy}}$ 0,0,1/2)' |

Generators selected (1); $t(0,0,1)$; (2); (3); (5)

Positions

	Coordinates		
Multiplicity, Wyckoff letter, Site symmetry			
8 h 1	(1) x,y,z [u,v,w]	(2) \bar{x},\bar{y},z [\bar{u},\bar{v},w]	
	(3) $\bar{y},x,z+1/2$ [v, \bar{u},\bar{w}]	(4) $y,\bar{x},z+1/2$ [\bar{v},u,\bar{w}]	
	(5) \bar{x},y,\bar{z} [\bar{u},v,\bar{w}]	(6) x,\bar{y},\bar{z} [u, \bar{v},\bar{w}]	
	(7) $y,x,\bar{z}+1/2$ [\bar{v},\bar{u},w]	(8) $\bar{y},\bar{x},\bar{z}+1/2$ [v,u,w]	
	4 g ..2'	$x,x,3/4$ [u, \bar{u},w]	$\bar{x},\bar{x},3/4$ [\bar{u},u,w]
		$\bar{x},x,1/4$ [\bar{u},\bar{u},\bar{w}]	$x,\bar{x},1/4$ [u,u, \bar{w}]
	4 f ..2'	$x,x,1/4$ [u, \bar{u},w]	$\bar{x},\bar{x},1/4$ [\bar{u},u,w]
		$\bar{x},x,3/4$ [\bar{u},\bar{u},\bar{w}]	$x,\bar{x},3/4$ [u,u, \bar{w}]
4 e .2.	$x,0,1/2$ [u,0,0]	$\bar{x},0,1/2$ [$\bar{u},0,0$]	
	$0,x,0$ [0, $\bar{u},0$]	$0,\bar{x},0$ [0,u,0]	
4 d .2.	$x,0,0$ [u,0,0]	$\bar{x},0,0$ [$\bar{u},0,0$]	
	$0,x,1/2$ [0, $\bar{u},0$]	$0,\bar{x},1/2$ [0,u,0]	
4 c 2..	$0,0,z$ [0,0,w]	$0,0,z+1/2$ [0,0, \bar{w}]	
	$0,0,\bar{z}$ [0,0, \bar{w}]	$0,0,\bar{z}+1/2$ [0,0,w]	
2 b 2.2'2'	$0,0,1/4$ [0,0,w]	$0,0,3/4$ [0,0, \bar{w}]	
2 a 222.	$0,0,0$ [0,0,0]	$0,0,1/2$ [0,0,0]	

Continued

No. 32.4.165

$p4_2'22'$

Symmetry of special projections

Along [001] $4'm'm$

Origin at 0,0,z

Along [100] $p2'mm'$

$a^* = c$

Origin at x,0,0

Along [110] $p2'mm'$

$a^* = c$

Origin at x,x,1/4

$p_{2c}4_222$

No. 32.5.166

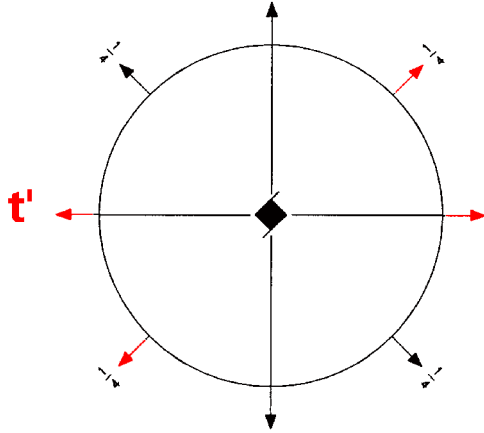

4221'

Tetragonal

$p_{2c}4_222$

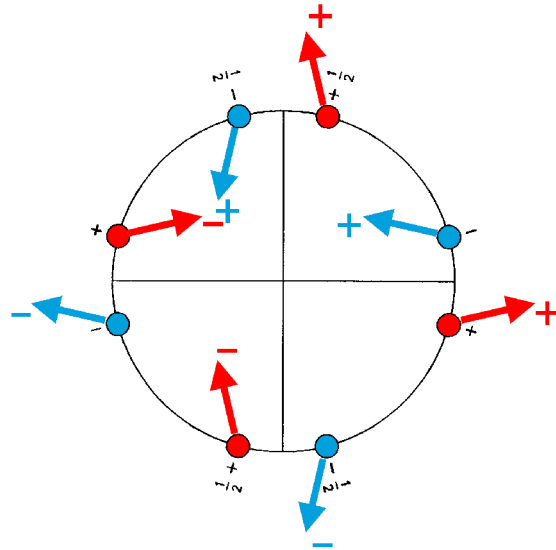

Origin at $22'2'$ at 4_221

Asymmetric unit $0 \leq x$; $0 \leq z \leq 1/4$

Symmetry operations

For $(0,0,0)$ + set

- | | | | |
|------------------------------------|------------------------------------|--|---|
| (1) 1
(1 0,0,0) | (2) $2'$ 0,0,z
(2_z 0,0,0)' | (3) 4^+ (0,0,1/2) 0,0,z
(4_z 0,0,1/2) | (4) 4^- (0,0,1/2) 0,0,z
(4_z^{-1} 0,0,1/2)' |
| (5) $2'$ 0,y,0
(2_y 0,0,0)' | (6) 2 x,0,0
(2_x 0,0,0) | (7) 2 x,x,1/4
(2_{xy} 0,0,1/2) | (8) $2'$ x, \bar{x} ,1/4
($2_{\bar{xy}}$ 0,0,1/2)' |

For $(0,0,1)'$ + set

- | | | | |
|------------------------------------|--|--|---|
| (1) t' (0,0,1)
(1 0,0,1)' | (2) 2 (0,0,1) 0,0,z
(2_z 0,0,1) | (3) $4^{+'}$ (0,0,3/2) 0,0,z
(4_z 0,0,3/2)' | (4) $4^{-'}$ (0,0,3/2) 0,0,z
(4_z^{-1} 0,0,3/2)' |
| (5) 2 0,y,1/2
(2_y 0,0,1) | (6) $2'$ x,0,1/2
(2_x 0,0,1)' | (7) $2'$ x,x,3/4
(2_{xy} 0,0,3/2)' | (8) 2 x, \bar{x} ,3/4
($2_{\bar{xy}}$ 0,0,3/2) |

Generators selected (1); $t(0,0,1)'$; (2); (3); (5)

Positions

Multiplicity, Wyckoff letter, Site symmetry	Coordinates	
	(0,0,0)+	(0,0,1)' +
8 h 1	(1) x,y,z [u,v,w]	(2) \bar{x},\bar{y},z [u,v, \bar{w}]
	(3) $\bar{y},x,z+1/2$ [\bar{v} ,u,w]	(4) $y,\bar{x},z+1/2$ [\bar{v} ,u, \bar{w}]
	(5) \bar{x},y,\bar{z} [u, \bar{v} ,w]	(6) x,\bar{y},\bar{z} [u, \bar{v} , \bar{w}]
	(7) $y,x,\bar{z}+1/2$ [v,u, \bar{w}]	(8) $\bar{y},\bar{x},\bar{z}+1/2$ [v,u,w]
4 g ..2'	$x,x,3/4$ [u, \bar{u} ,w]	$\bar{x},\bar{x},3/4$ [u, \bar{u} , \bar{w}]
	$\bar{x},x,1/4$ [\bar{u} , \bar{u} , \bar{w}]	$x,\bar{x},1/4$ [\bar{u} , \bar{u} ,w]
4 f ..2	$x,x,1/4$ [u,u,0]	$\bar{x},\bar{x},1/4$ [u,u,0]
	$\bar{x},x,3/4$ [\bar{u} ,u,0]	$x,\bar{x},3/4$ [\bar{u} ,u,0]
4 e .2'	$x,0,1/2$ [0,v,w]	$\bar{x},0,1/2$ [0,v, \bar{w}]
	$0,x,0$ [v,0, \bar{w}]	$0,\bar{x},0$ [v,0,w]
4 d .2.	$x,0,0$ [u,0,0]	$\bar{x},0,0$ [u,0,0]
	$0,x,1/2$ [0,u,0]	$0,\bar{x},1/2$ [0,u,0]
4 c 2'..	$0,0,z$ [u,v,0]	$0,0,z+1/2$ [\bar{v} ,u,0]
	$0,0,\bar{z}$ [u, \bar{v} ,0]	$0,0,\bar{z}+1/2$ [v,u,0]
2 b 2'.22'	$0,0,1/4$ [u,u,0]	$0,0,3/4$ [\bar{u} ,u,0]
2 a 2'22'.	$0,0,0$ [u,0,0]	$0,0,1/2$ [0,u,0]

Symmetry of special projectionsAlong [001] $4mm1'$

Origin at 0,0,z

Along [100] $p_{2a^*} 2m'm'$ $a^* = c$

Origin at x,0,0

Along [110] $p_{2a^*} 2m'm'$ $a^* = c$

Origin at x,x,1/4

$p_{2c}4_2'22'$

4221'

Tetragonal

No. 32.6.167

$p_{2c}4_2'22'$

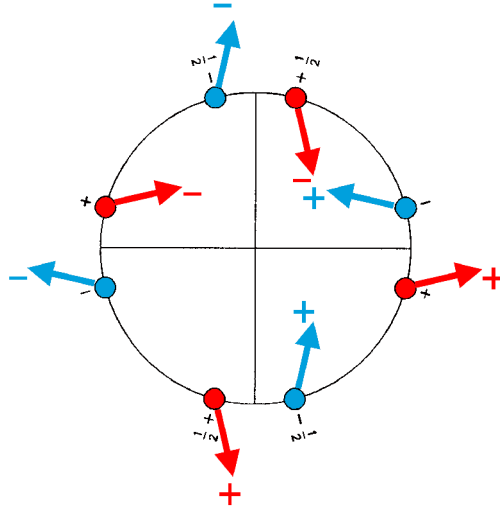
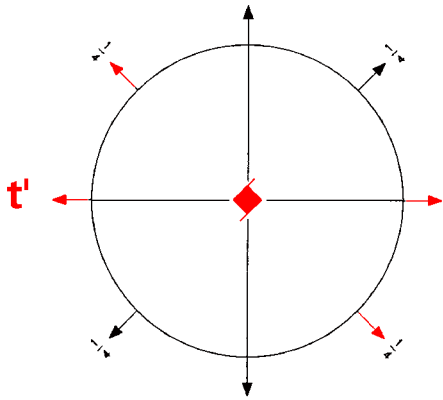

Origin at $22'2'$ at $4_2'21$

Asymmetric unit $0 \leq x; 0 \leq z \leq 1/4$

Symmetry operations

For $(0,0,0)$ + set

(1) 1 (1 0,0,0)	(2) $2'$ 0,0,z (2_z 0,0,0)'	(3) 4^{+} (0,0,1/2) 0,0,z (4_z 0,0,1/2)'	(4) 4^{-} (0,0,1/2) 0,0,z (4_z^{-1} 0,0,1/2)
--------------------	------------------------------------	---	---

(5) $2'$ 0,y,0 (2_y 0,0,0)'	(6) 2 x,0,0 (2_x 0,0,0)	(7) $2'$ x,x,1/4 (2_{xy} 0,0,1/2)'	(8) 2 x, \bar{x} ,1/4 ($2_{\bar{xy}}$ 0,0,1/2)
------------------------------------	----------------------------------	---	---

For $(0,0,1)$ + set

(1) t' (0,0,1) (1 0,0,1)'	(2) 2 (0,0,1) 0,0,z (2_z 0,0,1)	(3) 4^{+} (0,0,3/2) 0,0,z (4_z 0,0,3/2)	(4) 4^{-} (0,0,3/2) 0,0,z (4_z^{-1} 0,0,3/2)'
--------------------------------	--	--	--

(5) 2 0,y,1/2 (2_y 0,0,1)	(6) $2'$ x,0,1/2 (2_x 0,0,1)'	(7) 2 x,x,3/4 (2_{xy} 0,0,3/2)	(8) $2'$ x, \bar{x} ,3/4 ($2_{\bar{xy}}$ 0,0,3/2)'
------------------------------------	--------------------------------------	---	---

Generators selected (1); $t(0,0,1)'$; (2); (3); (5)

Positions

Multiplicity, Wyckoff letter, Site symmetry	Coordinates	
	(0,0,0)+	(0,0,1)' +
8 h 1	(1) x,y,z [u,v,w]	(2) \bar{x},\bar{y},z [u,v, \bar{w}]
	(3) $\bar{y},x,z+1/2$ [v, \bar{u},\bar{w}]	(4) $y,\bar{x},z+1/2$ [v, \bar{u},w]
	(5) \bar{x},y,\bar{z} [u, \bar{v},w]	(6) x,\bar{y},\bar{z} [u, \bar{v},\bar{w}]
	(7) $y,x,\bar{z}+1/2$ [\bar{v},\bar{u},w]	(8) $\bar{y},\bar{x},\bar{z}+1/2$ [\bar{v},\bar{u},\bar{w}]
4 g ..2	$x,x,3/4$ [u, \bar{u},w]	$\bar{x},\bar{x},3/4$ [u, \bar{u},\bar{w}]
	$\bar{x},x,1/4$ [u,u,w]	$x,\bar{x},1/4$ [u,u, \bar{w}]
4 f ..2'	$x,x,1/4$ [u,u,0]	$\bar{x},\bar{x},1/4$ [u,u,0]
	$\bar{x},x,3/4$ [u, $\bar{u},0$]	$x,\bar{x},3/4$ [u, $\bar{u},0$]
4 e .2'	$x,0,1/2$ [0,v,w]	$\bar{x},0,1/2$ [0,v, \bar{w}]
	$0,x,0$ [$\bar{v},0,w$]	$0,\bar{x},0$ [$\bar{v},0,\bar{w}$]
4 d .2.	$x,0,0$ [u,0,0]	$\bar{x},0,0$ [u,0,0]
	$0,x,1/2$ [0, $\bar{u},0$]	$0,\bar{x},1/2$ [0, $\bar{u},0$]
4 c 2'..	$0,0,z$ [u,v,0]	$0,0,z+1/2$ [v, $\bar{u},0$]
	$0,0,\bar{z}$ [u, $\bar{v},0$]	$0,0,\bar{z}+1/2$ [$\bar{v},\bar{u},0$]
2 b 2'.2'2	$0,0,1/4$ [u, $\bar{u},0$]	$0,0,3/4$ [$\bar{u},\bar{u},0$]
2 a 2'22'.	$0,0,0$ [u,0,0]	$0,0,1/2$ [0, $\bar{u},0$]

Continued

No. 32.6.167

$P_{2c} 4_2'22'$

Symmetry of special projections

Along [001] $4mm1'$

Origin at 0,0,z

Along [100] $P_{2a^*} 2m'm'$

$a^* = c$

Origin at x,0,0

Along [110] $P_{2a^*} 2'mm'$

$a^* = c$

Origin at x,x,1/4

$p4_322$

422

Tetragonal

No. 33.1.168

$p4_322$

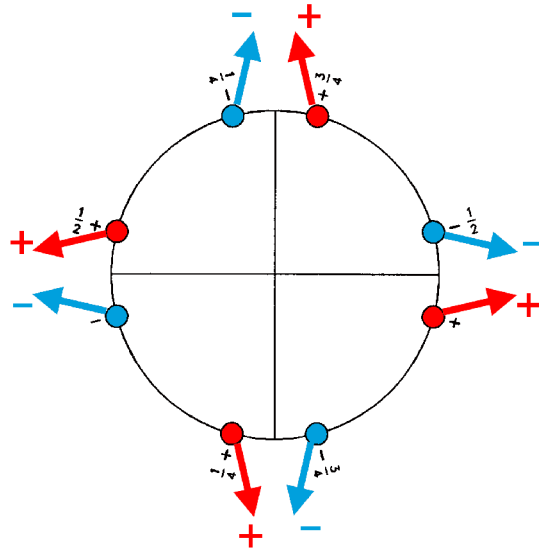
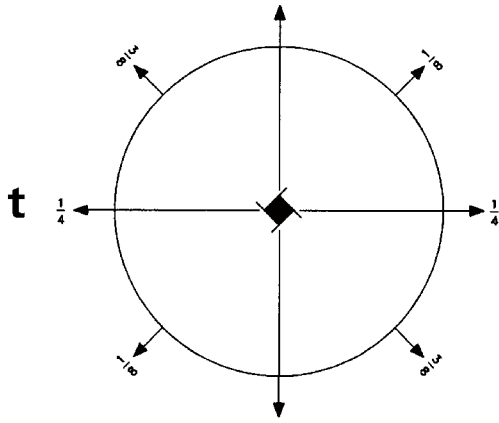

Origin on $2[100]$ at $4_3(2,1)1$

Asymmetric unit $0 \leq z \leq 1/8$

Symmetry operations

- | | | | |
|--|--|---|---|
| (1) 1
(1 0,0,0) | (2) 2 (0,0,1/2) 0,0,z
(2 _z 0,0,1/2) | (3) 4 ⁺ (0,0,3/4) 0,0,z
(4 _z 0,0,3/4) | (4) 4 ⁻ (0,0,1/4) 0,0,z
(4 _z ⁻¹ 0,0,1/4) |
| (5) 2 x,0,0
(2 _x 0,0,0) | (6) 2 0,y,1/4
(2 _y 0,0,1/2) | (7) 2 x,x,3/8
(2 _{xy} 0,0,3/4) | (8) 2 x,x̄,1/8
(2 _{x̄y} 0,0,1/4) |

Generators selected (1); t(0,0,1); (2); (3); (5)

Positions

	Coordinates		
Multiplicity, Wyckoff letter, Site symmetry			
8 c 1	(1) x,y,z [u,v,w]	(2) $\bar{x},\bar{y},z+1/2$ [\bar{u},\bar{v},w]	
	(3) $\bar{y},x,z+3/4$ [\bar{v},u,w]	(4) $y,\bar{x},z+1/4$ [v,\bar{u},w]	
	(5) x,\bar{y},\bar{z} [u,\bar{v},\bar{w}]	(6) $\bar{x},y,\bar{z}+1/2$ [\bar{u},v,\bar{w}]	
	(7) $y,x,\bar{z}+3/4$ [v,u,\bar{w}]	(8) $\bar{y},\bar{x},\bar{z}+1/4$ [\bar{v},\bar{u},\bar{w}]	
	4 b ..2	$x,x,7/8$ [u,u,0]	$\bar{x},\bar{x},3/8$ [$\bar{u},\bar{u},0$]
		$\bar{x},x,5/8$ [$\bar{u},u,0$]	$x,\bar{x},1/8$ [u, $\bar{u},0$]
	4 a .2.	$x,0,0$ [u,0,0]	$\bar{x},0,1/2$ [$\bar{u},0,0$]
$0,x,3/4$ [0,u,0]		$0,\bar{x},1/4$ [0, $\bar{u},0$]	

Symmetry of special projections

Along [001] 4m'm'	Along [100] p2m'g' a* = c	Along [110] p2m'g' a* = c
Origin at 0,0,z	Origin at x,0,0	Origin at x,x,3/8

$p4_3221'$

4221'

Tetragonal

No. 33.2.169

$p4_3221'$

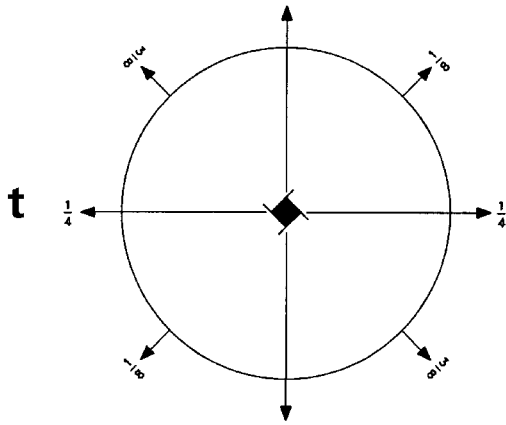

1'

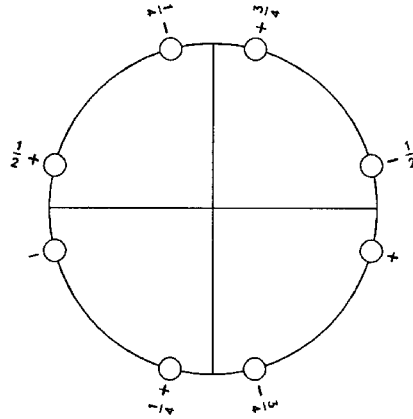

Origin on $21'[100]$ at $4_3(2,1)11'$

Asymmetric unit $0 \leq z \leq 1/8$

Symmetry operations

For 1 + set

(1) 1 (1 0,0,0)	(2) 2 (0,0,1/2) (2 _z 0,0,1/2)	0,0,z	(3) 4 ⁺ (0,0,3/4) (4 _z 0,0,3/4)	0,0,z	(4) 4 ⁻ (0,0,1/4) (4 _z ⁻¹ 0,0,1/4)	0,0,z
--------------------	--	-------	---	-------	---	-------

(5) 2 x,0,0 (2 _x 0,0,0)	(6) 2 0,y,1/4 (2 _y 0,0,1/2)	(7) 2 x,x,3/8 (2 _{xy} 0,0,3/4)	(8) 2 x,x̄,1/8 (2 _{xy} 0,0,1/4)
--	--	---	--

For 1' + set

(1) 1' (1 0,0,0)'	(2) 2' (0,0,1/2) (2 _z 0,0,1/2)'	0,0,z	(3) 4 ⁺ ' (0,0,3/4) (4 _z 0,0,3/4)'	0,0,z	(4) 4 ⁻ ' (0,0,1/4) (4 _z ⁻¹ 0,0,1/4)'	0,0,z
----------------------	--	-------	--	-------	--	-------

(5) 2' x,0,0 (2 _x 0,0,0)'	(6) 2' 0,y,1/4 (2 _y 0,0,1/2)'	(7) 2' x,x,3/8 (2 _{xy} 0,0,3/4)'	(8) 2' x,x̄,1/8 (2 _{xy} 0,0,1/4)'
--	--	---	--

Generators selected (1); t(0,0,1); (2); (3); (5); 1'

Positions

Multiplicity, Wyckoff letter, Site symmetry	Coordinates	
	1+	1' +
8 c 11'	(1) x,y,z [0,0,0]	(2) $\bar{x},\bar{y},z+1/2$ [0,0,0]
	(3) $\bar{y},x,z+3/4$ [0,0,0]	(4) $y,\bar{x},z+1/4$ [0,0,0]
	(5) x,\bar{y},\bar{z} [0,0,0]	(6) $\bar{x},y,\bar{z}+1/2$ [0,0,0]
	(7) $y,x,\bar{z}+3/4$ [0,0,0]	(8) $\bar{y},\bar{x},\bar{z}+1/4$ [0,0,0]
4 b ..21'	x,x,7/8 [0,0,0]	$\bar{x},\bar{x},3/8$ [0,0,0]
	$\bar{x},x,5/8$ [0,0,0]	x, $\bar{x},1/8$ [0,0,0]
4 a .2.1'	x,0,0 [0,0,0]	$\bar{x},0,1/2$ [0,0,0]
	0,x,3/4 [0,0,0]	0, $\bar{x},1/4$ [0,0,0]

Symmetry of special projections

Along [001] 4mm1'	Along [100] p2mg1'	Along [110] p2mg1'
Origin at 0,0,z	a* = c Origin at x,0,0	a* = c Origin at x,x,3/8

$p4_32'2'$

$42'2'$

Tetragonal

No. 33.3.170

$p4_32'2'$

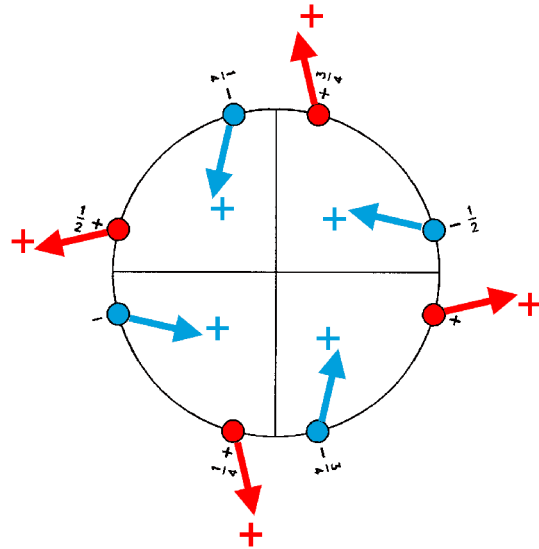
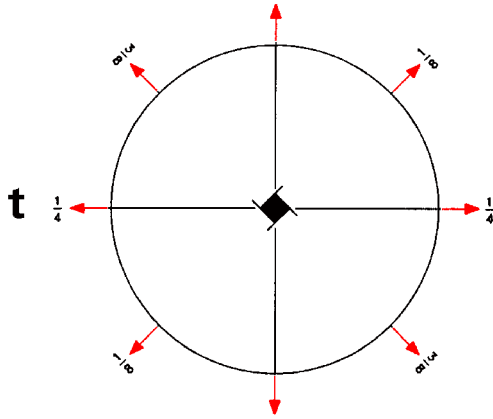

Origin on $2'[100]$ at $4_3(2',1)1$

Asymmetric unit $0 \leq z \leq 1/8$

Symmetry operations

- | | | | |
|--|--|---|---|
| (1) 1
(1 0,0,0) | (2) 2 (0,0,1/2) 0,0,z
(2 _z 0,0,1/2) | (3) 4 ⁺ (0,0,3/4) 0,0,z
(4 _z 0,0,3/4) | (4) 4 ⁻ (0,0,1/4) 0,0,z
(4 _z ⁻¹ 0,0,1/4) |
| (5) 2' x,0,0
(2 _x 0,0,0)' | (6) 2' 0,y,1/4
(2 _y 0,0,1/2)' | (7) 2' x,x,3/8
(2 _{xy} 0,0,3/4)' | (8) 2' x, \bar{x} ,1/8
(2 _{\bar{xy}} 0,0,1/4)' |

Generators selected (1); $t(0,0,1)$; (2); (3); (5)

Positions

	Coordinates		
Multiplicity, Wyckoff letter, Site symmetry			
8 c 1	(1) x, y, z [u,v,w]	(2) $\bar{x}, \bar{y}, z+1/2$ [\bar{u}, \bar{v}, w]	
	(3) $\bar{y}, x, z+3/4$ [\bar{v}, u, w]	(4) $y, \bar{x}, z+1/4$ [v, \bar{u}, w]	
	(5) x, \bar{y}, \bar{z} [\bar{u}, v, w]	(6) $\bar{x}, y, \bar{z}+1/2$ [u, \bar{v}, w]	
	(7) $y, x, \bar{z}+3/4$ [\bar{v}, \bar{u}, w]	(8) $\bar{y}, \bar{x}, \bar{z}+1/4$ [v, u, w]	
	4 b ..2'	$x, x, 7/8$ [u, \bar{u} ,w]	$\bar{x}, \bar{x}, 3/8$ [\bar{u}, u, w]
		$\bar{x}, x, 5/8$ [u,u,w]	$x, \bar{x}, 1/8$ [\bar{u}, \bar{u}, w]
	4 a .2'	$x, 0, 0$ [0,v,w]	$\bar{x}, 0, 1/2$ [0, \bar{v}, w]
		$0, x, 3/4$ [$\bar{v}, 0, w$]	$0, \bar{x}, 1/4$ [$v, 0, w$]

Symmetry of special projections

Along [001] 4mm	Along [100] $p2'mg'$ $a^* = c$	Along [110] $p2'mg'$ $a^* = c$
Origin at 0,0,z	Origin at x,0,0	Origin at x,x,3/8

$p4_3'22'$

$4'22'$

Tetragonal

No. 33.4.171

$p4_3'22'$

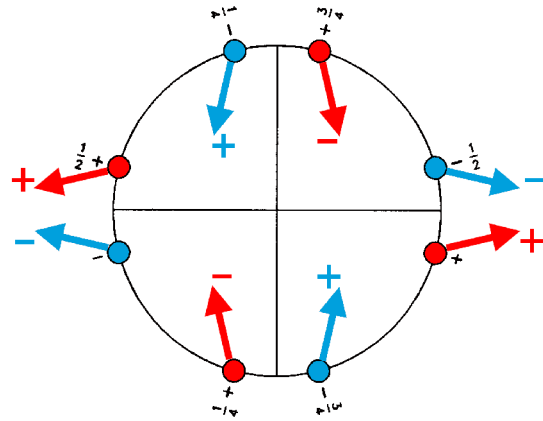
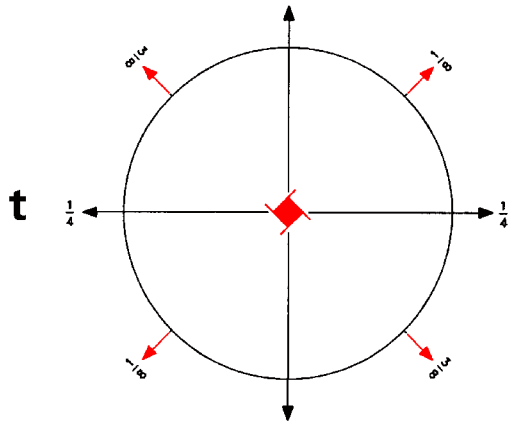

Origin on $2[100]$ at $4_3'(2,1)1$

Asymmetric unit $0 \leq z \leq 1/8$

Symmetry operations

- | | | | |
|--|--|--|--|
| (1) 1
(1 0,0,0) | (2) 2 (0,0,1/2) 0,0,z
(2 _z 0,0,1/2) | (3) 4 ⁺ (0,0,3/4) 0,0,z
(4 _z 0,0,3/4)' | (4) 4 ⁻ (0,0,1/4) 0,0,z
(4 _z ⁻¹ 0,0,1/4)' |
| (5) 2 x,0,0
(2 _x 0,0,0) | (6) 2 0,y,1/4
(2 _y 0,0,1/2) | (7) 2' x,x,3/8
(2 _{xy} 0,0,3/4)' | (8) 2' x,x̄,1/8
(2 _{x̄y} 0,0,1/4)' |

Generators selected (1); $t(0,0,1)$; (2); (3); (5)

Positions

Multiplicity, Wyckoff letter, Site symmetry	Coordinates		
8 c 1	(1) x,y,z [u,v,w]	(2) $\bar{x},\bar{y},z+1/2$ [\bar{u},\bar{v},w]	
	(3) $\bar{y},x,z+3/4$ [\bar{v},\bar{u},\bar{w}]	(4) $y,\bar{x},z+1/4$ [\bar{v},u,\bar{w}]	
	(5) x,\bar{y},\bar{z} [u,\bar{v},\bar{w}]	(6) $\bar{x},y,\bar{z}+1/2$ [\bar{u},v,\bar{w}]	
	(7) $y,x,\bar{z}+3/4$ [\bar{v},\bar{u},w]	(8) $\bar{y},\bar{x},\bar{z}+1/4$ [v,u,w]	
	4 b ..2'	$x,x,7/8$ [u, \bar{u},w]	$\bar{x},\bar{x},3/8$ [\bar{u},u,w]
		$\bar{x},x,5/8$ [\bar{u},\bar{u},\bar{w}]	$x,\bar{x},1/8$ [u, u,\bar{w}]
	4 a .2.	$x,0,0$ [u,0,0]	$\bar{x},0,1/2$ [$\bar{u},0,0$]
		$0,x,3/4$ [0, $\bar{u},0$]	$0,\bar{x},1/4$ [0,u,0]

Symmetry of special projections

Along [001] $4'm'm$ Origin at 0,0,z	Along [100] $p2m'g'$ $a^* = c$ Origin at x,0,0	Along [110] $p2'mg'$ $a^* = c$ Origin at x,x,3/8
--	--	--

$p4mm$

No. 34.1.172

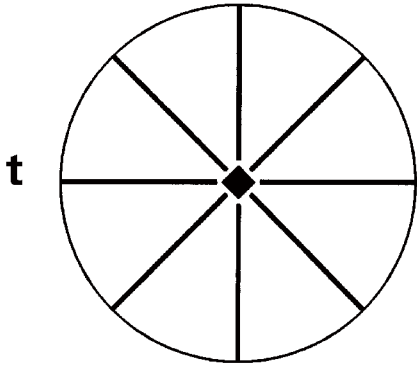

$4mm$

$p4mm$

Tetragonal

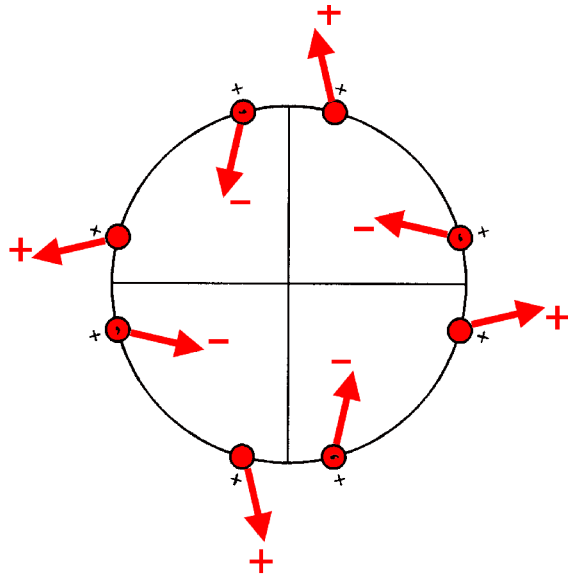

Origin on $4mm$

Asymmetric unit $0 \leq x; 0 \leq y; 0 \leq z \leq 1; x \leq y$

Symmetry operations

- | | | | |
|--------------------------------------|--------------------------------------|---|---|
| (1) 1
(1 0,0,0) | (2) 2 $0,0,z$
(2_z 0,0,0) | (3) 4^+ $0,0,z$
(4_z 0,0,0) | (4) 4^- $0,0,z$
(4_z^{-1} 0,0,0) |
| (5) m_x $x,0,z$
(m_y 0,0,0) | (6) m_y $0,y,z$
(m_x 0,0,0) | (7) m_x x,\bar{x},z
(m_{xy} 0,0,0) | (8) m_x x,x,z
($m_{\bar{xy}}$ 0,0,0) |

Generators selected (1); t(0,0,1); (2); (3); (5)

Positions

Multiplicity, Wyckoff letter, Site symmetry	Coordinates		
8 d 1	(1) x, y, z [u,v,w]	(2) \bar{x}, \bar{y}, z [\bar{u}, \bar{v}, w]	
	(3) \bar{y}, x, z [\bar{v}, u, w]	(4) y, \bar{x}, z [v, \bar{u}, w]	
	(5) x, \bar{y}, z [\bar{u}, v, \bar{w}]	(6) \bar{x}, y, z [u, \bar{v}, \bar{w}]	
	(7) \bar{y}, \bar{x}, z [v,u, \bar{w}]	(8) y, x, z [$\bar{v}, \bar{u}, \bar{w}$]	
	4 c .m.	$x, 0, z$ [0,v,0]	$\bar{x}, 0, z$ [0, $\bar{v}, 0$]
		$0, x, z$ [$\bar{v}, 0, 0$]	$0, \bar{x}, z$ [v,0,0]
	4 b ..m	x, x, z [u, $\bar{u}, 0$]	\bar{x}, \bar{x}, z [$\bar{u}, u, 0$]
		\bar{x}, x, z [u,u,0]	x, \bar{x}, z [$\bar{u}, \bar{u}, 0$]
1 a 4mm	$0, 0, z$ [0,0,0]		

Symmetry of special projections

Along [001] 4mm	Along [100] $p11m1'$ $a^* = c$	Along [110] $p11m1'$ $a^* = c$
Origin at 0,0,z	Origin at x,0,0	Origin at x,x,0

$p4mm1'$

No. 34.2.173

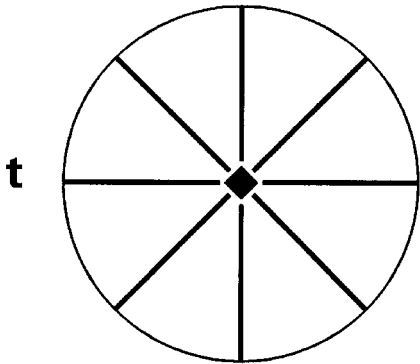

$4mm1'$

$p4mm1'$

Tetragonal

$1'$

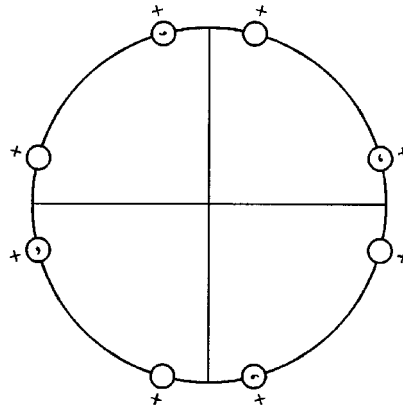

Origin on $4mm1'$

Asymmetric unit $0 \leq x; 0 \leq y; 0 \leq z \leq 1; x \leq y$

Symmetry operations

For $1 +$ set

- | | | | |
|----------------------------------|----------------------------------|---|---|
| (1) 1
$(1 0,0,0)$ | (2) 2 $0,0,z$
$(2_z 0,0,0)$ | (3) 4^+ $0,0,z$
$(4_z 0,0,0)$ | (4) 4^- $0,0,z$
$(4_z^{-1} 0,0,0)$ |
| (5) m $x,0,z$
$(m_y 0,0,0)$ | (6) m $0,y,z$
$(m_x 0,0,0)$ | (7) m x,\bar{x},z
$(m_{xy} 0,0,0)$ | (8) m x,x,z
$(m_{\bar{xy}} 0,0,0)$ |

For $1' +$ set

- | | | | |
|------------------------------------|------------------------------------|---|---|
| (1) $1'$
$(1 0,0,0)'$ | (2) $2'$ $0,0,z$
$(2_z 0,0,0)'$ | (3) $4^{+'}$ $0,0,z$
$(4_z 0,0,0)'$ | (4) $4^{-'}$ $0,0,z$
$(4_z^{-1} 0,0,0)'$ |
| (5) m' $x,0,z$
$(m_y 0,0,0)'$ | (6) m' $0,y,z$
$(m_x 0,0,0)'$ | (7) m' x,\bar{x},z
$(m_{xy} 0,0,0)'$ | (8) m' x,x,z
$(m_{\bar{xy}} 0,0,0)'$ |

Generators selected (1); $t(0,0,1)$; (2); (3); (5); $1'$

Positions

Multiplicity, Wyckoff letter, Site symmetry	Coordinates	
	$1+$	$1'+$
8 d $11'$	(1) $x,y,z [0,0,0]$	(2) $\bar{x},\bar{y},z [0,0,0]$
	(3) $\bar{y},x,z [0,0,0]$	(4) $y,\bar{x},z [0,0,0]$
	(5) $x,\bar{y},z [0,0,0]$	(6) $\bar{x},y,z [0,0,0]$
	(7) $\bar{y},\bar{x},z [0,0,0]$	(8) $y,x,z [0,0,0]$
4 c $.m.1'$	$x,0,z [0,0,0]$	$\bar{x},0,z [0,0,0]$
	$0,x,z [0,0,0]$	$0,\bar{x},z [0,0,0]$
4 b $..m1'$	$x,x,z [0,0,0]$	$\bar{x},\bar{x},z [0,0,0]$
	$\bar{x},x,z [0,0,0]$	$x,\bar{x},z [0,0,0]$
1 a $4mm1'$	$0,0,z [0,0,0]$	

Symmetry of special projections

Along $[001]$ $4mm1'$	Along $[100]$ $p11m1'$	Along $[110]$ $p11m1'$
Origin at $0,0,z$	$a^* = c$ Origin at $x,0,0$	$a^* = c$ Origin at $x,x,0$

$p4m'm'$

No. 34.3.174

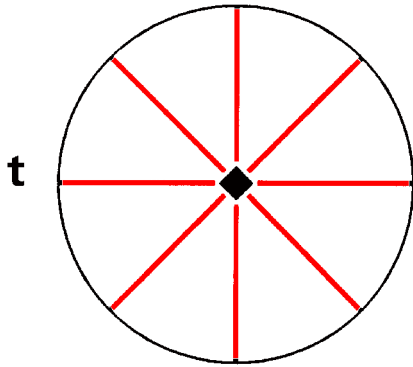

$4m'm'$

$p4m'm'$

Tetragonal

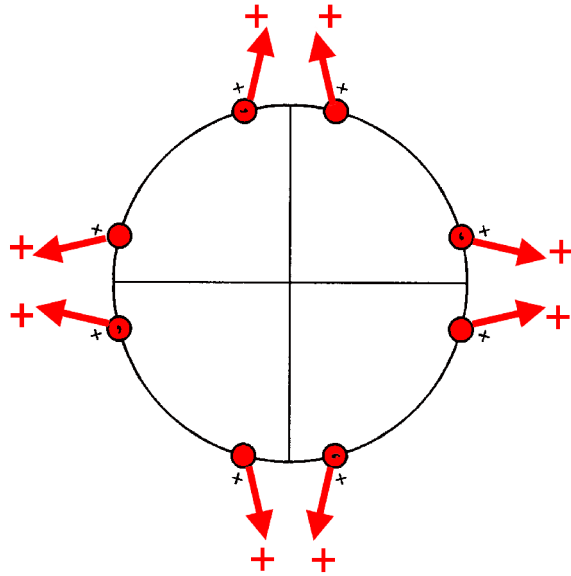

Origin on $4m'm'$

Asymmetric unit $0 \leq x; 0 \leq y; 0 \leq z \leq 1; x \leq y$

Symmetry operations

(1) 1
(1|0,0,0)

(2) $2_{0,0,z}$
(2_z |0,0,0)

(3) 4^+ $0,0,z$
(4_z |0,0,0)

(4) 4^- $0,0,z$
(4_z^{-1} |0,0,0)

(5) m'_x $x,0,z$
(m_y |0,0,0)'

(6) m'_y $0,y,z$
(m_x |0,0,0)'

(7) m'_x x,\bar{x},z
(m_{xy} |0,0,0)'

(8) m'_y x,x,z
($m_{\bar{xy}}$ |0,0,0)'

Generators selected (1); t(0,0,1); (2); (3); (5)

Positions

Multiplicity, Wyckoff letter, Site symmetry	Coordinates		
8 d 1	(1) x,y,z [u,v,w]	(2) \bar{x},\bar{y},z [\bar{u},\bar{v},w]	
	(3) \bar{y},x,z [\bar{v},u,w]	(4) y, \bar{x},z [v, \bar{u},w]	
	(5) x, \bar{y},z [u, \bar{v},w]	(6) \bar{x},y,z [\bar{u},v,w]	
	(7) \bar{y},\bar{x},z [\bar{v},\bar{u},w]	(8) y,x,z [v,u,w]	
	4 c .m'	x,0,z [u,0,w]	$\bar{x},0,z$ [$\bar{u},0,w$]
		0,x,z [0,u,w]	0, \bar{x},z [0, \bar{u},w]
	4 b ..m'	x,x,z [u,u,w]	\bar{x},\bar{x},z [\bar{u},\bar{u},w]
		\bar{x},x,z [\bar{u},u,w]	x, \bar{x},z [u, \bar{u},w]
1 a 4m'm'	0,0,z [0,0,w]		

Symmetry of special projections

Along [001] 4m'm'	Along [100] p11m'	Along [110] p11m'
Origin at 0,0,z	a* = c Origin at x,0,0	a* = c Origin at x,x,0

$p4'mm'$

No. 34.4.175

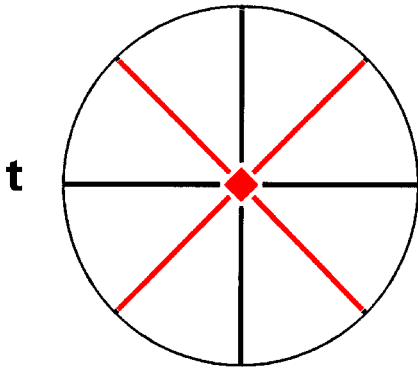

$4'mm'$

$p4'mm'$

Tetragonal

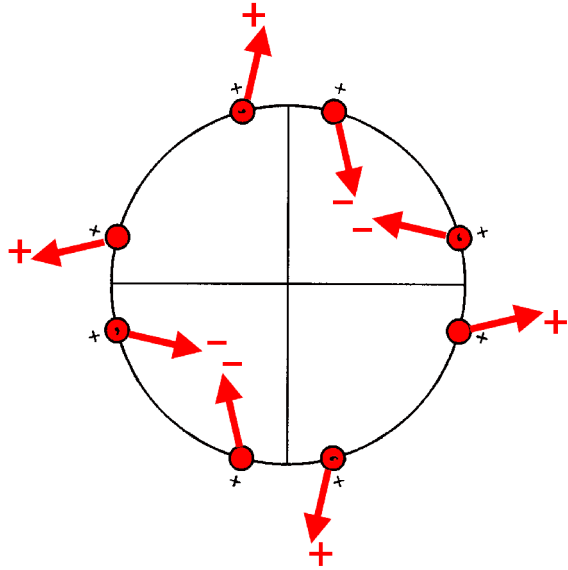

Origin on $4'mm'$

Asymmetric unit $0 \leq x; 0 \leq y; 0 \leq z \leq 1; x \leq y$

Symmetry operations

- | | | | |
|--|--|--|--|
| (1) 1
(1 0,0,0) | (2) 2 0,0,z
(2 _z 0,0,0) | (3) 4 ⁺ 0,0,z
(4 _z 0,0,0)' | (4) 4 ⁻ 0,0,z
(4 _z ⁻¹ 0,0,0)' |
| (5) m x,0,z
(m _y 0,0,0) | (6) m 0,y,z
(m _x 0,0,0) | (7) m' x, \bar{x} ,z
(m _{xy} 0,0,0)' | (8) m' x,x,z
(m _{\bar{xy}} 0,0,0)' |

Generators selected (1); $t(0,0,1)$; (2); (3); (5)

Positions

Multiplicity, Wyckoff letter, Site symmetry	Coordinates	
	(1) x,y,z [u,v,w]	(2) \bar{x},\bar{y},z [\bar{u},\bar{v},w]
8 d 1	(3) \bar{y},x,z [v,\bar{u},\bar{w}]	(4) y,\bar{x},z [\bar{v},u,\bar{w}]
	(5) x,\bar{y},z [\bar{u},v,\bar{w}]	(6) \bar{x},y,z [u,\bar{v},\bar{w}]
	(7) \bar{y},\bar{x},z [\bar{v},\bar{u},w]	(8) y,x,z [v,u,w]
4 c .m.	$x,0,z$ [$0,v,0$]	$\bar{x},0,z$ [$0,\bar{v},0$]
	$0,x,z$ [$v,0,0$]	$0,\bar{x},z$ [$\bar{v},0,0$]
4 b ..m'	x,x,z [u,u,w]	\bar{x},\bar{x},z [\bar{u},\bar{u},w]
	\bar{x},x,z [u,\bar{u},\bar{w}]	x,\bar{x},z [\bar{u},u,\bar{w}]
1 a 4'mm'	$0,0,z$ [$0,0,0$]	

Symmetry of special projections

Along [001] $4'mm'$	Along [100] $p11m1'$	Along [110] $p11m'$
Origin at $0,0,z$	$a^* = c$ Origin at $x,0,0$	$a^* = c$ Origin at $x,x,0$

$p_{2c}4m'm'$

No. 34.5.176

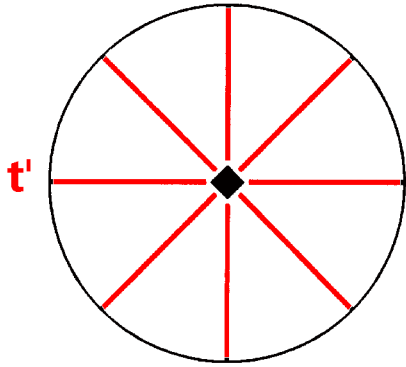

$4mm1'$

$p_{2c}4m'm'$

Tetragonal

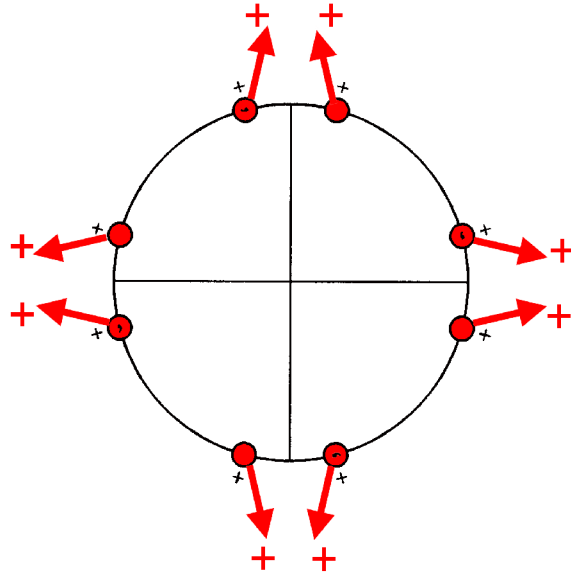

Origin on $4m'm'$

Asymmetric unit $0 \leq x; 0 \leq y; 0 \leq z \leq 1; x \leq y$

Symmetry operations

For $(0,0,0) +$ set

- | | | | |
|--|--|---|---|
| (1) 1
(1 0,0,0) | (2) 2 0,0,z
(2 _z 0,0,0) | (3) 4 ⁺ 0,0,z
(4 _z 0,0,0) | (4) 4 ⁻ 0,0,z
(4 _z ⁻¹ 0,0,0) |
| (5) m' x,0,z
(m _y 0,0,0)' | (6) m' 0,y,z
(m _x 0,0,0)' | (7) m' x,x̄,z
(m _{xy} 0,0,0)' | (8) m' x,x,z
(m _{xy} 0,0,0)' |

For $(0,0,1)'$ + set

- | | | | |
|--|--|--|--|
| (1) t' (0,0,1)
(1 0,0,1)' | (2) 2' (0,0,1) 0,0,z
(2 _z 0,0,1)' | (3) 4 ⁺ ' (0,0,1) 0,0,z
(4 _z 0,0,1)' | (4) 4 ⁻ ' (0,0,1) 0,0,z
(4 _z ⁻¹ 0,0,1)' |
| (5) c (0,0,1) x,0,z
(m _y 0,0,1) | (6) c (0,0,1) 0,y,z
(m _x 0,0,1) | (7) c (0,0,1) x,x̄,z
(m _{xy} 0,0,1) | (8) c (0,0,1) x,x,z
(m _{xy} 0,0,1) |

Generators selected (1); $t(0,0,1)'$; (2); (3); (5)

Positions

Multiplicity, Wyckoff letter, Site symmetry	Coordinates	
	(0,0,0)+	(0,0,1)'+
8 d 1	(1) $x,y,z [u,v,w]$	(2) $\bar{x},\bar{y},z [\bar{u},\bar{v},w]$
	(3) $\bar{y},x,z [\bar{v},u,w]$	(4) $y,\bar{x},z [v,\bar{u},w]$
	(5) $x,\bar{y},z [u,\bar{v},w]$	(6) $\bar{x},y,z [\bar{u},v,w]$
	(7) $\bar{y},\bar{x},z [\bar{v},\bar{u},w]$	(8) $y,x,z [v,u,w]$
4 c .m'	$x,0,z [u,0,w]$	$\bar{x},0,z [\bar{u},0,w]$
	$0,x,z [0,u,w]$	$0,\bar{x},z [0,\bar{u},w]$
4 b ..m'	$x,x,z [u,u,w]$	$\bar{x},\bar{x},z [\bar{u},\bar{u},w]$
	$\bar{x},x,z [\bar{u},u,w]$	$x,\bar{x},z [u,\bar{u},w]$
1 a 4m'm'	$0,0,z [0,0,w]$	

Symmetry of special projections

Along [001] $4mm1'$	Along [100] $p_{2a^*} 11m'$	Along [110] $p_{2a^*} 11m'$
Origin at 0,0,z	$a^* = c$ Origin at $x,0,0$	$a^* = c$ Origin at $x,x,0$

$\rho_{2c}4'm'm$

No. 34.6.177

$4mm1'$

$\rho_{2c}4'm'm$

Tetragonal

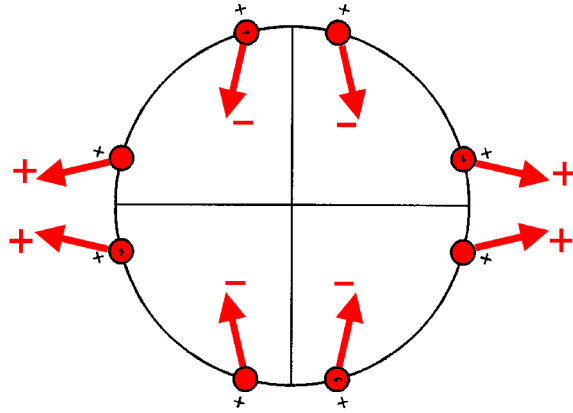
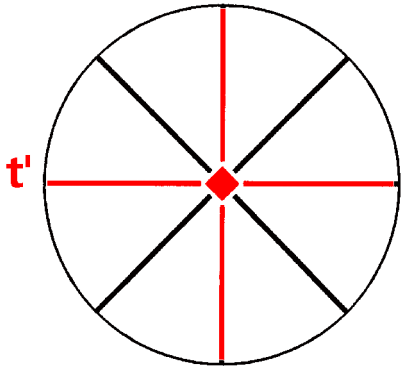

Origin on $4'm'm$

Asymmetric unit $0 \leq x; 0 \leq y; 0 \leq z \leq 1; x \leq y$

Symmetry operations

For $(0,0,0) +$ set

- | | | | |
|--|--|--|--|
| (1) 1
(1 0,0,0) | (2) 2 0,0,z
(2 _z 0,0,0) | (3) 4 ⁺ 0,0,z
(4 _z 0,0,0)' | (4) 4 ⁻ 0,0,z
(4 _z ⁻¹ 0,0,0)' |
| (5) m' x,0,z
(m _y 0,0,0)' | (6) m' 0,y,z
(m _x 0,0,0)' | (7) m x, \bar{x} , z
(m _{xy} 0,0,0) | (8) m x,x,z
(m _{\bar{xy}} 0,0,0) |

For $(0,0,1)'$ + set

- | | | | |
|--|--|--|---|
| (1) t' (0,0,1)
(1 0,0,1)' | (2) 2' (0,0,1) 0,0,z
(2 _z 0,0,1)' | (3) 4 ⁺ (0,0,1) 0,0,z
(4 _z 0,0,1) | (4) 4 ⁻ (0,0,1) 0,0,z
(4 _z ⁻¹ 0,0,1) |
| (5) c (0,0,1) x,0,z
(m _y 0,0,1) | (6) c (0,0,1) 0,y,z
(m _x 0,0,1) | (7) c' (0,0,1) x, \bar{x} , z
(m _{xy} 0,0,1)' | (8) c' (0,0,1) x,x,z
(m _{\bar{xy}} 0,0,1)' |

Generators selected (1); $t(0,0,1)'$; (2); (3); (5)

Positions

Multiplicity, Wyckoff letter, Site symmetry	Coordinates	
	(0,0,0)+	(0,0,1)' +
8 d 1	(1) $x,y,z [u,v,w]$	(2) $\bar{x},\bar{y},z [\bar{u},\bar{v},w]$
	(3) $\bar{y},x,z [v,\bar{u},\bar{w}]$	(4) $y,\bar{x},z [\bar{v},u,\bar{w}]$
	(5) $x,\bar{y},z [u,\bar{v},w]$	(6) $\bar{x},y,z [\bar{u},v,w]$
	(7) $\bar{y},\bar{x},z [v,u,\bar{w}]$	(8) $y,x,z [\bar{v},\bar{u},\bar{w}]$
4 c .m'	$x,0,z [u,0,w]$	$\bar{x},0,z [\bar{u},0,w]$
	$0,x,z [0,\bar{u},\bar{w}]$	$0,\bar{x},z [0,u,\bar{w}]$
4 b ..m	$x,x,z [u,\bar{u},0]$	$\bar{x},\bar{x},z [\bar{u},u,0]$
	$\bar{x},x,z [\bar{u},\bar{u},0]$	$x,\bar{x},z [u,u,0]$
1 a 4'm'm	$0,0,z [0,0,0]$	

Symmetry of special projections

Along [001] $4mm1'$	Along [100] $p_{2a^*} 11m'$	Along [110] $p11m1'$
Origin at 0,0,z	$a^* = c$ Origin at $x,0,0$	$a^* = c$ Origin at $x,x,0$

$p_{2c}4mm$

No. 34.7.178

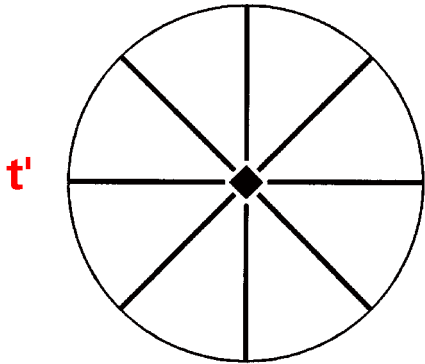

$4mm1'$

$p_{2c}4mm$

Tetragonal

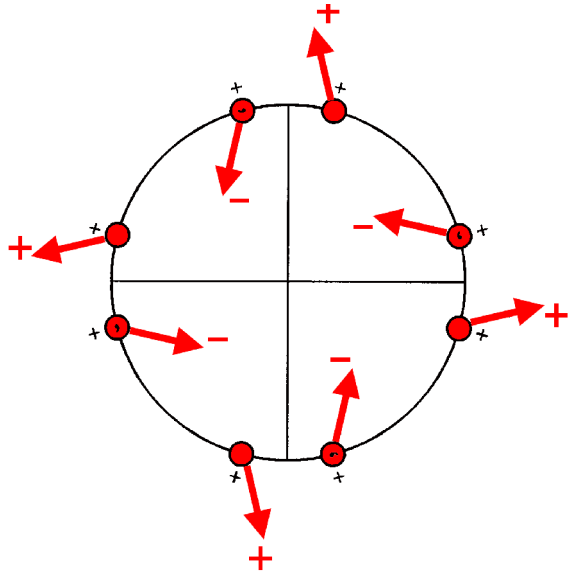

Origin on 4mm

Asymmetric unit $0 \leq x; 0 \leq y; 0 \leq z \leq 1; x \leq y$

Symmetry operations

For (0,0,0) + set

- | | | | |
|--|--|---|---|
| (1) 1
(1 0,0,0) | (2) 2 0,0,z
(2 _z 0,0,0) | (3) 4 ⁺ 0,0,z
(4 _z 0,0,0) | (4) 4 ⁻ 0,0,z
(4 _z ⁻¹ 0,0,0) |
| (5) m x,0,z
(m _y 0,0,0) | (6) m 0,y,z
(m _x 0,0,0) | (7) m x,x̄,z
(m _{xy} 0,0,0) | (8) m x,x,z
(m _{xy} 0,0,0) |

For (0,0,1)' + set

- | | | | |
|--|--|--|--|
| (1) t' (0,0,1)
(1 0,0,1)' | (2) 2' (0,0,1) 0,0,z
(2 _z 0,0,1)' | (3) 4 ⁺ ' (0,0,1) 0,0,z
(4 _z 0,0,1)' | (4) 4 ⁻ ' (0,0,1) 0,0,z
(4 _z ⁻¹ 0,0,1)' |
| (5) c' (0,0,1) x,0,z
(m _y 0,0,1)' | (6) c' (0,0,1) 0,y,z
(m _x 0,0,1)' | (7) c' (0,0,1) x,x̄,z
(m _{xy} 0,0,1)' | (8) c' (0,0,1) x,x,z
(m _{xy} 0,0,1)' |

Generators selected (1); $t(0,0,1)'$; (2); (3); (5)

Positions

Multiplicity, Wyckoff letter, Site symmetry	Coordinates	
	(0,0,0)+	(0,0,1)' +
8 d 1	(1) x,y,z [u,v,w] (3) \bar{y},x,z [\bar{v},u,w] (5) x,\bar{y},z [\bar{u},v,\bar{w}] (7) \bar{y},\bar{x},z [v,u,\bar{w}]	(2) \bar{x},\bar{y},z [\bar{u},\bar{v},w] (4) y,\bar{x},z [v,\bar{u},w] (6) \bar{x},y,z [u,\bar{v},\bar{w}] (8) y,x,z [\bar{v},\bar{u},\bar{w}]
4 c .m.	$x,0,z$ [$0,v,0$] $0,x,z$ [$\bar{v},0,0$]	$\bar{x},0,z$ [$0,\bar{v},0$] $0,\bar{x},z$ [$v,0,0$]
4 b ..m	x,x,z [$u,\bar{u},0$] \bar{x},x,z [$u,u,0$]	\bar{x},\bar{x},z [$\bar{u},u,0$] x,\bar{x},z [$\bar{u},\bar{u},0$]
1 a 4mm	$0,0,z$ [$0,0,0$]	

Symmetry of special projections

Along [001] 4mm1'	Along [100] $p11m1'$ $a^* = c$	Along [110] $p11m1'$ $a^* = c$
Origin at 0,0,z	Origin at $x,0,0$	Origin at $x,x,0$

$p4_2cm$

4mm

Tetragonal

No. 35.1.179

$p4_2cm$

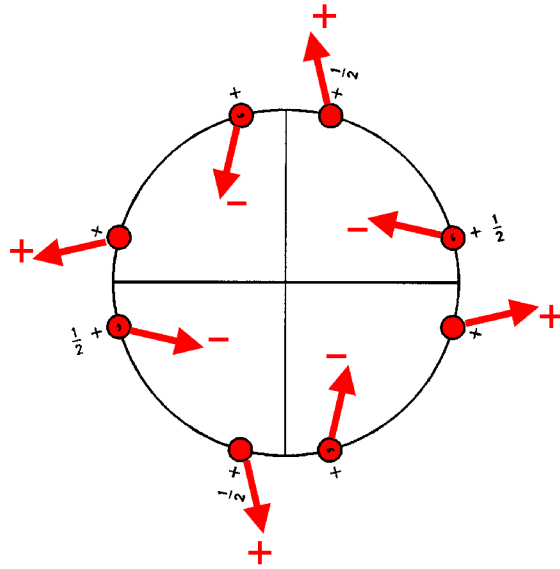
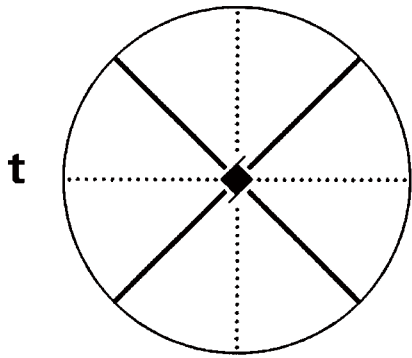

Origin on $2mm$ on 4_2cm

Asymmetric unit $0 \leq x$; $0 \leq y$; $0 \leq z \leq 1$; $x \leq y$

Symmetry operations

- | | | | |
|--|--|--|---|
| (1) 1
(1 0,0,0) | (2) 2 $0,0,z$
(2_z 0,0,0) | (3) 4^+ (0,0,1/2) $0,0,z$
(4_z 0,0,1/2) | (4) 4^- (0,0,1/2) $0,0,z$
(4_z^{-1} 0,0,1/2) |
| (5) c (0,0,1/2) $x,0,z$
(m_y 0,0,1/2) | (6) c (0,0,1/2) $0,y,z$
(m_x 0,0,1/2) | (7) m x,\bar{x},z
(m_{xy} 0,0,0) | (8) m x,x,z
($m_{\bar{xy}}$ 0,0,0) |

Generators selected (1); $t(0,0,1)$; (2); (3); (5)

Positions

	Coordinates		
Multiplicity, Wyckoff letter, Site symmetry			
8 c 1	(1) x,y,z [u,v,w]	(2) \bar{x},\bar{y},z [\bar{u},\bar{v},w]	
	(3) $\bar{y},x,z+1/2$ [\bar{v},u,w]	(4) $y,\bar{x},z+1/2$ [v,\bar{u},w]	
	(5) $x,\bar{y},z+1/2$ [\bar{u},v,\bar{w}]	(6) $\bar{x},y,z+1/2$ [u,\bar{v},\bar{w}]	
	(7) \bar{y},\bar{x},z [v,u,\bar{w}]	(8) y,x,z [\bar{v},\bar{u},\bar{w}]	
	4 b ..m	x,x,z [u, \bar{u} ,0]	\bar{x},\bar{x},z [$\bar{u},u,0$]
		$\bar{x},x,z+1/2$ [u,u,0]	$x,\bar{x},z+1/2$ [$\bar{u},\bar{u},0$]
	1 a 2.mm	$0,0,z$ [0,0,0]	$0,0,z+1/2$ [0,0,0]

Symmetry of special projections

Along [001] 4mm	Along [100] $p_{2a^*} 11m'$ $a^* = c/2$	Along [110] $p11m'$ $a^* = c$
Origin at 0,0,z	Origin at x,0,0	Origin at x,x,0

$p4_2cm1'$

$4mm1'$

Tetragonal

No. 35.2.180

$p4_2cm1'$

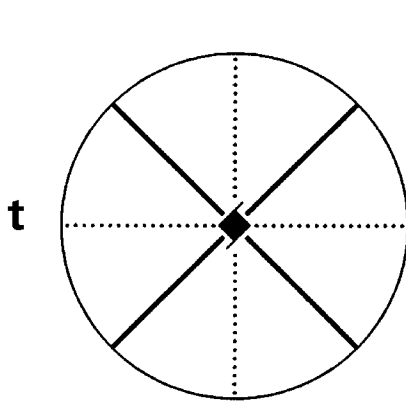

1'

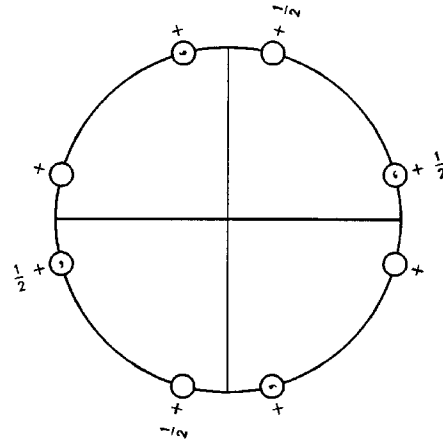

Origin on $2mm1'$ on $4_2cm1'$

Asymmetric unit $0 \leq x$; $0 \leq y$; $0 \leq z \leq 1$; $x \leq y$

Symmetry operations

For $1 +$ set

(1) 1 (1 0,0,0)	(2) 2 0,0,z (2 _z 0,0,0)	(3) 4 ⁺ (0,0,1/2) 0,0,z (4 _z 0,0,1/2)	(4) 4 ⁻ (0,0,1/2) 0,0,z (4 _z ⁻¹ 0,0,1/2)
--------------------	--	---	---

(5) c (0,0,1/2) x,0,z (m _y 0,0,1/2)	(6) c (0,0,1/2) 0,y,z (m _x 0,0,1/2)	(7) m x, \bar{x} , z (m _{xy} 0,0,0)	(8) m x,x,z (m _{\bar{xy}} 0,0,0)
--	--	--	--

For $1' +$ set

(1) 1' (1 0,0,0)'	(2) 2' 0,0,z (2 _z 0,0,0)'	(3) 4 ⁺ ' (0,0,1/2) 0,0,z (4 _z 0,0,1/2)'	(4) 4 ⁻ ' (0,0,1/2) 0,0,z (4 _z ⁻¹ 0,0,1/2)'
----------------------	--	--	--

(5) c' (0,0,1/2) x,0,z (m _y 0,0,1/2)'	(6) c' (0,0,1/2) 0,y,z (m _x 0,0,1/2)'	(7) m' x, \bar{x} , z (m _{xy} 0,0,0)'	(8) m' x,x,z (m _{\bar{xy}} 0,0,0)'
--	--	--	--

Generators selected (1); $t(0,0,1)$; (2); (3); (5); $1'$

Positions

Multiplicity, Wyckoff letter, Site symmetry	Coordinates	
	$1+$	$1' +$
8 c $11'$	(1) $x,y,z [0,0,0]$	(2) $\bar{x},\bar{y},z [0,0,0]$
	(3) $\bar{y},x,z+1/2 [0,0,0]$	(4) $y,\bar{x},z+1/2 [0,0,0]$
	(5) $x,\bar{y},z+1/2 [0,0,0]$	(6) $\bar{x},y,z+1/2 [0,0,0]$
	(7) $\bar{y},\bar{x},z [0,0,0]$	(8) $y,x,z [0,0,0]$
4 b $..m1'$	$x,x,z [0,0,0]$	$\bar{x},\bar{x},z [0,0,0]$
	$\bar{x},x,z+1/2 [0,0,0]$	$x,\bar{x},z+1/2 [0,0,0]$
1 a $2.mm1'$	$0,0,z [0,0,0]$	$0,0,z+1/2 [0,0,0]$

Symmetry of special projections

Along [001] $4mm1'$	Along [100] $p11m1'$	Along [110] $p11m1'$
Origin at $0,0,z$	$a^* = c/2$ Origin at $x,0,0$	$a^* = c$ Origin at $x,x,0$

$p4_2c'm'$

$4m'm'$

Tetragonal

No. 35.3.181

$p4_2c'm'$

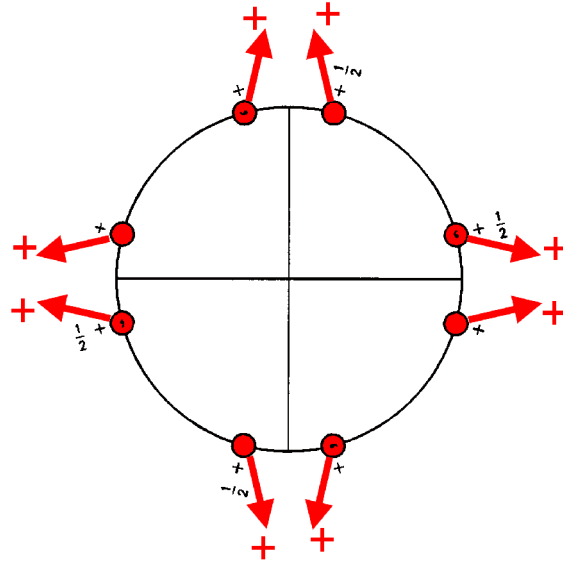
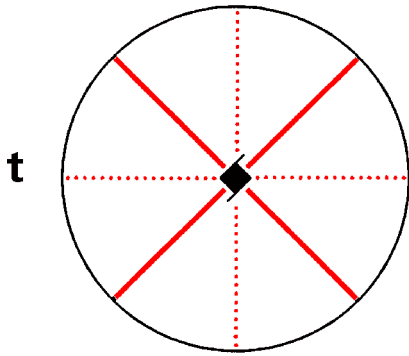

Origin on $2m'm'$ on $4_2c'm'$

Asymmetric unit $0 \leq x$; $0 \leq y$; $0 \leq z \leq 1$; $x \leq y$

Symmetry operations

- | | | | |
|--|--|---|---|
| (1) 1
(1 0,0,0) | (2) 2 $0,0,z$
(2 _z 0,0,0) | (3) 4 ⁺ (0,0,1/2) $0,0,z$
(4 _z 0,0,1/2) | (4) 4 ⁻ (0,0,1/2) $0,0,z$
(4 _z ⁻¹ 0,0,1/2) |
| (5) c' (0,0,1/2) $x,0,z$
(m _y 0,0,1/2)' | (6) c' (0,0,1/2) $0,y,z$
(m _x 0,0,1/2)' | (7) m' x,\bar{x},z
(m _{xy} 0,0,0)' | (8) m' x,x,z
(m _{xy} 0,0,0)' |

Generators selected (1); $t(0,0,1)$; (2); (3); (5)

Positions

Multiplicity, Wyckoff letter, Site symmetry	Coordinates		
8 c 1	(1) x,y,z [u,v,w]	(2) \bar{x},\bar{y},z [\bar{u},\bar{v},w]	
	(3) $\bar{y},x,z+1/2$ [\bar{v},u,w]	(4) $y,\bar{x},z+1/2$ [v,\bar{u},w]	
	(5) $x,\bar{y},z+1/2$ [u,\bar{v},w]	(6) $\bar{x},y,z+1/2$ [\bar{u},v,w]	
	(7) \bar{y},\bar{x},z [\bar{v},\bar{u},w]	(8) y,x,z [v,u,w]	
	4 b ..m'	x,x,z [u,u,w]	\bar{x},\bar{x},z [\bar{u},\bar{u},w]
		$\bar{x},x,z+1/2$ [\bar{u},u,w]	$x,\bar{x},z+1/2$ [u,\bar{u},w]
	1 a 2.m'm'	$0,0,z$ [0,0,w]	$0,0,z+1/2$ [0,0,w]

Symmetry of special projections

Along [001] $4m'm'$	Along [100] $p11m'$	Along [110] $p11m'$
Origin at 0,0,z	$a^* = c/2$ Origin at x,0,0	$a^* = c$ Origin at x,x,0

$p4_2'cm'$

No. 35.4.182

$4'mm'$

$p4_2'cm'$

Tetragonal

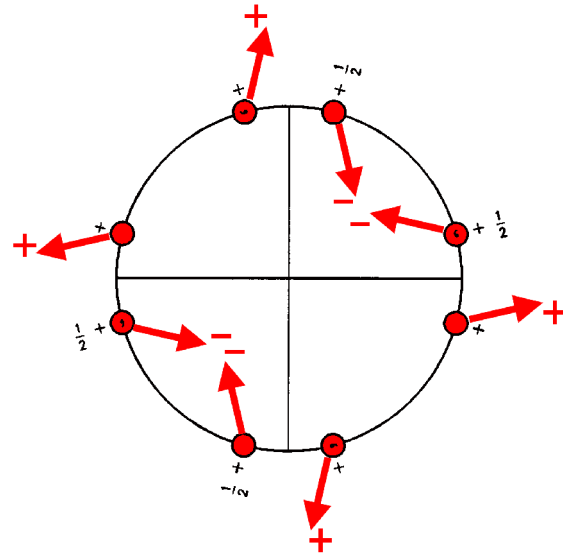
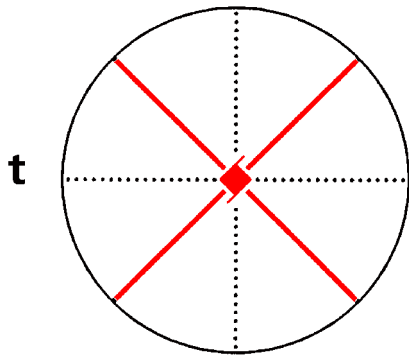

Origin on $2m'm'$ on $4_2'cm'$

Asymmetric unit $0 \leq x; 0 \leq y; 0 \leq z \leq 1; x \leq y$

Symmetry operations

- | | | | |
|--|--|--|--|
| (1) 1
(1 0,0,0) | (2) 2 $0,0,z$
(2 _z 0,0,0) | (3) 4 ⁺ (0,0,1/2) $0,0,z$
(4 _z 0,0,1/2)' | (4) 4 ⁻ (0,0,1/2) $0,0,z$
(4 _z ⁻¹ 0,0,1/2)' |
| (5) c (0,0,1/2) $x,0,z$
(m _y 0,0,1/2) | (6) c (0,0,1/2) $0,y,z$
(m _x 0,0,1/2) | (7) m' x,\bar{x},z
(m _{xy} 0,0,0)' | (8) m' x,x,z
(m _{xy} 0,0,0)' |

Generators selected (1); $t(0,0,1)$; (2); (3); (5)

Positions

Multiplicity, Wyckoff letter, Site symmetry	Coordinates		
8 c 1	(1) x,y,z [u,v,w]	(2) \bar{x},\bar{y},z [\bar{u},\bar{v},w]	
	(3) $\bar{y},x,z+1/2$ [v, \bar{u},\bar{w}]	(4) $y,\bar{x},z+1/2$ [\bar{v},u,\bar{w}]	
	(5) $x,\bar{y},z+1/2$ [\bar{u},v,\bar{w}]	(6) $\bar{x},y,z+1/2$ [u, \bar{v},\bar{w}]	
	(7) \bar{y},\bar{x},z [\bar{v},\bar{u},w]	(8) y,x,z [v,u,w]	
	4 b ..m'	x,x,z [u,u,w]	\bar{x},\bar{x},z [\bar{u},\bar{u},w]
		$\bar{x},x,z+1/2$ [u, \bar{u},\bar{w}]	$x,\bar{x},z+1/2$ [\bar{u},u,\bar{w}]
	1 a 2.m'm'	$0,0,z$ [0,0,w]	$0,0,z+1/2$ [0,0, \bar{w}]

Symmetry of special projections

Along [001] $4'mm'$	Along [100] $p_{2a^*}11m'$	Along [110] $p11m'$
Origin at 0,0,z	$a^* = c/2$ Origin at x,0,0	$a^* = c$ Origin at x,x,0

$p4_2'c'm$

No. 35.5.183

$4'm'm$

$p4_2'c'm$

Tetragonal

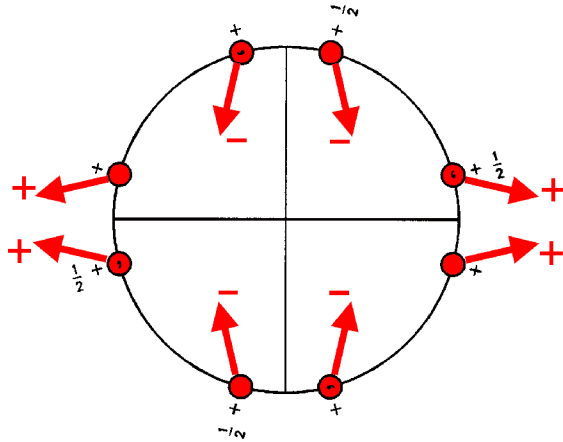
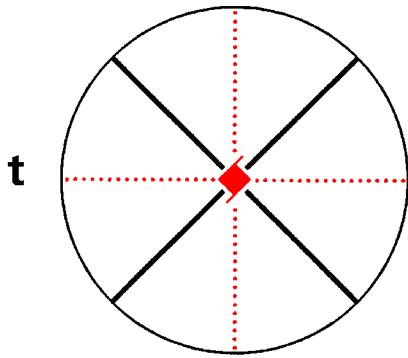

Origin on $2mm$ on $4_2'c'm$

Asymmetric unit $0 \leq x; 0 \leq y; 0 \leq z \leq 1; x \leq y$

Symmetry operations

- | | | | |
|--|--|--|--|
| (1) 1
(1 0,0,0) | (2) 2 0,0,z
(2 _z 0,0,0) | (3) 4 ⁺ (0,0,1/2) 0,0,z
(4 _z 0,0,1/2)' | (4) 4 ⁻ (0,0,1/2) 0,0,z
(4 _z ⁻¹ 0,0,1/2)' |
| (5) c' (0,0,1/2) x,0,z
(m _y 0,0,1/2)' | (6) c' (0,0,1/2) 0,y,z
(m _x 0,0,1/2)' | (7) m x,x̄,z
(m _{xy} 0,0,0) | (8) m x,x,z
(m _{xy} 0,0,0) |

Generators selected (1); $t(0,0,1)$; (2); (3); (5)

Positions

	Coordinates		
Multiplicity, Wyckoff letter, Site symmetry			
8 c 1	(1) x,y,z [u,v,w]	(2) \bar{x},\bar{y},z [\bar{u},\bar{v},w]	
	(3) $\bar{y},x,z+1/2$ [v, \bar{u},\bar{w}]	(4) $y,\bar{x},z+1/2$ [\bar{v},u,\bar{w}]	
	(5) $x,\bar{y},z+1/2$ [u, \bar{v},w]	(6) $\bar{x},y,z+1/2$ [\bar{u},v,w]	
	(7) \bar{y},\bar{x},z [v,u, \bar{w}]	(8) y,x,z [\bar{v},\bar{u},\bar{w}]	
	4 b ..m	x,x,z [u, $\bar{u},0$]	\bar{x},\bar{x},z [$\bar{u},u,0$]
		$\bar{x},x,z+1/2$ [$\bar{u},\bar{u},0$]	$x,\bar{x},z+1/2$ [u,u,0]
	1 a 2.mm	$0,0,z$ [0,0,0]	$0,0,z+1/2$ [0,0,0]

Symmetry of special projections

Along [001] $4'm'm$	Along [100] $p11m'$	Along [110] $p11m1'$
Origin at 0,0,z	$a^* = c/2$ Origin at x,0,0	$a^* = c$ Origin at x,x,0

$p4cc$

$4mm$

Tetragonal

No. 36.1.184

$p4cc$

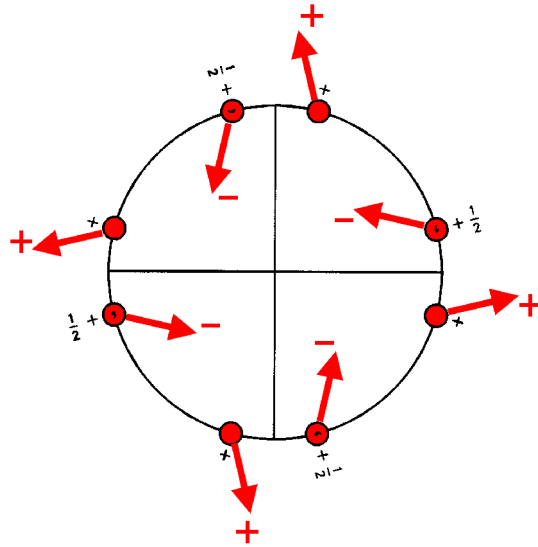
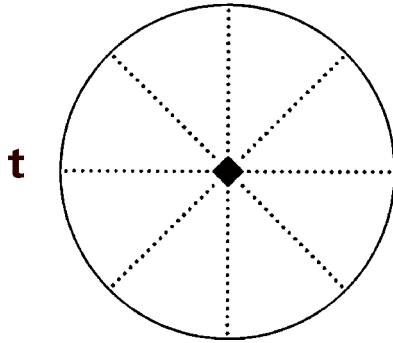

Origin on $4cc$

Asymmetric unit $0 \leq x; 0 \leq y; 0 \leq z \leq 1/2$

Symmetry operations

(1) 1
(1|0,0,0)

(2) $2_{0,0,z}$
(2_z |0,0,0)

(3) 4^+ $0,0,z$
(4_z |0,0,0)

(4) 4^- $0,0,z$
(4_z^{-1} |0,0,0)

(5) $c(0,0,1/2)$ $x,0,z$
(m_y |0,0,1/2)

(6) $c(0,0,1/2)$ $0,y,z$
(m_x |0,0,1/2)

(7) $c(0,0,1/2)$ x,\bar{x},z
(m_{xy} |0,0,1/2)

(8) $c(0,0,1/2)$ x,x,z
($m_{\bar{xy}}$ |0,0,1/2)

Generators selected (1); t(0,0,1); (2); (3); (5)

Positions

Multiplicity, Wyckoff letter, Site symmetry	Coordinates	
	(1) x, y, z [u, v, w]	(2) \bar{x}, \bar{y}, z [\bar{u}, \bar{v}, w]
8 b 1	(3) \bar{y}, x, z [\bar{v}, u, w]	(4) y, \bar{x}, z [v, \bar{u}, w]
	(5) $x, \bar{y}, z + 1/2$ [\bar{u}, v, \bar{w}]	(6) $\bar{x}, y, z + 1/2$ [u, \bar{v}, \bar{w}]
	(7) $\bar{y}, \bar{x}, z + 1/2$ [v, u, \bar{w}]	(8) $y, x, z + 1/2$ [$\bar{v}, \bar{u}, \bar{w}$]
	1 a 4..	
	0,0,z [0,0,w]	0,0,z + 1/2 [0,0, \bar{w}]

Symmetry of special projections

Along [001] 4mm	Along [100] p_{2a^*} 11m'	Along [110] p_{2a^*} 11m'
Origin at 0,0,z	$a^* = c/2$ Origin at x,0,0	$a^* = c/2$ Origin at x,x,0

$p4cc1'$

$4mm1'$

Tetragonal

No. 36.2.185

$p4cc1'$

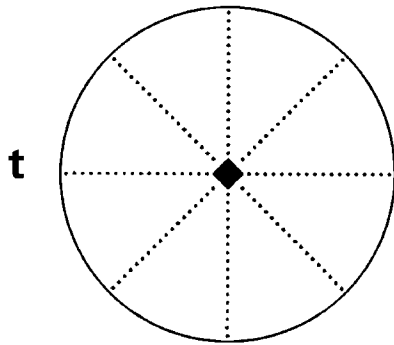

1'

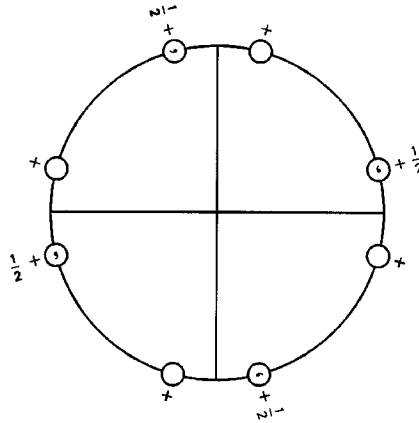

Origin on $4cc1'$

Asymmetric unit $0 \leq x$; $0 \leq y$; $0 \leq z \leq 1/2$

Symmetry operations

For $1 +$ set

- | | | | |
|--|--|---|---|
| (1) 1
($1 0,0,0$) | (2) 2 $0,0,z$
($2_z 0,0,0$) | (3) 4^+ $0,0,z$
($4_z 0,0,0$) | (4) 4^- $0,0,z$
($4_z^{-1} 0,0,0$) |
| (5) c $(0,0,1/2)$ $x,0,z$
($m_y 0,0,1/2$) | (6) c $(0,0,1/2)$ $0,y,z$
($m_x 0,0,1/2$) | (7) c $(0,0,1/2)$ x,\bar{x},z
($m_{xy} 0,0,1/2$) | (8) c $(0,0,1/2)$ x,x,z
($m_{\bar{xy}} 0,0,1/2$) |

For $1' +$ set

- | | | | |
|--|--|---|---|
| (1) $1'$
($1 0,0,0$)' | (2) $2'$ $0,0,z$
($2_z 0,0,0$)' | (3) $4^{+'}$ $0,0,z$
($4_z 0,0,0$)' | (4) $4^{-'}$ $0,0,z$
($4_z^{-1} 0,0,0$)' |
| (5) c' $(0,0,1/2)$ $x,0,z$
($m_y 0,0,1/2$)' | (6) c' $(0,0,1/2)$ $0,y,z$
($m_x 0,0,1/2$)' | (7) c' $(0,0,1/2)$ x,\bar{x},z
($m_{xy} 0,0,1/2$)' | (8) c' $(0,0,1/2)$ x,x,z
($m_{\bar{xy}} 0,0,1/2$)' |

Continued

No. 36.2.185

 $p4cc1'$ Generators selected (1); $t(0,0,1)$; (2); (3); (5); $1'$

Positions

Multiplicity, Wyckoff letter, Site symmetry	Coordinates	
	1+	$1' +$
8 b $11'$	(1) $x,y,z [0,0,0]$	(2) $\bar{x},\bar{y},z [0,0,0]$
	(3) $\bar{y},x,z [0,0,0]$	(4) $y,\bar{x},z [0,0,0]$
	(5) $x,\bar{y},z+1/2 [0,0,0]$	(6) $\bar{x},y,z+1/2 [0,0,0]$
	(7) $\bar{y},\bar{x},z+1/2 [0,0,0]$	(8) $y,x,z+1/2 [0,0,0]$
1 a $4..1'$	$0,0,z [0,0,0]$	$0,0,z+1/2 [0,0,0]$

Symmetry of special projections

Along $[001]$ $4mm1'$	Along $[100]$ $p11m1'$ $a^* = c/2$	Along $[110]$ $p11m1'$ $a^* = c/2$
Origin at $0,0,z$	Origin at $x,0,0$	Origin at $x,x,0$

$p4c'c'$

No. 36.3.186

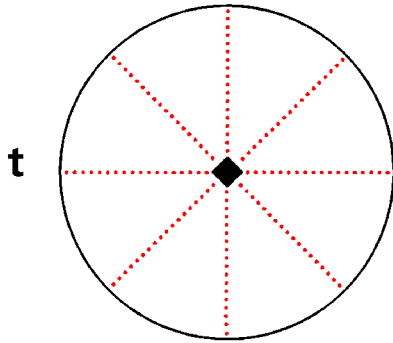

$4m'm'$

$p4c'c'$

Tetragonal

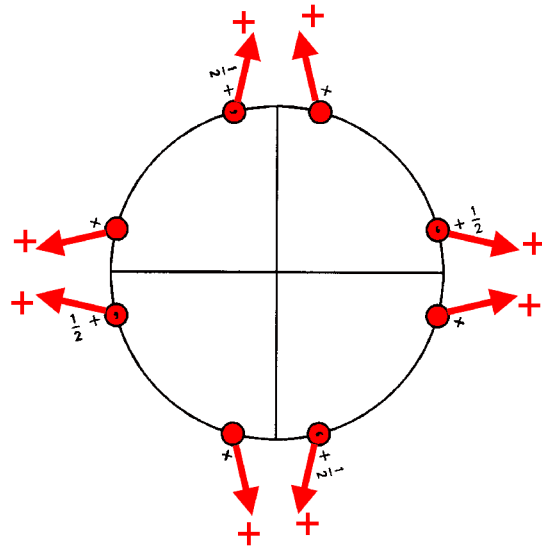

Origin on $4c'c'$

Asymmetric unit $0 \leq x$; $0 \leq y$; $0 \leq z \leq 1/2$

Symmetry operations

(1) 1
(1|0,0,0)

(2) $2_{0,0,z}$
(2_z |0,0,0)

(3) 4^+ $0,0,z$
(4_z |0,0,0)

(4) 4^- $0,0,z$
(4_z^{-1} |0,0,0)

(5) c' (0,0,1/2) $x,0,z$
(m_y |0,0,1/2)'

(6) c' (0,0,1/2) $0,y,z$
(m_x |0,0,1/2)'

(7) c' (0,0,1/2) x,\bar{x},z
(m_{xy} |0,0,1/2)'

(8) c' (0,0,1/2) x,x,z
($m_{\bar{xy}}$ |0,0,1/2)'

Generators selected (1); $t(0,0,1)$; (2); (3); (5)

Positions

Multiplicity, Wyckoff letter, Site symmetry	Coordinates	
		(1) x,y,z [u,v,w]
	(3) \bar{y},x,z [\bar{v},u,w]	(4) y,\bar{x},z [v,\bar{u},w]
	(5) $x,\bar{y},z+1/2$ [u,\bar{v},w]	(6) $\bar{x},y,z+1/2$ [\bar{u},v,w]
	(7) $\bar{y},\bar{x},z+1/2$ [\bar{v},\bar{u},w]	(8) $y,x,z+1/2$ [v,u,w]
8 b 1		
1 a 4..	$0,0,z$ [$0,0,w$]	$0,0,z+1/2$ [$0,0,w$]

Symmetry of special projections

Along [001] $4m'm'$	Along [100] $p11m'$	Along [110] $p11m'$
Origin at $0,0,z$	$a^* = c/2$ Origin at $x,0,0$	$a^* = c/2$ Origin at $x,x,0$

$p4'cc'$

No. 36.4.187

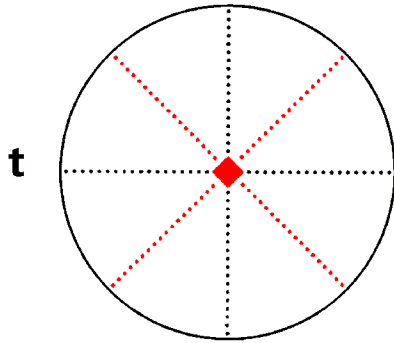

$4'mm'$

$p4'cc'$

Tetragonal

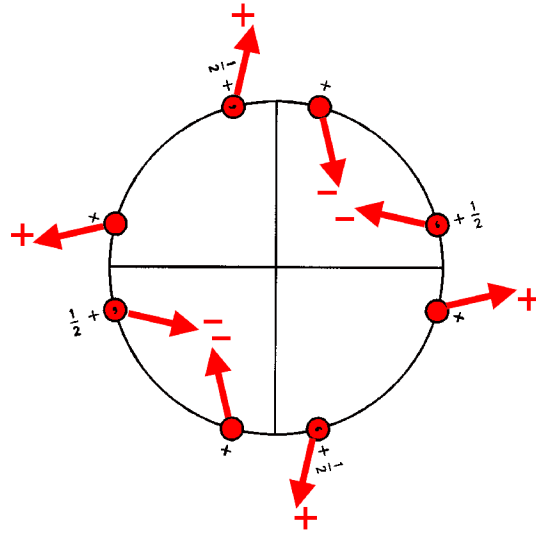

Origin on $4c'$

Asymmetric unit $0 \leq x; 0 \leq y; 0 \leq z \leq 1/2$

Symmetry operations

- | | | | |
|--|--|---|---|
| (1) 1
(1 0,0,0) | (2) 2 $0,0,z$
(2_z 0,0,0) | (3) 4^{+} $0,0,z$
(4_z 0,0,0)' | (4) 4^{-} $0,0,z$
(4_z^{-1} 0,0,0)' |
| (5) c $(0,0,1/2)$ $x,0,z$
(m_y 0,0,1/2) | (6) c $(0,0,1/2)$ $0,y,z$
(m_x 0,0,1/2) | (7) c' $(0,0,1/2)$ x,\bar{x},z
(m_{xy} 0,0,1/2)' | (8) c' $(0,0,1/2)$ x,x,z
($m_{\bar{xy}}$ 0,0,1/2)' |

Generators selected (1); t(0,0,1); (2); (3); (5)

Positions

Multiplicity, Wyckoff letter, Site symmetry	Coordinates		
8 b 1	(1) x, y, z [u, v, w]	(2) \bar{x}, \bar{y}, z [\bar{u}, \bar{v}, w]	
	(3) \bar{y}, x, z [v, \bar{u}, \bar{w}]	(4) y, \bar{x}, z [\bar{v}, u, \bar{w}]	
	(5) $x, \bar{y}, z + 1/2$ [\bar{u}, v, \bar{w}]	(6) $\bar{x}, y, z + 1/2$ [u, \bar{v}, \bar{w}]	
	(7) $\bar{y}, \bar{x}, z + 1/2$ [\bar{v}, \bar{u}, w]	(8) $y, x, z + 1/2$ [v, u, w]	
	1 a 4'..	0,0,z [0,0,0]	0,0,z + 1/2 [0,0,0]

Symmetry of special projections

Along [001] 4'mm'	Along [100] $p_{2a^*}11m'$ $a^* = c/2$	Along [110] $p11m'$ $a^* = c/2$
Origin at 0,0,z	Origin at x,0,0	Origin at x,x,0

$p\bar{4}2m$

No. 37.1.188

$\bar{4}2m$

$p\bar{4}2m$

Tetragonal

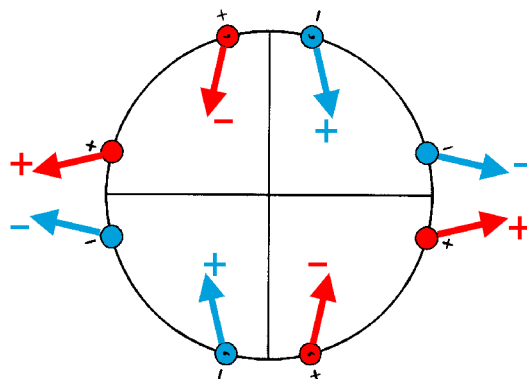
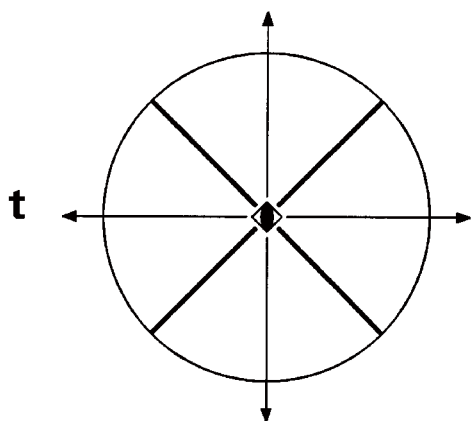

Origin at $\bar{4}2m$

Asymmetric unit $0 \leq x; 0 \leq y; 0 \leq z \leq 1; x \leq y$

Symmetry operations

- | | | | |
|--|--|---|--|
| (1) 1
(1 0,0,0) | (2) 2 $0,0,z$
(2 _z 0,0,0) | (3) $\bar{4}^+$ $0,0,z; 0,0,0$
($\bar{4}_z$ 0,0,0) | (4) $\bar{4}^-$ $0,0,z; 0,0,0$
($\bar{4}_z^{-1}$ 0,0,0) |
| (5) 2 $0,y,0$
(2 _y 0,0,0) | (6) 2 $x,0,0$
(2 _x 0,0,0) | (7) m x,\bar{x},z
(m _{xy} 0,0,0) | (8) m x,x,z
(m _{\bar{xy}} 0,0,0) |

Generators selected (1); $t(0,0,1)$; (2); (3); (5)

Positions

	Coordinates		
Multiplicity, Wyckoff letter, Site symmetry			
8 g 1	(1) x,y,z [u,v,w]	(2) \bar{x},\bar{y},z [\bar{u},\bar{v},w]	
	(3) y,\bar{x},\bar{z} [\bar{v},u,w]	(4) \bar{y},x,\bar{z} [v,\bar{u},w]	
	(5) \bar{x},y,\bar{z} [\bar{u},v,\bar{w}]	(6) x,\bar{y},\bar{z} [u,\bar{v},\bar{w}]	
	(7) \bar{y},\bar{x},z [v,u,\bar{w}]	(8) y,x,z [\bar{v},\bar{u},\bar{w}]	
	4 f $\bar{2}m$	x,x,z [$u,\bar{u},0$]	\bar{x},\bar{x},z [$\bar{u},u,0$]
		x,\bar{x},\bar{z} [$u,u,0$]	\bar{x},x,\bar{z} [$\bar{u},\bar{u},0$]
	4 e $\bar{2}$	$x,0,1/2$ [$u,0,0$]	$\bar{x},0,1/2$ [$\bar{u},0,0$]
		$0,\bar{x},1/2$ [$0,u,0$]	$0,x,1/2$ [$0,\bar{u},0$]
4 d $\bar{2}$	$x,0,0$ [$u,0,0$]	$\bar{x},0,0$ [$\bar{u},0,0$]	
	$0,\bar{x},0$ [$0,u,0$]	$0,x,0$ [$0,\bar{u},0$]	
2 c $2mm$	$0,0,z$ [$0,0,0$]	$0,0,\bar{z}$ [$0,0,0$]	
1 b $\bar{4}2m$	$0,0,1/2$ [$0,0,0$]		
1 a $\bar{4}2m$	$0,0,0$ [$0,0,0$]		

Symmetry of special projections

Along [001] $4'm'm$	Along [100] $p2'mm'$	Along [110] $p11m1'$
Origin at $0,0,z$	$a^* = c$ Origin at $x,0,0$	$a^* = c$ Origin at $x,x,0$

$p\bar{4}2m1'$

No. 37.2.189

$\bar{4}2m1'$

$p\bar{4}2m1'$

Tetragonal

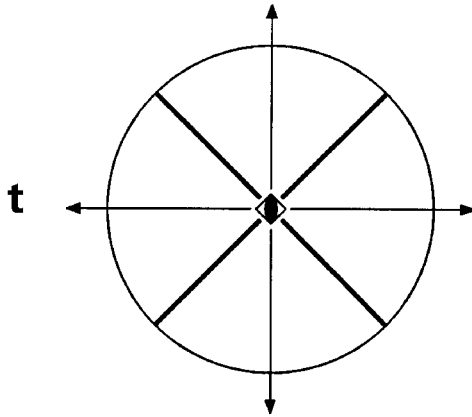

1'

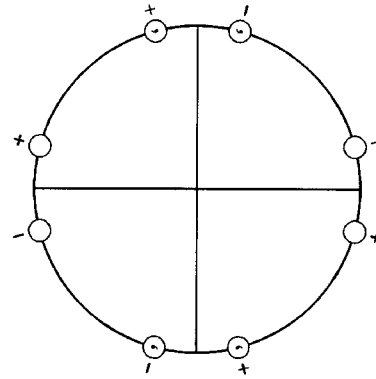

Origin at $\bar{4}2m1'$

Asymmetric unit $0 \leq x; 0 \leq y; 0 \leq z \leq 1; x \leq y$

Symmetry operations

For 1 + set

- | | | | |
|--|--|---|--|
| (1) 1
(1 0,0,0) | (2) 2 0,0,z
(2 _z 0,0,0) | (3) $\bar{4}^+$ 0,0,z; 0,0,0
($\bar{4}_z$ 0,0,0) | (4) $\bar{4}^-$ 0,0,z; 0,0,0
($\bar{4}_z^{-1}$ 0,0,0) |
| (5) 2 0,y,0
(2 _y 0,0,0) | (6) 2 x,0,0
(2 _x 0,0,0) | (7) m x, \bar{x} ,z
(m _{xy} 0,0,0) | (8) m x,x,z
(m _{\bar{xy}} 0,0,0) |

For 1' + set

- | | | | |
|--|--|---|--|
| (1) 1'
(1 0,0,0)' | (2) 2' 0,0,z
(2 _z 0,0,0)' | (3) $\bar{4}^{+'}$ 0,0,z; 0,0,0
($\bar{4}_z$ 0,0,0)' | (4) $\bar{4}^{-'}$ 0,0,z; 0,0,0
($\bar{4}_z^{-1}$ 0,0,0)' |
| (5) 2' 0,y,0
(2 _y 0,0,0)' | (6) 2' x,0,0
(2 _x 0,0,0)' | (7) m' x, \bar{x} ,z
(m _{xy} 0,0,0)' | (8) m' x,x,z
(m _{\bar{xy}} 0,0,0)' |

Generators selected (1); $t(0,0,1)$; (2); (3); (5); $1'$

Positions

Multiplicity, Wyckoff letter, Site symmetry	Coordinates	
	$1+$	$1'+$
8 g $11'$	(1) x,y,z [0,0,0]	(2) \bar{x},\bar{y},z [0,0,0]
	(3) y,\bar{x},\bar{z} [0,0,0]	(4) \bar{y},x,\bar{z} [0,0,0]
	(5) \bar{x},y,\bar{z} [0,0,0]	(6) x,\bar{y},\bar{z} [0,0,0]
	(7) \bar{y},\bar{x},z [0,0,0]	(8) y,x,z [0,0,0]
4 f $.m1'$	x,x,z [0,0,0]	\bar{x},\bar{x},z [0,0,0]
	x,\bar{x},\bar{z} [0,0,0]	\bar{x},x,\bar{z} [0,0,0]
4 e $.2.1'$	$x,0,1/2$ [0,0,0]	$\bar{x},0,1/2$ [0,0,0]
	$0,\bar{x},1/2$ [0,0,0]	$0,x,1/2$ [0,0,0]
4 d $.2.1'$	$x,0,0$ [0,0,0]	$\bar{x},0,0$ [0,0,0]
	$0,\bar{x},0$ [0,0,0]	$0,x,0$ [0,0,0]
2 c $2.mm1'$	$0,0,z$ [0,0,0]	$0,0,\bar{z}$ [0,0,0]
1 b $\bar{4}2m1'$	$0,0,1/2$ [0,0,0]	
1 a $\bar{4}2m1'$	$0,0,0$ [0,0,0]	

Symmetry of special projections

Along [001] $4mm1'$	Along [100] $p2mm1'$	Along [110] $p11m1'$
Origin at $0,0,z$	$a^* = c$ Origin at $x,0,0$	$a^* = c$ Origin at $x,x,0$

$p\bar{4}2'm'$

No. 37.3.190

$\bar{4}2'm'$

$p\bar{4}2'm'$

Tetragonal

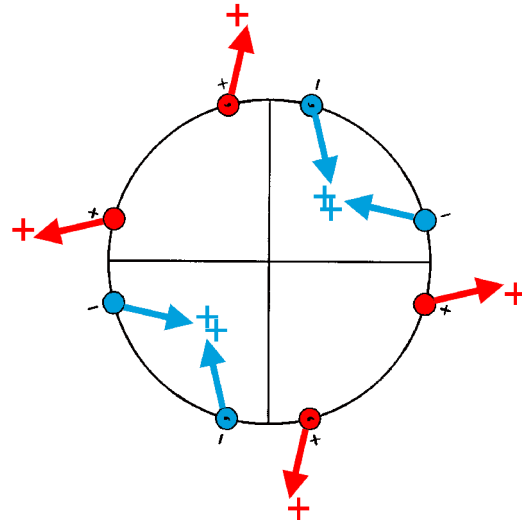
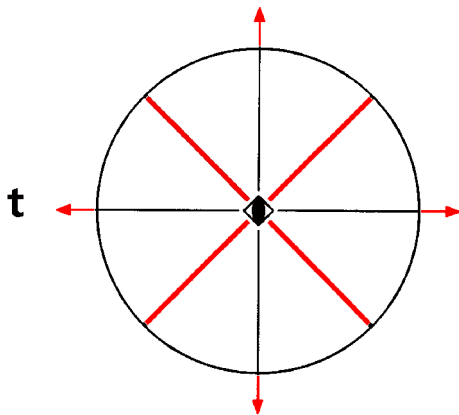

Origin at $\bar{4}2'm'$

Asymmetric unit $0 \leq x; 0 \leq y; 0 \leq z \leq 1; x \leq y$

Symmetry operations

- | | | | |
|--|--|---|--|
| (1) 1
(1 0,0,0) | (2) 2 $0,0,z$
(2 _z 0,0,0) | (3) $\bar{4}^+$ $0,0,z; 0,0,0$
($\bar{4}_z$ 0,0,0) | (4) $\bar{4}^-$ $0,0,z; 0,0,0$
($\bar{4}_z^{-1}$ 0,0,0) |
| (5) 2' $0,y,0$
(2 _y 0,0,0)' | (6) 2' $x,0,0$
(2 _x 0,0,0)' | (7) m' x,\bar{x},z
(m _{xy} 0,0,0)' | (8) m' x,x,z
(m _{xy} 0,0,0)' |

Generators selected (1); $t(0,0,1)$; (2); (3); (5)

Positions

	Coordinates		
Multiplicity, Wyckoff letter, Site symmetry			
8 g 1	(1) x,y,z [u,v,w]	(2) \bar{x},\bar{y},z [\bar{u},\bar{v},w]	
	(3) y,\bar{x},\bar{z} [\bar{v},u,w]	(4) \bar{y},x,\bar{z} [v,\bar{u},w]	
	(5) \bar{x},y,\bar{z} [u,\bar{v},w]	(6) x,\bar{y},\bar{z} [\bar{u},v,w]	
	(7) \bar{y},\bar{x},z [\bar{v},\bar{u},w]	(8) y,x,z [v,u,w]	
	4 f ..m'	x,x,z [u,u,w]	\bar{x},\bar{x},z [\bar{u},\bar{u},w]
		x,\bar{x},\bar{z} [\bar{u},u,w]	\bar{x},x,\bar{z} [u,\bar{u},w]
	4 e .2'	$x,0,1/2$ [$0,v,w$]	$\bar{x},0,1/2$ [$0,\bar{v},w$]
		$0,\bar{x},1/2$ [$\bar{v},0,w$]	$0,x,1/2$ [$v,0,w$]
4 d .2'	$x,0,0$ [$0,v,w$]	$\bar{x},0,0$ [$0,\bar{v},w$]	
	$0,\bar{x},0$ [$\bar{v},0,w$]	$0,x,0$ [$v,0,w$]	
2 c 2.m'm'	$0,0,z$ [$0,0,w$]	$0,0,\bar{z}$ [$0,0,w$]	
1 b $\bar{4}2'm'$	$0,0,1/2$ [$0,0,w$]		
1 a $\bar{4}2'm'$	$0,0,0$ [$0,0,w$]		

Symmetry of special projections

Along [001] $4'mm'$	Along [100] $p2'mm'$	Along [110] $p11m'$
Origin at $0,0,z$	$a^* = c$ Origin at $x,0,0$	$a^* = c$ Origin at $x,x,0$

$p\bar{4}'2m'$

No. 37.4.191

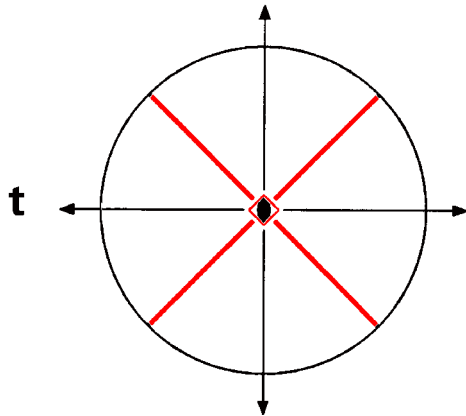

$\bar{4}'2m'$

$p\bar{4}'2m'$

Tetragonal

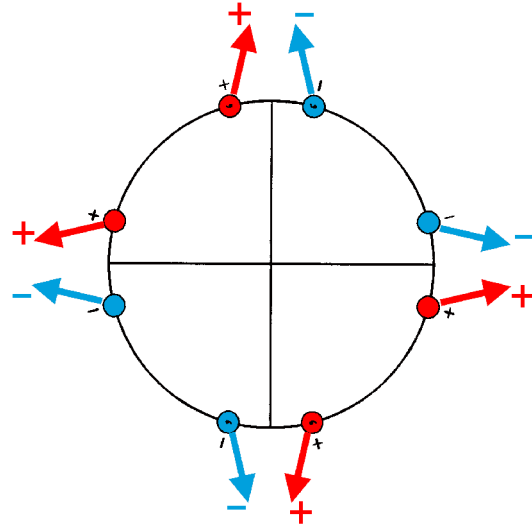

Origin at $\bar{4}'2m'$

Asymmetric unit $0 \leq x; 0 \leq y; 0 \leq z \leq 1; x \leq y$

Symmetry operations

- | | | | |
|--|--|--|---|
| (1) 1
(1 0,0,0) | (2) 2 $0,0,z$
(2 _z 0,0,0) | (3) $\bar{4}'^+$ $0,0,z; 0,0,0$
($\bar{4}'_z$ 0,0,0)' | (4) $\bar{4}'^-$ $0,0,z; 0,0,0$
($\bar{4}'_z^{-1}$ 0,0,0)' |
| (5) 2 $0,y,0$
(2 _y 0,0,0) | (6) 2 $x,0,0$
(2 _x 0,0,0) | (7) m' x,\bar{x},z
(m_{xy} 0,0,0)' | (8) m' x,x,z
($m_{\bar{xy}}$ 0,0,0)' |

Generators selected (1); $t(0,0,1)$; (2); (3); (5)

Positions

	Coordinates		
Multiplicity, Wyckoff letter, Site symmetry			
8 g 1	(1) x,y,z [u,v,w]	(2) \bar{x},\bar{y},z [\bar{u},\bar{v},w]	
	(3) y,\bar{x},\bar{z} [v,\bar{u},\bar{w}]	(4) \bar{y},x,\bar{z} [\bar{v},u,\bar{w}]	
	(5) \bar{x},y,\bar{z} [\bar{u},v,\bar{w}]	(6) x,\bar{y},\bar{z} [u,\bar{v},\bar{w}]	
	(7) \bar{y},\bar{x},z [\bar{v},\bar{u},w]	(8) y,x,z [v,u,w]	
	4 f ..m'	x,x,z [u,u,w]	\bar{x},\bar{x},z [\bar{u},\bar{u},w]
		x,\bar{x},\bar{z} [u,\bar{u},\bar{w}]	\bar{x},x,\bar{z} [\bar{u},u,\bar{w}]
	4 e .2.	$x,0,1/2$ [$u,0,0$]	$\bar{x},0,1/2$ [$\bar{u},0,0$]
		$0,\bar{x},1/2$ [$0,\bar{u},0$]	$0,x,1/2$ [$0,u,0$]
4 d .2.	$x,0,0$ [$u,0,0$]	$\bar{x},0,0$ [$\bar{u},0,0$]	
	$0,\bar{x},0$ [$0,\bar{u},0$]	$0,x,0$ [$0,u,0$]	
2 c 2.m'm'	$0,0,z$ [$0,0,w$]	$0,0,\bar{z}$ [$0,0,\bar{w}$]	
1 b $\bar{4}'2m'$	$0,0,1/2$ [$0,0,0$]		
1 a $\bar{4}'2m'$	$0,0,0$ [$0,0,0$]		

Symmetry of special projections

Along [001] $4m'm'$	Along [100] $p2m'm'$	Along [110] $p11m'$
Origin at $0,0,z$	$a^* = c$ Origin at $x,0,0$	$a^* = c$ Origin at $x,x,0$

$p\bar{4}'2'm$

No. 37.5.192

$\bar{4}'2'm$

$p\bar{4}'2'm$

Tetragonal

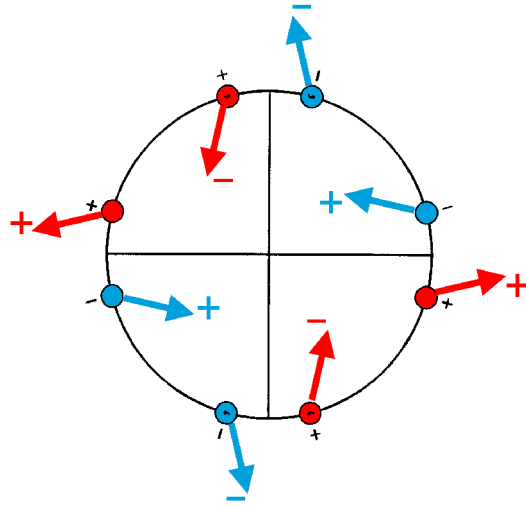
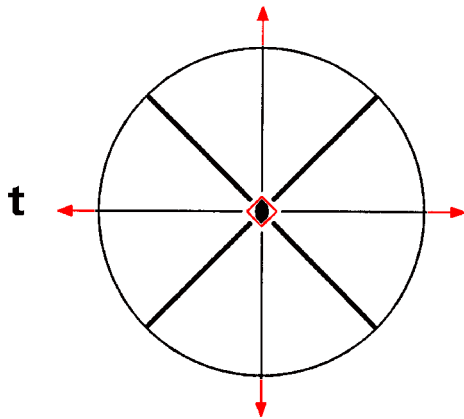

Origin at $\bar{4}'2'm$

Asymmetric unit $0 \leq x; 0 \leq y; 0 \leq z \leq 1; x \leq y$

Symmetry operations

- | | | | |
|--|--|--|---|
| (1) 1
(1 0,0,0) | (2) 2 $0,0,z$
(2 _z 0,0,0) | (3) $\bar{4}^{+}$ $0,0,z; 0,0,0$
($\bar{4}_z$ 0,0,0)' | (4) $\bar{4}^{-}$ $0,0,z; 0,0,0$
($\bar{4}_z^{-1}$ 0,0,0)' |
| (5) 2' $0,y,0$
(2 _y 0,0,0)' | (6) 2' $x,0,0$
(2 _x 0,0,0)' | (7) m x,\bar{x},z
(m _{xy} 0,0,0) | (8) m x,x,z
(m _{\bar{xy}} 0,0,0) |

Generators selected (1); $t(0,0,1)$; (2); (3); (5)

Positions

	Coordinates		
Multiplicity, Wyckoff letter, Site symmetry			
8 g 1	(1) x,y,z [u,v,w]	(2) \bar{x},\bar{y},z [\bar{u},\bar{v},w]	
	(3) y,\bar{x},\bar{z} [v,\bar{u},\bar{w}]	(4) \bar{y},x,\bar{z} [\bar{v},u,\bar{w}]	
	(5) \bar{x},y,\bar{z} [u,\bar{v},w]	(6) x,\bar{y},\bar{z} [\bar{u},v,w]	
	(7) \bar{y},\bar{x},z [v,u,\bar{w}]	(8) y,x,z [\bar{v},\bar{u},\bar{w}]	
	4 f $\bar{2}.m$	x,x,z [$u,\bar{u},0$]	\bar{x},\bar{x},z [$\bar{u},u,0$]
		x,\bar{x},\bar{z} [$\bar{u},\bar{u},0$]	\bar{x},x,\bar{z} [$u,u,0$]
	4 e $\bar{2}'$	$x,0,1/2$ [$0,v,w$]	$\bar{x},0,1/2$ [$0,\bar{v},w$]
		$0,\bar{x},1/2$ [$v,0,\bar{w}$]	$0,x,1/2$ [$\bar{v},0,\bar{w}$]
4 d $\bar{2}'$	$x,0,0$ [$0,v,w$]	$\bar{x},0,0$ [$0,\bar{v},w$]	
	$0,\bar{x},0$ [$v,0,\bar{w}$]	$0,x,0$ [$\bar{v},0,\bar{w}$]	
2 c $2.mm$	$0,0,z$ [$0,0,0$]	$0,0,\bar{z}$ [$0,0,0$]	
1 b $\bar{4}'2'm$	$0,0,1/2$ [$0,0,0$]		
1 a $\bar{4}'2'm$	$0,0,0$ [$0,0,0$]		

Symmetry of special projections

Along [001] $4mm$	Along [100] $p2'mm'$	Along [110] $p11m1'$
Origin at $0,0,z$	$a^* = c$ Origin at $x,0,0$	$a^* = c$ Origin at $x,x,0$

$p_{2c}\bar{4}2'm'$

No. 37.6.193

$\bar{4}2m1'$

$p_{2c}\bar{4}2'm'$

Tetragonal

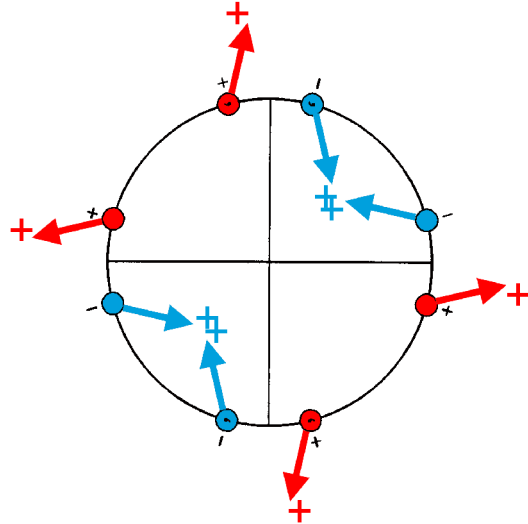
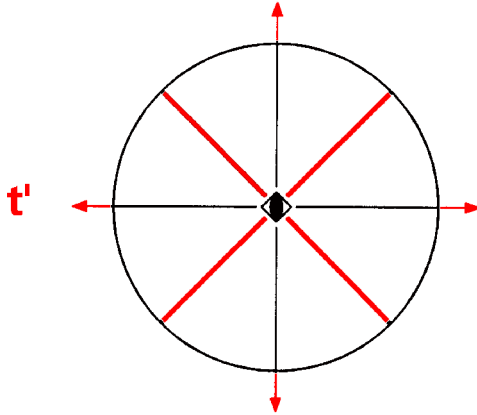

Origin at $\bar{4}2'm'$

Asymmetric unit $0 \leq x; 0 \leq y; 0 \leq z \leq 1; x \leq y$

Symmetry operations

For (0,0,0) + set

- | | | | |
|--|--|---|--|
| (1) 1
(1 0,0,0) | (2) 2 0,0,z
(2 _z 0,0,0) | (3) $\bar{4}^+$ 0,0,z; 0,0,0
($\bar{4}_z$ 0,0,0) | (4) $\bar{4}^-$ 0,0,z; 0,0,0
($\bar{4}_z^{-1}$ 0,0,0) |
| (5) 2' 0,y,0
(2 _y 0,0,0)' | (6) 2' x,0,0
(2 _x 0,0,0)' | (7) m' x, \bar{x} ,z
(m _{xy} 0,0,0)' | (8) m' x,x,z
(m _{xy} 0,0,0)' |

For (0,0,1)' + set

- | | | | |
|--|--|---|---|
| (1) t' (0,0,1)
(1 0,0,1)' | (2) 2' (0,0,1) 0,0,z
(2 _z 0,0,1)' | (3) $\bar{4}^+$ 0,0,z; 0,0,1/2
($\bar{4}_z$ 0,0,1)' | (4) $\bar{4}^-$ 0,0,z; 0,0,1/2
($\bar{4}_z^{-1}$ 0,0,1)' |
| (5) 2 0,y,1/2
(2 _y 0,0,1) | (6) 2 x,0,1/2
(2 _x 0,0,1) | (7) c (0,0,1) x, \bar{x} ,z
(m _{xy} 0,0,1) | (8) c (0,0,1) x,x,z
(m _{xy} 0,0,1) |

Generators selected (1); $t(0,0,1)'$; (2); (3); (5)

Positions

Multiplicity, Wyckoff letter, Site symmetry	Coordinates	
	(0,0,0)+	(0,0,1)' +
8 g 1	(1) x,y,z [u,v,w] (3) y, \bar{x} , \bar{z} [\bar{v} ,u,w] (5) \bar{x} ,y, \bar{z} [u, \bar{v} ,w] (7) \bar{y} , \bar{x} ,z [\bar{v} , \bar{u} ,w]	(2) \bar{x} , \bar{y} ,z [\bar{u} , \bar{v} ,w] (4) \bar{y} ,x, \bar{z} [v, \bar{u} ,w] (6) x, \bar{y} , \bar{z} [\bar{u} ,v,w] (8) y,x,z [v,u,w]
4 f ..m'	x,x,z [u,u,w] x, \bar{x} , \bar{z} [\bar{u} ,u,w]	\bar{x} , \bar{x} ,z [\bar{u} , \bar{u} ,w] \bar{x} ,x, \bar{z} [u, \bar{u} ,w]
4 e .2.	x,0,1/2 [u,0,0] 0, \bar{x} ,1/2 [0,u,0]	\bar{x} ,0,1/2 [\bar{u} ,0,0] 0,x,1/2 [0, \bar{u} ,0]
4 d .2'	x,0,0 [0,v,w] 0, \bar{x} ,0 [\bar{v} ,0,w]	\bar{x} ,0,0 [0, \bar{v} ,w] 0,x,0 [v,0,w]
2 c 2.m'm'	0,0,z [0,0,w]	0,0, \bar{z} [0,0,w]
1 b $\bar{4}2m'$	0,0,1/2 [0,0,0]	
1 a $\bar{4}2m'$	0,0,0 [0,0,w]	

Symmetry of special projections

Along [001] 4mm1'

Origin at 0,0,z

Along [100] $\rho_{2a^*} 2'mm'$ $a^* = c$

Origin at x,0,0

Along [110] $\rho_{2a^*} 11m'$ $a^* = c$

Origin at x,x,0

$p_{2c}\bar{4}2m$

$\bar{4}2m$

Tetragonal

No. 37.7.194

$p_{2c}\bar{4}2m$

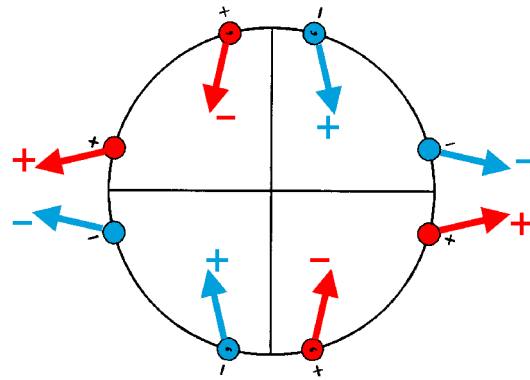
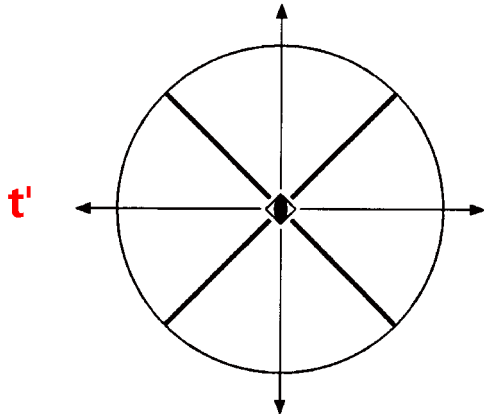

Origin at $\bar{4}2m$

Asymmetric unit $0 \leq x; 0 \leq y; 0 \leq z \leq 1; x \leq y$

Symmetry operations

For (0,0,0) + set

- | | | | |
|--|--|---|--|
| (1) 1
(1 0,0,0) | (2) 2 0,0,z
(2 _z 0,0,0) | (3) $\bar{4}^+$ 0,0,z; 0,0,0
($\bar{4}_z$ 0,0,0) | (4) $\bar{4}^-$ 0,0,z; 0,0,0
($\bar{4}_z^{-1}$ 0,0,0) |
| (5) 2 0,y,0
(2 _y 0,0,0) | (6) 2 x,0,0
(2 _x 0,0,0) | (7) m x, \bar{x} ,z
(m _{xy} 0,0,0) | (8) m x,x,z
(m _{xy} 0,0,0) |

For (0,0,1)' + set

- | | | | |
|--|--|---|--|
| (1) t' (0,0,1)
(1 0,0,1)' | (2) 2' (0,0,1) 0,0,z
(2 _z 0,0,1)' | (3) $\bar{4}^{+'}$ 0,0,z; 0,0,1/2
($\bar{4}_z$ 0,0,1)' | (4) $\bar{4}^{-'}$ 0,0,z; 0,0,1/2
($\bar{4}_z^{-1}$ 0,0,1)' |
| (5) 2' 0,y,1/2
(2 _y 0,0,1)' | (6) 2' x,0,1/2
(2 _x 0,0,1)' | (7) c' (0,0,1) x, \bar{x} ,z
(m _{xy} 0,0,1)' | (8) c' (0,0,1) x,x,z
(m _{xy} 0,0,1)' |

Generators selected (1); $t(0,0,1)'$; (2); (3); (5)

Positions

Multiplicity, Wyckoff letter, Site symmetry	Coordinates	
	(0,0,0)+	(0,0,1)' +
8 g 1	(1) x,y,z [u,v,w] (3) y, \bar{x} , \bar{z} [\bar{v} ,u,w] (5) \bar{x} ,y, \bar{z} [\bar{u} ,v, \bar{w}] (7) \bar{y} , \bar{x} ,z [v,u, \bar{w}]	(2) \bar{x} , \bar{y} ,z [\bar{u} , \bar{v} ,w] (4) \bar{y} ,x, \bar{z} [v, \bar{u} ,w] (6) x, \bar{y} , \bar{z} [u, \bar{v} , \bar{w}] (8) y,x,z [\bar{v} , \bar{u} , \bar{w}]
4 f ..m	x,x,z [u, \bar{u} ,0] x, \bar{x} , \bar{z} [u,u,0]	\bar{x} , \bar{x} ,z [\bar{u} ,u,0] \bar{x} ,x, \bar{z} [\bar{u} , \bar{u} ,0]
4 e .2'	x,0,1/2 [0,v,w] 0, \bar{x} ,1/2 [v,0, \bar{w}]	\bar{x} ,0,1/2 [0, \bar{v} ,w] 0,x,1/2 [\bar{v} ,0, \bar{w}]
4 d .2.	x,0,0 [u,0,0] 0, \bar{x} ,0 [0,u,0]	\bar{x} ,0,0 [\bar{u} ,0,0] 0,x,0 [0, \bar{u} ,0]
2 c 2.mm	0,0,z [0,0,0]	0,0, \bar{z} [0,0,0]
1 b $\bar{4}'2'm$	0,0,1/2 [0,0,0]	
1 a $\bar{4}2m$	0,0,0 [0,0,0]	

Symmetry of special projections

Along [001] 4mm1'	Along [100] $p_{2a^*} 2m'm'$	Along [110] $p11m1'$
Origin at 0,0,z	$a^* = c$ Origin at x,0,0	$a^* = c$ Origin at x,x,0

$p\bar{4}2c$

No. 38.1.195

$\bar{4}2m$

$p\bar{4}2c$

Tetragonal

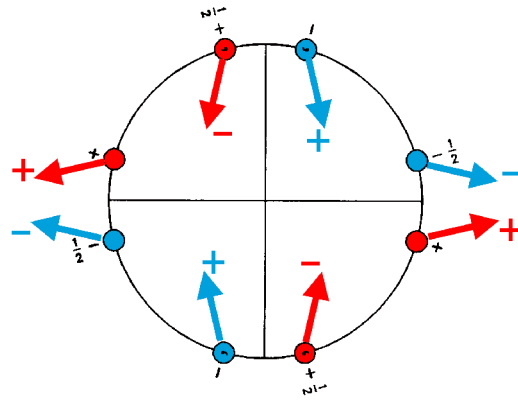
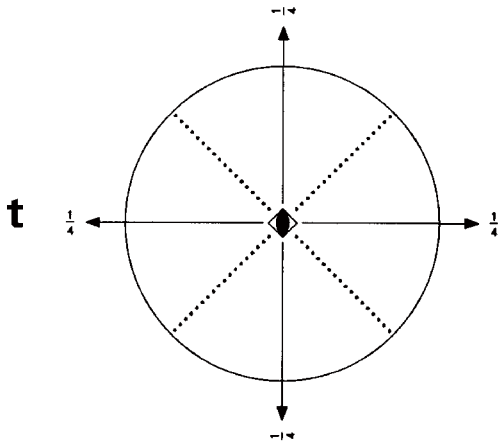

Origin at $\bar{4}1c$

Asymmetric unit $0 \leq x; 0 \leq y; 0 \leq z \leq 1/2$

Symmetry operations

- | | | | |
|--|--|---|--|
| (1) 1
(1 0,0,0) | (2) 2 $0,0,z$
(2 _z 0,0,0) | (3) $\bar{4}^+$ $0,0,z; 0,0,0$
($\bar{4}_z$ 0,0,0) | (4) $\bar{4}^-$ $0,0,z; 0,0,0$
($\bar{4}_z^{-1}$ 0,0,0) |
| (5) 2 $0,y,1/4$
(2 _y 0,0,1/2) | (6) 2 $x,0,1/4$
(2 _x 0,0,1/2) | (7) c $(0,0,1/2) \ x,\bar{x},z$
(m _{xy} 0,0,1/2) | (8) c $(0,0,1/2) \ x,x,z$
(m _{xy} 0,0,1/2) |

Generators selected (1); $t(0,0,1)$; (2); (3); (5)

Positions

Multiplicity, Wyckoff letter, Site symmetry	Coordinates	
	(1)	(2)
8 f 1	(1) x,y,z [u,v,w]	(2) \bar{x},\bar{y},z [\bar{u},\bar{v},w]
	(3) y,\bar{x},\bar{z} [\bar{v},u,w]	(4) \bar{y},x,\bar{z} [v,\bar{u},w]
	(5) $\bar{x},y,\bar{z}+1/2$ [\bar{u},v,\bar{w}]	(6) $x,\bar{y},\bar{z}+1/2$ [u,\bar{v},\bar{w}]
	(7) $\bar{y},\bar{x},z+1/2$ [v,u,\bar{w}]	(8) $y,x,z+1/2$ [\bar{v},\bar{u},\bar{w}]
4 e 2..	$0,0,z$ [0,0,w]	$0,0,\bar{z}$ [0,0,w]
	$0,0,\bar{z}+1/2$ [0,0, \bar{w}]	$0,0,z+1/2$ [0,0, \bar{w}]
4 d .2.	$0,y,1/4$ [0,v,0]	$0,\bar{y},1/4$ [0, $\bar{v},0$]
	$y,0,3/4$ [$\bar{v},0,0$]	$\bar{y},0,3/4$ [$v,0,0$]
4 c .2.	$x,0,1/4$ [u,0,0]	$\bar{x},0,1/4$ [$\bar{u},0,0$]
	$0,\bar{x},3/4$ [0,u,0]	$0,x,3/4$ [0, $\bar{u},0$]
2 b $\bar{4}$..	$0,0,0$ [0,0,w]	$0,0,1/2$ [0,0, \bar{w}]
1 a 222.	$0,0,1/4$ [0,0,0]	$0,0,3/4$ [0,0,0]

Symmetry of special projections

Along [001] $4'm'm$	Along [100] $p2m'm'$	Along [110] $p_{2a^*}11m'$
Origin at 0,0,z	$a^* = c$ Origin at $x,0,1/4$	$a^* = c/2$ Origin at $x,x,0$

$p\bar{4}2c1'$

$\bar{4}2m1'$

Tetragonal

No. 38.2.196

$p\bar{4}2c1'$

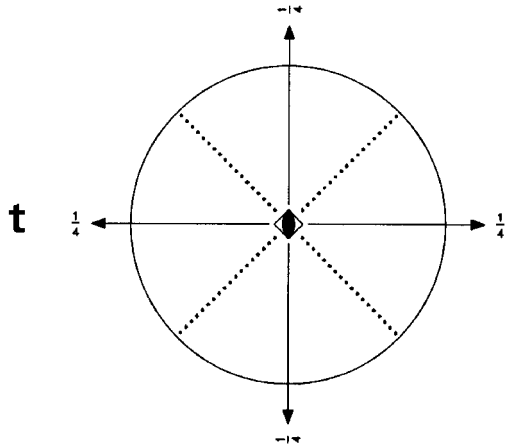

1'

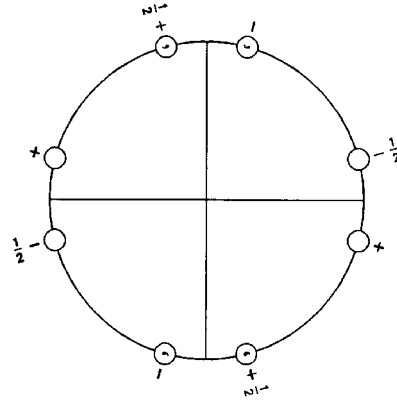

Origin at $\bar{4}1c1'$

Asymmetric unit $0 \leq x; 0 \leq y; 0 \leq z \leq 1/2$

Symmetry operations

For 1 + set

- | | | | |
|--|--|---|--|
| (1) 1
(1 0,0,0) | (2) 2 0,0,z
(2 _z 0,0,0) | (3) $\bar{4}^+$ 0,0,z; 0,0,0
($\bar{4}_z$ 0,0,0) | (4) $\bar{4}^-$ 0,0,z; 0,0,0
($\bar{4}_z^{-1}$ 0,0,0) |
| (5) 2 0,y,1/4
(2 _y 0,0,1/2) | (6) 2 x,0,1/4
(2 _x 0,0,1/2) | (7) c (0,0,1/2) x, \bar{x} ,z
(m _{xy} 0,0,1/2) | (8) c (0,0,1/2) x,x,z
(m _{xy} 0,0,1/2) |

For 1' + set

- | | | | |
|--|--|---|--|
| (1) 1'
(1 0,0,0)' | (2) 2' 0,0,z
(2 _z 0,0,0)' | (3) $\bar{4}^{+'}$ 0,0,z; 0,0,0
($\bar{4}_z$ 0,0,0)' | (4) $\bar{4}^{-'}$ 0,0,z; 0,0,0
($\bar{4}_z^{-1}$ 0,0,0)' |
| (5) 2' 0,y,1/4
(2 _y 0,0,1/2)' | (6) 2' x,0,1/4
(2 _x 0,0,1/2)' | (7) c' (0,0,1/2) x, \bar{x} ,z
(m _{xy} 0,0,1/2)' | (8) c' (0,0,1/2) x,x,z
(m _{xy} 0,0,1/2)' |

Generators selected (1); $t(0,0,1)$; (2); (3); (5); $1'$

Positions

Multiplicity, Wyckoff letter, Site symmetry	Coordinates	
	$1+$	$1' +$
8 f $11'$	(1) x,y,z [0,0,0]	(2) \bar{x},\bar{y},z [0,0,0]
	(3) y,\bar{x},\bar{z} [0,0,0]	(4) \bar{y},x,\bar{z} [0,0,0]
	(5) $\bar{x},y,\bar{z}+1/2$ [0,0,0]	(6) $x,\bar{y},\bar{z}+1/2$ [0,0,0]
	(7) $\bar{y},\bar{x},z+1/2$ [0,0,0]	(8) $y,x,z+1/2$ [0,0,0]
4 e $2..1'$	$0,0,z$ [0,0,0]	$0,0,\bar{z}$ [0,0,0]
	$0,0,\bar{z}+1/2$ [0,0,0]	$0,0,z+1/2$ [0,0,0]
4 d $.2.1'$	$0,y,1/4$ [0,0,0]	$0,\bar{y},1/4$ [0,0,0]
	$y,0,3/4$ [0,0,0]	$\bar{y},0,3/4$ [0,0,0]
4 c $.2.1'$	$x,0,1/4$ [0,0,0]	$\bar{x},0,1/4$ [0,0,0]
	$0,\bar{x},3/4$ [0,0,0]	$0,x,3/4$ [0,0,0]
2 b $\bar{4}..1'$	$0,0,0$ [0,0,0]	$0,0,1/2$ [0,0,0]
1 a $222.1'$	$0,0,1/4$ [0,0,0]	$0,0,3/4$ [0,0,0]

Symmetry of special projections

Along [001] $4mm1'$	Along [100] $p2mm1'$	Along [110] $p11m1'$
Origin at 0,0,z	$a^* = c$ Origin at $x,0,1/4$	$a^* = c/2$ Origin at $x,x,0$

$p\bar{4}2'c'$

No. 38.3.197

$\bar{4}2'm'$

$p\bar{4}2'c'$

Tetragonal

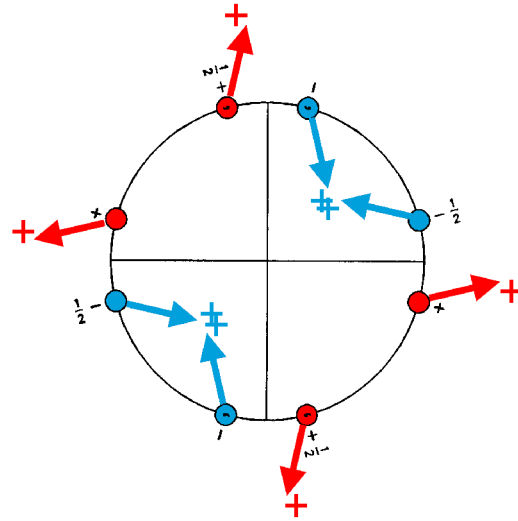
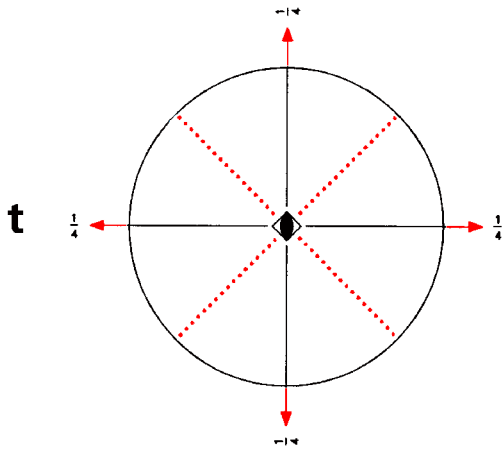

Origin at $\bar{4}1c'$

Asymmetric unit $0 \leq x; 0 \leq y; 0 \leq z \leq 1/2$

Symmetry operations

- | | | | |
|--|--|---|---|
| (1) 1
(1 0,0,0) | (2) 2 $0,0,z$
(2 _z 0,0,0) | (3) $\bar{4}^+$ $0,0,z; 0,0,0$
($\bar{4}_z$ 0,0,0) | (4) $\bar{4}^-$ $0,0,z; 0,0,0$
($\bar{4}_z^{-1}$ 0,0,0) |
| (5) 2' $0,y,1/4$
(2 _y 0,0,1/2)' | (6) 2' $x,0,1/4$
(2 _x 0,0,1/2)' | (7) c' $(0,0,1/2) \quad x,\bar{x},z$
(m _{xy} 0,0,1/2)' | (8) c' $(0,0,1/2) \quad x,x,z$
(m _{xy} 0,0,1/2)' |

Generators selected (1); $t(0,0,1)$; (2); (3); (5)

Positions

	Coordinates		
Multiplicity, Wyckoff letter, Site symmetry			
8 f 1	(1) x,y,z [u,v,w]	(2) \bar{x},\bar{y},z [\bar{u},\bar{v},w]	
	(3) y,\bar{x},\bar{z} [\bar{v},u,w]	(4) \bar{y},x,\bar{z} [v,\bar{u},w]	
	(5) $\bar{x},y,\bar{z}+1/2$ [u,\bar{v},w]	(6) $x,\bar{y},\bar{z}+1/2$ [\bar{u},v,w]	
	(7) $\bar{y},\bar{x},z+1/2$ [\bar{v},\bar{u},w]	(8) $y,x,z+1/2$ [v,u,w]	
	4 e 2..	$0,0,z$ [0,0,w]	$0,0,\bar{z}$ [0,0,w]
		$0,0,\bar{z}+1/2$ [0,0,w]	$0,0,z+1/2$ [0,0,w]
	4 d .2'	$0,y,1/4$ [u,0,w]	$0,\bar{y},1/4$ [$\bar{u},0,w$]
		$y,0,3/4$ [0,u,w]	$\bar{y},0,3/4$ [0, \bar{u},w]
4 c .2'	$x,0,1/4$ [0,v,w]	$\bar{x},0,1/4$ [0, \bar{v},w]	
	$0,\bar{x},3/4$ [$\bar{v},0,w$]	$0,x,3/4$ [$v,0,w$]	
2 b $\bar{4}$..	$0,0,0$ [0,0,w]	$0,0,1/2$ [0,0,w]	
1 a $22'2'$.	$0,0,1/4$ [0,0,w]	$0,0,3/4$ [0,0,w]	

Symmetry of special projections

Along [001] $4'mm'$	Along [100] $p2'm'm$	Along [110] $p11m'$
Origin at 0,0,z	$a^* = c$ Origin at $x,0,1/4$	$a^* = c/2$ Origin at $x,x,0$

$p\bar{4}'2c'$

No. 38.4.198

$\bar{4}'2m'$

$p\bar{4}'2c'$

Tetragonal

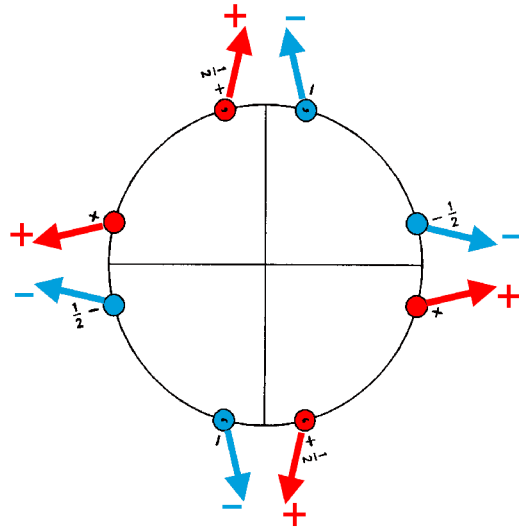
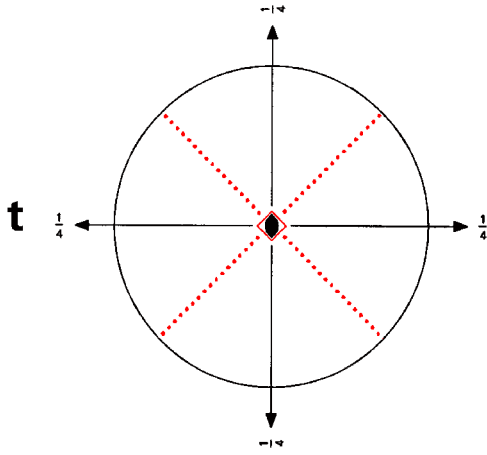

Origin at $\bar{4}'1c'$

Asymmetric unit $0 \leq x; 0 \leq y; 0 \leq z \leq 1/2$

Symmetry operations

- | | | | |
|--------------------------------------|--------------------------------------|--|---|
| (1) 1
(1 0,0,0) | (2) 2 $0,0,z$
(2_z 0,0,0) | (3) $\bar{4}'^+$ $0,0,z; 0,0,0$
($\bar{4}'_z$ 0,0,0)' | (4) $\bar{4}'^-$ $0,0,z; 0,0,0$
($\bar{4}'_z^{-1}$ 0,0,0)' |
| (5) 2 $0,y,1/4$
(2_y 0,0,1/2) | (6) 2 $x,0,1/4$
(2_x 0,0,1/2) | (7) c' (0,0,1/2) x,\bar{x},z
(m_{xy} 0,0,1/2)' | (8) c' (0,0,1/2) x,x,z
($m_{\bar{xy}}$ 0,0,1/2)' |

Generators selected (1); $t(0,0,1)$; (2); (3); (5)

Positions

Multiplicity, Wyckoff letter, Site symmetry	Coordinates		
	(1)	(2)	
8 f 1	(1) x,y,z [u,v,w]	(2) \bar{x},\bar{y},z [\bar{u},\bar{v},w]	
	(3) y,\bar{x},\bar{z} [v, \bar{u},\bar{w}]	(4) \bar{y},x,\bar{z} [\bar{v},u,\bar{w}]	
	(5) $\bar{x},y,\bar{z}+1/2$ [\bar{u},v,\bar{w}]	(6) $x,\bar{y},\bar{z}+1/2$ [u,\bar{v},\bar{w}]	
	(7) $\bar{y},\bar{x},z+1/2$ [\bar{v},\bar{u},w]	(8) $y,x,z+1/2$ [v,u,w]	
	4 e 2..	0,0,z [0,0,w]	0,0, \bar{z} [0,0, \bar{w}]
		0,0, $\bar{z}+1/2$ [0,0, \bar{w}]	0,0,z+1/2 [0,0,w]
	4 d .2.	0,y,1/4 [0,v,0]	0, \bar{y} ,1/4 [0, \bar{v} ,0]
		y,0,3/4 [v,0,0]	\bar{y} ,0,3/4 [\bar{v} ,0,0]
4 c .2.	x,0,1/4 [u,0,0]	\bar{x} ,0,1/4 [\bar{u} ,0,0]	
	0, \bar{x} ,3/4 [0, \bar{u} ,0]	0,x,3/4 [0,u,0]	
2 b $\bar{4}'$..	0,0,0 [0,0,0]	0,0,1/2 [0,0,0]	
1 a 222.	0,0,1/4 [0,0,0]	0,0,3/4 [0,0,0]	

Symmetry of special projections

Along [001] $4m'm'$	Along [100] $p2m'm'$	Along [110] $p11m'$
Origin at 0,0,z	$a^* = c$ Origin at x,0,1/4	$a^* = c/2$ Origin at x,x,0

$p\bar{4}'2'c$

$\bar{4}'2'm$

Tetragonal

No. 38.5.199

$p\bar{4}'2'c$

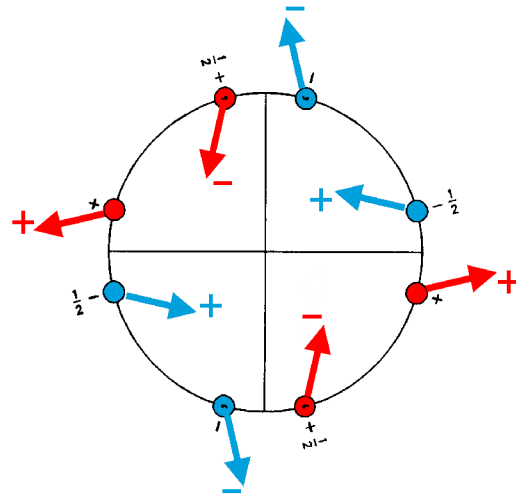
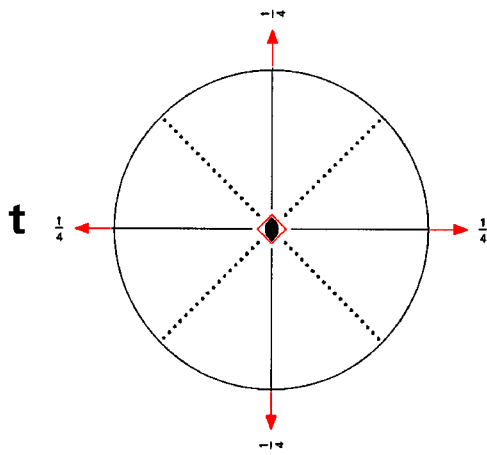

Origin at $\bar{4}'1c$

Asymmetric unit $0 \leq x; 0 \leq y; 0 \leq z \leq 1/2$

Symmetry operations

- | | | | |
|--|--|---|---|
| (1) 1
(1 0,0,0) | (2) 2 $0,0,z$
(2 _z 0,0,0) | (3) $\bar{4}^+$ $0,0,z; 0,0,0$
($\bar{4}_z$ 0,0,0)' | (4) $\bar{4}^-$ $0,0,z; 0,0,0$
($\bar{4}_z^{-1}$ 0,0,0)' |
| (5) 2' $0,y,1/4$
(2 _y 0,0,1/2)' | (6) 2' $x,0,1/4$
(2 _x 0,0,1/2)' | (7) c (0,0,1/2) x,\bar{x},z
(m _{xy} 0,0,1/2) | (8) c (0,0,1/2) x,x,z
(m _{xy} 0,0,1/2) |

Generators selected (1); $t(0,0,1)$; (2); (3); (5)

Positions

Multiplicity, Wyckoff letter, Site symmetry	Coordinates		
8 f 1	(1) x,y,z [u,v,w]	(2) \bar{x},\bar{y},z [\bar{u},\bar{v},w]	
	(3) y,\bar{x},\bar{z} [v, \bar{u},\bar{w}]	(4) \bar{y},x,\bar{z} [\bar{v},u,\bar{w}]	
	(5) $\bar{x},y,\bar{z}+1/2$ [u, \bar{v},w]	(6) $x,\bar{y},\bar{z}+1/2$ [\bar{u},v,w]	
	(7) $\bar{y},\bar{x},z+1/2$ [v,u, \bar{w}]	(8) $y,x,z+1/2$ [\bar{v},\bar{u},\bar{w}]	
	4 e 2..	0,0,z [0,0,w]	0,0, \bar{z} [0,0, \bar{w}]
		0,0, $\bar{z}+1/2$ [0,0,w]	0,0,z+1/2 [0,0, \bar{w}]
	4 d .2'.	0,y,1/4 [u,0,w]	0, \bar{y} ,1/4 [$\bar{u},0,w$]
		y,0,3/4 [0, \bar{u},\bar{w}]	\bar{y} ,0,3/4 [0,u, \bar{w}]
4 c .2'.	x,0,1/4 [0,v,w]	\bar{x} ,0,1/4 [0, \bar{v},w]	
	0, \bar{x} ,3/4 [v,0, \bar{w}]	0,x,3/4 [$\bar{v},0,\bar{w}$]	
2 b $\bar{4}'$..	0,0,0 [0,0,0]	0,0,1/2 [0,0,0]	
1 a 22'2'.	0,0,1/4 [0,0,w]	0,0,3/4 [0,0, \bar{w}]	

Symmetry of special projections

Along [001] 4mm	Along [100] $\rho 2'mm'$ $a^* = c$	Along [110] $\rho_{2a^*} 11m'$ $a^* = c/2$
Origin at 0,0,z	Origin at x,0,1/4	Origin at x,x,0

$p4/mmm$

$4/mmm$

Tetragonal

No. 39.1.200

$p4/m2/m2/m$

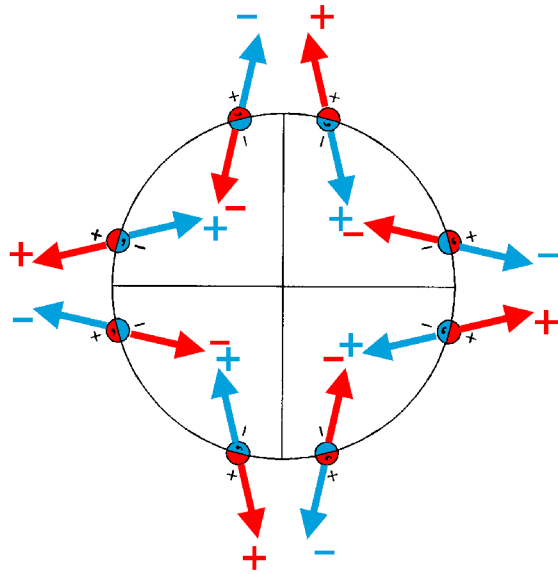
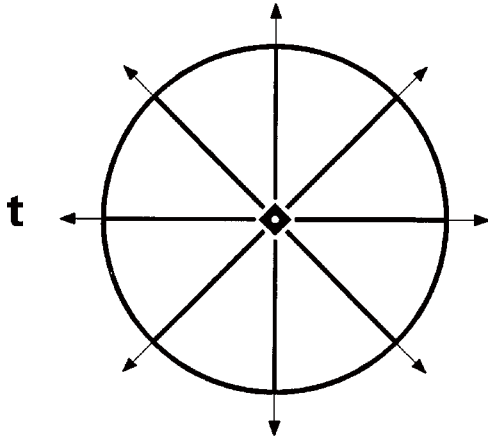

Origin at center ($4/mmm$)

Asymmetric unit $0 \leq x; 0 \leq y; 0 \leq z \leq 1/2; x \leq y$

Symmetry operations

- | | | | |
|--|---|---|--|
| (1) 1
(1 0,0,0) | (2) 2 0,0,z
(2 _z 0,0,0) | (3) 4 ⁺ 0,0,z
(4 _z 0,0,0) | (4) 4 ⁻ 0,0,z
(4 _z ⁻¹ 0,0,0) |
| (5) 2 0,y,0
(2 _y 0,0,0) | (6) 2 x,0,0
(2 _x 0,0,0) | (7) 2 x,x,0
(2 _{xy} 0,0,0) | (8) 2 x, \bar{x} ,0
(2 _{\bar{xy}} 0,0,0) |
| (9) $\bar{1}$ 0,0,0
($\bar{1}$ 0,0,0) | (10) m x,y,0
(m _z 0,0,0) | (11) $\bar{4}$ ⁺ 0,0,z; 0,0,0
($\bar{4}$ _z ⁺ 0,0,0) | (12) $\bar{4}$ ⁻ 0,0,z; 0,0,0
($\bar{4}$ _z ⁻¹ 0,0,0) |
| (13) m x,0,z
(m _y 0,0,0) | (14) m 0,y,z
(m _x 0,0,0) | (15) m x, \bar{x} ,z
(m _{xy} 0,0,0) | (16) m x,x,z
(m _{\bar{xy}} 0,0,0) |

Generators selected (1); t(0,0,1); (2); (3); (5); (9)

Positions

	Coordinates			
Multiplicity, Wyckoff letter, Site symmetry				
16 l 1	(1) x,y,z [u,v,w]	(2) \bar{x},\bar{y},z [\bar{u},\bar{v},w]	(3) \bar{y},x,z [\bar{v},u,w]	(4) y, \bar{x},z [v, \bar{u},w]
	(5) \bar{x},y,\bar{z} [\bar{u},v,\bar{w}]	(6) x, \bar{y},\bar{z} [u, \bar{v},\bar{w}]	(7) y,x, \bar{z} [v,u, \bar{w}]	(8) \bar{y},\bar{x},\bar{z} [\bar{v},\bar{u},\bar{w}]
	(9) \bar{x},\bar{y},\bar{z} [u,v,w]	(10) x,y, \bar{z} [\bar{u},\bar{v},w]	(11) y, \bar{x},\bar{z} [\bar{v},u,w]	(12) \bar{y},x,\bar{z} [v, \bar{u},w]
	(13) x, \bar{y},z [\bar{u},v,\bar{w}]	(14) \bar{x},y,z [u, \bar{v},\bar{w}]	(15) \bar{y},\bar{x},z [v,u, \bar{w}]	(16) y,x,z [\bar{v},\bar{u},\bar{w}]
8 k .m.	x,0,z [0,v,0]	$\bar{x},0,z$ [0, $\bar{v},0$]	0,x,z [$\bar{v},0,0$]	0, \bar{x},z [v,0,0]
	$\bar{x},0,\bar{z}$ [0,v,0]	x,0, \bar{z} [0, $\bar{v},0$]	0,x, \bar{z} [v,0,0]	0, \bar{x},\bar{z} [$\bar{v},0,0$]
8 j ..m	x,x,z [u, $\bar{u},0$]	\bar{x},\bar{x},z [$\bar{u},u,0$]	\bar{x},x,z [u,u,0]	x, \bar{x},z [$\bar{u},\bar{u},0$]
	\bar{x},x,\bar{z} [$\bar{u},\bar{u},0$]	x, \bar{x},\bar{z} [u,u,0]	x,x, \bar{z} [$\bar{u},u,0$]	\bar{x},\bar{x},\bar{z} [u, $\bar{u},0$]
8 i m..	x,y,1/2 [0,0,w]	$\bar{x},\bar{y},1/2$ [0,0,w]	$\bar{y},x,1/2$ [0,0,w]	y, $\bar{x},1/2$ [0,0,w]
	$\bar{x},y,1/2$ [0,0, \bar{w}]	x, $\bar{y},1/2$ [0,0, \bar{w}]	y,x,1/2 [0,0, \bar{w}]	$\bar{y},\bar{x},1/2$ [0,0, \bar{w}]
8 h m..	x,y,0 [0,0,w]	$\bar{x},\bar{y},0$ [0,0,w]	$\bar{y},x,0$ [0,0,w]	y, $\bar{x},0$ [0,0,w]
	$\bar{x},y,0$ [0,0, \bar{w}]	x, $\bar{y},0$ [0,0, \bar{w}]	y,x,0 [0,0, \bar{w}]	$\bar{y},\bar{x},0$ [0,0, \bar{w}]
4 g m2m.	x,0,1/2 [0,0,0]	$\bar{x},0,1/2$ [0,0,0]	0,x,1/2 [0,0,0]	0, $\bar{x},1/2$ [0,0,0]
4 f m2m.	x,0,0 [0,0,0]	$\bar{x},0,0$ [0,0,0]	0,x,0 [0,0,0]	0, $\bar{x},0$ [0,0,0]
4 e m.2m	x,x,1/2 [0,0,0]	$\bar{x},\bar{x},1/2$ [0,0,0]	$\bar{x},x,1/2$ [0,0,0]	x, $\bar{x},1/2$ [0,0,0]
4 d m.2m	x,x,0 [0,0,0]	$\bar{x},\bar{x},0$ [0,0,0]	$\bar{x},x,0$ [0,0,0]	x, $\bar{x},0$ [0,0,0]

Continued

No. 39.1.200

$p4/mmm$

2 c $4mm$ $0,0,z$ $[0,0,0]$ $0,0,\bar{z}$ $[0,0,0]$

1 b $4/mmm$ $0,0,1/2$ $[0,0,0]$

1 a $4/mmm$ $0,0,0$ $[0,0,0]$

Symmetry of special projections

Along $[001]$ $4mm1'$	Along $[100]$ $p2mm1'$	Along $[110]$ $p2mm1'$
	$a^* = c$	$a^* = c$
Origin at $0,0,z$	Origin at $x,0,0$	Origin at $x,x,0$

$p4/mmm1'$

$4/mmm1'$

Tetragonal

No. 39.2.201

$p4/m2/m2/m1'$

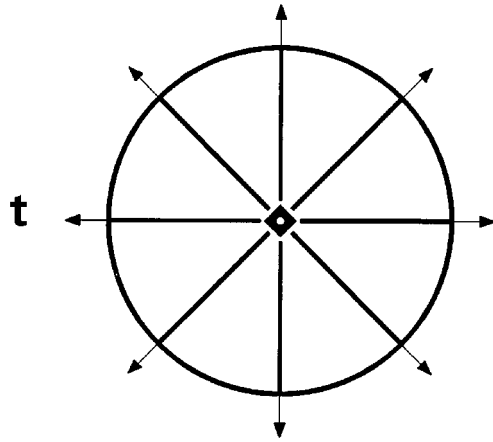

1'

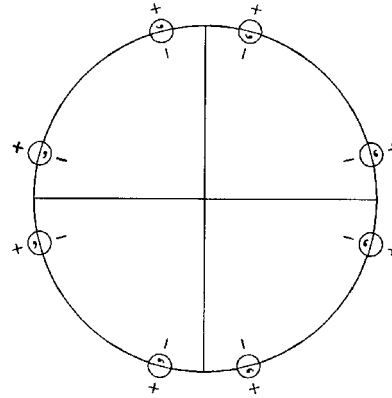

Origin at center ($4/mmm1'$)

Asymmetric unit $0 \leq x; 0 \leq y; 0 \leq z \leq 1/2; x \leq y$

Symmetry operations

For $1 +$ set

- | | | | |
|--|-------------------------------------|--|---|
| (1) 1
($1 0,0,0$) | (2) 2 $0,0,z$
($2_z 0,0,0$) | (3) 4^+ $0,0,z$
($4_z 0,0,0$) | (4) 4^- $0,0,z$
($4_z^{-1} 0,0,0$) |
| (5) 2 $0,y,0$
($2_y 0,0,0$) | (6) 2 $x,0,0$
($2_x 0,0,0$) | (7) 2 $x,x,0$
($2_{xy} 0,0,0$) | (8) 2 $x,\bar{x},0$
($2_{\bar{xy}} 0,0,0$) |
| (9) $\bar{1}$ $0,0,0$
($\bar{1} 0,0,0$) | (10) m $x,y,0$
($m_z 0,0,0$) | (11) $\bar{4}^+$ $0,0,z; 0,0,0$
($\bar{4}_z 0,0,0$) | (12) $\bar{4}^-$ $0,0,z; 0,0,0$
($\bar{4}_z^{-1} 0,0,0$) |
| (13) m $x,0,z$
($m_y 0,0,0$) | (14) m $0,y,z$
($m_x 0,0,0$) | (15) m x,\bar{x},z
($m_{xy} 0,0,0$) | (16) m x,x,z
($m_{\bar{xy}} 0,0,0$) |

For $1' +$ set

- | | | | |
|--|---------------------------------------|--|---|
| (1) $1'$
($1 0,0,0$)' | (2) $2'$ $0,0,z$
($2_z 0,0,0$)' | (3) $4^{+'}$ $0,0,z$
($4_z 0,0,0$)' | (4) $4^{-'}$ $0,0,z$
($4_z^{-1} 0,0,0$)' |
| (5) $2'$ $0,y,0$
($2_y 0,0,0$)' | (6) $2'$ $x,0,0$
($2_x 0,0,0$)' | (7) $2'$ $x,x,0$
($2_{xy} 0,0,0$)' | (8) $2'$ $x,\bar{x},0$
($2_{\bar{xy}} 0,0,0$)' |
| (9) $\bar{1}'$ $0,0,0$
($\bar{1} 0,0,0$)' | (10) m' $x,y,0$
($m_z 0,0,0$)' | (11) $\bar{4}^{+'}$ $0,0,z; 0,0,0$
($\bar{4}_z 0,0,0$)' | (12) $\bar{4}^{-'}$ $0,0,z; 0,0,0$
($\bar{4}_z^{-1} 0,0,0$)' |
| (13) m' $x,0,z$
($m_y 0,0,0$)' | (14) m' $0,y,z$
($m_x 0,0,0$)' | (15) m' x,\bar{x},z
($m_{xy} 0,0,0$)' | (16) m' x,x,z
($m_{\bar{xy}} 0,0,0$)' |

Generators selected (1); t(0,0,1); (2); (3); (5); (9); 1'

Positions

Multiplicity, Wyckoff letter, Site symmetry	Coordinates			
	1+	1'+		
16 l 11'	(1) x,y,z [0,0,0]	(2) \bar{x},\bar{y},z [0,0,0]	(3) \bar{y},x,z [0,0,0]	(4) y, \bar{x},z [0,0,0]
	(5) \bar{x},y,\bar{z} [0,0,0]	(6) x, \bar{y},\bar{z} [0,0,0]	(7) y,x, \bar{z} [0,0,0]	(8) \bar{y},\bar{x},\bar{z} [0,0,0]
	(9) \bar{x},\bar{y},\bar{z} [0,0,0]	(10) x,y, \bar{z} [0,0,0]	(11) y, \bar{x},\bar{z} [0,0,0]	(12) \bar{y},x,\bar{z} [0,0,0]
	(13) x, \bar{y},z [0,0,0]	(14) \bar{x},y,z [0,0,0]	(15) \bar{y},\bar{x},z [0,0,0]	(16) y,x,z [0,0,0]
8 k .m.1'	x,0,z [0,0,0]	$\bar{x},0,z$ [0,0,0]	0,x,z [0,0,0]	0, \bar{x},z [0,0,0]
	$\bar{x},0,\bar{z}$ [0,0,0]	x,0, \bar{z} [0,0,0]	0,x, \bar{z} [0,0,0]	0, \bar{x},\bar{z} [0,0,0]
8 j ..m1'	x,x,z [0,0,0]	\bar{x},\bar{x},z [0,0,0]	\bar{x},x,z [0,0,0]	x, \bar{x},z [0,0,0]
	\bar{x},x,\bar{z} [0,0,0]	x, \bar{x},\bar{z} [0,0,0]	x,x, \bar{z} [0,0,0]	\bar{x},\bar{x},\bar{z} [0,0,0]
8 i m..1'	x,y,1/2 [0,0,0]	$\bar{x},\bar{y},1/2$ [0,0,0]	$\bar{y},x,1/2$ [0,0,0]	y, $\bar{x},1/2$ [0,0,0]
	$\bar{x},y,1/2$ [0,0,0]	x, $\bar{y},1/2$ [0,0,0]	y,x,1/2 [0,0,0]	$\bar{y},\bar{x},1/2$ [0,0,0]
8 h m..1'	x,y,0 [0,0,0]	$\bar{x},\bar{y},0$ [0,0,0]	$\bar{y},x,0$ [0,0,0]	y, $\bar{x},0$ [0,0,0]
	$\bar{x},y,0$ [0,0,0]	x, $\bar{y},0$ [0,0,0]	y,x,0 [0,0,0]	$\bar{y},\bar{x},0$ [0,0,0]
4 g m2m.1'	x,0,1/2 [0,0,0]	$\bar{x},0,1/2$ [0,0,0]	0,x,1/2 [0,0,0]	0, $\bar{x},1/2$ [0,0,0]
4 f m2m.1'	x,0,0 [0,0,0]	$\bar{x},0,0$ [0,0,0]	0,x,0 [0,0,0]	0, $\bar{x},0$ [0,0,0]
4 e m.2m1'	x,x,1/2 [0,0,0]	$\bar{x},\bar{x},1/2$ [0,0,0]	$\bar{x},x,1/2$ [0,0,0]	x, $\bar{x},1/2$ [0,0,0]
4 d m.2m1'	x,x,0 [0,0,0]	$\bar{x},\bar{x},0$ [0,0,0]	$\bar{x},x,0$ [0,0,0]	x, $\bar{x},0$ [0,0,0]

Continued

No. 39.2.201

$p4/mmm1'$

2 c $4mm1'$ $0,0,z [0,0,0]$ $0,0,\bar{z} [0,0,0]$

1 b $4/mmm1'$ $0,0,1/2 [0,0,0]$

1 a $4/mmm1'$ $0,0,0 [0,0,0]$

Symmetry of special projections

Along $[001]$ $4mm1'$	Along $[100]$ $p2mm1'$	Along $[110]$ $p2mm1'$
	$a^* = c$	$a^* = c$
Origin at $0,0,z$	Origin at $x,0,0$	Origin at $x,x,0$

$p4/m'm'm'$

No. 39.3.202

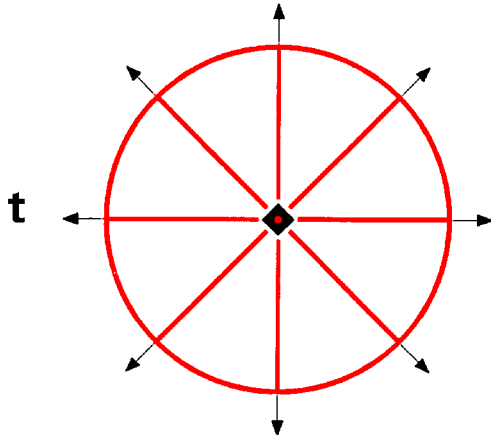

$4/m'm'm'$

$p4/m'2/m'2/m'$

Tetragonal

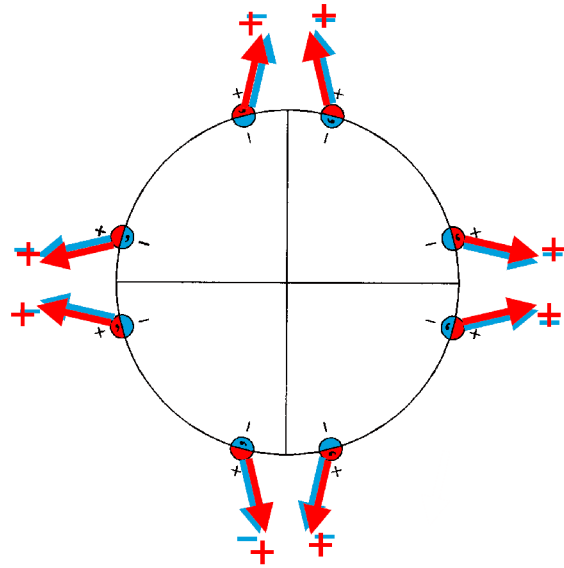

Origin at center ($4/m'm'm'$)

Asymmetric unit $0 \leq x; 0 \leq y; 0 \leq z \leq 1/2; x \leq y$

Symmetry operations

- | | | | |
|---|---|--|--|
| (1) 1
(1 0,0,0) | (2) 2 0,0,z
(2 _z 0,0,0) | (3) 4 ⁺ 0,0,z
(4 _z 0,0,0) | (4) 4 ⁻ 0,0,z
(4 _z ⁻¹ 0,0,0) |
| (5) 2 0,y,0
(2 _y 0,0,0) | (6) 2 x,0,0
(2 _x 0,0,0) | (7) 2 x,x,0
(2 _{xy} 0,0,0) | (8) 2 x,̄x,0
(2 _{̄xy} 0,0,0) |
| (9) ̄1 0,0,0
(̄1 0,0,0)' | (10) m' x,y,0
(m _z 0,0,0)' | (11) ̄4 ⁺ 0,0,z; 0,0,0
(̄4 _z 0,0,0)' | (12) ̄4 ⁻ 0,0,z; 0,0,0
(̄4 _z ⁻¹ 0,0,0)' |
| (13) m' x,0,z
(m _y 0,0,0)' | (14) m' 0,y,z
(m _x 0,0,0)' | (15) m' x,̄x,z
(m _{xy} 0,0,0)' | (16) m' x,x,z
(m _{̄xy} 0,0,0)' |

Generators selected (1); t(0,0,1); (2); (3); (5); (9)

Positions

	Coordinates			
Multiplicity, Wyckoff letter, Site symmetry				
16 l 1	(1) x,y,z [u,v,w]	(2) \bar{x},\bar{y},z [\bar{u},\bar{v},w]	(3) \bar{y},x,z [\bar{v},u,w]	(4) y, \bar{x},z [v, \bar{u},w]
	(5) \bar{x},y,\bar{z} [\bar{u},v,\bar{w}]	(6) x, \bar{y},\bar{z} [u, \bar{v},\bar{w}]	(7) y,x, \bar{z} [v,u, \bar{w}]	(8) \bar{y},\bar{x},\bar{z} [\bar{v},\bar{u},\bar{w}]
	(9) \bar{x},\bar{y},\bar{z} [\bar{u},\bar{v},\bar{w}]	(10) x,y, \bar{z} [u,v, \bar{w}]	(11) y, \bar{x},\bar{z} [v, \bar{u},\bar{w}]	(12) \bar{y},x,\bar{z} [\bar{v},u,\bar{w}]
	(13) x, \bar{y},z [u, \bar{v},w]	(14) \bar{x},y,z [\bar{u},v,w]	(15) \bar{y},\bar{x},z [\bar{v},\bar{u},w]	(16) y,x,z [v,u,w]
8 k .m'	x,0,z [u,0,w]	$\bar{x},0,z$ [$\bar{u},0,w$]	0,x,z [0,u,w]	0, \bar{x},z [0, \bar{u},w]
	$\bar{x},0,\bar{z}$ [$\bar{u},0,\bar{w}$]	x,0, \bar{z} [u,0, \bar{w}]	0,x, \bar{z} [0,u, \bar{w}]	0, \bar{x},\bar{z} [0, \bar{u},\bar{w}]
8 j ..m'	x,x,z [u,u,w]	\bar{x},\bar{x},z [\bar{u},\bar{u},w]	\bar{x},x,z [\bar{u},u,w]	x, \bar{x},z [u, \bar{u},w]
	\bar{x},x,\bar{z} [\bar{u},u,\bar{w}]	x, \bar{x},\bar{z} [u, \bar{u},\bar{w}]	x,x, \bar{z} [u,u, \bar{w}]	\bar{x},\bar{x},\bar{z} [\bar{u},\bar{u},\bar{w}]
8 i m'..	x,y,1/2 [u,v,0]	$\bar{x},\bar{y},1/2$ [$\bar{u},\bar{v},0$]	$\bar{y},x,1/2$ [$\bar{v},u,0$]	y, $\bar{x},1/2$ [v, $\bar{u},0$]
	$\bar{x},y,1/2$ [$\bar{u},v,0$]	x, $\bar{y},1/2$ [u, $\bar{v},0$]	y,x,1/2 [v,u,0]	$\bar{y},\bar{x},1/2$ [$\bar{v},\bar{u},0$]
8 h m'..	x,y,0 [u,v,0]	$\bar{x},\bar{y},0$ [$\bar{u},\bar{v},0$]	$\bar{y},x,0$ [$\bar{v},u,0$]	y, $\bar{x},0$ [v, $\bar{u},0$]
	$\bar{x},y,0$ [$\bar{u},v,0$]	x, $\bar{y},0$ [u, $\bar{v},0$]	y,x,0 [v,u,0]	$\bar{y},\bar{x},0$ [$\bar{v},\bar{u},0$]
4 g m'2m'	x,0,1/2 [u,0,0]	$\bar{x},0,1/2$ [$\bar{u},0,0$]	0,x,1/2 [0,u,0]	0, $\bar{x},1/2$ [0, $\bar{u},0$]
4 f m'2m'	x,0,0 [u,0,0]	$\bar{x},0,0$ [$\bar{u},0,0$]	0,x,0 [0,u,0]	0, $\bar{x},0$ [0, $\bar{u},0$]
4 e m'.2m'	x,x,1/2 [u,u,0]	$\bar{x},\bar{x},1/2$ [$\bar{u},\bar{u},0$]	$\bar{x},x,1/2$ [$\bar{u},u,0$]	x, $\bar{x},1/2$ [u, $\bar{u},0$]
4 d m'.2m'	x,x,0 [u,u,0]	$\bar{x},\bar{x},0$ [$\bar{u},\bar{u},0$]	$\bar{x},x,0$ [$\bar{u},u,0$]	x, $\bar{x},0$ [u, $\bar{u},0$]

Continued

No. 39.3.202

$p4/m'm'm'$

2 c $4m'm'$ $0,0,z [0,0,w]$ $0,0,\bar{z} [0,0,\bar{w}]$

1 b $4/m'm'm'$ $0,0,1/2 [0,0,0]$

1 a $4/m'm'm'$ $0,0,0 [0,0,0]$

Symmetry of special projections

Along $[001]$ $4m'm'$	Along $[100]$ $p2m'm'$	Along $[110]$ $p2m'm'$
Origin at $0,0,z$	$a^* = c$ Origin at $x,0,0$	$a^* = c$ Origin at $x,x,0$

$p4/mm'm'$

No. 39.4.203

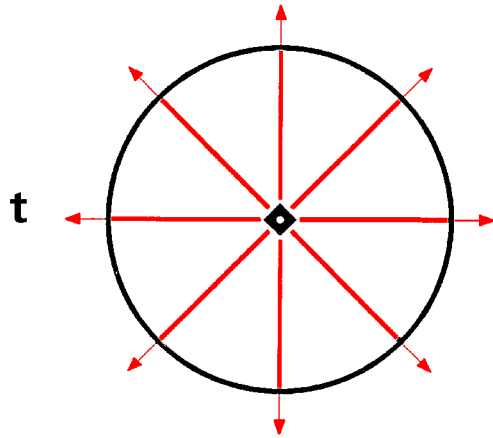

$4/mm'm'$

$p4/m2'/m2'/m'$

Tetragonal

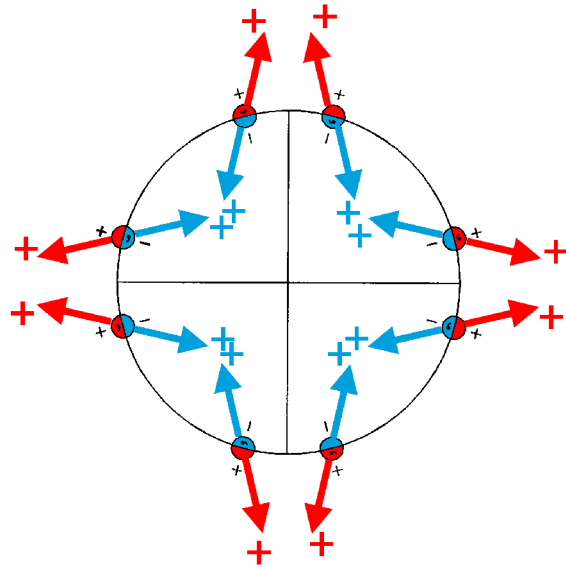

Origin at center ($4/mm'm'$)

Asymmetric unit $0 \leq x$; $0 \leq y$; $0 \leq z \leq 1/2$; $x \leq y$

Symmetry operations

- | | | | |
|--|---|--|--|
| (1) 1
(1 0,0,0) | (2) 2 0,0,z
(2 _z 0,0,0) | (3) 4 ⁺ 0,0,z
(4 _z 0,0,0) | (4) 4 ⁻ 0,0,z
(4 _z ⁻¹ 0,0,0) |
| (5) 2' 0,y,0
(2 _y 0,0,0)' | (6) 2' x,0,0
(2 _x 0,0,0)' | (7) 2' x,x,0
(2 _{xy} 0,0,0)' | (8) 2' x, \bar{x} ,0
(2 _{\bar{y}} 0,0,0)' |
| (9) $\bar{1}$ 0,0,0
($\bar{1}$ 0,0,0) | (10) m x,y,0
(m _z 0,0,0) | (11) $\bar{4}$ ⁺ 0,0,z; 0,0,0
($\bar{4}$ _z 0,0,0) | (12) $\bar{4}$ ⁻ 0,0,z; 0,0,0
($\bar{4}$ _z ⁻¹ 0,0,0) |
| (13) m' x,0,z
(m _y 0,0,0)' | (14) m' 0,y,z
(m _x 0,0,0)' | (15) m' x, \bar{x} ,z
(m _{xy} 0,0,0)' | (16) m' x,x,z
(m _{\bar{y}} 0,0,0)' |

Generators selected (1); t(0,0,1); (2); (3); (5); (9)

Positions

	Coordinates			
Multiplicity, Wyckoff letter, Site symmetry				
16 l 1	(1) x,y,z [u,v,w]	(2) \bar{x},\bar{y},z [\bar{u},\bar{v},w]	(3) \bar{y},x,z [\bar{v},u,w]	(4) y, \bar{x},z [v, \bar{u},w]
	(5) \bar{x},y,\bar{z} [\bar{u},\bar{v},w]	(6) x, \bar{y},\bar{z} [\bar{u},v,w]	(7) y,x, \bar{z} [\bar{v},\bar{u},w]	(8) \bar{y},\bar{x},\bar{z} [v,u,w]
	(9) \bar{x},\bar{y},\bar{z} [u,v,w]	(10) x,y, \bar{z} [\bar{u},\bar{v},w]	(11) y, \bar{x},\bar{z} [\bar{v},u,w]	(12) \bar{y},x,\bar{z} [v, \bar{u},w]
	(13) x, \bar{y},z [u, \bar{v},w]	(14) \bar{x},y,z [\bar{u},v,w]	(15) \bar{y},\bar{x},z [\bar{v},\bar{u},w]	(16) y,x,z [v,u,w]
8 k .m'	x,0,z [u,0,w]	$\bar{x},0,z$ [$\bar{u},0,w$]	0,x,z [0,u,w]	0, \bar{x},z [0, \bar{u},w]
	$\bar{x},0,\bar{z}$ [u,0,w]	x,0, \bar{z} [$\bar{u},0,w$]	0,x, \bar{z} [0, \bar{u},w]	0, \bar{x},\bar{z} [0,u,w]
8 j ..m'	x,x,z [u,u,w]	\bar{x},\bar{x},z [\bar{u},\bar{u},w]	\bar{x},x,z [\bar{u},u,w]	x, \bar{x},z [u, \bar{u},w]
	\bar{x},x,\bar{z} [u, \bar{u},w]	x, \bar{x},\bar{z} [\bar{u},u,w]	x,x, \bar{z} [\bar{u},\bar{u},w]	\bar{x},\bar{x},\bar{z} [u,u,w]
8 i m..	x,y,1/2 [0,0,w]	$\bar{x},\bar{y},1/2$ [0,0,w]	$\bar{y},x,1/2$ [0,0,w]	y, $\bar{x},1/2$ [0,0,w]
	$\bar{x},y,1/2$ [0,0,w]	x, $\bar{y},1/2$ [0,0,w]	y,x,1/2 [0,0,w]	$\bar{y},\bar{x},1/2$ [0,0,w]
8 h m..	x,y,0 [0,0,w]	$\bar{x},\bar{y},0$ [0,0,w]	$\bar{y},x,0$ [0,0,w]	y, $\bar{x},0$ [0,0,w]
	$\bar{x},y,0$ [0,0,w]	x, $\bar{y},0$ [0,0,w]	y,x,0 [0,0,w]	$\bar{y},\bar{x},0$ [0,0,w]
4 g m2'm'	x,0,1/2 [0,0,w]	$\bar{x},0,1/2$ [0,0,w]	0,x,1/2 [0,0,w]	0, $\bar{x},1/2$ [0,0,w]
4 f m2'm'	x,0,0 [0,0,w]	$\bar{x},0,0$ [0,0,w]	0,x,0 [0,0,w]	0, $\bar{x},0$ [0,0,w]
4 e m.2'm'	x,x,1/2 [0,0,w]	$\bar{x},\bar{x},1/2$ [0,0,w]	$\bar{x},x,1/2$ [0,0,w]	x, $\bar{x},1/2$ [0,0,w]
4 d m.2'm'	x,x,0 [0,0,w]	$\bar{x},\bar{x},0$ [0,0,w]	$\bar{x},x,0$ [0,0,w]	x, $\bar{x},0$ [0,0,w]

Continued

No. 39.4.203

$p4/mm'm'$

2 c $4m'm'$ $0,0,z [0,0,w]$ $0,0,\bar{z} [0,0,w]$

1 b $4/mm'm'$ $0,0,1/2 [0,0,w]$

1 a $4/mm'm'$ $0,0,0 [0,0,w]$

Symmetry of special projections

Along $[001]$ $4mm1'$	Along $[100]$ $p2'mm'$ $a^* = c$	Along $[110]$ $p2'mm'$ $a^* = c$
Origin at $0,0,z$	Origin at $x,0,0$	Origin at $x,x,0$

$p4/m'mm$

No. 39.5.204

$4/m'mm$

$p4/m'2'/m2'/m$

Tetragonal

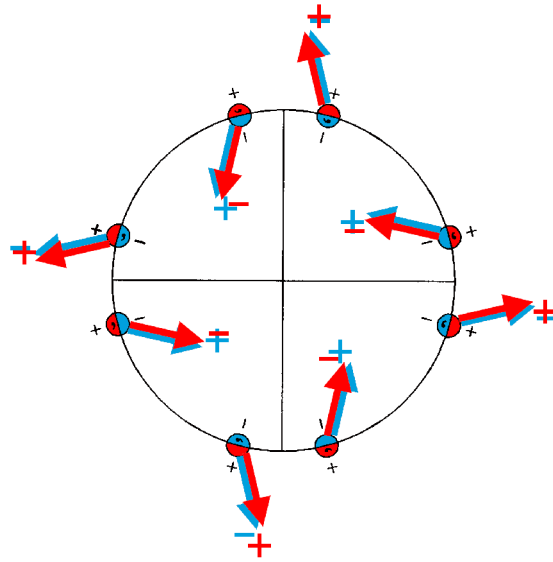
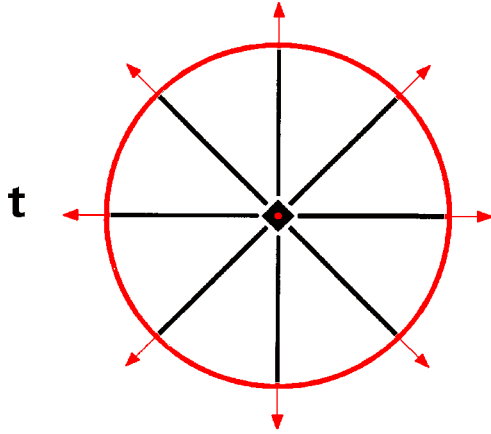

Origin at center ($4/m'mm$)

Asymmetric unit $0 \leq x; 0 \leq y; 0 \leq z \leq 1/2; x \leq y$

Symmetry operations

- | | | | |
|---|--|--|--|
| (1) 1
(1 0,0,0) | (2) 2 _z 0,0,z
(2 _z 0,0,0) | (3) 4 ⁺ 0,0,z
(4 _z 0,0,0) | (4) 4 ⁻ 0,0,z
(4 _z ⁻¹ 0,0,0) |
| (5) 2' _y 0,y,0
(2 _y 0,0,0)' | (6) 2' _x x,0,0
(2 _x 0,0,0)' | (7) 2' _{xy} x,x,0
(2 _{xy} 0,0,0)' | (8) 2' _{xy} x,̄x,0
(2 _{xy} 0,0,0)' |
| (9) ̄1 0,0,0
(̄1 0,0,0)' | (10) m' _z x,y,0
(m _z 0,0,0)' | (11) ̄4 ⁺ 0,0,z; 0,0,0
(̄4 _z 0,0,0)' | (12) ̄4 ⁻ 0,0,z; 0,0,0
(̄4 _z ⁻¹ 0,0,0)' |
| (13) m _y x,0,z
(m _y 0,0,0) | (14) m _x 0,y,z
(m _x 0,0,0) | (15) m _{xy} x,̄x,z
(m _{xy} 0,0,0) | (16) m _{xy} x,x,z
(m _{xy} 0,0,0) |

Generators selected (1); t(0,0,1); (2); (3); (5); (9)

Positions

	Coordinates			
Multiplicity, Wyckoff letter, Site symmetry				
16 l 1	(1) x,y,z [u,v,w]	(2) \bar{x},\bar{y},z [\bar{u},\bar{v},w]	(3) \bar{y},x,z [\bar{v},u,w]	(4) y, \bar{x},z [v, \bar{u},w]
	(5) \bar{x},y,\bar{z} [\bar{u},\bar{v},w]	(6) x, \bar{y},\bar{z} [\bar{u},v,w]	(7) y,x, \bar{z} [\bar{v},\bar{u},w]	(8) \bar{y},\bar{x},\bar{z} [v,u,w]
	(9) \bar{x},\bar{y},\bar{z} [\bar{u},\bar{v},\bar{w}]	(10) x,y, \bar{z} [u,v, \bar{w}]	(11) y, \bar{x},\bar{z} [v, \bar{u},\bar{w}]	(12) \bar{y},x,\bar{z} [\bar{v},u,\bar{w}]
	(13) x, \bar{y},z [\bar{u},v,\bar{w}]	(14) \bar{x},y,z [u, \bar{v},\bar{w}]	(15) \bar{y},\bar{x},z [v,u, \bar{w}]	(16) y,x,z [\bar{v},\bar{u},\bar{w}]
8 k .m.	x,0,z [0,v,0]	$\bar{x},0,z$ [0, $\bar{v},0$]	0,x,z [$\bar{v},0,0$]	0, \bar{x},z [v,0,0]
	$\bar{x},0,\bar{z}$ [0, $\bar{v},0$]	x,0, \bar{z} [0,v,0]	0,x, \bar{z} [$\bar{v},0,0$]	0, \bar{x},\bar{z} [v,0,0]
8 j ..m	x,x,z [u, $\bar{u},0$]	\bar{x},\bar{x},z [$\bar{u},u,0$]	\bar{x},x,z [u,u,0]	x, \bar{x},z [$\bar{u},\bar{u},0$]
	\bar{x},x,\bar{z} [u,u,0]	x, \bar{x},\bar{z} [$\bar{u},\bar{u},0$]	x,x, \bar{z} [u, $\bar{u},0$]	\bar{x},\bar{x},\bar{z} [$\bar{u},u,0$]
8 i m'..	x,y,1/2 [u,v,0]	$\bar{x},\bar{y},1/2$ [$\bar{u},\bar{v},0$]	$\bar{y},x,1/2$ [$\bar{v},u,0$]	y, $\bar{x},1/2$ [v, $\bar{u},0$]
	$\bar{x},y,1/2$ [u, $\bar{v},0$]	x, $\bar{y},1/2$ [$\bar{u},v,0$]	y,x,1/2 [$\bar{v},\bar{u},0$]	$\bar{y},\bar{x},1/2$ [v,u,0]
8 h m'..	x,y,0 [u,v,0]	$\bar{x},\bar{y},0$ [$\bar{u},\bar{v},0$]	$\bar{y},x,0$ [$\bar{v},u,0$]	y, $\bar{x},0$ [v, $\bar{u},0$]
	$\bar{x},y,0$ [u, $\bar{v},0$]	x, $\bar{y},0$ [$\bar{u},v,0$]	y,x,0 [$\bar{v},\bar{u},0$]	$\bar{y},\bar{x},0$ [v,u,0]
4 g m'2'm.	x,0,1/2 [0,v,0]	$\bar{x},0,1/2$ [0, $\bar{v},0$]	0,x,1/2 [$\bar{v},0,0$]	0, $\bar{x},1/2$ [v,0,0]
4 f m'2'm.	x,0,0 [0,v,0]	$\bar{x},0,0$ [0, $\bar{v},0$]	0,x,0 [$\bar{v},0,0$]	0, $\bar{x},0$ [v,0,0]
4 e m'.2'm	x,x,1/2 [u, $\bar{u},0$]	$\bar{x},\bar{x},1/2$ [$\bar{u},u,0$]	$\bar{x},x,1/2$ [u,u,0]	x, $\bar{x},1/2$ [$\bar{u},\bar{u},0$]
4 d m'.2'm	x,x,0 [u, $\bar{u},0$]	$\bar{x},\bar{x},0$ [$\bar{u},u,0$]	$\bar{x},x,0$ [u,u,0]	x, $\bar{x},0$ [$\bar{u},\bar{u},0$]

Continued

No. 39.5.204

$p4/m'mm$

2 c 4mm $0,0,z [0,0,0]$ $0,0,\bar{z} [0,0,0]$

1 b $4/m'mm$ $0,0,1/2 [0,0,0]$

1 a $4/m'mm$ $0,0,0 [0,0,0]$

Symmetry of special projections

Along $[001]$ 4mm	Along $[100]$ $p2mm1'$	Along $[110]$ $p2mm1'$
	$a^* = c$	$a^* = c$
Origin at $0,0,z$	Origin at $x,0,0$	Origin at $x,x,0$

$p4'/m'm'm$

$4'/m'm'm$

Tetragonal

No. 39.6.205

$p4'/m'2'/m'2'/m$

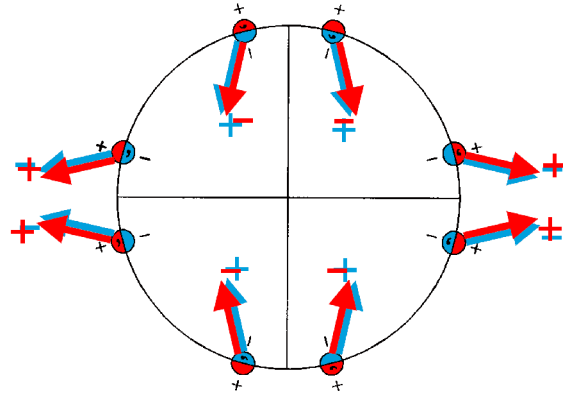
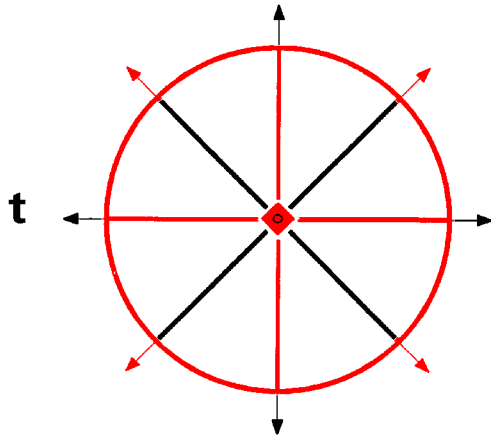

Origin at center ($4'/m'm'm$)

Asymmetric unit $0 \leq x; 0 \leq y; 0 \leq z \leq 1/2; x \leq y$

Symmetry operations

- | | | | |
|---|---|--|--|
| (1) 1
(1 0,0,0) | (2) 2 0,0,z
(2 _z 0,0,0) | (3) 4 ⁺ 0,0,z
(4 _z 0,0,0)' | (4) 4 ⁻ 0,0,z
(4 _z ⁻¹ 0,0,0)' |
| (5) 2 0,y,0
(2 _y 0,0,0) | (6) 2 x,0,0
(2 _x 0,0,0) | (7) 2' x,x,0
(2 _{xy} 0,0,0)' | (8) 2' x,x̄,0
(2 _{xy} 0,0,0)' |
| (9) $\bar{1}$ 0,0,0
($\bar{1}$ 0,0,0)' | (10) m' x,y,0
(m _z 0,0,0)' | (11) $\bar{4}$ ⁺ 0,0,z; 0,0,0
($\bar{4}$ _z 0,0,0) | (12) $\bar{4}$ ⁻ 0,0,z; 0,0,0
($\bar{4}$ _z ⁻¹ 0,0,0) |
| (13) m' x,0,z
(m _y 0,0,0)' | (14) m' 0,y,z
(m _x 0,0,0)' | (15) m x,x̄,z
(m _{xy} 0,0,0) | (16) m x,x,z
(m _{xy} 0,0,0) |

Generators selected (1); t(0,0,1); (2); (3); (5); (9)

Positions

	Coordinates			
Multiplicity, Wyckoff letter, Site symmetry				
16 l 1	(1) x,y,z [u,v,w]	(2) \bar{x},\bar{y},z [\bar{u},\bar{v},w]	(3) \bar{y},x,z [v,\bar{u},\bar{w}]	(4) y, \bar{x},z [\bar{v},u,\bar{w}]
	(5) \bar{x},y,\bar{z} [\bar{u},v,\bar{w}]	(6) x, \bar{y},\bar{z} [u,\bar{v},\bar{w}]	(7) y,x, \bar{z} [\bar{v},\bar{u},w]	(8) \bar{y},\bar{x},\bar{z} [v,u,w]
	(9) \bar{x},\bar{y},\bar{z} [\bar{u},\bar{v},\bar{w}]	(10) x,y, \bar{z} [u,v,\bar{w}]	(11) y, \bar{x},\bar{z} [\bar{v},u,w]	(12) \bar{y},x,\bar{z} [v,\bar{u},w]
	(13) x, \bar{y},z [u,\bar{v},w]	(14) \bar{x},y,z [\bar{u},v,w]	(15) \bar{y},\bar{x},z [v,u,\bar{w}]	(16) y,x,z [\bar{v},\bar{u},\bar{w}]
8 k .m'	x,0,z [u,0,w]	$\bar{x},0,z$ [$\bar{u},0,w$]	0,x,z [0, \bar{u},\bar{w}]	0, \bar{x},z [0,u, \bar{w}]
	$\bar{x},0,\bar{z}$ [$\bar{u},0,\bar{w}$]	x,0, \bar{z} [u,0, \bar{w}]	0,x, \bar{z} [0, \bar{u},w]	0, \bar{x},\bar{z} [0,u,w]
8 j ..m	x,x,z [u, $\bar{u},0$]	\bar{x},\bar{x},z [$\bar{u},u,0$]	\bar{x},x,z [$\bar{u},\bar{u},0$]	x, \bar{x},z [u,u,0]
	\bar{x},x,\bar{z} [$\bar{u},\bar{u},0$]	x, \bar{x},\bar{z} [u,u,0]	x,x, \bar{z} [u, $\bar{u},0$]	\bar{x},\bar{x},\bar{z} [$\bar{u},u,0$]
8 i m'..	x,y,1/2 [u,v,0]	$\bar{x},\bar{y},1/2$ [$\bar{u},\bar{v},0$]	$\bar{y},x,1/2$ [$v,\bar{u},0$]	y, $\bar{x},1/2$ [$\bar{v},u,0$]
	$\bar{x},y,1/2$ [$\bar{u},v,0$]	x, $\bar{y},1/2$ [$u,\bar{v},0$]	y,x,1/2 [$\bar{v},\bar{u},0$]	$\bar{y},\bar{x},1/2$ [$v,u,0$]
8 h m'..	x,y,0 [u,v,0]	$\bar{x},\bar{y},0$ [$\bar{u},\bar{v},0$]	$\bar{y},x,0$ [$v,\bar{u},0$]	y, $\bar{x},0$ [$\bar{v},u,0$]
	$\bar{x},y,0$ [$\bar{u},v,0$]	x, $\bar{y},0$ [$u,\bar{v},0$]	y,x,0 [$\bar{v},\bar{u},0$]	$\bar{y},\bar{x},0$ [$v,u,0$]
4 g m'2m'	x,0,1/2 [u,0,0]	$\bar{x},0,1/2$ [$\bar{u},0,0$]	0,x,1/2 [0, $\bar{u},0$]	0, $\bar{x},1/2$ [0,u,0]
4 f m'2m'	x,0,0 [u,0,0]	$\bar{x},0,0$ [$\bar{u},0,0$]	0,x,0 [0, $\bar{u},0$]	0, $\bar{x},0$ [0,u,0]
4 e m'.2'm	x,x,1/2 [u, $\bar{u},0$]	$\bar{x},\bar{x},1/2$ [$\bar{u},u,0$]	$\bar{x},x,1/2$ [$\bar{u},\bar{u},0$]	x, $\bar{x},1/2$ [u,u,0]
4 d m'.2'm	x,x,0 [u, $\bar{u},0$]	$\bar{x},\bar{x},0$ [$\bar{u},u,0$]	$\bar{x},x,0$ [$\bar{u},\bar{u},0$]	x, $\bar{x},0$ [u,u,0]

Continued

No. 39.6.205

$p4'/m'm'm$

2 c $4'm'm$ $0,0,z [0,0,0]$ $0,0,\bar{z} [0,0,0]$

1 b $4'/m'm'm$ $0,0,1/2 [0,0,0]$

1 a $4'/m'm'm$ $0,0,0 [0,0,0]$

Symmetry of special projections

Along $[001]$ $4'm'm$	Along $[100]$ $p2m'm'$ $a^* = c$	Along $[110]$ $p2mm1'$ $a^* = c$
Origin at $0,0,z$	Origin at $x,0,0$	Origin at $x,x,0$

$p4'/mmm'$

No. 39.7.206

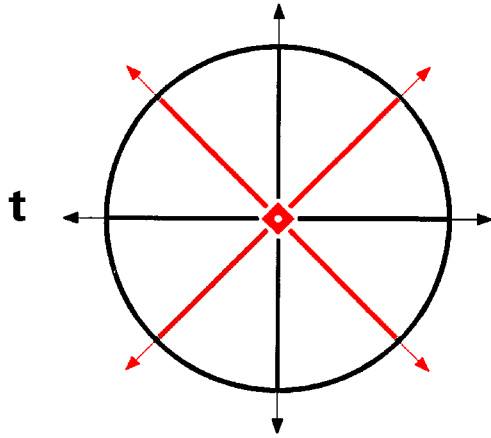

$4'/mmm'$

$p4'/m2/m2'/m'$

Tetragonal

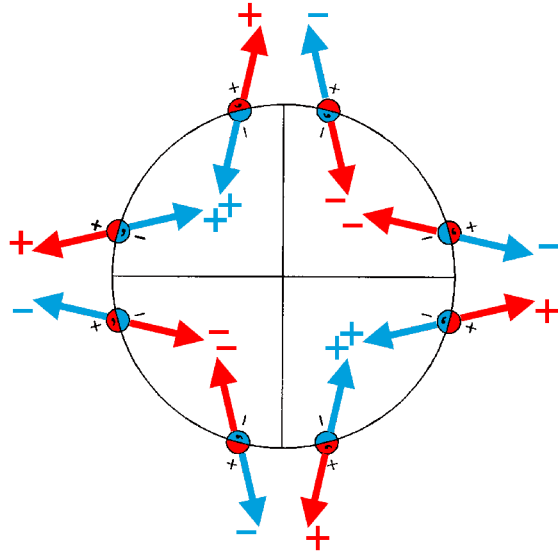

Origin at center ($4'/mmm'$)

Asymmetric unit $0 \leq x$; $0 \leq y$; $0 \leq z \leq 1/2$; $x \leq y$

Symmetry operations

- | | | | |
|--|---|--|--|
| (1) 1
(1 0,0,0) | (2) 2 0,0,z
(2 _z 0,0,0) | (3) 4 ⁺ 0,0,z
(4 _z ⁺ 0,0,0)' | (4) 4 ⁻ 0,0,z
(4 _z ⁻ 0,0,0)' |
| (5) 2 0,y,0
(2 _y 0,0,0) | (6) 2 x,0,0
(2 _x 0,0,0) | (7) 2' x,x,0
(2 _{xy} 0,0,0)' | (8) 2' x,̄x,0
(2 _{̄xy} 0,0,0)' |
| (9) $\bar{1}$ 0,0,0
($\bar{1}$ 0,0,0) | (10) m x,y,0
(m _z 0,0,0) | (11) $\bar{4}$ ⁺ 0,0,z; 0,0,0
($\bar{4}$ _z ⁺ 0,0,0)' | (12) $\bar{4}$ ⁻ 0,0,z; 0,0,0
($\bar{4}$ _z ⁻ 0,0,0)' |
| (13) m x,0,z
(m _y 0,0,0) | (14) m 0,y,z
(m _x 0,0,0) | (15) m' x,̄x,z
(m _{xy} 0,0,0)' | (16) m' x,x,z
(m _{̄xy} 0,0,0)' |

Generators selected (1); t(0,0,1); (2); (3); (5); (9)

Positions

	Coordinates			
Multiplicity, Wyckoff letter, Site symmetry				
16 l 1	(1) x,y,z [u,v,w]	(2) \bar{x},\bar{y},z [\bar{u},\bar{v},w]	(3) \bar{y},x,z [v,\bar{u},\bar{w}]	(4) y, \bar{x},z [\bar{v},u,\bar{w}]
	(5) \bar{x},y,\bar{z} [\bar{u},v,\bar{w}]	(6) x, \bar{y},\bar{z} [u,\bar{v},\bar{w}]	(7) y,x, \bar{z} [\bar{v},\bar{u},w]	(8) \bar{y},\bar{x},\bar{z} [v,u,w]
	(9) \bar{x},\bar{y},\bar{z} [u,v,w]	(10) x,y, \bar{z} [\bar{u},\bar{v},w]	(11) y, \bar{x},\bar{z} [v,\bar{u},\bar{w}]	(12) \bar{y},x,\bar{z} [\bar{v},u,\bar{w}]
	(13) x, \bar{y},z [\bar{u},v,\bar{w}]	(14) \bar{x},y,z [u,\bar{v},\bar{w}]	(15) \bar{y},\bar{x},z [\bar{v},\bar{u},w]	(16) y,x,z [v,u,w]
8 k .m.	x,0,z [0,v,0]	$\bar{x},0,z$ [0, \bar{v} ,0]	0,x,z [v,0,0]	0, \bar{x},z [\bar{v} ,0,0]
	$\bar{x},0,\bar{z}$ [0,v,0]	x,0, \bar{z} [0, \bar{v} ,0]	0,x, \bar{z} [\bar{v} ,0,0]	0, \bar{x},\bar{z} [v,0,0]
8 j ..m'	x,x,z [u,u,w]	\bar{x},\bar{x},z [\bar{u},\bar{u},w]	\bar{x},x,z [u, \bar{u},\bar{w}]	x, \bar{x},z [\bar{u},u,\bar{w}]
	\bar{x},x,\bar{z} [\bar{u},u,\bar{w}]	x, \bar{x},\bar{z} [u, \bar{u},\bar{w}]	x,x, \bar{z} [\bar{u},\bar{u},w]	\bar{x},\bar{x},\bar{z} [u,u,w]
8 i m..	x,y,1/2 [0,0,w]	$\bar{x},\bar{y},1/2$ [0,0,w]	$\bar{y},x,1/2$ [0,0, \bar{w}]	y, $\bar{x},1/2$ [0,0, \bar{w}]
	$\bar{x},y,1/2$ [0,0, \bar{w}]	x, $\bar{y},1/2$ [0,0, \bar{w}]	y,x,1/2 [0,0,w]	$\bar{y},\bar{x},1/2$ [0,0,w]
8 h m..	x,y,0 [0,0,w]	$\bar{x},\bar{y},0$ [0,0,w]	$\bar{y},x,0$ [0,0, \bar{w}]	y, $\bar{x},0$ [0,0, \bar{w}]
	$\bar{x},y,0$ [0,0, \bar{w}]	x, $\bar{y},0$ [0,0, \bar{w}]	y,x,0 [0,0,w]	$\bar{y},\bar{x},0$ [0,0,w]
4 g m2m.	x,0,1/2 [0,0,0]	$\bar{x},0,1/2$ [0,0,0]	0,x,1/2 [0,0,0]	0, $\bar{x},1/2$ [0,0,0]
4 f m2m.	x,0,0 [0,0,0]	$\bar{x},0,0$ [0,0,0]	0,x,0 [0,0,0]	0, $\bar{x},0$ [0,0,0]
4 e m.2'm'	x,x,1/2 [0,0,w]	$\bar{x},\bar{x},1/2$ [0,0,w]	$\bar{x},x,1/2$ [0,0, \bar{w}]	x, $\bar{x},1/2$ [0,0, \bar{w}]
4 d m.2'm'	x,x,0 [0,0,w]	$\bar{x},\bar{x},0$ [0,0,w]	$\bar{x},x,0$ [0,0, \bar{w}]	x, $\bar{x},0$ [0,0, \bar{w}]

Continued

No. 39.7.206

$p4'/mmm'$

2 c $4'mm'$ $0,0,z [0,0,0]$ $0,0,\bar{z} [0,0,0]$

1 b $4'/mmm'$ $0,0,1/2 [0,0,0]$

1 a $4'/mmm'$ $0,0,0 [0,0,0]$

Symmetry of special projections

Along $[001]$ $4mm1'$	Along $[100]$ $p2mm1'$	Along $[110]$ $p2'mm'$
Origin at $0,0,z$	$a^* = c$ Origin at $x,0,0$	$a^* = c$ Origin at $x,x,0$

$p_{2c}4/mm'm'$

$4/mmm1'$

Tetragonal

No. 39.8.207

$p_{2c}4/m2'/m2'/m'$

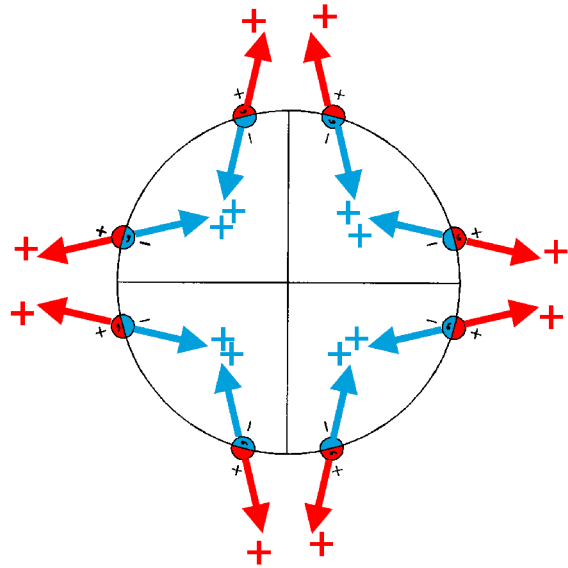
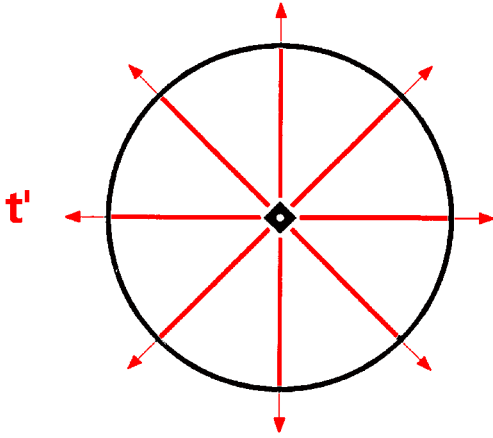

Origin at center ($4/mmm'$)

Asymmetric unit $0 \leq x; 0 \leq y; 0 \leq z \leq 1/2; x \leq y$

Symmetry operations

For $(0,0,0)$ + set

- | | | | |
|--|---|--|--|
| (1) 1
(1 0,0,0) | (2) 2 _z 0,0,z
(2 _z 0,0,0) | (3) 4 ⁺ 0,0,z
(4 _z 0,0,0) | (4) 4 ⁻ 0,0,z
(4 _z ⁻¹ 0,0,0) |
| (5) 2' 0,y,0
(2 _y 0,0,0)' | (6) 2' x,0,0
(2 _x 0,0,0)' | (7) 2' x,x,0
(2 _{xy} 0,0,0)' | (8) 2' x, \bar{x} ,0
(2 _{xy} 0,0,0)' |
| (9) $\bar{1}$ 0,0,0
($\bar{1}$ 0,0,0) | (10) m x,y,0
(m _z 0,0,0) | (11) $\bar{4}$ ⁺ 0,0,z; 0,0,0
($\bar{4}$ _z 0,0,0) | (12) $\bar{4}$ ⁻ 0,0,z; 0,0,0
($\bar{4}$ _z ⁻¹ 0,0,0) |
| (13) m' x,0,z
(m _y 0,0,0)' | (14) m' 0,y,z
(m _x 0,0,0)' | (15) m' x, \bar{x} ,z
(m _{xy} 0,0,0)' | (16) m' x,x,z
(m _{xy} 0,0,0)' |

For $(0,0,1)$ ' + set

- | | | | |
|---|--|---|---|
| (1) t' (0,0,1)
(1 0,0,1)' | (2) 2' (0,0,1) 0,0,z
(2 _z 0,0,1)' | (3) 4 ⁺ ' (0,0,1) 0,0,z
(4 _z 0,0,1)' | (4) 4 ⁻ ' (0,0,1) 0,0,z
(4 _z ⁻¹ 0,0,1)' |
| (5) 2 0,y,1/2
(2 _y 0,0,1) | (6) 2 x,0,1/2
(2 _x 0,0,1) | (7) 2 x,x,1/2
(2 _{xy} 0,0,1) | (8) 2 x, \bar{x} ,1/2
(2 _{xy} 0,0,1) |
| (9) $\bar{1}$ ' 0,0,1/2
($\bar{1}$ 0,0,1)' | (10) m' x,y,1/2
(m _z 0,0,1)' | (11) $\bar{4}$ ⁺ ' 0,0,z; 0,0,1/2
($\bar{4}$ _z 0,0,1)' | (12) $\bar{4}$ ⁻ ' 0,0,z; 0,0,1/2
($\bar{4}$ _z ⁻¹ 0,0,1)' |
| (13) c (0,0,1) x,0,z
(m _y 0,0,1) | (14) c (0,0,1) 0,y,z
(m _x 0,0,1) | (15) c (0,0,1) x, \bar{x} ,z
(m _{xy} 0,0,1) | (16) c (0,0,1) x,x,z
(m _{xy} 0,0,1) |

Generators selected (1); $t(0,0,1)'$; (2); (3); (5); (9)

Positions

Multiplicity, Wyckoff letter, Site symmetry	Coordinates			
		(0,0,0)+	(0,0,1)'	+
16 l 1	(1) $x,y,z [u,v,w]$	(2) $\bar{x},\bar{y},z [\bar{u},\bar{v},w]$	(3) $\bar{y},x,z [\bar{v},u,w]$	(4) $y,\bar{x},z [v,\bar{u},w]$
	(5) $\bar{x},y,\bar{z} [u,\bar{v},w]$	(6) $x,\bar{y},\bar{z} [\bar{u},v,w]$	(7) $y,x,\bar{z} [\bar{v},\bar{u},w]$	(8) $\bar{y},\bar{x},\bar{z} [v,u,w]$
	(9) $\bar{x},\bar{y},\bar{z} [u,v,w]$	(10) $x,y,\bar{z} [\bar{u},\bar{v},w]$	(11) $y,\bar{x},\bar{z} [\bar{v},u,w]$	(12) $\bar{y},x,\bar{z} [v,\bar{u},w]$
	(13) $x,\bar{y},z [u,\bar{v},w]$	(14) $\bar{x},y,z [\bar{u},v,w]$	(15) $\bar{y},\bar{x},z [\bar{v},\bar{u},w]$	(16) $y,x,z [v,u,w]$
8 k .m'	$x,0,z [u,0,w]$	$\bar{x},0,z [\bar{u},0,w]$	$0,x,z [0,u,w]$	$0,\bar{x},z [0,\bar{u},w]$
	$\bar{x},0,\bar{z} [u,0,w]$	$x,0,\bar{z} [\bar{u},0,w]$	$0,x,\bar{z} [0,\bar{u},w]$	$0,\bar{x},\bar{z} [0,u,w]$
8 j ..m'	$x,x,z [u,u,w]$	$\bar{x},\bar{x},z [\bar{u},\bar{u},w]$	$\bar{x},x,z [\bar{u},u,w]$	$x,\bar{x},z [u,\bar{u},w]$
	$\bar{x},x,\bar{z} [u,\bar{u},w]$	$x,\bar{x},\bar{z} [\bar{u},u,w]$	$x,x,\bar{z} [\bar{u},\bar{u},w]$	$\bar{x},\bar{x},\bar{z} [u,u,w]$
8 i m'..	$x,y,1/2 [u,v,0]$	$\bar{x},\bar{y},1/2 [\bar{u},\bar{v},0]$	$\bar{y},x,1/2 [\bar{v},u,0]$	$y,\bar{x},1/2 [v,\bar{u},0]$
	$\bar{x},y,1/2 [u,\bar{v},0]$	$x,\bar{y},1/2 [\bar{u},v,0]$	$y,x,1/2 [\bar{v},\bar{u},0]$	$\bar{y},\bar{x},1/2 [v,u,0]$
8 h m..	$x,y,0 [0,0,w]$	$\bar{x},\bar{y},0 [0,0,w]$	$\bar{y},x,0 [0,0,w]$	$y,\bar{x},0 [0,0,w]$
	$\bar{x},y,0 [0,0,w]$	$x,\bar{y},0 [0,0,w]$	$y,x,0 [0,0,w]$	$\bar{y},\bar{x},0 [0,0,w]$
4 g m'2m'	$x,0,1/2 [u,0,0]$	$\bar{x},0,1/2 [\bar{u},0,0]$	$0,x,1/2 [0,u,0]$	$0,\bar{x},1/2 [0,\bar{u},0]$
4 f m2'm'	$x,0,0 [0,0,w]$	$\bar{x},0,0 [0,0,w]$	$0,x,0 [0,0,w]$	$0,\bar{x},0 [0,0,w]$
4 e m'.2m'	$x,x,1/2 [u,u,0]$	$\bar{x},\bar{x},1/2 [\bar{u},\bar{u},0]$	$\bar{x},x,1/2 [\bar{u},u,0]$	$x,\bar{x},1/2 [u,\bar{u},0]$
4 d m.2'm'	$x,x,0 [0,0,w]$	$\bar{x},\bar{x},0 [0,0,w]$	$\bar{x},x,0 [0,0,w]$	$x,\bar{x},0 [0,0,w]$

Continued

No. 39.8.207

p_{2c} 4/mm'm'

2 c 4m'm' 0,0,z [0,0,w] 0,0, \bar{z} [0,0,w]

1 b 4/m'm'm' 0,0,1/2 [0,0,0]

1 a 4/mm'm' 0,0,0 [0,0,w]

Symmetry of special projections

Along [001] 4mm1'	Along [100] p_{2a^*} 2'mm'	Along [110] p_{2a^*} 2'mm'
	$a^* = c$	$a^* = c$
Origin at 0,0,z	Origin at x,0,0	Origin at x,x,0

$p_{2c}4'/mmm'$

$4/mmm1'$

Tetragonal

No. 39.9.208

$p_{2c}4'/m2/m2'/m'$

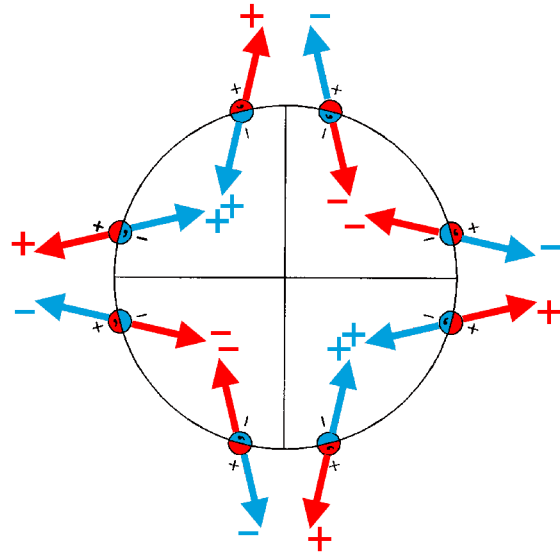
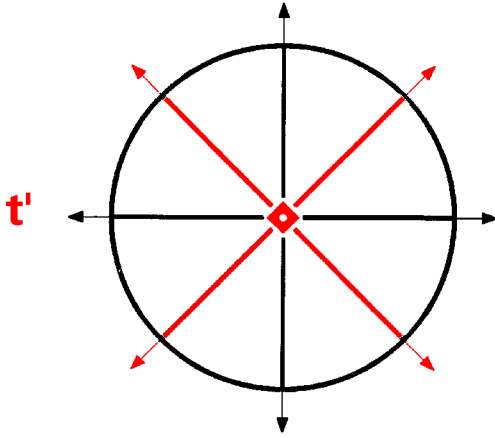

Origin at center ($4'/mmm'$)

Asymmetric unit $0 \leq x; 0 \leq y; 0 \leq z \leq 1/2; x \leq y$

Symmetry operations

For (0,0,0) + set

- | | | | |
|---|---|--|--|
| (1) 1
(1 0,0,0) | (2) 2 0,0,z
(2 _z 0,0,0) | (3) 4 ⁺ 0,0,z
(4 _z 0,0,0)' | (4) 4 ⁻ 0,0,z
(4 _z ⁻¹ 0,0,0)' |
| (5) 2 0,y,0
(2 _y 0,0,0) | (6) 2 x,0,0
(2 _x 0,0,0) | (7) 2' x,x,0
(2 _{xy} 0,0,0)' | (8) 2' x,x̄,0
(2 _{xy} 0,0,0)' |
| (9) 1̄ 0,0,0
(1̄ 0,0,0) | (10) m x,y,0
(m _z 0,0,0) | (11) 4̄ ⁺ 0,0,z; 0,0,0
(4̄ _z 0,0,0)' | (12) 4̄ ⁻ 0,0,z; 0,0,0
(4̄ _z ⁻¹ 0,0,0)' |
| (13) m x,0,z
(m _y 0,0,0) | (14) m 0,y,z
(m _x 0,0,0) | (15) m' x,x̄,z
(m _{xy} 0,0,0)' | (16) m' x,x,z
(m _{xy} 0,0,0)' |

For (0,0,1)' + set

- | | | | |
|---|---|---|---|
| (1) t' (0,0,1)
(1 0,0,1)' | (2) 2' (0,0,1) 0,0,z
(2 _z 0,0,1)' | (3) 4 ⁺ (0,0,1) 0,0,z
(4 _z 0,0,1) | (4) 4 ⁻ (0,0,1) 0,0,z
(4 _z ⁻¹ 0,0,1) |
| (5) 2' 0,y,1/2
(2 _y 0,0,1)' | (6) 2' x,0,1/2
(2 _x 0,0,1)' | (7) 2 x,x,1/2
(2 _{xy} 0,0,1) | (8) 2 x,x̄,1/2
(2 _{xy} 0,0,1) |
| (9) 1̄' 0,0,1/2
(1̄' 0,0,1)' | (10) m' x,y,1/2
(m _z 0,0,1)' | (11) 4̄ ⁺ 0,0,z; 0,0,1/2
(4̄ _z 0,0,1) | (12) 4̄ ⁻ 0,0,z; 0,0,1/2
(4̄ _z ⁻¹ 0,0,1) |
| (13) c' (0,0,1) x,0,z
(m _y 0,0,1)' | (14) c' (0,0,1) 0,y,z
(m _x 0,0,1)' | (15) c (0,0,1) x,x̄,z
(m _{xy} 0,0,1) | (16) c (0,0,1) x,x,z
(m _{xy} 0,0,1) |

Generators selected (1); $t(0,0,1)'$; (2); (3); (5); (9)

Positions

Multiplicity, Wyckoff letter, Site symmetry	Coordinates			
		(0,0,0)+	(0,0,1)' +	
16 l 1	(1) $x,y,z [u,v,w]$	(2) $\bar{x},\bar{y},z [\bar{u},\bar{v},w]$	(3) $\bar{y},x,z [v,\bar{u},\bar{w}]$	(4) $y,\bar{x},z [\bar{v},u,\bar{w}]$
	(5) $\bar{x},y,\bar{z} [\bar{u},v,\bar{w}]$	(6) $x,\bar{y},\bar{z} [u,\bar{v},\bar{w}]$	(7) $y,x,\bar{z} [\bar{v},\bar{u},w]$	(8) $\bar{y},\bar{x},\bar{z} [v,u,w]$
	(9) $\bar{x},\bar{y},z [u,v,w]$	(10) $x,y,\bar{z} [\bar{u},\bar{v},w]$	(11) $y,\bar{x},\bar{z} [v,\bar{u},\bar{w}]$	(12) $\bar{y},x,\bar{z} [\bar{v},u,\bar{w}]$
	(13) $x,\bar{y},z [\bar{u},v,\bar{w}]$	(14) $\bar{x},y,z [u,\bar{v},\bar{w}]$	(15) $\bar{y},\bar{x},z [\bar{v},\bar{u},w]$	(16) $y,x,z [v,u,w]$
8 k .m.	$x,0,z [0,v,0]$	$\bar{x},0,z [0,\bar{v},0]$	$0,x,z [v,0,0]$	$0,\bar{x},z [\bar{v},0,0]$
	$\bar{x},0,\bar{z} [0,v,0]$	$x,0,\bar{z} [0,\bar{v},0]$	$0,x,\bar{z} [\bar{v},0,0]$	$0,\bar{x},\bar{z} [v,0,0]$
8 j ..m'	$x,x,z [u,u,w]$	$\bar{x},\bar{x},z [\bar{u},\bar{u},w]$	$\bar{x},x,z [u,\bar{u},\bar{w}]$	$x,\bar{x},z [\bar{u},u,\bar{w}]$
	$\bar{x},x,\bar{z} [\bar{u},u,\bar{w}]$	$x,\bar{x},\bar{z} [u,\bar{u},\bar{w}]$	$x,x,\bar{z} [\bar{u},\bar{u},w]$	$\bar{x},\bar{x},\bar{z} [u,u,w]$
8 i m'..	$x,y,1/2 [u,v,0]$	$\bar{x},\bar{y},1/2 [\bar{u},\bar{v},0]$	$\bar{y},x,1/2 [v,\bar{u},0]$	$y,\bar{x},1/2 [\bar{v},u,0]$
	$\bar{x},y,1/2 [\bar{u},v,0]$	$x,\bar{y},1/2 [u,\bar{v},0]$	$y,x,1/2 [\bar{v},\bar{u},0]$	$\bar{y},\bar{x},1/2 [v,u,0]$
8 h m..	$x,y,0 [0,0,w]$	$\bar{x},\bar{y},0 [0,0,w]$	$\bar{y},x,0 [0,0,\bar{w}]$	$y,\bar{x},0 [0,0,\bar{w}]$
	$\bar{x},y,0 [0,0,\bar{w}]$	$x,\bar{y},0 [0,0,\bar{w}]$	$y,x,0 [0,0,w]$	$\bar{y},\bar{x},0 [0,0,w]$
4 g m'2'm.	$x,0,1/2 [0,v,0]$	$\bar{x},0,1/2 [0,\bar{v},0]$	$0,x,1/2 [v,0,0]$	$0,\bar{x},1/2 [\bar{v},0,0]$
4 f m2m.	$x,0,0 [0,0,0]$	$\bar{x},0,0 [0,0,0]$	$0,x,0 [0,0,0]$	$0,\bar{x},0 [0,0,0]$
4 e m'.2m'	$x,x,1/2 [u,u,0]$	$\bar{x},\bar{x},1/2 [\bar{u},\bar{u},0]$	$\bar{x},x,1/2 [u,\bar{u},0]$	$x,\bar{x},1/2 [\bar{u},u,0]$
4 d m.2'm'	$x,x,0 [0,0,w]$	$\bar{x},\bar{x},0 [0,0,w]$	$\bar{x},x,0 [0,0,\bar{w}]$	$x,\bar{x},0 [0,0,\bar{w}]$

Continued

No. 39.9.208

$p_{2c} 4'/mmm'$

2 c $4'mm'$ $0,0,z [0,0,0]$ $0,0,\bar{z} [0,0,0]$

1 b $4'/m'mm'$ $0,0,1/2 [0,0,0]$

1 a $4'/mmm'$ $0,0,0 [0,0,0]$

Symmetry of special projections

Along $[001] 4mm1'$	Along $[100] p2mm1'$	Along $[110] p_{2a^*} 2'mm'$
Origin at $0,0,z$	$a^* = c$ Origin at $x,0,0$	$a^* = c$ Origin at $x,x,0$

$p_{2c}4/mmm$

$4/mmm1'$

Tetragonal

No. 39.10.209

$p_{2c}4/m2/m2/m$

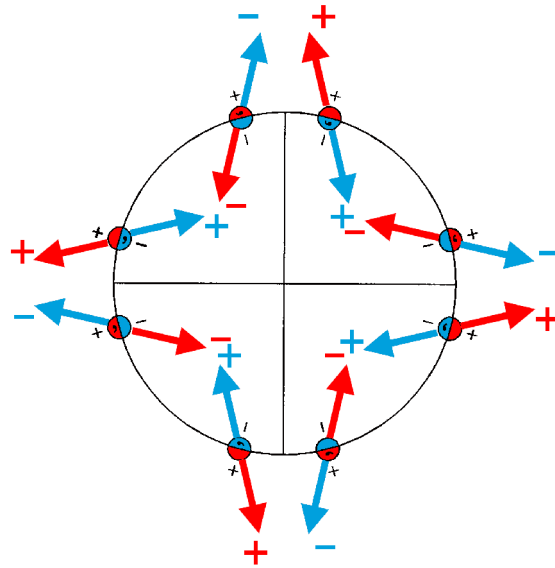
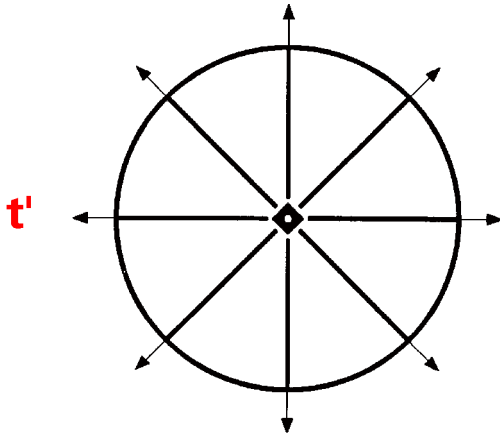

Origin at center ($4/mmm$)

Asymmetric unit $0 \leq x; 0 \leq y; 0 \leq z \leq 1/2; x \leq y$

Symmetry operations

- | | | | |
|--|---|--|---|
| (1) 1
(1 0,0,0) | (2) 2 0,0,z
(2 _z 0,0,0) | (3) 4 ⁺ 0,0,z
(4 _z 0,0,0) | (4) 4 ⁻ 0,0,z
(4 _z ⁻¹ 0,0,0) |
| (5) 2 0,y,0
(2 _y 0,0,0) | (6) 2 x,0,0
(2 _x 0,0,0) | (7) 2 x,x,0
(2 _{xy} 0,0,0) | (8) 2 x,x̄,0
(2 _{xy} 0,0,0) |
| (9) $\bar{1}$ 0,0,0
($\bar{1}$ 0,0,0) | (10) m x,y,0
(m _z 0,0,0) | (11) $\bar{4}^+$ 0,0,z; 0,0,0
($\bar{4}_z$ 0,0,0) | (12) $\bar{4}^-$ 0,0,z; 0,0,0
($\bar{4}_z^{-1}$ 0,0,0) |
| (13) m x,0,z
(m _y 0,0,0) | (14) m 0,y,z
(m _x 0,0,0) | (15) m x,x̄,z
(m _{xy} 0,0,0) | (16) m x,x,z
(m _{xy} 0,0,0) |

For (0,0,1)' + set

- | | | | |
|---|---|--|--|
| (1) t' (0,0,1)
(1 0,0,1)' | (2) 2' (0,0,1) 0,0,z
(2 _z 0,0,1)' | (3) 4 ⁺ ' (0,0,1) 0,0,z
(4 _z 0,0,1)' | (4) 4 ⁻ ' (0,0,1) 0,0,z
(4 _z ⁻¹ 0,0,1)' |
| (5) 2' 0,y,1/2
(2 _y 0,0,1)' | (6) 2' x,0,1/2
(2 _x 0,0,1)' | (7) 2' x,x,1/2
(2 _{xy} 0,0,1)' | (8) 2' x,x̄,1/2
(2 _{xy} 0,0,1)' |
| (9) $\bar{1}$ ' 0,0,1/2
($\bar{1}$ 0,0,1)' | (10) m' x,y,1/2
(m _z 0,0,1)' | (11) $\bar{4}^+$ ' 0,0,z; 0,0,1/2
($\bar{4}_z$ 0,0,1)' | (12) $\bar{4}^-$ ' 0,0,z; 0,0,1/2
($\bar{4}_z^{-1}$ 0,0,1)' |
| (13) c' (0,0,1) x,0,z
(m _y 0,0,1)' | (14) c' (0,0,1) 0,y,z
(m _x 0,0,1)' | (15) c' (0,0,1) x,x̄,z
(m _{xy} 0,0,1)' | (16) c' (0,0,1) x,x,z
(m _{xy} 0,0,1)' |

Generators selected (1); $t(0,0,1)'$; (2); (3); (5); (9)

Positions

Multiplicity, Wyckoff letter, Site symmetry	Coordinates			
		(0,0,0)+	(0,0,1)'	+
16 l 1	(1) $x,y,z [u,v,w]$	(2) $\bar{x},\bar{y},z [\bar{u},\bar{v},w]$	(3) $\bar{y},x,z [\bar{v},u,w]$	(4) $y,\bar{x},z [v,\bar{u},w]$
	(5) $\bar{x},y,\bar{z} [\bar{u},v,\bar{w}]$	(6) $x,\bar{y},\bar{z} [u,\bar{v},\bar{w}]$	(7) $y,x,\bar{z} [v,u,\bar{w}]$	(8) $\bar{y},\bar{x},\bar{z} [\bar{v},\bar{u},\bar{w}]$
	(9) $\bar{x},\bar{y},z [u,v,w]$	(10) $x,y,\bar{z} [\bar{u},\bar{v},w]$	(11) $y,\bar{x},z [\bar{v},u,w]$	(12) $\bar{y},x,\bar{z} [v,\bar{u},w]$
	(13) $x,\bar{y},z [\bar{u},v,\bar{w}]$	(14) $\bar{x},y,z [u,\bar{v},\bar{w}]$	(15) $\bar{y},\bar{x},z [v,u,\bar{w}]$	(16) $y,x,z [v,\bar{u},\bar{w}]$
8 k .m.	$x,0,z [0,v,0]$	$\bar{x},0,z [0,\bar{v},0]$	$0,x,z [\bar{v},0,0]$	$0,\bar{x},z [v,0,0]$
	$\bar{x},0,\bar{z} [0,v,0]$	$x,0,\bar{z} [0,\bar{v},0]$	$0,x,\bar{z} [v,0,0]$	$0,\bar{x},\bar{z} [\bar{v},0,0]$
8 j ..m	$x,x,z [u,\bar{u},0]$	$\bar{x},\bar{x},z [\bar{u},u,0]$	$\bar{x},x,z [u,u,0]$	$x,\bar{x},z [\bar{u},\bar{u},0]$
	$\bar{x},x,\bar{z} [\bar{u},\bar{u},0]$	$x,\bar{x},\bar{z} [u,u,0]$	$x,x,\bar{z} [\bar{u},u,0]$	$\bar{x},\bar{x},\bar{z} [u,\bar{u},0]$
8 i m'..	$x,y,1/2 [u,v,0]$	$\bar{x},\bar{y},1/2 [\bar{u},\bar{v},0]$	$\bar{y},x,1/2 [\bar{v},u,0]$	$y,\bar{x},1/2 [v,\bar{u},0]$
	$\bar{x},y,1/2 [\bar{u},v,0]$	$x,\bar{y},1/2 [u,\bar{v},0]$	$y,x,1/2 [v,u,0]$	$\bar{y},\bar{x},1/2 [\bar{v},\bar{u},0]$
8 h m..	$x,y,0 [0,0,w]$	$\bar{x},\bar{y},0 [0,0,w]$	$\bar{y},x,0 [0,0,w]$	$y,\bar{x},0 [0,0,w]$
	$\bar{x},y,0 [0,0,\bar{w}]$	$x,\bar{y},0 [0,0,\bar{w}]$	$y,x,0 [0,0,\bar{w}]$	$\bar{y},\bar{x},0 [0,0,\bar{w}]$
4 g m'2'm.	$x,0,1/2 [0,v,0]$	$\bar{x},0,1/2 [0,\bar{v},0]$	$0,x,1/2 [\bar{v},0,0]$	$0,\bar{x},1/2 [v,0,0]$
4 f m2m.	$x,0,0 [0,0,0]$	$\bar{x},0,0 [0,0,0]$	$0,x,0 [0,0,0]$	$0,\bar{x},0 [0,0,0]$
4 e m'.2'm	$x,x,1/2 [u,\bar{u},0]$	$\bar{x},\bar{x},1/2 [\bar{u},u,0]$	$\bar{x},x,1/2 [u,u,0]$	$x,\bar{x},1/2 [\bar{u},\bar{u},0]$
4 d m.2m	$x,x,0 [0,0,0]$	$\bar{x},\bar{x},0 [0,0,0]$	$\bar{x},x,0 [0,0,0]$	$x,\bar{x},0 [0,0,0]$

Continued

No. 39.10.209

$p_{2c} 4/mmm$

2 c 4mm

0,0,z [0,0,0]

0,0, \bar{z} [0,0,0]

1 b 4/m'mm

0,0,1/2 [0,0,0]

1 a 4/mmm

0,0,0 [0,0,0]

Symmetry of special projections

Along [001] 4mm1'

Origin at 0,0,z

Along [100] $p2mm1'$

$a^* = c$

Origin at x,0,0

Along [110] $p2mm1'$

$a^* = c$

Origin at x,x,0

$p4/mcc$

$4/mmm$

Tetragonal

No. 40.1.210

$p4/m2/c2/c$

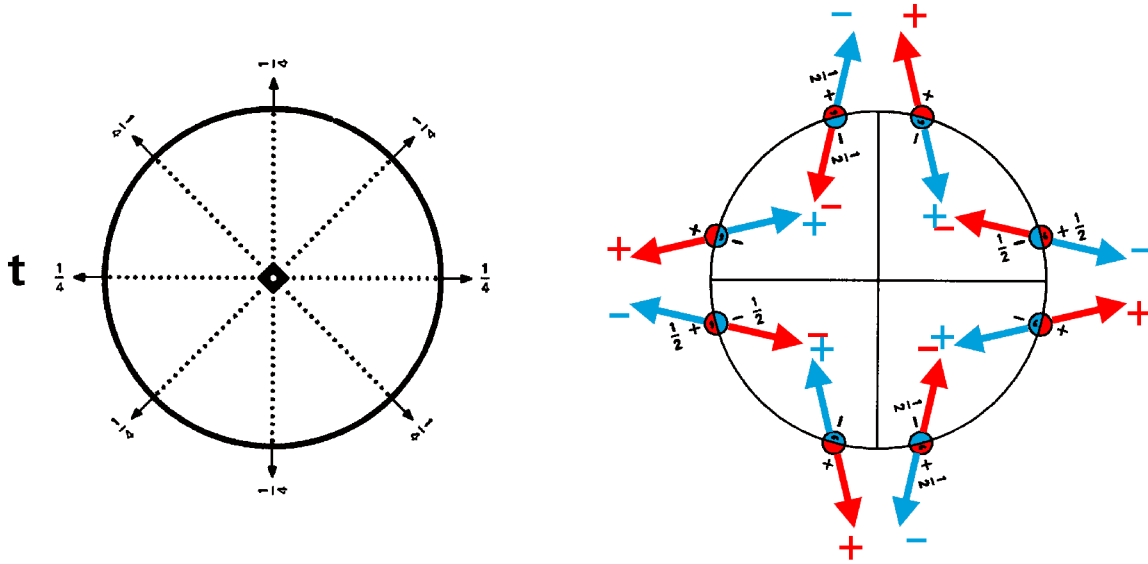

Origin at center ($4/m$) at $4/mcc$

Asymmetric unit $0 \leq x$; $0 \leq y$; $0 \leq z \leq 1/4$

Symmetry operations

- | | | | |
|---|---|---|---|
| (1) 1
($1 0,0,0$) | (2) $2_{0,0,z}$
($2_z 0,0,0$) | (3) $4^+_{0,0,z}$
($4_z^+ 0,0,0$) | (4) $4^-_{0,0,z}$
($4_z^- 0,0,0$) |
| (5) $2_{0,y,1/4}$
($2_y 0,0,1/2$) | (6) $2_{x,0,1/4}$
($2_x 0,0,1/2$) | (7) $2_{x,x,1/4}$
($2_{xy} 0,0,1/2$) | (8) $2_{x,\bar{x},1/4}$
($2_{\bar{xy}} 0,0,1/2$) |
| (9) $\bar{1}_{0,0,0}$
($\bar{1} 0,0,0$) | (10) $m_{x,y,0}$
($m_z 0,0,0$) | (11) $\bar{4}^+_{0,0,z}$; $0,0,0$
($\bar{4}_z^+ 0,0,0$) | (12) $\bar{4}^-_{0,0,z}$; $0,0,0$
($\bar{4}_z^- 0,0,0$) |
| (13) $c_{(0,0,1/2)}$ $x,0,z$
($m_y 0,0,1/2$) | (14) $c_{(0,0,1/2)}$ $0,y,z$
($m_x 0,0,1/2$) | (15) $c_{(0,0,1/2)}$ x,\bar{x},z
($m_{xy} 0,0,1/2$) | (16) $c_{(0,0,1/2)}$ x,x,z
($m_{\bar{xy}} 0,0,1/2$) |

Generators selected (1); t(0,0,1); (2); (3); (5); (9)

Positions

	Coordinates			
Multiplicity, Wyckoff letter, Site symmetry				
16 g 1	(1) x,y,z [u,v,w]	(2) \bar{x},\bar{y},z [\bar{u},\bar{v},w]	(3) \bar{y},x,z [\bar{v},u,w]	(4) y, \bar{x},z [v, \bar{u},w]
	(5) $\bar{x},y,\bar{z}+1/2$ [\bar{u},v,\bar{w}]	(6) x, $\bar{y},\bar{z}+1/2$ [u, \bar{v},\bar{w}]	(7) y,x, $\bar{z}+1/2$ [v,u, \bar{w}]	(8) $\bar{y},\bar{x},\bar{z}+1/2$ [\bar{v},\bar{u},\bar{w}]
	(9) \bar{x},\bar{y},\bar{z} [u,v,w]	(10) x,y, \bar{z} [\bar{u},\bar{v},w]	(11) y, \bar{x},\bar{z} [\bar{v},u,w]	(12) \bar{y},x,\bar{z} [v, \bar{u},w]
	(13) x, $\bar{y},z+1/2$ [\bar{u},v,\bar{w}]	(14) $\bar{x},y,z+1/2$ [u, \bar{v},\bar{w}]	(15) $\bar{y},\bar{x},z+1/2$ [v,u, \bar{w}]	(16) y,x,z+1/2 [\bar{v},\bar{u},\bar{w}]
8 f m..	x,y,0 [0,0,w]	$\bar{x},\bar{y},0$ [0,0,w]	$\bar{y},x,0$ [0,0,w]	y, $\bar{x},0$ [0,0,w]
	$\bar{x},y,1/2$ [0,0, \bar{w}]	x, $\bar{y},1/2$ [0,0, \bar{w}]	y,x,1/2 [0,0, \bar{w}]	$\bar{y},\bar{x},1/2$ [0,0, \bar{w}]
8 e .2.	x,0,1/4 [u,0,0]	$\bar{x},0,1/4$ [$\bar{u},0,0$]	0,x,1/4 [0,u,0]	0, $\bar{x},1/4$ [0, $\bar{u},0$]
	$\bar{x},0,3/4$ [u,0,0]	x,0,3/4 [$\bar{u},0,0$]	0, $\bar{x},3/4$ [0,u,0]	0,x,3/4 [0, $\bar{u},0$]
8 d ..2	x,x,1/4 [u,u,0]	$\bar{x},\bar{x},1/4$ [$\bar{u},\bar{u},0$]	$\bar{x},x,1/4$ [$\bar{u},u,0$]	x, $\bar{x},1/4$ [u, $\bar{u},0$]
	$\bar{x},\bar{x},3/4$ [u,u,0]	x,x,3/4 [$\bar{u},\bar{u},0$]	x, $\bar{x},3/4$ [$\bar{u},u,0$]	$\bar{x},x,3/4$ [u, $\bar{u},0$]
4 c 4..	0,0,z [0,0,w]	0,0, $\bar{z}+1/2$ [0,0, \bar{w}]	0,0, \bar{z} [0,0,w]	0,0,z+1/2[0,0, \bar{w}]
2 b 4/m..	0,0,0 [0,0,w]	0,0,1/2 [0,0, \bar{w}]		
2 a 422	0,0,1/4 [0,0,0]	0,0,3/4 [0,0,0]		

Symmetry of special projections

Along [001] 4mm1'	Along [100] $p_{2a^*} 2'mm'$ $a^* = c/2$	Along [110] $p_{2a^*} 2'mm'$ $a^* = c/2$
Origin at 0,0,z	Origin at x,0,0	Origin at x,x,0

$p4/mcc1'$

$4/mmm1'$

Tetragonal

No. 40.2.211

$p4/m2/c2/c1'$

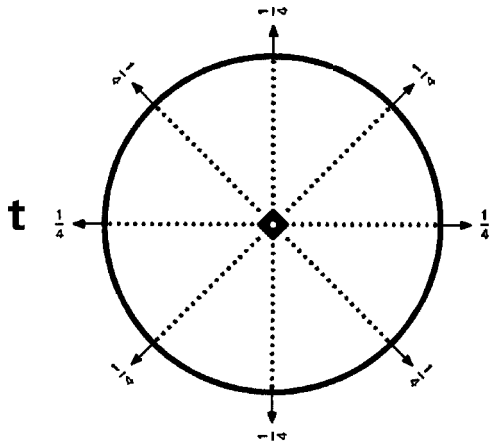

1'

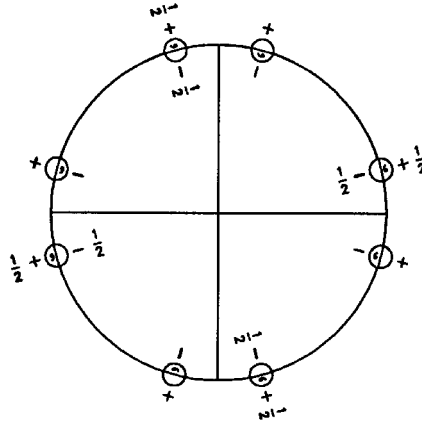

Origin at center ($4/m1'$) at $4/mcc1'$

Asymmetric unit $0 \leq x$; $0 \leq y$; $0 \leq z \leq 1/4$

Symmetry operations

For 1 + set

- | | | | |
|---|---|--|---|
| (1) 1
(1 0,0,0) | (2) 2 0,0,z
(2 _z 0,0,0) | (3) 4 ⁺ 0,0,z
(4 _z 0,0,0) | (4) 4 ⁻ 0,0,z
(4 _z ⁻¹ 0,0,0) |
| (5) 2 0,y,1/4
(2 _y 0,0,1/2) | (6) 2 x,0,1/4
(2 _x 0,0,1/2) | (7) 2 x,x,1/4
(2 _{xy} 0,0,1/2) | (8) 2 x, \bar{x} ,1/4
(2 _{xy} 0,0,1/2) |
| (9) $\bar{1}$ 0,0,0
($\bar{1}$ 0,0,0) | (10) m x,y,0
(m _z 0,0,0) | (11) $\bar{4}^+$ 0,0,z; 0,0,0
($\bar{4}_z$ 0,0,0) | (12) $\bar{4}^-$ 0,0,z; 0,0,0
($\bar{4}_z^{-1}$ 0,0,0) |
| (13) c (0,0,1/2) x,0,z
(m _y 0,0,1/2) | (14) c (0,0,1/2) 0,y,z
(m _x 0,0,1/2) | (15) c (0,0,1/2) x, \bar{x} ,z
(m _{xy} 0,0,1/2) | (16) c (0,0,1/2) x,x,z
(m _{xy} 0,0,1/2) |

For 1' + set

- | | | | |
|---|---|--|--|
| (1) 1'
(1 0,0,0)' | (2) 2' 0,0,z
(2 _z 0,0,0)' | (3) 4 ⁺ ' 0,0,z
(4 _z 0,0,0)' | (4) 4 ⁻ ' 0,0,z
(4 _z ⁻¹ 0,0,0)' |
| (5) 2' 0,y,1/4
(2 _y 0,0,1/2)' | (6) 2' x,0,1/4
(2 _x 0,0,1/2)' | (7) 2' x,x,1/4
(2 _{xy} 0,0,1/2)' | (8) 2' x, \bar{x} ,1/4
(2 _{xy} 0,0,1/2)' |
| (9) $\bar{1}'$ 0,0,0
($\bar{1}$ 0,0,0)' | (10) m' x,y,0
(m _z 0,0,0)' | (11) $\bar{4}^+$ ' 0,0,z; 0,0,0
($\bar{4}_z$ 0,0,0)' | (12) $\bar{4}^-$ ' 0,0,z; 0,0,0
($\bar{4}_z^{-1}$ 0,0,0)' |
| (13) c' (0,0,1/2) x,0,z
(m _y 0,0,1/2)' | (14) c' (0,0,1/2) 0,y,z
(m _x 0,0,1/2)' | (15) c' (0,0,1/2) x, \bar{x} ,z
(m _{xy} 0,0,1/2)' | (16) c' (0,0,1/2) x,x,z
(m _{xy} 0,0,1/2)' |

Generators selected (1); t(0,0,1)'; (2); (3); (5); (9)

Positions

Multiplicity, Wyckoff letter, Site symmetry	Coordinates			
	(0,0,0)+	(0,0,1)'		
16 g 11'	(1) x,y,z [0,0,0]	(2) \bar{x},\bar{y},z [0,0,0]	(3) \bar{y},x,z [0,0,0]	(4) y, \bar{x},z [0,0,0]
	(5) $\bar{x},y,\bar{z}+1/2$ [0,0,0]	(6) x, $\bar{y},\bar{z}+1/2$ [0,0,0]	(7) y,x, $\bar{z}+1/2$ [0,0,0]	(8) $\bar{y},\bar{x},\bar{z}+1/2$ [0,0,0]
	(9) \bar{x},\bar{y},\bar{z} [0,0,0]	(10) x,y, \bar{z} [0,0,0]	(11) y, \bar{x},\bar{z} [0,0,0]	(12) \bar{y},x,\bar{z} [0,0,0]
	(13) x, $\bar{y},z+1/2$ [0,0,0]	(14) $\bar{x},y,z+1/2$ [0,0,0]	(15) $\bar{y},\bar{x},z+1/2$ [0,0,0]	(16) y,x,z+1/2 [0,0,0]
8 f m..1'	x,y,0 [0,0,0]	$\bar{x},\bar{y},0$ [0,0,0]	$\bar{y},x,0$ [0,0,0]	y, $\bar{x},0$ [0,0,0]
	$\bar{x},y,1/2$ [0,0,0]	x, $\bar{y},1/2$ [0,0,0]	y,x,1/2 [0,0,0]	$\bar{y},\bar{x},1/2$ [0,0,0]
8 e .2.1'	x,0,1/4 [0,0,0]	$\bar{x},0,1/4$ [0,0,0]	0,x,1/4 [0,0,0]	0, $\bar{x},1/4$ [0,0,0]
	$\bar{x},0,3/4$ [0,0,0]	x,0,3/4 [0,0,0]	0, $\bar{x},3/4$ [0,0,0]	0,x,3/4 [0,0,0]
8 d ..21'	x,x,1/4 [0,0,0]	$\bar{x},\bar{x},1/4$ [0,0,0]	$\bar{x},x,1/4$ [0,0,0]	x, $\bar{x},1/4$ [0,0,0]
	$\bar{x},\bar{x},3/4$ [0,0,0]	x,x,3/4 [0,0,0]	x, $\bar{x},3/4$ [0,0,0]	$\bar{x},x,3/4$ [0,0,0]
4 c 4..1'	0,0,z [0,0,0]	0,0, $\bar{z}+1/2$ [0,0,0]	0,0, \bar{z} [0,0,0]	0,0,z+1/2 [0,0,0]
2 b 4/m..1'	0,0,0 [0,0,0]	0,0,1/2 [0,0,0]		
2 a 4221'	0,0,1/4 [0,0,0]	0,0,3/4 [0,0,0]		

Symmetry of special projections

Along [001] 4mm1'	Along [100] p2mm1'	Along [110] p2mm1'
Origin at 0,0,z	a* = c/2 Origin at x,0,0	a* = c/2 Origin at x,x,0

$p4/m'c'c'$

$4/m'm'm'$

Tetragonal

No. 40.3.212

$p4/m'2/c'2/c'$

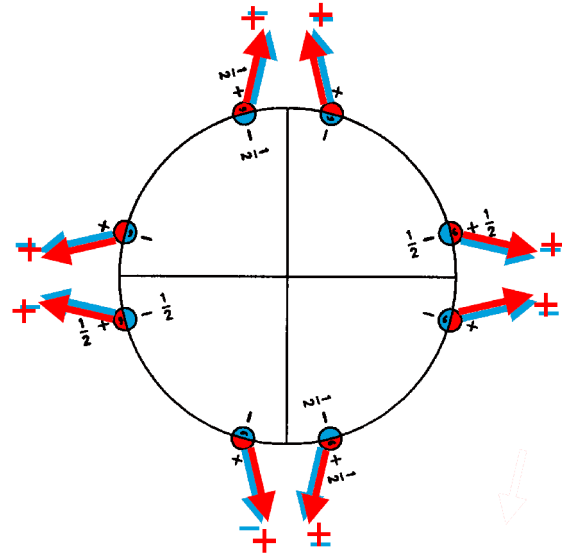
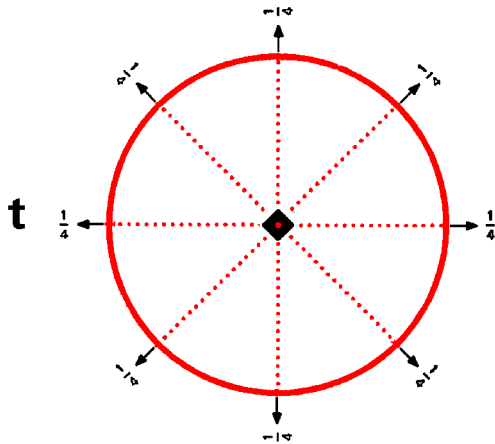

Origin at center ($4/m'$) at $4/m'c'c'$

Asymmetric unit $0 \leq x$; $0 \leq y$; $0 \leq z \leq 1/4$

Symmetry operations

- | | | | |
|---|---|---|---|
| (1) 1
(1 0,0,0) | (2) 2 0,0,z
(2 _z 0,0,0) | (3) 4 ⁺ 0,0,z
(4 _z 0,0,0) | (4) 4 ⁻ 0,0,z
(4 _z ⁻¹ 0,0,0) |
| (5) 2 0,y,1/4
(2 _y 0,0,1/2) | (6) 2 x,0,1/4
(2 _x 0,0,1/2) | (7) 2 x,x,1/4
(2 _{xy} 0,0,1/2) | (8) 2 x, \bar{x} ,1/4
(2 _{\bar{xy}} 0,0,1/2) |
| (9) $\bar{1}$ 0,0,0
($\bar{1}$ 0,0,0)' | (10) m' x,y,0
(m _z 0,0,0)' | (11) $\bar{4}$ ⁺ 0,0,z; 0,0,0
($\bar{4}$ _z 0,0,0)' | (12) $\bar{4}$ ⁻ 0,0,z; 0,0,0
($\bar{4}$ _z ⁻¹ 0,0,0)' |
| (13) c' (0,0,1/2) x,0,z
(m _y 0,0,1/2)' | (14) c' (0,0,1/2) 0,y,z
(m _x 0,0,1/2)' | (15) c' (0,0,1/2) x, \bar{x} ,z
(m _{xy} 0,0,1/2)' | (16) c' (0,0,1/2) x,x,z
(m _{\bar{xy}} 0,0,1/2)' |

Generators selected (1); $t(0,0,1)$; (2); (3); (5); (9)

Positions

	Coordinates			
Multiplicity, Wyckoff letter, Site symmetry				
16 g 1	(1) $x,y,z [u,v,w]$	(2) $\bar{x},\bar{y},z [\bar{u},\bar{v},w]$	(3) $\bar{y},x,z [\bar{v},u,w]$	(4) $y,\bar{x},z [v,\bar{u},w]$
	(5) $\bar{x},y,\bar{z}+1/2 [\bar{u},v,\bar{w}]$	(6) $x,\bar{y},\bar{z}+1/2 [u,\bar{v},\bar{w}]$	(7) $y,x,\bar{z}+1/2 [v,u,\bar{w}]$	(8) $\bar{y},\bar{x},\bar{z}+1/2 [\bar{v},\bar{u},\bar{w}]$
	(9) $\bar{x},\bar{y},\bar{z} [\bar{u},\bar{v},\bar{w}]$	(10) $x,y,\bar{z} [u,v,\bar{w}]$	(11) $y,\bar{x},\bar{z} [v,\bar{u},\bar{w}]$	(12) $\bar{y},x,\bar{z} [\bar{v},u,\bar{w}]$
	(13) $x,\bar{y},z+1/2 [u,\bar{v},w]$	(14) $\bar{x},y,z+1/2 [\bar{u},v,w]$	(15) $\bar{y},\bar{x},z+1/2 [\bar{v},\bar{u},w]$	(16) $y,x,z+1/2 [v,u,w]$
8 f m'..	$x,y,0 [u,v,0]$	$\bar{x},\bar{y},0 [\bar{u},\bar{v},0]$	$\bar{y},x,0 [\bar{v},u,0]$	$y,\bar{x},0 [v,\bar{u},0]$
	$\bar{x},y,1/2 [\bar{u},v,0]$	$x,\bar{y},1/2 [u,\bar{v},0]$	$y,x,1/2 [v,u,0]$	$\bar{y},\bar{x},1/2 [\bar{v},\bar{u},0]$
8 e .2.	$x,0,1/4 [u,0,0]$	$\bar{x},0,1/4 [\bar{u},0,0]$	$0,x,1/4 [0,u,0]$	$0,\bar{x},1/4 [0,\bar{u},0]$
	$\bar{x},0,3/4 [\bar{u},0,0]$	$x,0,3/4 [u,0,0]$	$0,\bar{x},3/4 [0,\bar{u},0]$	$0,x,3/4 [0,u,0]$
8 d ..2	$x,x,1/4 [u,u,0]$	$\bar{x},\bar{x},1/4 [\bar{u},\bar{u},0]$	$\bar{x},x,1/4 [\bar{u},u,0]$	$x,\bar{x},1/4 [u,\bar{u},0]$
	$\bar{x},\bar{x},3/4 [\bar{u},\bar{u},0]$	$x,x,3/4 [u,u,0]$	$x,\bar{x},3/4 [u,\bar{u},0]$	$\bar{x},x,3/4 [\bar{u},u,0]$
4 c 4..	$0,0,z [0,0,w]$	$0,0,\bar{z}+1/2 [0,0,\bar{w}]$	$0,0,\bar{z} [0,0,\bar{w}]$	$0,0,z+1/2 [0,0,w]$
2 b 4/m'..	$0,0,0 [0,0,0]$	$0,0,1/2 [0,0,0]$		
2 a 422	$0,0,1/4 [0,0,0]$	$0,0,3/4 [0,0,0]$		

Symmetry of special projections

Along [001] $4m'm'$	Along [100] $p2m'm'$	Along [110] $p2m'm'$
Origin at 0,0,z	$a^* = c/2$ Origin at x,0,0	$a^* = c/2$ Origin at x,x,0

$p4/mc'c'$

$4/mm'm'$

Tetragonal

No. 40.4.213

$p4/m2'c'2'/c'$

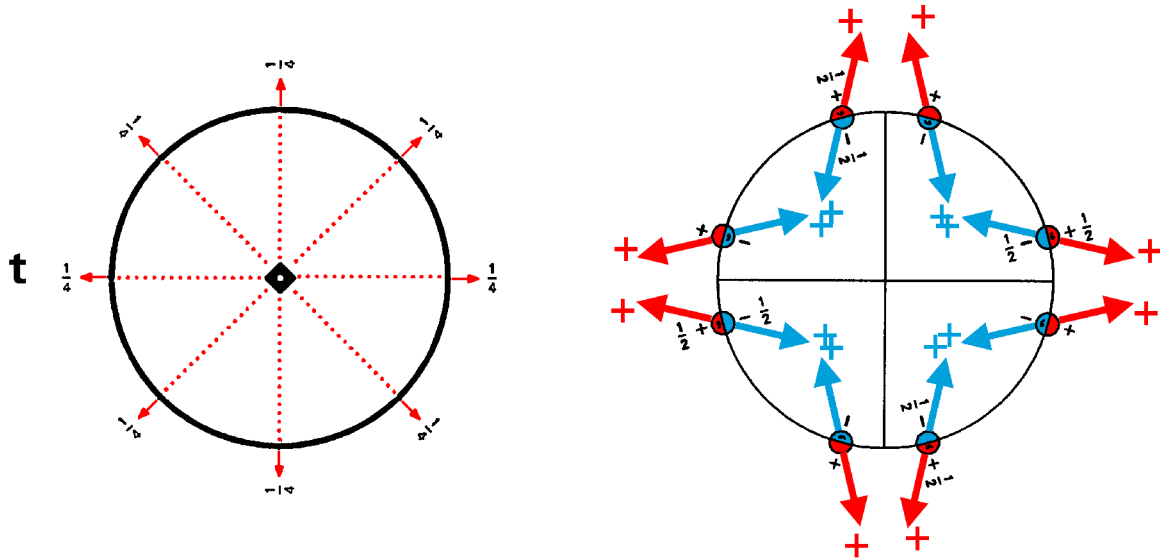

Origin at center ($4/m$) at $4/mc'c'$

Asymmetric unit $0 \leq x; 0 \leq y; 0 \leq z \leq 1/4$

Symmetry operations

- | | | | |
|---|---|--|---|
| (1) 1
(1 0,0,0) | (2) 2 $0,0,z$
(2_z 0,0,0) | (3) 4^+ $0,0,z$
(4_z 0,0,0) | (4) 4^- $0,0,z$
(4_z^{-1} 0,0,0) |
| (5) $2'$ $0,y,1/4$
(2_y 0,0,1/2)' | (6) $2'$ $x,0,1/4$
(2_x 0,0,1/2)' | (7) $2'$ $x,x,1/4$
(2_{xy} 0,0,1/2)' | (8) $2'$ $x,\bar{x},1/4$
($2_{\bar{xy}}$ 0,0,1/2)' |
| (9) $\bar{1}$ $0,0,0$
($\bar{1}$ 0,0,0) | (10) m $x,y,0$
(m_z 0,0,0) | (11) $\bar{4}^+$ $0,0,z; 0,0,0$
($\bar{4}_z$ 0,0,0) | (12) $\bar{4}^-$ $0,0,z; 0,0,0$
($\bar{4}_z^{-1}$ 0,0,0) |
| (13) c' $(0,0,1/2)$ $x,0,z$
(m_y 0,0,1/2)' | (14) c' $(0,0,1/2)$ $0,y,z$
(m_x 0,0,1/2)' | (15) c' $(0,0,1/2)$ x,\bar{x},z
(m_{xy} 0,0,1/2)' | (16) c' $(0,0,1/2)$ x,x,z
($m_{\bar{xy}}$ 0,0,1/2)' |

Generators selected (1); t(0,0,1); (2); (3); (5); (9)

Positions

	Coordinates			
Multiplicity, Wyckoff letter, Site symmetry				
16 g 1	(1) x,y,z [u,v,w]	(2) \bar{x},\bar{y},z [\bar{u},\bar{v},w]	(3) \bar{y},x,z [\bar{v},u,w]	(4) y,\bar{x},z [v,\bar{u},w]
	(5) $\bar{x},y,\bar{z}+1/2$ [u,\bar{v},w]	(6) $x,\bar{y},\bar{z}+1/2$ [\bar{u},v,w]	(7) $y,x,\bar{z}+1/2$ [\bar{v},\bar{u},w]	(8) $\bar{y},\bar{x},\bar{z}+1/2$ [v,u,w]
	(9) \bar{x},\bar{y},\bar{z} [u,v,w]	(10) x,y,\bar{z} [\bar{u},\bar{v},w]	(11) y,\bar{x},\bar{z} [\bar{v},u,w]	(12) \bar{y},x,\bar{z} [v,\bar{u},w]
	(13) $x,\bar{y},z+1/2$ [u,\bar{v},w]	(14) $\bar{x},y,z+1/2$ [\bar{u},v,w]	(15) $\bar{y},\bar{x},z+1/2$ [\bar{v},\bar{u},w]	(16) $y,x,z+1/2$ [v,u,w]
8 f m..	x,y,0 [0,0,w]	$\bar{x},\bar{y},0$ [0,0,w]	$\bar{y},x,0$ [0,0,w]	$y,\bar{x},0$ [0,0,w]
	$\bar{x},y,1/2$ [0,0,w]	$x,\bar{y},1/2$ [0,0,w]	$y,x,1/2$ [0,0,w]	$\bar{y},\bar{x},1/2$ [0,0,w]
8 e .2'	x,0,1/4 [0,v,w]	$\bar{x},0,1/4$ [0, \bar{v},w]	0,x,1/4 [$\bar{v},0,w$]	0, $\bar{x},1/4$ [v,0,w]
	$\bar{x},0,3/4$ [0,v,w]	$x,0,3/4$ [0, \bar{v},w]	0, $\bar{x},3/4$ [$\bar{v},0,w$]	0,x,3/4 [v,0,w]
8 d ..2'	x,x,1/4 [u, \bar{u},w]	$\bar{x},\bar{x},1/4$ [\bar{u},u,w]	$\bar{x},x,1/4$ [u,u,w]	x, $\bar{x},1/4$ [\bar{u},\bar{u},w]
	$\bar{x},\bar{x},3/4$ [u, \bar{u},w]	$x,x,3/4$ [\bar{u},u,w]	$x,\bar{x},3/4$ [u,u,w]	$\bar{x},x,3/4$ [\bar{u},\bar{u},w]
4 c 4..	0,0,z [0,0,w]	0,0, $\bar{z}+1/2$ [0,0,w]	0,0, \bar{z} [0,0,w]	0,0,z+1/2[0,0,w]
2 b 4/m..	0,0,0 [0,0,w]	0,0,1/2 [0,0,w]		
2 a 42'2'	0,0,1/4 [0,0,w]	0,0,3/4 [0,0,w]		

Symmetry of special projections

Along [001] 4mm1'	Along [100] p2'mm'	Along [110] p2'mm'
Origin at 0,0,z	a* = c/2 Origin at x,0,0	a* = c/2 Origin at x,x,0

$p4/m'cc$

$4/m'mm$

Tetragonal

No. 40.5.214

$p4/m'2'/c2'/c$

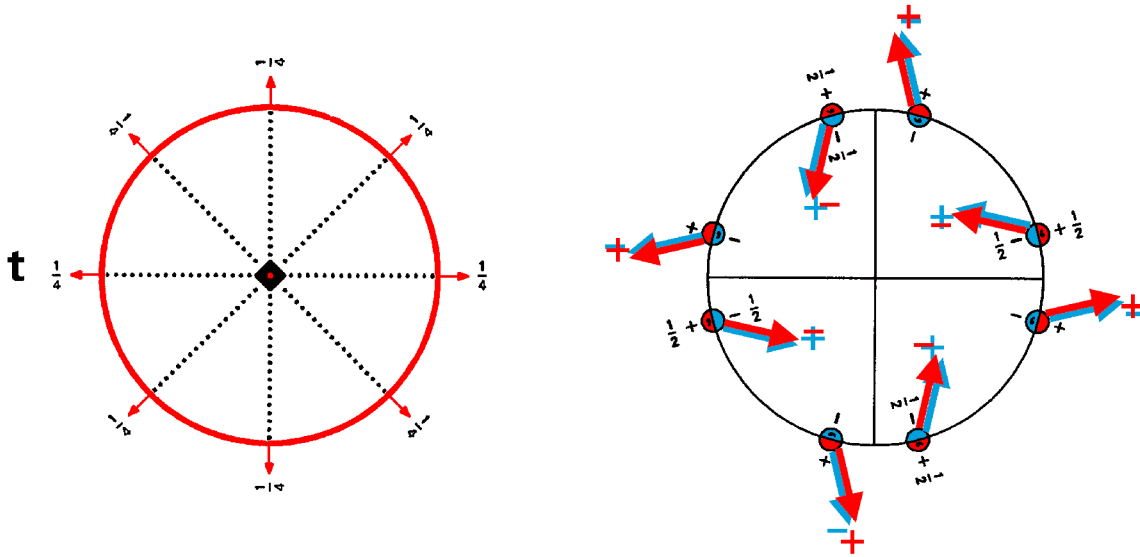

Origin at center ($4/m'$) at $4/m'cc$

Asymmetric unit $0 \leq x$; $0 \leq y$; $0 \leq z \leq 1/4$

Symmetry operations

- | | | | |
|---|---|--|--|
| (1) 1
(1 0,0,0) | (2) 2 $0,0,z$
(2_z 0,0,0) | (3) 4^+ $0,0,z$
(4_z 0,0,0) | (4) 4^- $0,0,z$
(4_z^{-1} 0,0,0) |
| (5) $2'$ $0,y,1/4$
(2_y 0,0,1/2)' | (6) $2'$ $x,0,1/4$
(2_x 0,0,1/2)' | (7) $2'$ $x,x,1/4$
(2_{xy} 0,0,1/2)' | (8) $2'$ $x,\bar{x},1/4$
($2_{\bar{xy}}$ 0,0,1/2)' |
| (9) $\bar{1}$ $0,0,0$
($\bar{1}$ 0,0,0)' | (10) m' $x,y,0$
(m_z 0,0,0)' | (11) $\bar{4}^+$ $0,0,z; 0,0,0$
($\bar{4}_z$ 0,0,0)' | (12) $\bar{4}^-$ $0,0,z; 0,0,0$
($\bar{4}_z^{-1}$ 0,0,0)' |
| (13) c $(0,0,1/2)$ $x,0,z$
(m_y 0,0,1/2) | (14) c $(0,0,1/2)$ $0,y,z$
(m_x 0,0,1/2) | (15) c $(0,0,1/2)$ x,\bar{x},z
(m_{xy} 0,0,1/2) | (16) c $(0,0,1/2)$ x,x,z
($m_{\bar{xy}}$ 0,0,1/2) |

Generators selected (1); t(0,0,1); (2); (3); (5); (9)

Positions

	Coordinates			
Multiplicity, Wyckoff letter, Site symmetry				
16 g 1	(1) x,y,z [u,v,w]	(2) \bar{x},\bar{y},z [\bar{u},\bar{v},w]	(3) \bar{y},x,z [\bar{v},u,w]	(4) y,\bar{x},z [v,\bar{u},w]
	(5) $\bar{x},y,\bar{z}+1/2$ [u,\bar{v},w]	(6) $x,\bar{y},\bar{z}+1/2$ [\bar{u},v,w]	(7) $y,x,\bar{z}+1/2$ [\bar{v},\bar{u},w]	(8) $\bar{y},\bar{x},\bar{z}+1/2$ [v,u,w]
	(9) \bar{x},\bar{y},\bar{z} [\bar{u},\bar{v},\bar{w}]	(10) x,y,\bar{z} [u,v,\bar{w}]	(11) y,\bar{x},\bar{z} [v,\bar{u},\bar{w}]	(12) \bar{y},x,\bar{z} [\bar{v},u,\bar{w}]
	(13) $x,\bar{y},z+1/2$ [\bar{u},v,\bar{w}]	(14) $\bar{x},y,z+1/2$ [u,\bar{v},\bar{w}]	(15) $\bar{y},\bar{x},z+1/2$ [v,u,\bar{w}]	(16) $y,x,z+1/2$ [\bar{v},\bar{u},\bar{w}]
8 f m'..	x,y,0 [u,v,0]	$\bar{x},\bar{y},0$ [$\bar{u},\bar{v},0$]	$\bar{y},x,0$ [$\bar{v},u,0$]	$y,\bar{x},0$ [$v,\bar{u},0$]
	$\bar{x},y,1/2$ [$u,\bar{v},0$]	$x,\bar{y},1/2$ [$\bar{u},v,0$]	$y,x,1/2$ [$\bar{v},\bar{u},0$]	$\bar{y},\bar{x},1/2$ [$v,u,0$]
8 e .2'	x,0,1/4 [0,v,w]	$\bar{x},0,1/4$ [0, \bar{v},w]	0,x,1/4 [$\bar{v},0,w$]	0, $\bar{x},1/4$ [$v,0,w$]
	$\bar{x},0,3/4$ [0, \bar{v},\bar{w}]	$x,0,3/4$ [0,v, \bar{w}]	0, $\bar{x},3/4$ [$v,0,\bar{w}$]	0,x,3/4 [$\bar{v},0,\bar{w}$]
8 d ..2'	x,x,1/4 [u, \bar{u},w]	$\bar{x},\bar{x},1/4$ [\bar{u},u,w]	$\bar{x},x,1/4$ [u,u,w]	x, $\bar{x},1/4$ [\bar{u},\bar{u},w]
	$\bar{x},\bar{x},3/4$ [\bar{u},u,\bar{w}]	$x,x,3/4$ [u, \bar{u},\bar{w}]	$x,\bar{x},3/4$ [\bar{u},\bar{u},\bar{w}]	$\bar{x},x,3/4$ [u,u, \bar{w}]
4 c 4..	0,0,z [0,0,w]	0,0, $\bar{z}+1/2$ [0,0,w]	0,0, \bar{z} [0,0, \bar{w}]	0,0,z+1/2[0,0, \bar{w}]
2 b 4/m'..	0,0,0 [0,0,0]	0,0,1/2 [0,0,0]		
2 a 42'2'	0,0,1/4 [0,0,w]	0,0,3/4 [0,0, \bar{w}]		

Symmetry of special projections

Along [001] 4mm	Along [100] $p_{2a^*}2'mm'$ $a^* = c/2$	Along [110] $p_{2a^*}2'mm'$ $a^* = c/2$
Origin at 0,0,z	Origin at x,0,0	Origin at x,x,0

$p4'/m'c'c$

$4'/m'm'm$

Tetragonal

No. 40.6.215

$p4'/m'2/c'2'/c$

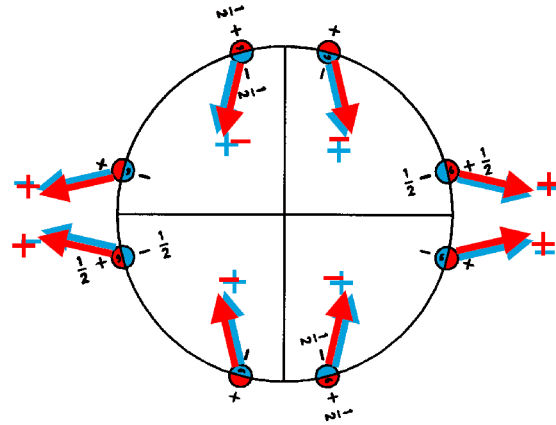
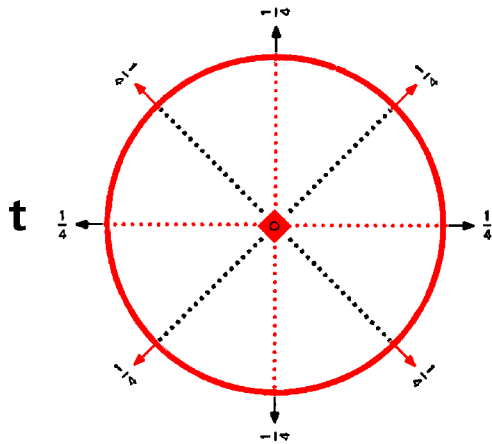

Origin at center ($4'/m'$) at $4'/m'c'c$

Asymmetric unit $0 \leq x; 0 \leq y; 0 \leq z \leq 1/4$

Symmetry operations

- | | | | |
|---|---|--|--|
| (1) 1
(1 0,0,0) | (2) 2 0,0,z
(2 _z 0,0,0) | (3) 4 ⁺ 0,0,z
(4 _z 0,0,0)' | (4) 4 ⁻ 0,0,z
(4 _z ⁻¹ 0,0,0)' |
| (5) 2 0,y,1/4
(2 _y 0,0,1/2) | (6) 2 x,0,1/4
(2 _x 0,0,1/2) | (7) 2' x,x,1/4
(2 _{xy} 0,0,1/2)' | (8) 2' x,x̄,1/4
(2 _{x̄y} 0,0,1/2)' |
| (9) $\bar{1}$ 0,0,0
($\bar{1}$ 0,0,0)' | (10) m' x,y,0
(m _z 0,0,0)' | (11) $\bar{4}$ ⁺ 0,0,z; 0,0,0
($\bar{4}$ _z 0,0,0) | (12) $\bar{4}$ ⁻ 0,0,z; 0,0,0
($\bar{4}$ _z ⁻¹ 0,0,0) |
| (13) c' (0,0,1/2) x,0,z
(m _y 0,0,1/2)' | (14) c' (0,0,1/2) 0,y,z
(m _x 0,0,1/2)' | (15) c (0,0,1/2) x,x̄,z
(m _{xy} 0,0,1/2) | (16) c (0,0,1/2) x,x,z
(m _{x̄y} 0,0,1/2) |

Generators selected (1); $t(0,0,1)$; (2); (3); (5); (9)

Positions

	Coordinates			
Multiplicity, Wyckoff letter, Site symmetry				
16 g 1	(1) x,y,z [u,v,w]	(2) \bar{x},\bar{y},z [\bar{u},\bar{v},w]	(3) \bar{y},x,z [v,\bar{u},\bar{w}]	(4) y,\bar{x},z [\bar{v},u,\bar{w}]
	(5) $\bar{x},y,\bar{z}+1/2$ [\bar{u},v,\bar{w}]	(6) $x,\bar{y},\bar{z}+1/2$ [u,\bar{v},\bar{w}]	(7) $y,x,\bar{z}+1/2$ [\bar{v},\bar{u},w]	(8) $\bar{y},\bar{x},\bar{z}+1/2$ [v,u,w]
	(9) \bar{x},\bar{y},\bar{z} [\bar{u},\bar{v},\bar{w}]	(10) x,y,\bar{z} [u,v,\bar{w}]	(11) y,\bar{x},\bar{z} [\bar{v},u,w]	(12) \bar{y},x,\bar{z} [v,\bar{u},w]
	(13) $x,\bar{y},z+1/2$ [u,\bar{v},w]	(14) $\bar{x},y,z+1/2$ [\bar{u},v,w]	(15) $\bar{y},\bar{x},z+1/2$ [v,u,\bar{w}]	(16) $y,x,z+1/2$ [\bar{v},\bar{u},\bar{w}]
8 f $m'..$	$x,y,0$ [$u,v,0$]	$\bar{x},\bar{y},0$ [$\bar{u},\bar{v},0$]	$\bar{y},x,0$ [$v,\bar{u},0$]	$y,\bar{x},0$ [$\bar{v},u,0$]
	$\bar{x},y,1/2$ [$\bar{u},v,0$]	$x,\bar{y},1/2$ [$u,\bar{v},0$]	$y,x,1/2$ [$\bar{v},\bar{u},0$]	$\bar{y},\bar{x},1/2$ [$v,u,0$]
8 e $.2.$	$x,0,1/4$ [$u,0,0$]	$\bar{x},0,1/4$ [$\bar{u},0,0$]	$0,x,1/4$ [$0,\bar{u},0$]	$0,\bar{x},1/4$ [$0,u,0$]
	$\bar{x},0,3/4$ [$\bar{u},0,0$]	$x,0,3/4$ [$u,0,0$]	$0,\bar{x},3/4$ [$0,u,0$]	$0,x,3/4$ [$0,\bar{u},0$]
8 d $..2'$	$x,x,1/4$ [u,\bar{u},w]	$\bar{x},\bar{x},1/4$ [\bar{u},u,w]	$\bar{x},x,1/4$ [\bar{u},\bar{u},\bar{w}]	$x,\bar{x},1/4$ [u,u,\bar{w}]
	$\bar{x},\bar{x},3/4$ [\bar{u},u,\bar{w}]	$x,x,3/4$ [u,\bar{u},\bar{w}]	$x,\bar{x},3/4$ [u,u,w]	$\bar{x},x,3/4$ [\bar{u},\bar{u},w]
4 c $4'..$	$0,0,z$ [$0,0,0$]	$0,0,\bar{z}+1/2$ [$0,0,0$]	$0,0,\bar{z}$ [$0,0,0$]	$0,0,z+1/2$ [$0,0,0$]
2 b $4'/m'..$	$0,0,0$ [$0,0,0$]	$0,0,1/2$ [$0,0,0$]		
2 a $4'22'$	$0,0,1/4$ [$0,0,0$]	$0,0,3/4$ [$0,0,0$]		

Symmetry of special projections

Along [001] $4'm'm'$	Along [100] $p2m'm'$	Along [110] $p_{2a^*}2m'm'$
Origin at $0,0,z$	$a^* = c/2$ Origin at $x,0,0$	$a^* = c/2$ Origin at $x,x,0$

$p4'/mcc'$

$4'/mmm'$

Tetragonal

No. 40.7.216

$p4'/m2/c2'/c'$

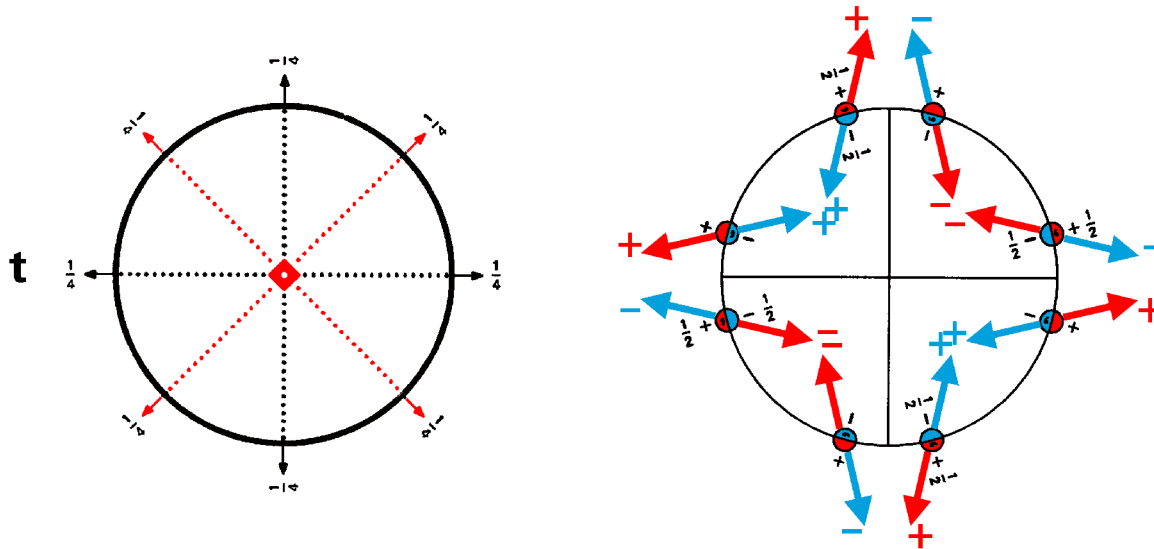

Origin at center ($4'/m$) at $4'/mcc'$

Asymmetric unit $0 \leq x$; $0 \leq y$; $0 \leq z \leq 1/4$

Symmetry operations

- | | | | |
|---|---|---|---|
| (1) 1
(1 0,0,0) | (2) 2 0,0,z
(2 _z 0,0,0) | (3) 4 ⁺ 0,0,z
(4 _z 0,0,0)' | (4) 4 ⁻ 0,0,z
(4 _z ⁻¹ 0,0,0)' |
| (5) 2 0,y,1/4
(2 _y 0,0,1/2) | (6) 2 x,0,1/4
(2 _x 0,0,1/2) | (7) 2' x,x,1/4
(2 _{xy} 0,0,1/2)' | (8) 2' x,x̄,1/4
(2 _{x̄y} 0,0,1/2)' |
| (9) $\bar{1}$ 0,0,0
($\bar{1}$ 0,0,0) | (10) m x,y,0
(m _z 0,0,0) | (11) $\bar{4}$ ⁺ 0,0,z; 0,0,0
($\bar{4}$ _z 0,0,0)' | (12) $\bar{4}$ ⁻ 0,0,z; 0,0,0
($\bar{4}$ _z ⁻¹ 0,0,0)' |
| (13) c (0,0,1/2) x,0,z
(m _y 0,0,1/2) | (14) c (0,0,1/2) 0,y,z
(m _x 0,0,1/2) | (15) c' (0,0,1/2) x,x̄,z
(m _{xy} 0,0,1/2)' | (16) c' (0,0,1/2) x,x,z
(m _{x̄y} 0,0,1/2)' |

Generators selected (1); t(0,0,1); (2); (3); (5); (9)

Positions

	Coordinates			
Multiplicity, Wyckoff letter, Site symmetry				
16 g 1	(1) x,y,z [u,v,w]	(2) \bar{x},\bar{y},z [\bar{u},\bar{v},w]	(3) \bar{y},x,z [v,\bar{u},\bar{w}]	(4) y,\bar{x},z [\bar{v},u,\bar{w}]
	(5) $\bar{x},y,\bar{z}+1/2$ [\bar{u},v,\bar{w}]	(6) $x,\bar{y},\bar{z}+1/2$ [u,\bar{v},\bar{w}]	(7) $y,x,\bar{z}+1/2$ [\bar{v},\bar{u},w]	(8) $\bar{y},\bar{x},\bar{z}+1/2$ [v,u,w]
	(9) \bar{x},\bar{y},\bar{z} [u,v,w]	(10) x,y,\bar{z} [\bar{u},\bar{v},w]	(11) y,\bar{x},\bar{z} [v,\bar{u},\bar{w}]	(12) \bar{y},x,\bar{z} [\bar{v},u,\bar{w}]
	(13) $x,\bar{y},z+1/2$ [\bar{u},v,\bar{w}]	(14) $\bar{x},y,z+1/2$ [u,\bar{v},\bar{w}]	(15) $\bar{y},\bar{x},z+1/2$ [\bar{v},\bar{u},w]	(16) $y,x,z+1/2$ [v,u,w]
8 f m..	$x,y,0$ [0,0,w]	$\bar{x},\bar{y},0$ [0,0,w]	$\bar{y},x,0$ [0,0, \bar{w}]	$y,\bar{x},0$ [0,0, \bar{w}]
	$\bar{x},y,1/2$ [0,0, \bar{w}]	$x,\bar{y},1/2$ [0,0, \bar{w}]	$y,x,1/2$ [0,0,w]	$\bar{y},\bar{x},1/2$ [0,0,w]
8 e .2.	$x,0,1/4$ [u,0,0]	$\bar{x},0,1/4$ [$\bar{u},0,0$]	$0,x,1/4$ [0, $\bar{u},0$]	$0,\bar{x},1/4$ [0,u,0]
	$\bar{x},0,3/4$ [u,0,0]	$x,0,3/4$ [$\bar{u},0,0$]	$0,\bar{x},3/4$ [0, $\bar{u},0$]	$0,x,3/4$ [0,u,0]
8 d ..2'	$x,x,1/4$ [u, \bar{u},w]	$\bar{x},\bar{x},1/4$ [\bar{u},u,w]	$\bar{x},x,1/4$ [\bar{u},\bar{u},\bar{w}]	$x,\bar{x},1/4$ [u,u, \bar{w}]
	$\bar{x},\bar{x},3/4$ [u, \bar{u},w]	$x,x,3/4$ [\bar{u},u,w]	$x,\bar{x},3/4$ [\bar{u},\bar{u},\bar{w}]	$\bar{x},x,3/4$ [u,u, \bar{w}]
4 c 4'..	$0,0,z$ [0,0,0]	$0,0,\bar{z}+1/2$ [0,0,0]	$0,0,\bar{z}$ [0,0,0]	$0,0,z+1/2$ [0,0,0]
2 b 4'/m..	$0,0,0$ [0,0,0]	$0,0,1/2$ [0,0,0]		
2 a 4'22'	$0,0,1/4$ [0,0,0]	$0,0,3/4$ [0,0,0]		

Symmetry of special projections

Along [001] 4mm1'	Along [100] $p_{2a} \cdot 2'mm'$ $a^* = c/2$	Along [110] $p2'mm'$ $a^* = c/2$
Origin at 0,0,z	Origin at x,0,0	Origin at x,x,0

$p4_2/mmc$

No. 41.1.217

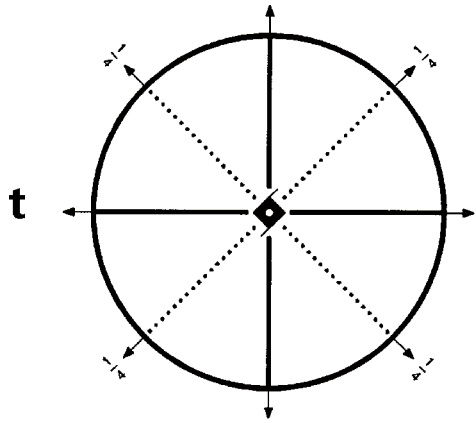

$4/mmm$

$p4_2/m2/m2/c$

Tetragonal

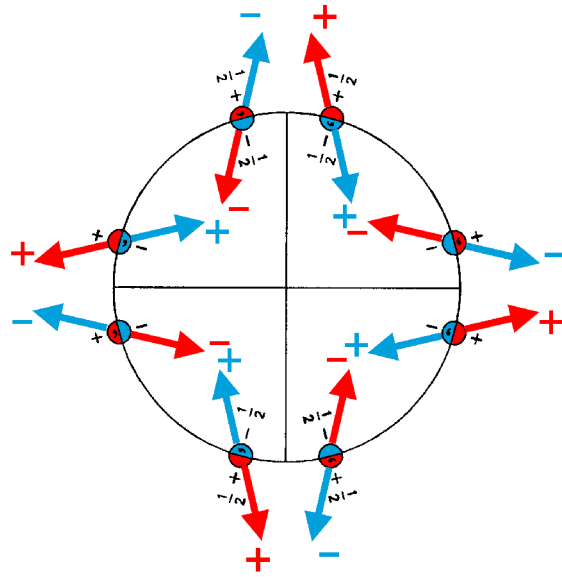

Origin at center (mmm) at $4_2/m2/mc$

Asymmetric unit $0 \leq x; 0 \leq y; 0 \leq z \leq 1/4$

Symmetry operations

- | | | | |
|--|---|---|---|
| (1) 1
(1 0,0,0) | (2) 2 0,0,z
(2 _z 0,0,0) | (3) 4 ⁺ (0,0,1/2) 0,0,z
(4 _z 0,0,1/2) | (4) 4 ⁻ (0,0,1/2) 0,0,z
(4 _z ⁻¹ 0,0,1/2) |
| (5) 2 0,y,0
(2 _y 0,0,0) | (6) 2 x,0,0
(2 _x 0,0,0) | (7) 2 x,x,1/4
(2 _{xy} 0,0,1/2) | (8) 2 x, \bar{x} ,1/4
(2 _{\bar{xy}} 0,0,1/2) |
| (9) $\bar{1}$ 0,0,0
($\bar{1}$ 0,0,0) | (10) m x,y,0
(m _z 0,0,0) | (11) $\bar{4}^+$ 0,0,z; 0,0,1/4
($\bar{4}_z^+$ 0,0,1/2) | (12) $\bar{4}^-$ 0,0,z; 0,0,1/4
($\bar{4}_z^-$ 0,0,1/2) |
| (13) m x,0,z
(m _y 0,0,0) | (14) m 0,y,z
(m _x 0,0,0) | (15) c (0,0,1/2) x, \bar{x} ,z
(m _{xy} 0,0,1/2) | (16) c (0,0,1/2) x,x,z
(m _{\bar{xy}} 0,0,1/2) |

Generators selected (1); $t(0,0,1)$; (2); (3); (5); (9)

Positions

	Coordinates			
Multiplicity, Wyckoff letter, Site symmetry				
16 i 1	(1) $x,y,z [u,v,w]$	(2) $\bar{x},\bar{y},z [\bar{u},\bar{v},w]$	(3) $\bar{y},x,z+1/2 [\bar{v},u,w]$	(4) $y,\bar{x},z+1/2 [v,\bar{u},w]$
	(5) $\bar{x},y,\bar{z} [\bar{u},v,\bar{w}]$	(6) $x,\bar{y},\bar{z} [u,\bar{v},\bar{w}]$	(7) $y,x,\bar{z}+1/2 [v,u,\bar{w}]$	(8) $\bar{y},\bar{x},\bar{z}+1/2 [\bar{v},\bar{u},\bar{w}]$
	(9) $\bar{x},\bar{y},\bar{z} [u,v,w]$	(10) $x,y,\bar{z} [\bar{u},\bar{v},w]$	(11) $y,\bar{x},\bar{z}+1/2 [\bar{v},u,w]$	(12) $\bar{y},x,\bar{z}+1/2 [v,\bar{u},w]$
	(13) $x,\bar{y},z [\bar{u},v,\bar{w}]$	(14) $\bar{x},y,z [u,\bar{v},\bar{w}]$	(15) $\bar{y},\bar{x},z+1/2 [v,u,\bar{w}]$	(16) $y,x,z+1/2 [\bar{v},\bar{u},\bar{w}]$
8 h .m.	$0,y,z [u,0,0]$	$0,\bar{y},z [\bar{u},0,0]$	$\bar{y},0,z+1/2 [0,u,0]$	$y,0,z+1/2 [0,\bar{u},0]$
	$0,y,\bar{z} [\bar{u},0,0]$	$0,\bar{y},\bar{z} [u,0,0]$	$y,0,\bar{z}+1/2 [0,u,0]$	$\bar{y},0,\bar{z}+1/2 [0,\bar{u},0]$
8 g m..	$x,y,0 [0,0,w]$	$\bar{x},\bar{y},0 [0,0,w]$	$\bar{y},x,1/2 [0,0,w]$	$y,\bar{x},1/2 [0,0,w]$
	$\bar{x},y,0 [0,0,\bar{w}]$	$x,\bar{y},0 [0,0,\bar{w}]$	$y,x,1/2 [0,0,\bar{w}]$	$\bar{y},\bar{x},1/2 [0,0,\bar{w}]$
8 f ..2	$x,x,1/4 [u,u,0]$	$\bar{x},\bar{x},1/4 [\bar{u},\bar{u},0]$	$\bar{x},x,3/4 [\bar{u},u,0]$	$x,\bar{x},3/4 [u,\bar{u},0]$
	$\bar{x},\bar{x},3/4 [u,u,0]$	$x,x,3/4 [\bar{u},\bar{u},0]$	$x,\bar{x},1/4 [\bar{u},u,0]$	$\bar{x},x,1/4 [u,\bar{u},0]$
4 e m2m.	$x,0,1/2 [0,0,0]$	$\bar{x},0,1/2 [0,0,0]$	$0,x,0 [0,0,0]$	$0,\bar{x},0 [0,0,0]$
4 d m2m.	$x,0,0 [0,0,0]$	$\bar{x},0,0 [0,0,0]$	$0,x,1/2 [0,0,0]$	$0,\bar{x},1/2 [0,0,0]$
4 c 2mm.	$0,0,z [0,0,0]$	$0,0,\bar{z} [0,0,0]$	$0,0,z+1/2 [0,0,0]$	$0,0,\bar{z}+1/2 [0,0,0]$
2 b $\bar{4}m2$	$0,0,1/4 [0,0,0]$	$0,0,3/4 [0,0,0]$		
2 a mmm.	$0,0,0 [0,0,0]$	$0,0,1/2 [0,0,0]$		

Continued

No. 41.1.217

$p4_2/mmc$

Symmetry of special projections

Along [001] $4mm1'$

Origin at 0,0,z

Along [100] $p2mm1'$

$a^* = c$

Origin at x,0,0

Along [110] $p_{2a^*}2'mm'$

$a^* = c/2$

Origin at x,x,0

$p4_2/mmc1'$

$4/mmm1'$

Tetragonal

No. 41.2.218

$p4_2/m2/m2/c1'$

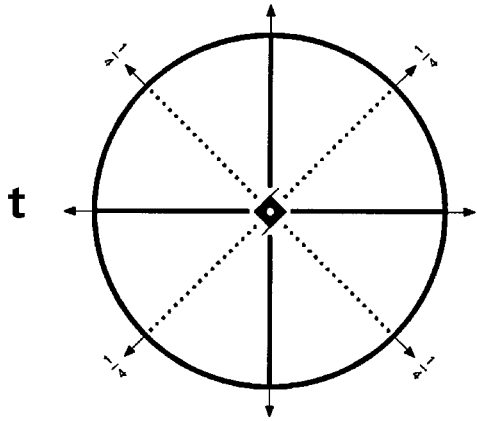

1'

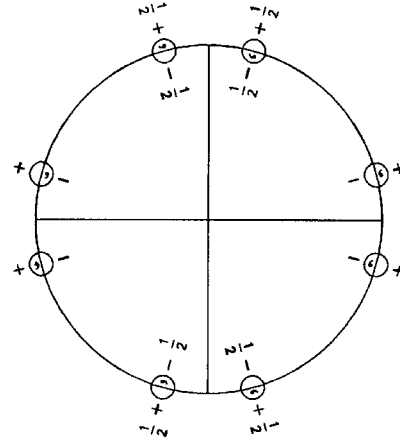

Origin at center ($mmm1'$) at $4_2/m2/mc1'$

Asymmetric unit $0 \leq x; 0 \leq y; 0 \leq z \leq 1/4$

Symmetry operations

For 1 + set

- | | | | |
|--|---|---|---|
| (1) 1
(1 0,0,0) | (2) 2 0,0,z
(2 _z 0,0,0) | (3) 4 ⁺ (0,0,1/2) 0,0,z
(4 _z 0,0,1/2) | (4) 4 ⁻ (0,0,1/2) 0,0,z
(4 _z ⁻¹ 0,0,1/2) |
| (5) 2 0,y,0
(2 _y 0,0,0) | (6) 2 x,0,0
(2 _x 0,0,0) | (7) 2 x,x,1/4
(2 _{xy} 0,0,1/2) | (8) 2 x,x̄,1/4
(2 _{xȳ} 0,0,1/2) |
| (9) $\bar{1}$ 0,0,0
($\bar{1}$ 0,0,0) | (10) m x,y,0
(m _z 0,0,0) | (11) $\bar{4}^+$ 0,0,z; 0,0,1/4
($\bar{4}_z^+$ 0,0,1/2) | (12) $\bar{4}^-$ 0,0,z; 0,0,1/4
($\bar{4}_z^-$ 0,0,1/2) |
| (13) m x,0,z
(m _y 0,0,0) | (14) m 0,y,z
(m _x 0,0,0) | (15) c (0,0,1/2) x,x̄,z
(m _{xy} 0,0,1/2) | (16) c (0,0,1/2) x,x,z
(m _{xȳ} 0,0,1/2) |

For 1' + set

- | | | | |
|---|---|--|--|
| (1) 1'
(1 0,0,0)' | (2) 2' 0,0,z
(2 _z 0,0,0)' | (3) 4 ⁺ ' (0,0,1/2) 0,0,z
(4 _z 0,0,1/2)' | (4) 4 ⁻ ' (0,0,1/2) 0,0,z
(4 _z ⁻¹ 0,0,1/2)' |
| (5) 2' 0,y,0
(2 _y 0,0,0)' | (6) 2' x,0,0
(2 _x 0,0,0)' | (7) 2' x,x,1/4
(2 _{xy} 0,0,1/2)' | (8) 2' x,x̄,1/4
(2 _{xȳ} 0,0,1/2)' |
| (9) $\bar{1}$ ' 0,0,0
($\bar{1}$ 0,0,0)' | (10) m' x,y,0
(m _z 0,0,0)' | (11) $\bar{4}^+$ ' 0,0,z; 0,0,1/4
($\bar{4}_z^+$ 0,0,1/2)' | (12) $\bar{4}^-$ ' 0,0,z; 0,0,1/4
($\bar{4}_z^-$ 0,0,1/2)' |
| (13) m' x,0,z
(m _y 0,0,0)' | (14) m' 0,y,z
(m _x 0,0,0)' | (15) c' (0,0,1/2) x,x̄,z
(m _{xy} 0,0,1/2)' | (16) c' (0,0,1/2) x,x,z
(m _{xȳ} 0,0,1/2)' |

Generators selected (1); $t(0,0,1)$; (2); (3); (5); (9); $1'$

Positions

Multiplicity, Wyckoff letter, Site symmetry	Coordinates			
		$1+$	$1'$	$+$
16 i $1\ 1'$	(1) x,y,z [0,0,0]	(2) \bar{x},\bar{y},z [0,0,0]	(3) $\bar{y},x,z+1/2$ [0,0,0]	(4) $y,\bar{x},z+1/2$ [0,0,0]
	(5) \bar{x},y,\bar{z} [0,0,0]	(6) x,\bar{y},\bar{z} [0,0,0]	(7) $y,x,\bar{z}+1/2$ [0,0,0]	(8) $\bar{y},\bar{x},\bar{z}+1/2$ [0,0,0]
	(9) \bar{x},\bar{y},\bar{z} [0,0,0]	(10) x,y,\bar{z} [0,0,0]	(11) $y,\bar{x},\bar{z}+1/2$ [0,0,0]	(12) $\bar{y},x,\bar{z}+1/2$ [0,0,0]
	(13) x,\bar{y},z [0,0,0]	(14) \bar{x},y,z [0,0,0]	(15) $\bar{y},\bar{x},z+1/2$ [0,0,0]	(16) $y,x,z+1/2$ [0,0,0]
8 h $.m.1'$	$0,y,z$ [0,0,0]	$0,\bar{y},z$ [0,0,0]	$\bar{y},0,z+1/2$ [0,0,0]	$y,0,z+1/2$ [0,0,0]
	$0,y,\bar{z}$ [0,0,0]	$0,\bar{y},\bar{z}$ [0,0,0]	$y,0,\bar{z}+1/2$ [0,0,0]	$\bar{y},0,\bar{z}+1/2$ [0,0,0]
8 g $m..1'$	$x,y,0$ [0,0,0]	$\bar{x},\bar{y},0$ [0,0,0]	$\bar{y},x,1/2$ [0,0,0]	$y,\bar{x},1/2$ [0,0,0]
	$\bar{x},y,0$ [0,0,0]	$x,\bar{y},0$ [0,0,0]	$y,x,1/2$ [0,0,0]	$\bar{y},\bar{x},1/2$ [0,0,0]
8 f $..21'$	$x,x,1/4$ [0,0,0]	$\bar{x},\bar{x},1/4$ [0,0,0]	$\bar{x},x,3/4$ [0,0,0]	$x,\bar{x},3/4$ [0,0,0]
	$\bar{x},\bar{x},3/4$ [0,0,0]	$x,x,3/4$ [0,0,0]	$x,\bar{x},1/4$ [0,0,0]	$\bar{x},x,1/4$ [0,0,0]
4 e $m2m.1'$	$x,0,1/2$ [0,0,0]	$\bar{x},0,1/2$ [0,0,0]	$0,x,0$ [0,0,0]	$0,\bar{x},0$ [0,0,0]
4 d $m2m.1'$	$x,0,0$ [0,0,0]	$\bar{x},0,0$ [0,0,0]	$0,x,1/2$ [0,0,0]	$0,\bar{x},1/2$ [0,0,0]
4 c $2mm.1'$	$0,0,z$ [0,0,0]	$0,0,\bar{z}$ [0,0,0]	$0,0,z+1/2$ [0,0,0]	$0,0,\bar{z}+1/2$ [0,0,0]
2 b $\bar{4}m2\ 1'$	$0,0,1/4$ [0,0,0]	$0,0,3/4$ [0,0,0]		
2 a $mmm.1'$	$0,0,0$ [0,0,0]	$0,0,1/2$ [0,0,0]		

Continued

No. 41.2.218

$p4_2/mmc1'$

Symmetry of special projections

Along [001] $4mm'$

Origin at 0,0,z

Along [100] $p2mm1'$

$a^* = c$

Origin at x,0,0

Along [110] $p2mm1'$

$a^* = c/2$

Origin at x,x,0

$p4_2/m'm'c'$

No. 41.3.219

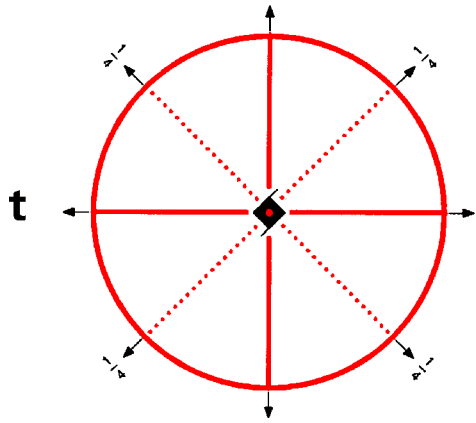

$4/m'm'm'$

$p4_2/m'2/m'2/c'$

Tetragonal

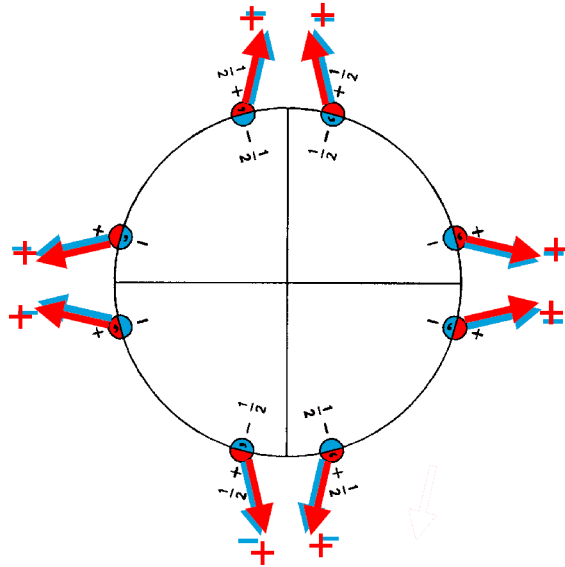

Origin at center ($m'm'm'$) at $4_2/m'2/m'c'$

Asymmetric unit $0 \leq x; 0 \leq y; 0 \leq z \leq 1/4$

Symmetry operations

- | | | | |
|---|---|---|---|
| (1) 1
(1 0,0,0) | (2) 2 0,0,z
(2 _z 0,0,0) | (3) 4 ⁺ (0,0,1/2) 0,0,z
(4 _z 0,0,1/2) | (4) 4 ⁻ (0,0,1/2) 0,0,z
(4 _z ⁻¹ 0,0,1/2) |
| (5) 2 0,y,0
(2 _y 0,0,0) | (6) 2 x,0,0
(2 _x 0,0,0) | (7) 2 x,x,1/4
(2 _{xy} 0,0,1/2) | (8) 2 x, \bar{x} ,1/4
(2 _{\bar{xy}} 0,0,1/2) |
| (9) $\bar{1}$ 0,0,0
($\bar{1}$ 0,0,0)' | (10) m' x,y,0
(m _z 0,0,0)' | (11) $\bar{4}$ ⁺ 0,0,z; 0,0,1/4
($\bar{4}$ _z 0,0,1/2)' | (12) $\bar{4}$ ⁻ 0,0,z; 0,0,1/4
($\bar{4}$ _z ⁻¹ 0,0,1/2)' |
| (13) m' x,0,z
(m _y 0,0,0)' | (14) m' 0,y,z
(m _x 0,0,0)' | (15) c' (0,0,1/2) x, \bar{x} ,z
(m _{xy} 0,0,1/2)' | (16) c' (0,0,1/2) x,x,z
(m _{\bar{xy}} 0,0,1/2)' |

Generators selected (1); $t(0,0,1)$; (2); (3); (5); (9)

Positions

	Coordinates			
Multiplicity, Wyckoff letter, Site symmetry				
16 i 1	(1) $x,y,z [u,v,w]$	(2) $\bar{x},\bar{y},z [\bar{u},\bar{v},w]$	(3) $\bar{y},x,z+1/2 [\bar{v},u,w]$	(4) $y,\bar{x},z+1/2 [v,\bar{u},w]$
	(5) $\bar{x},y,\bar{z} [\bar{u},v,\bar{w}]$	(6) $x,\bar{y},\bar{z} [u,\bar{v},\bar{w}]$	(7) $y,x,\bar{z}+1/2 [v,u,\bar{w}]$	(8) $\bar{y},\bar{x},\bar{z}+1/2 [\bar{v},\bar{u},\bar{w}]$
	(9) $\bar{x},\bar{y},\bar{z} [\bar{u},\bar{v},\bar{w}]$	(10) $x,y,\bar{z} [u,v,\bar{w}]$	(11) $y,\bar{x},\bar{z}+1/2 [v,\bar{u},\bar{w}]$	(12) $\bar{y},x,\bar{z}+1/2 [\bar{v},u,\bar{w}]$
	(13) $x,\bar{y},z [u,\bar{v},w]$	(14) $\bar{x},y,z [\bar{u},v,w]$	(15) $\bar{y},\bar{x},z+1/2 [\bar{v},\bar{u},w]$	(16) $y,x,z+1/2 [v,u,w]$
8 h .m'	$0,y,z [0,v,w]$	$0,\bar{y},z [0,\bar{v},w]$	$\bar{y},0,z+1/2 [\bar{v},0,w]$	$y,0,z+1/2 [v,0,w]$
	$0,y,\bar{z} [0,v,\bar{w}]$	$0,\bar{y},\bar{z} [0,\bar{v},\bar{w}]$	$y,0,\bar{z}+1/2 [v,0,\bar{w}]$	$\bar{y},0,\bar{z}+1/2 [\bar{v},0,\bar{w}]$
8 g m'..	$x,y,0 [u,v,0]$	$\bar{x},\bar{y},0 [\bar{u},\bar{v},0]$	$\bar{y},x,1/2 [\bar{v},u,0]$	$y,\bar{x},1/2 [v,\bar{u},0]$
	$\bar{x},y,0 [\bar{u},v,0]$	$x,\bar{y},0 [u,\bar{v},0]$	$y,x,1/2 [v,u,0]$	$\bar{y},\bar{x},1/2 [\bar{v},\bar{u},0]$
8 f ..2	$x,x,1/4 [u,u,0]$	$\bar{x},\bar{x},1/4 [\bar{u},\bar{u},0]$	$\bar{x},x,3/4 [\bar{u},u,0]$	$x,\bar{x},3/4 [u,\bar{u},0]$
	$\bar{x},\bar{x},3/4 [\bar{u},\bar{u},0]$	$x,x,3/4 [u,u,0]$	$x,\bar{x},1/4 [u,\bar{u},0]$	$\bar{x},x,1/4 [\bar{u},u,0]$
4 e m'2m'	$x,0,1/2 [u,0,0]$	$\bar{x},0,1/2 [\bar{u},0,0]$	$0,x,0 [0,u,0]$	$0,\bar{x},0 [0,\bar{u},0]$
4 d m'2m'	$x,0,0 [u,0,0]$	$\bar{x},0,0 [\bar{u},0,0]$	$0,x,1/2 [0,u,0]$	$0,\bar{x},1/2 [0,\bar{u},0]$
4 c 2m'm'	$0,0,z [0,0,w]$	$0,0,\bar{z} [0,0,\bar{w}]$	$0,0,z+1/2 [0,0,w]$	$0,0,\bar{z}+1/2 [0,0,\bar{w}]$
2 b $\bar{4}'m'2$	$0,0,1/4 [0,0,0]$	$0,0,3/4 [0,0,0]$		
2 a m'm'm'	$0,0,0 [0,0,0]$	$0,0,1/2 [0,0,0]$		

Continued

No. 41.3.219

$p4_2/m'm'c'$

Symmetry of special projections

Along [001] $4m'm'$

Origin at 0,0,z

Along [100] $p2m'm'$

$a^* = c$

Origin at x,0,0

Along [110] $p2m'm'$

$a^* = c/2$

Origin at x,x,0

$p4_2/mm'c'$

No. 41.4.220

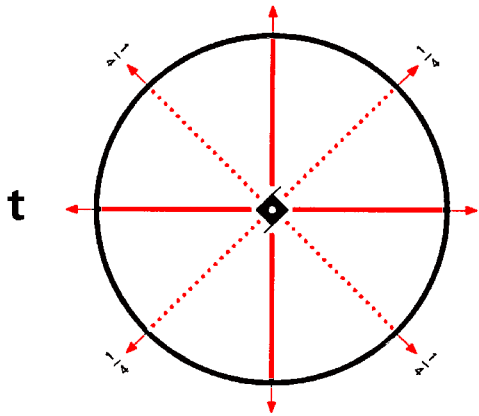

$4/mm'm'$

Tetragonal

$p4_2/m2'/m2'/c'$

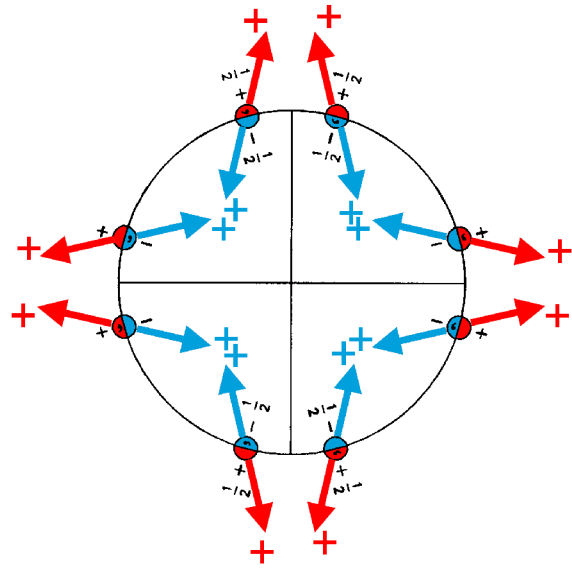

Origin at center ($m'm'm'$) at $4_2/m2'/m'c'$

Asymmetric unit $0 \leq x; 0 \leq y; 0 \leq z \leq 1/4$

Symmetry operations

- | | | | |
|---|---|--|--|
| (1) 1
(1 0,0,0) | (2) 2 _z 0,0,z
(2 _z 0,0,0) | (3) 4 ⁺ (0,0,1/2) 0,0,z
(4 _z ⁺ 0,0,1/2) | (4) 4 ⁻ (0,0,1/2) 0,0,z
(4 _z ⁻ 0,0,1/2) |
| (5) 2' _y 0,y,0
(2 _y ' 0,0,0)' | (6) 2' _x x,0,0
(2 _x ' 0,0,0)' | (7) 2' _{xy} x,x,1/4
(2 _{xy} ' 0,0,1/2)' | (8) 2' _{xy} x,̄x,1/4
(2 _{xy} ' 0,0,1/2)' |
| (9) $\bar{1}$ 0,0,0
($\bar{1}$ 0,0,0) | (10) m _z x,y,0
(m _z 0,0,0) | (11) $\bar{4}_z^+$ 0,0,z; 0,0,1/4
($\bar{4}_z^+$ 0,0,1/2) | (12) $\bar{4}_z^-$ 0,0,z; 0,0,1/4
($\bar{4}_z^-$ 0,0,1/2) |
| (13) m' _y x,0,z
(m _y ' 0,0,0)' | (14) m' _x 0,y,z
(m _x ' 0,0,0)' | (15) c' (0,0,1/2) x,̄x,z
(m _{xy} ' 0,0,1/2)' | (16) c' (0,0,1/2) x,x,z
(m _{xy} ' 0,0,1/2)' |

Generators selected (1); $t(0,0,1)$; (2); (3); (5); (9)

Positions

	Coordinates			
Multiplicity, Wyckoff letter, Site symmetry				
16 i 1	(1) x,y,z [u,v,w]	(2) \bar{x},\bar{y},z [\bar{u},\bar{v},w]	(3) $\bar{y},x,z+1/2$ [\bar{v},u,w]	(4) $y,\bar{x},z+1/2$ [v, \bar{u},w]
	(5) \bar{x},y,\bar{z} [u, \bar{v},w]	(6) x,\bar{y},\bar{z} [\bar{u},v,w]	(7) $y,x,\bar{z}+1/2$ [\bar{v},\bar{u},w]	(8) $\bar{y},\bar{x},\bar{z}+1/2$ [v,u,w]
	(9) \bar{x},\bar{y},\bar{z} [u,v,w]	(10) x,y,\bar{z} [\bar{u},\bar{v},w]	(11) $y,\bar{x},\bar{z}+1/2$ [\bar{v},u,w]	(12) $\bar{y},x,\bar{z}+1/2$ [v, \bar{u},w]
	(13) x,\bar{y},z [u, \bar{v},w]	(14) \bar{x},y,z [\bar{u},v,w]	(15) $\bar{y},\bar{x},z+1/2$ [\bar{v},\bar{u},w]	(16) $y,x,z+1/2$ [v,u,w]
8 h .m'	$0,y,z$ [0,v,w]	$0,\bar{y},z$ [0, \bar{v},w]	$\bar{y},0,z+1/2$ [$\bar{v},0,w$]	$y,0,z+1/2$ [v,0,w]
	$0,y,\bar{z}$ [0, \bar{v},w]	$0,\bar{y},\bar{z}$ [0,v,w]	$y,0,\bar{z}+1/2$ [$\bar{v},0,w$]	$\bar{y},0,\bar{z}+1/2$ [v,0,w]
8 g m..	$x,y,0$ [0,0,w]	$\bar{x},\bar{y},0$ [0,0,w]	$\bar{y},x,1/2$ [0,0,w]	$y,\bar{x},1/2$ [0,0,w]
	$\bar{x},y,0$ [0,0,w]	$x,\bar{y},0$ [0,0,w]	$y,x,1/2$ [0,0,w]	$\bar{y},\bar{x},1/2$ [0,0,w]
8 f ..2'	$x,x,1/4$ [u, \bar{u},w]	$\bar{x},\bar{x},1/4$ [\bar{u},u,w]	$\bar{x},x,3/4$ [u,u,w]	$x,\bar{x},3/4$ [\bar{u},\bar{u},w]
	$\bar{x},\bar{x},3/4$ [u, \bar{u},w]	$x,x,3/4$ [\bar{u},u,w]	$x,\bar{x},1/4$ [u,u,w]	$\bar{x},x,1/4$ [\bar{u},\bar{u},w]
4 e m2'm'	$x,0,1/2$ [0,0,w]	$\bar{x},0,1/2$ [0,0,w]	$0,x,0$ [0,0,w]	$0,\bar{x},0$ [0,0,w]
4 d m2'm'	$x,0,0$ [0,0,w]	$\bar{x},0,0$ [0,0,w]	$0,x,1/2$ [0,0,w]	$0,\bar{x},1/2$ [0,0,w]
4 c 2m'm'	$0,0,z$ [0,0,w]	$0,0,\bar{z}$ [0,0,w]	$0,0,z+1/2$ [0,0,w]	$0,0,\bar{z}+1/2$ [0,0,w]
2 b $\bar{4}m'2'$	$0,0,1/4$ [0,0,w]	$0,0,3/4$ [0,0,w]		
2 a mm'm'	$0,0,0$ [0,0,w]	$0,0,1/2$ [0,0,w]		

Continued

No. 41.4.220

$p4_2/m'm'c'$

Symmetry of special projections

Along [001] $4mm1'$

Origin at 0,0,z

Along [100] $p2'mm'$

$a^* = c$

Origin at x,0,0

Along [110] $p2'mm'$

$a^* = c/2$

Origin at x,x,0

$p4_2/m'mc$

No. 41.5.221

$4/m'mm$

$p4_2/m'2'/m2'/c$

Tetragonal

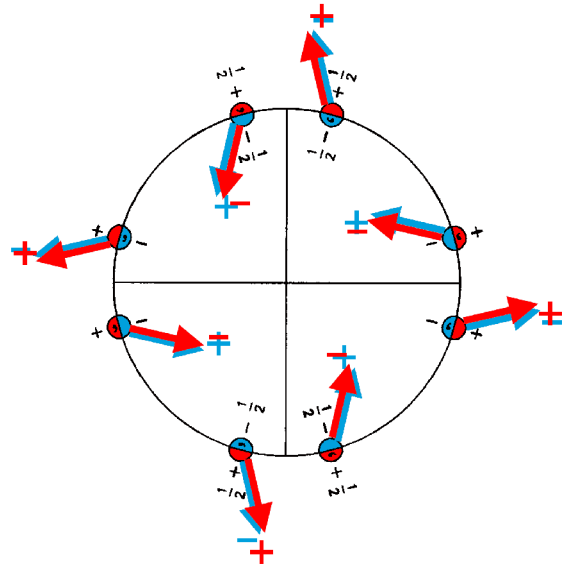
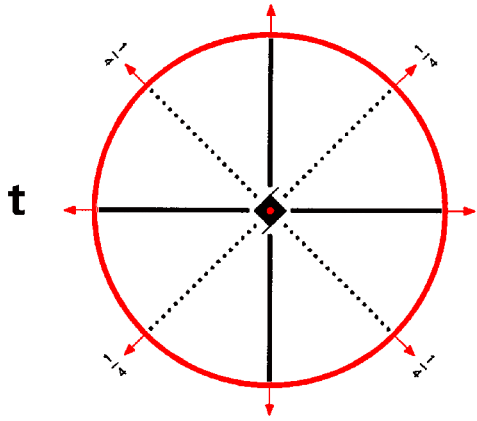

Origin at center (mmm') at $4_2/m'2'/mc$

Asymmetric unit $0 \leq x; 0 \leq y; 0 \leq z \leq 1/4$

Symmetry operations

- | | | | |
|---|--|---|---|
| (1) 1
(1 0,0,0) | (2) 2 _z 0,0,z
(2 _z 0,0,0) | (3) 4 ⁺ (0,0,1/2) 0,0,z
(4 _z 0,0,1/2) | (4) 4 ⁻ (0,0,1/2) 0,0,z
(4 _z ⁻¹ 0,0,1/2) |
| (5) 2' _y 0,y,0
(2 _y 0,0,0)' | (6) 2' _x x,0,0
(2 _x 0,0,0)' | (7) 2' _{xy} x,x,1/4
(2 _{xy} 0,0,1/2)' | (8) 2' _{xy} x,x̄,1/4
(2 _{xy} 0,0,1/2)' |
| (9) $\bar{1}$ 0,0,0
($\bar{1}$ 0,0,0)' | (10) m' _z x,y,0
(m _z 0,0,0)' | (11) $\bar{4}_z^+$ 0,0,z; 0,0,1/4
($\bar{4}_z^+$ 0,0,1/2)' | (12) $\bar{4}_z^-$ 0,0,z; 0,0,1/4
($\bar{4}_z^-$ 0,0,1/2)' |
| (13) m _y x,0,z
(m _y 0,0,0) | (14) m _x 0,y,z
(m _x 0,0,0) | (15) c (0,0,1/2) x,x̄,z
(m _{xy} 0,0,1/2) | (16) c (0,0,1/2) x,x,z
(m _{xy} 0,0,1/2) |

Generators selected (1); $t(0,0,1)$; (2); (3); (5); (9)

Positions

	Coordinates			
Multiplicity, Wyckoff letter, Site symmetry				
16 i 1	(1) $x,y,z [u,v,w]$	(2) $\bar{x},\bar{y},z [\bar{u},\bar{v},w]$	(3) $\bar{y},x,z+1/2 [\bar{v},u,w]$	(4) $y,\bar{x},z+1/2 [v,\bar{u},w]$
	(5) $\bar{x},y,\bar{z} [u,\bar{v},w]$	(6) $x,\bar{y},\bar{z} [\bar{u},v,w]$	(7) $y,x,\bar{z}+1/2 [\bar{v},\bar{u},w]$	(8) $\bar{y},\bar{x},\bar{z}+1/2 [v,u,w]$
	(9) $\bar{x},\bar{y},\bar{z} [\bar{u},\bar{v},\bar{w}]$	(10) $x,y,\bar{z} [u,v,\bar{w}]$	(11) $y,\bar{x},\bar{z}+1/2 [v,\bar{u},\bar{w}]$	(12) $\bar{y},x,\bar{z}+1/2 [\bar{v},u,\bar{w}]$
	(13) $x,\bar{y},z [\bar{u},v,\bar{w}]$	(14) $\bar{x},y,z [u,\bar{v},\bar{w}]$	(15) $\bar{y},\bar{x},z+1/2 [v,u,\bar{w}]$	(16) $y,x,z+1/2 [\bar{v},\bar{u},\bar{w}]$
8 h .m.	$0,y,z [u,0,0]$	$0,\bar{y},z [0,\bar{u},0]$	$\bar{y},0,z+1/2 [0,u,0]$	$y,0,z+1/2 [0,\bar{u},0]$
	$0,y,\bar{z} [u,0,0]$	$0,\bar{y},\bar{z} [0,\bar{u},0]$	$y,0,\bar{z}+1/2 [0,\bar{u},0]$	$\bar{y},0,\bar{z}+1/2 [0,u,0]$
8 g m'..	$x,y,0 [u,v,0]$	$\bar{x},\bar{y},0 [\bar{u},\bar{v},0]$	$\bar{y},x,1/2 [\bar{v},u,0]$	$y,\bar{x},1/2 [v,\bar{u},0]$
	$\bar{x},y,0 [u,\bar{v},0]$	$x,\bar{y},0 [\bar{u},v,0]$	$y,x,1/2 [\bar{v},\bar{u},0]$	$\bar{y},\bar{x},1/2 [v,u,0]$
8 f ..2'	$x,x,1/4 [u,\bar{u},w]$	$\bar{x},\bar{x},1/4 [\bar{u},u,w]$	$\bar{x},x,3/4 [u,u,w]$	$x,\bar{x},3/4 [\bar{u},\bar{u},w]$
	$\bar{x},\bar{x},3/4 [\bar{u},u,\bar{w}]$	$x,x,3/4 [u,\bar{u},\bar{w}]$	$x,\bar{x},1/4 [\bar{u},\bar{u},\bar{w}]$	$\bar{x},x,1/4 [u,u,\bar{w}]$
4 e m'2'm.	$x,0,1/2 [0,v,0]$	$\bar{x},0,1/2 [0,\bar{v},0]$	$0,x,0 [\bar{v},0,0]$	$0,\bar{x},0 [v,0,0]$
4 d m'2'm.	$x,0,0 [0,v,0]$	$\bar{x},0,0 [0,\bar{v},0]$	$0,x,1/2 [\bar{v},0,0]$	$0,\bar{x},1/2 [v,0,0]$
4 c 2mm.	$0,0,z [0,0,0]$	$0,0,\bar{z} [0,0,0]$	$0,0,z+1/2 [0,0,0]$	$0,0,\bar{z}+1/2 [0,0,0]$
2 b $\bar{4}'m2'$	$0,0,1/4 [0,0,0]$	$0,0,3/4 [0,0,0]$		
2 a m'mm.	$0,0,0 [0,0,0]$	$0,0,1/2 [0,0,0]$		

Continued

No. 41.5.221

$p4_2/m'mc$

Symmetry of special projections

Along [001] 4mm

Origin at 0,0,z

Along [100] $p2mm1'$

$a^* = c$

Origin at x,0,0

Along [110] $p_{2a^*}2m'm'$

$a^* = c/2$

Origin at x,x,0

$p4_2'/m'mc'$

$4'/m'mm'$

Tetragonal

No. 41.6.222

$p4_2'/m'2'/m2/c'$

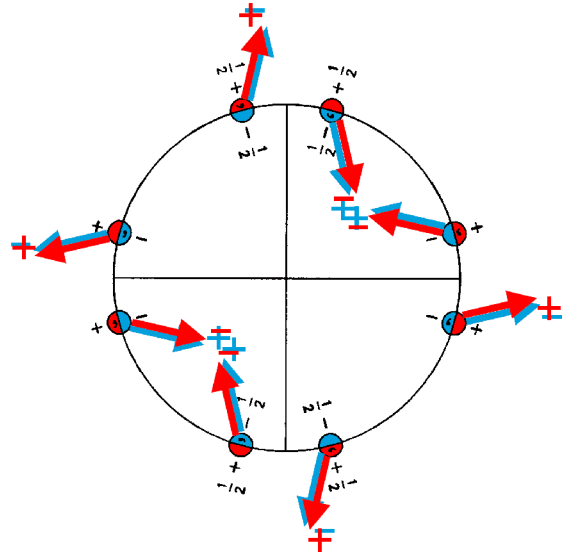
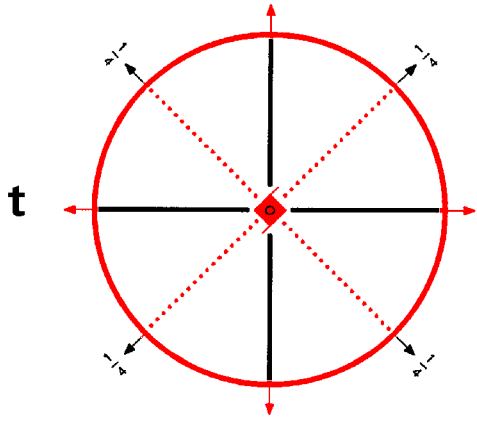

Origin at center (mmm') at $4_2'/m'2'/mc'$

Asymmetric unit $0 \leq x; 0 \leq y; 0 \leq z \leq 1/4$

Symmetry operations

- | | | | |
|--|---|---|---|
| (1) 1
(1 0,0,0) | (2) 2 0,0,z
(2 _z 0,0,0) | (3) 4 ⁺ (0,0,1/2) 0,0,z
(4 _z 0,0,1/2)' | (4) 4 ⁻ (0,0,1/2) 0,0,z
(4 _z ⁻¹ 0,0,1/2)' |
| (5) 2' 0,y,0
(2 _y 0,0,0)' | (6) 2' x,0,0
(2 _x 0,0,0)' | (7) 2 x,x,1/4
(2 _{xy} 0,0,1/2) | (8) 2 x,̄x,1/4
(2 _{̄xy} 0,0,1/2) |
| (9) ̄1 0,0,0
(̄1 0,0,0)' | (10) m' x,y,0
(m _z 0,0,0)' | (11) ̄4 ⁺ 0,0,z; 0,0,1/4
(̄4 _z 0,0,1/2) | (12) ̄4 ⁻ 0,0,z; 0,0,1/4
(̄4 _z ⁻¹ 0,0,1/2) |
| (13) m x,0,z
(m _y 0,0,0) | (14) m 0,y,z
(m _x 0,0,0) | (15) c' (0,0,1/2) x,̄x,z
(m _{xy} 0,0,1/2)' | (16) c' (0,0,1/2) x,x,z
(m _{̄xy} 0,0,1/2)' |

Generators selected (1); $t(0,0,1)$; (2); (3); (5); (9)

Positions

Multiplicity, Wyckoff letter, Site symmetry	Coordinates			
16 i 1	(1) $x,y,z [u,v,w]$	(2) $\bar{x},\bar{y},z [u,\bar{v},\bar{w}]$	(3) $\bar{y},x,z+1/2 [v,\bar{u},\bar{w}]$	(4) $y,\bar{x},z+1/2 [\bar{v},u,\bar{w}]$
	(5) $\bar{x},y,\bar{z} [u,\bar{v},w]$	(6) $x,\bar{y},\bar{z} [\bar{u},v,w]$	(7) $y,x,\bar{z}+1/2 [v,u,\bar{w}]$	(8) $\bar{y},\bar{x},\bar{z}+1/2 [\bar{v},\bar{u},\bar{w}]$
	(9) $\bar{x},\bar{y},\bar{z} [\bar{u},\bar{v},\bar{w}]$	(10) $x,y,\bar{z} [u,v,\bar{w}]$	(11) $y,\bar{x},\bar{z}+1/2 [\bar{v},u,w]$	(12) $\bar{y},x,\bar{z}+1/2 [v,\bar{u},w]$
	(13) $x,\bar{y},z [\bar{u},v,\bar{w}]$	(14) $\bar{x},y,z [u,\bar{v},\bar{w}]$	(15) $\bar{y},\bar{x},z+1/2 [\bar{v},\bar{u},w]$	(16) $y,x,z+1/2 [v,u,w]$
8 h .m.	$0,y,z [u,0,0]$	$0,\bar{y},z [\bar{u},0,0]$	$\bar{y},0,z+1/2 [0,\bar{u},0]$	$y,0,z+1/2 [0,u,0]$
	$0,y,\bar{z} [u,0,0]$	$0,\bar{y},\bar{z} [\bar{u},0,0]$	$y,0,\bar{z}+1/2 [0,u,0]$	$\bar{y},0,\bar{z}+1/2 [0,\bar{u},0]$
8 g m'..	$x,y,0 [u,v,0]$	$\bar{x},\bar{y},0 [\bar{u},\bar{v},0]$	$\bar{y},x,1/2 [v,\bar{u},0]$	$y,\bar{x},1/2 [\bar{v},u,0]$
	$\bar{x},y,0 [u,\bar{v},0]$	$x,\bar{y},0 [\bar{u},v,0]$	$y,x,1/2 [v,u,0]$	$\bar{y},\bar{x},1/2 [\bar{v},\bar{u},0]$
8 f ..2	$x,x,1/4 [u,u,0]$	$\bar{x},\bar{x},1/4 [\bar{u},\bar{u},0]$	$\bar{x},x,3/4 [u,\bar{u},0]$	$x,\bar{x},3/4 [\bar{u},u,0]$
	$\bar{x},\bar{x},3/4 [\bar{u},\bar{u},0]$	$x,x,3/4 [u,u,0]$	$x,\bar{x},1/4 [\bar{u},u,0]$	$\bar{x},x,1/4 [u,\bar{u},0]$
4 e m'2'm.	$x,0,1/2 [0,v,0]$	$\bar{x},0,1/2 [0,\bar{v},0]$	$0,x,0 [v,0,0]$	$0,\bar{x},0 [\bar{v},0,0]$
4 d m'2'm.	$x,0,0 [0,v,0]$	$\bar{x},0,0 [0,\bar{v},0]$	$0,x,1/2 [v,0,0]$	$0,\bar{x},1/2 [\bar{v},0,0]$
4 c 2mm.	$0,0,z [0,0,0]$	$0,0,\bar{z} [0,0,0]$	$0,0,z+1/2 [0,0,0]$	$0,0,\bar{z}+1/2 [0,0,0]$
2 b $\bar{4}m2$	$0,0,1/4 [0,0,0]$	$0,0,3/4 [0,0,0]$		
2 a m"mm.	$0,0,0 [0,0,0]$	$0,0,1/2 [0,0,0]$		

Continued

No. 41.6.222

$p4_2'/m'mc'$

Symmetry of special projections

Along [001] $4'mm'$

Origin at 0,0,z

Along [100] $p2mm1'$

$a^* = c$

Origin at x,0,0

Along [110] $p2m'm'$

$a^* = c/2$

Origin at x,x,0

$p4_2'/m'm'c$

No. 41.7.223

$4'/m'm'm$

$p4_2'/m'2/m'2'/c$

Tetragonal

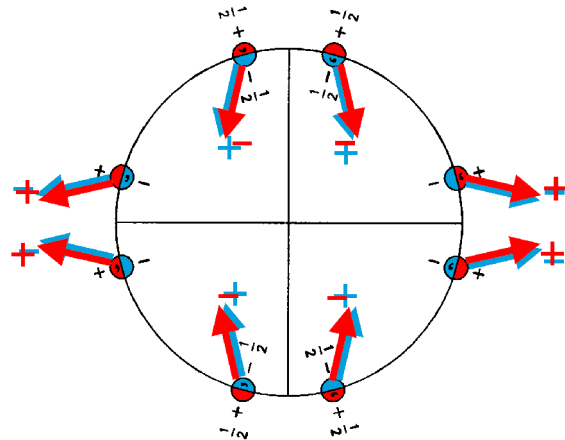
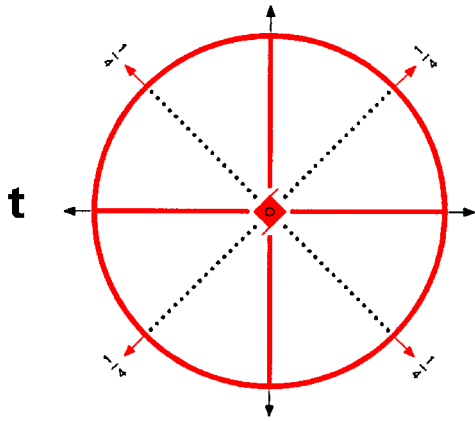

Origin at center ($m'm'm$) at $4_2'/m'2/m'c$

Asymmetric unit $0 \leq x; 0 \leq y; 0 \leq z \leq 1/4$

Symmetry operations

- | | | | |
|---|---------------------------------------|--|---|
| (1) 1
(1 0,0,0) | (2) 2 $0,0,z$
(2_z 0,0,0) | (3) 4^+ $(0,0,1/2)$ $0,0,z$
(4_z 0,0,1/2)' | (4) 4^- $(0,0,1/2)$ $0,0,z$
(4_z^{-1} 0,0,1/2)' |
| (5) 2 $0,y,0$
(2_y 0,0,0) | (6) 2 $x,0,0$
(2_x 0,0,0) | (7) $2'$ $x,x,1/4$
(2_{xy} 0,0,1/2)' | (8) $2'$ $x,\bar{x},1/4$
($2_{\bar{xy}}$ 0,0,1/2)' |
| (9) $\bar{1}$ $0,0,0$
($\bar{1}$ 0,0,0)' | (10) m' $x,y,0$
(m_z 0,0,0)' | (11) $\bar{4}^+$ $0,0,z; 0,0,1/4$
($\bar{4}_z$ 0,0,1/2) | (12) $\bar{4}^-$ $0,0,z; 0,0,1/4$
($\bar{4}_z^{-1}$ 0,0,1/2) |
| (13) m' $x,0,z$
(m_y 0,0,0)' | (14) m' $0,y,z$
(m_x 0,0,0)' | (15) c $(0,0,1/2)$ x,\bar{x},z
(m_{xy} 0,0,1/2) | (16) c $(0,0,1/2)$ x,x,z
($m_{\bar{xy}}$ 0,0,1/2) |

Generators selected (1); $t(0,0,1)$; (2); (3); (5); (9)

Positions

	Coordinates			
Multiplicity, Wyckoff letter, Site symmetry				
16 i 1	(1) x,y,z [u,v,w]	(2) \bar{x},\bar{y},z [\bar{u},\bar{v},w]	(3) $\bar{y},x,z+1/2$ [v,\bar{u},\bar{w}]	(4) $y,\bar{x},z+1/2$ [\bar{v},u,\bar{w}]
	(5) \bar{x},y,\bar{z} [\bar{u},v,\bar{w}]	(6) x,\bar{y},\bar{z} [u,\bar{v},\bar{w}]	(7) $y,x,\bar{z}+1/2$ [\bar{v},\bar{u},w]	(8) $\bar{y},\bar{x},\bar{z}+1/2$ [v,u,w]
	(9) \bar{x},\bar{y},\bar{z} [\bar{u},\bar{v},\bar{w}]	(10) x,y,\bar{z} [u,v,w]	(11) $y,\bar{x},\bar{z}+1/2$ [\bar{v},u,w]	(12) $\bar{y},x,\bar{z}+1/2$ [v,\bar{u},w]
	(13) x,\bar{y},z [u,\bar{v},w]	(14) \bar{x},y,z [\bar{u},v,w]	(15) $\bar{y},\bar{x},z+1/2$ [v,u,\bar{w}]	(16) $y,x,z+1/2$ [\bar{v},\bar{u},\bar{w}]
8 h .m'	$0,y,z$ [$0,v,w$]	$0,\bar{y},z$ [$0,\bar{v},w$]	$\bar{y},0,z+1/2$ [$v,0,\bar{w}$]	$y,0,z+1/2$ [$\bar{v},0,\bar{w}$]
	$0,y,\bar{z}$ [$0,v,\bar{w}$]	$0,\bar{y},\bar{z}$ [$0,\bar{v},\bar{w}$]	$y,0,\bar{z}+1/2$ [$\bar{v},0,w$]	$\bar{y},0,\bar{z}+1/2$ [$v,0,w$]
8 g m'..	$x,y,0$ [$u,v,0$]	$\bar{x},\bar{y},0$ [$\bar{u},\bar{v},0$]	$\bar{y},x,1/2$ [$v,\bar{u},0$]	$y,\bar{x},1/2$ [$\bar{v},u,0$]
	$\bar{x},y,0$ [$\bar{u},v,0$]	$x,\bar{y},0$ [$u,\bar{v},0$]	$y,x,1/2$ [$\bar{v},\bar{u},0$]	$\bar{y},\bar{x},1/2$ [$v,u,0$]
8 f ..2'	$x,x,1/4$ [u,\bar{u},w]	$\bar{x},\bar{x},1/4$ [\bar{u},u,w]	$\bar{x},x,3/4$ [\bar{u},\bar{u},\bar{w}]	$x,\bar{x},3/4$ [u,u,\bar{w}]
	$\bar{x},\bar{x},3/4$ [\bar{u},\bar{u},\bar{w}]	$x,x,3/4$ [u,u,\bar{w}]	$x,\bar{x},1/4$ [u,\bar{u},w]	$\bar{x},x,1/4$ [\bar{u},u,w]
4 e m'2m'	$x,0,1/2$ [$u,0,0$]	$\bar{x},0,1/2$ [$\bar{u},0,0$]	$0,x,0$ [$0,\bar{u},0$]	$0,\bar{x},0$ [$0,u,0$]
4 d m'2m'	$x,0,0$ [$u,0,0$]	$\bar{x},0,0$ [$\bar{u},0,0$]	$0,x,1/2$ [$0,\bar{u},0$]	$0,\bar{x},1/2$ [$0,u,0$]
4 c 2m'm'	$0,0,z$ [$0,0,w$]	$0,0,\bar{z}$ [$0,0,\bar{w}$]	$0,0,z+1/2$ [$0,0,\bar{w}$]	$0,0,\bar{z}+1/2$ [$0,0,w$]
2 b $\bar{4}m'2'$	$0,0,1/4$ [$0,0,w$]	$0,0,3/4$ [$0,0,\bar{w}$]		
2 a m'm'm'	$0,0,0$ [$0,0,0$]	$0,0,1/2$ [$0,0,0$]		

Continued

No. 41.7.223

$p4_2'/m'm'c$

Symmetry of special projections

Along [001] $4'm'm'$

Origin at 0,0,z

Along [100] $p2m'm'$

$a^* = c$

Origin at x,0,0

Along [110] $p_{2a^*}2m'm'$

$a^* = c/2$

Origin at x,x,0

$p4_2'/mmc'$

No. 41.8.224

$4'/mmm'$

$p4_2'/m2/m2'/c'$

Tetragonal

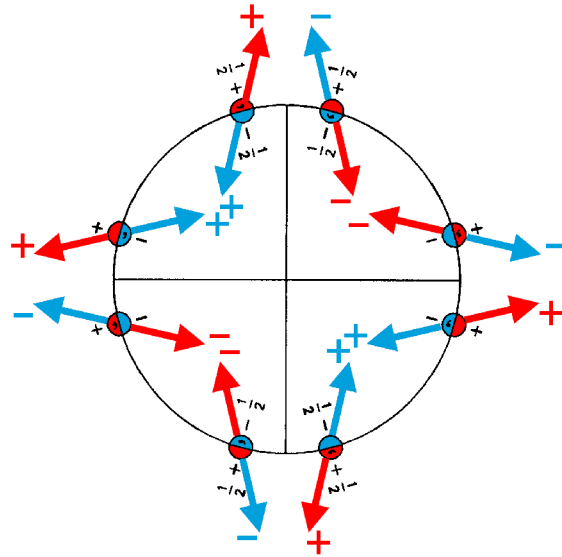
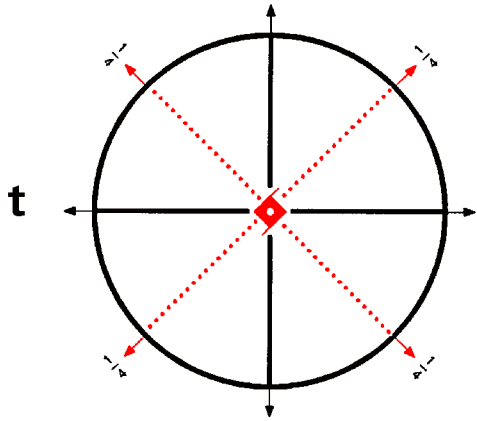

Origin at center (mmm) at $4_2'/m2/mc'$

Asymmetric unit $0 \leq x; 0 \leq y; 0 \leq z \leq 1/4$

Symmetry operations

- | | | | |
|--|---|--|--|
| (1) 1
(1 0,0,0) | (2) 2 0,0,z
(2 _z 0,0,0) | (3) 4 ⁺ (0,0,1/2) 0,0,z
(4 _z 0,0,1/2)' | (4) 4 ⁻ (0,0,1/2) 0,0,z
(4 _z ⁻¹ 0,0,1/2)' |
| (5) 2 0,y,0
(2 _y 0,0,0) | (6) 2 x,0,0
(2 _x 0,0,0) | (7) 2' x,x,1/4
(2 _{xy} 0,0,1/2)' | (8) 2' x,x̄,1/4
(2 _{x̄y} 0,0,1/2)' |
| (9) $\bar{1}$ 0,0,0
($\bar{1}$ 0,0,0) | (10) m x,y,0
(m _z 0,0,0) | (11) $\bar{4}^+$ 0,0,z; 0,0,1/4
($\bar{4}_z^+$ 0,0,1/2)' | (12) $\bar{4}^-$ 0,0,z; 0,0,1/4
($\bar{4}_z^-$ 0,0,1/2)' |
| (13) m x,0,z
(m _y 0,0,0) | (14) m 0,y,z
(m _x 0,0,0) | (15) c' (0,0,1/2) x,x̄,z
(m _{xy} 0,0,1/2)' | (16) c' (0,0,1/2) x,x,z
(m _{x̄y} 0,0,1/2)' |

Generators selected (1); $t(0,0,1)$; (2); (3); (5); (9)

Positions

	Coordinates			
Multiplicity, Wyckoff letter, Site symmetry				
16 i 1	(1) $x,y,z [u,v,w]$	(2) $\bar{x},\bar{y},z [\bar{u},\bar{v},w]$	(3) $\bar{y},x,z+1/2 [v,\bar{u},\bar{w}]$	(4) $y,\bar{x},z+1/2 [\bar{v},u,\bar{w}]$
	(5) $\bar{x},y,\bar{z} [\bar{u},v,\bar{w}]$	(6) $x,\bar{y},\bar{z} [u,\bar{v},\bar{w}]$	(7) $y,x,\bar{z}+1/2 [\bar{v},\bar{u},w]$	(8) $\bar{y},\bar{x},\bar{z}+1/2 [v,u,w]$
	(9) $\bar{x},\bar{y},\bar{z} [u,v,w]$	(10) $x,y,\bar{z} [\bar{u},\bar{v},w]$	(11) $y,\bar{x},\bar{z}+1/2 [v,\bar{u},\bar{w}]$	(12) $\bar{y},x,\bar{z}+1/2 [\bar{v},u,\bar{w}]$
	(13) $x,\bar{y},z [\bar{u},v,\bar{w}]$	(14) $\bar{x},y,z [u,\bar{v},\bar{w}]$	(15) $\bar{y},\bar{x},z+1/2 [\bar{v},\bar{u},w]$	(16) $y,x,z+1/2 [v,u,w]$
8 h .m.	$0,y,z [u,0,0]$	$0,\bar{y},z [\bar{u},0,0]$	$\bar{y},0,z+1/2 [0,\bar{u},0]$	$y,0,z+1/2 [0,u,0]$
	$0,y,\bar{z} [\bar{u},0,0]$	$0,\bar{y},\bar{z} [u,0,0]$	$y,0,\bar{z}+1/2 [0,\bar{u},0]$	$\bar{y},0,\bar{z}+1/2 [0,u,0]$
8 g m..	$x,y,0 [0,0,w]$	$\bar{x},\bar{y},0 [0,0,w]$	$\bar{y},x,1/2 [0,0,\bar{w}]$	$y,\bar{x},1/2 [0,0,\bar{w}]$
	$\bar{x},y,0 [0,0,\bar{w}]$	$x,\bar{y},0 [0,0,\bar{w}]$	$y,x,1/2 [0,0,w]$	$\bar{y},\bar{x},1/2 [0,0,w]$
8 f ..2'	$x,x,1/4 [u,\bar{u},w]$	$\bar{x},\bar{x},1/4 [\bar{u},u,w]$	$\bar{x},x,3/4 [\bar{u},\bar{u},\bar{w}]$	$x,\bar{x},3/4 [u,u,\bar{w}]$
	$\bar{x},\bar{x},3/4 [u,\bar{u},w]$	$x,x,3/4 [\bar{u},u,w]$	$x,\bar{x},1/4 [\bar{u},\bar{u},\bar{w}]$	$\bar{x},x,1/4 [u,u,\bar{w}]$
4 e m2m.	$x,0,1/2 [0,0,0]$	$\bar{x},0,1/2 [0,0,0]$	$0,x,0 [0,0,0]$	$0,\bar{x},0 [0,0,0]$
4 d m2m.	$x,0,0 [0,0,0]$	$\bar{x},0,0 [0,0,0]$	$0,x,1/2 [0,0,0]$	$0,\bar{x},1/2 [0,0,0]$
4 c 2mm.	$0,0,z [0,0,0]$	$0,0,\bar{z} [0,0,0]$	$0,0,z+1/2 [0,0,0]$	$0,0,\bar{z}+1/2 [0,0,0]$
2 b $\bar{4}'m2'$	$0,0,1/4 [0,0,0]$	$0,0,3/4 [0,0,0]$		
2 a mmm.	$0,0,0 [0,0,0]$	$0,0,1/2 [0,0,0]$		

Continued

No. 41.8.224

$p4_2'/mmc'$

Symmetry of special projections

Along [001] $4'mm'$

Origin at 0,0,z

Along [100] $p2mm1'$

$a^* = c$

Origin at x,0,0

Along [110] $p2'mm'$

$a^* = c/2$

Origin at x,x,0

$p4_2'/mm'c$

No. 41.9.225

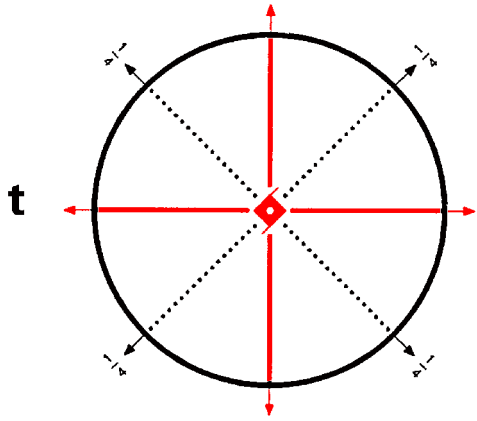

$4'/mm'm$

$p4_2'/m2'/m'2'/c$

Tetragonal

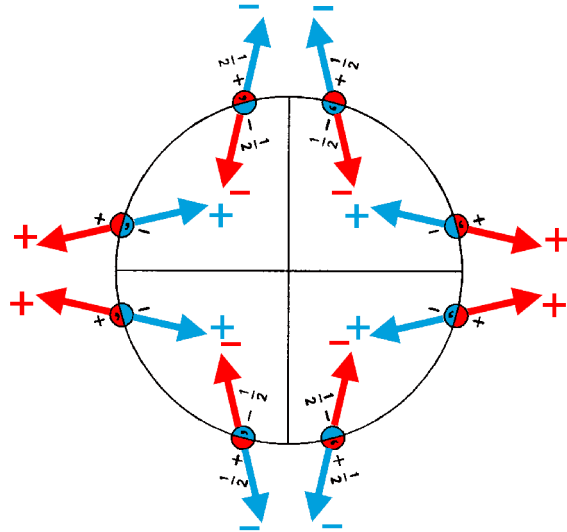

Origin at center ($m'm'm$) at $4_2'/m2'/m'c$

Asymmetric unit $0 \leq x; 0 \leq y; 0 \leq z \leq 1/4$

Symmetry operations

- | | | | |
|--|---|---|---|
| (1) 1
(1 0,0,0) | (2) 2 0,0,z
(2 _z 0,0,0) | (3) 4 ⁺ (0,0,1/2) 0,0,z
(4 _z 0,0,1/2)' | (4) 4 ⁻ (0,0,1/2) 0,0,z
(4 _z ⁻¹ 0,0,1/2)' |
| (5) 2' 0,y,0
(2 _y 0,0,0)' | (6) 2' x,0,0
(2 _x 0,0,0)' | (7) 2 x,x,1/4
(2 _{xy} 0,0,1/2) | (8) 2 x,x̄,1/4
(2 _{xy} 0,0,1/2) |
| (9) $\bar{1}$ 0,0,0
($\bar{1}$ 0,0,0) | (10) m x,y,0
(m _z 0,0,0) | (11) $\bar{4}$ ⁺ 0,0,z; 0,0,1/4
($\bar{4}$ _z 0,0,1/2)' | (12) $\bar{4}$ ⁻ 0,0,z; 0,0,1/4
($\bar{4}$ _z ⁻¹ 0,0,1/2)' |
| (13) m' x,0,z
(m _y 0,0,0)' | (14) m' 0,y,z
(m _x 0,0,0)' | (15) c (0,0,1/2) x,x̄,z
(m _{xy} 0,0,1/2) | (16) c (0,0,1/2) x,x,z
(m _{xy} 0,0,1/2) |

Generators selected (1); $t(0,0,1)$; (2); (3); (5); (9)

Positions

Multiplicity, Wyckoff letter, Site symmetry	Coordinates			
	(1) x,y,z [u,v,w]	(2) \bar{x},\bar{y},z [\bar{u},\bar{v},w]	(3) $\bar{y},x,z+1/2$ [v, \bar{u},\bar{w}]	(4) $y,\bar{x},z+1/2$ [\bar{v},u,\bar{w}]
16 i 1	(5) \bar{x},y,\bar{z} [u, \bar{v},w]	(6) x,\bar{y},\bar{z} [\bar{u},v,w]	(7) $y,x,\bar{z}+1/2$ [v,u, \bar{w}]	(8) $\bar{y},\bar{x},\bar{z}+1/2$ [\bar{v},\bar{u},\bar{w}]
	(9) \bar{x},\bar{y},\bar{z} [u,v,w]	(10) x,y,\bar{z} [\bar{u},\bar{v},w]	(11) $y,\bar{x},\bar{z}+1/2$ [v, \bar{u},\bar{w}]	(12) $\bar{y},x,\bar{z}+1/2$ [\bar{v},u,\bar{w}]
	(13) x,\bar{y},z [u, \bar{v},w]	(14) \bar{x},y,z [\bar{u},v,w]	(15) $\bar{y},\bar{x},z+1/2$ [v,u, \bar{w}]	(16) $y,x,z+1/2$ [\bar{v},\bar{u},\bar{w}]
8 h m' .	$0,y,z$ [0,v,w]	$0,\bar{y},z$ [0, \bar{v},w]	$\bar{y},0,z+1/2$ [v,0, \bar{w}]	$y,0,z+1/2$ [$\bar{v},0,\bar{w}$]
	$0,y,\bar{z}$ [0, \bar{v},w]	$0,\bar{y},\bar{z}$ [0,v,w]	$y,0,\bar{z}+1/2$ [v,0, \bar{w}]	$\bar{y},0,\bar{z}+1/2$ [$\bar{v},0,\bar{w}$]
8 g $m..$	$x,y,0$ [0,0,w]	$\bar{x},\bar{y},0$ [0,0,w]	$\bar{y},x,1/2$ [0,0, \bar{w}]	$y,\bar{x},1/2$ [0,0, \bar{w}]
	$\bar{x},y,0$ [0,0,w]	$x,\bar{y},0$ [0,0,w]	$y,x,1/2$ [0,0, \bar{w}]	$\bar{y},\bar{x},1/2$ [0,0, \bar{w}]
8 f $.2$	$x,x,1/4$ [u,u,0]	$\bar{x},\bar{x},1/4$ [$\bar{u},\bar{u},0$]	$\bar{x},x,3/4$ [u, $\bar{u},0$]	$x,\bar{x},3/4$ [$\bar{u},u,0$]
	$\bar{x},\bar{x},3/4$ [u,u,0]	$x,x,3/4$ [$\bar{u},\bar{u},0$]	$x,\bar{x},1/4$ [u, $\bar{u},0$]	$\bar{x},x,1/4$ [$\bar{u},u,0$]
4 e $m2'm'$.	$x,0,1/2$ [0,0,w]	$\bar{x},0,1/2$ [0,0,w]	$0,x,0$ [0,0, \bar{w}]	$0,\bar{x},0$ [0,0, \bar{w}]
4 d $m2'm'$.	$x,0,0$ [0,0,w]	$\bar{x},0,0$ [0,0,w]	$0,x,1/2$ [0,0, \bar{w}]	$0,\bar{x},1/2$ [0,0, \bar{w}]
4 c $2m'm'$.	$0,0,z$ [0,0,w]	$0,0,\bar{z}$ [0,0,w]	$0,0,z+1/2$ [0,0, \bar{w}]	$0,0,\bar{z}+1/2$ [0,0, \bar{w}]
2 b $\bar{4}'m'2$	$0,0,1/4$ [0,0,0]	$0,0,3/4$ [0,0,0]		
2 a $mm'm'$.	$0,0,0$ [0,0,w]	$0,0,1/2$ [0,0, \bar{w}]		

Continued

No. 41.9.225

$p4_2'/mm'c$

Symmetry of special projections

Along [001] $4mm1'$

Origin at 0,0,z

Along [100] $p2'mm'$

$a^* = c$

Origin at x,0,0

Along [110] $p_{2a^*}2'mm'$

$a^* = c/2$

Origin at x,x,0

$p3$

3

Trigonal

No. 42.1.226

$p3$

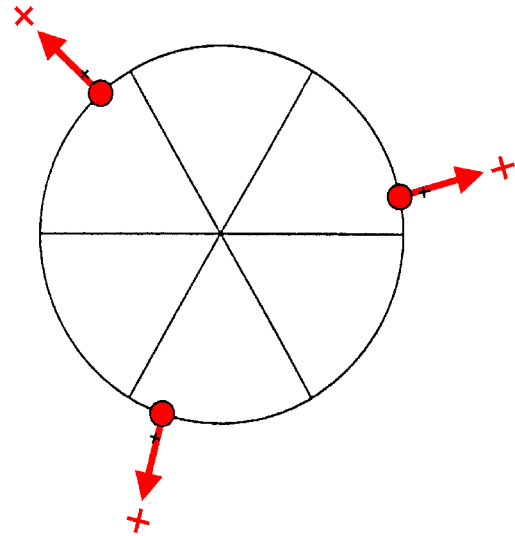
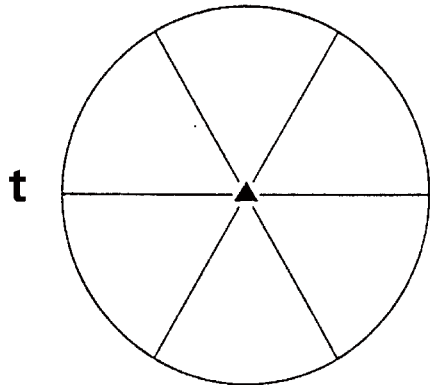

Origin on 3

Asymmetric unit $0 \leq x$; $0 \leq y$; $0 \leq z \leq 1$

Symmetry operations

(1) 1
(1|0,0,0)

(2) 3^+ 0,0,z
(3_z |0,0,0)

(3) 3^- 0,0,z
(3_z^{-1} |0,0,0)

Generators selected (1); $t(0,0,1)$; (2)

Positions

		Coordinates		
		Multiplicity, Wyckoff letter, Site symmetry		
3	b 1	(1) x,y,z [u,v,w]	(2) $\bar{y},x-y,z$ [$\bar{v},u-v,w$]	(3) $\bar{x}+y,\bar{x},z$ [$\bar{u}+v,\bar{u},w$]
1	a 3..	$0,0,z$ [$0,0,w$]		

Symmetry of special projections

Along [001] 3	Along [100] $p1$ $a^* = c$	Along [210] $p1$ $a^* = c$
Origin at $0,0,z$	Origin at $x,0,0$	Origin at $x,x/2,0$

$p31'$

$31'$

Trigonal

No. 42.2.227

$p31'$

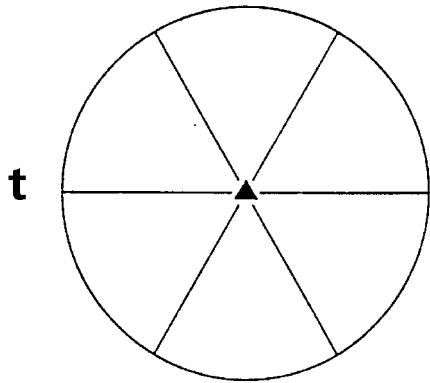

1'

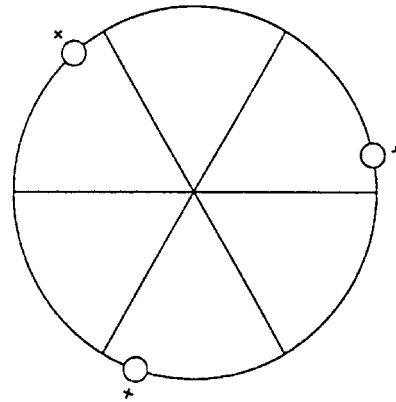

Origin on $31'$

Asymmetric unit $0 \leq x; 0 \leq y; 0 \leq z \leq 1$

Symmetry operations

For $1 +$ set

(1) 1

$(1|0,0,0)$

(2) 3^+ $0,0,z$

$(3_z|0,0,0)$

(3) 3^- $0,0,z$

$(3_z^{-1}|0,0,0)$

For $1' +$ set

(1) $1'$

$(1|0,0,0)'$

(2) $3^{+'}$ $0,0,z$

$(3_z|0,0,0)'$

(3) $3^{-'}$ $0,0,z$

$(3_z^{-1}|0,0,0)'$

Generators selected (1); $t(0,0,1)$; (2); $1'$

Positions

		Coordinates		
Multiplicity, Wyckoff letter, Site symmetry				
		1+	1' +	
3	b 11'	(1) x,y,z [0,0,0]	(2) $\bar{y},x-y,z$ [0,0,0]	(3) $\bar{x}+y,\bar{x},z$ [0,0,0]
1	a 3..1'	0,0,z [0,0,0]		

Symmetry of special projections

Along [001] $31'$	Along [100] $p11'$	Along [210] $p11'$
	$a^* = c$	$a^* = c$
Origin at 0,0,z	Origin at x,0,0	Origin at x,x/2,0

$\rho_{2c}3$

No. 42.3.228

$31'$

$\rho_{2c}3$

Trigonal

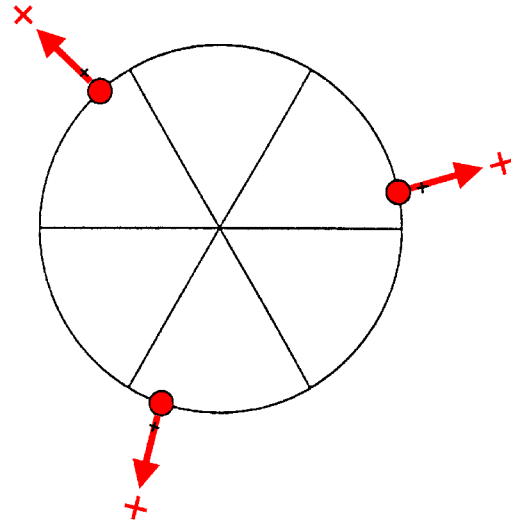
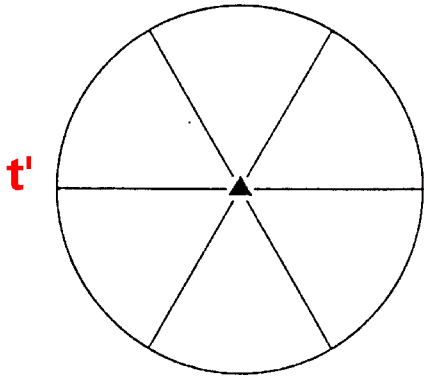

Origin on 3

Asymmetric unit $0 \leq x; 0 \leq y; 0 \leq z \leq 1$

Symmetry operations

For (0,0,0) + set
 (1) 1
 (1|0,0,0)

(2) 3^+ 0,0,z
 (3_z |0,0,0)

(3) 3^- 0,0,z
 (3_z^{-1} |0,0,0)

For (0,0,1)' + set
 (1) t' (0,0,1)
 (1|0,0,1)'

(2) $3^{+'}$ (0,0,1) 0,0,z
 (3_z |0,0,1)'

(3) $3^{-'}$ (0,0,1) 0,0,z
 (3_z^{-1} |0,0,1)'

Generators selected (1); $t(0,0,1)'$; (2)

Positions

		Coordinates		
Multiplicity, Wyckoff letter, Site symmetry		(0,0,0)+	(0,0,1)'+	
3	b 1	(1) x,y,z [u,v,w]	(2) $\bar{y},x-y,z$ [$\bar{v},u-v,w$]	(3) $\bar{x}+y,\bar{x},z$ [$\bar{u}+v,\bar{u},w$]
1	a 3..	0,0,z [0,0,w]		

Symmetry of special projections

Along [001] $31'$	Along [100] $p_{2a^*}1$ $a^* = c$	Along [210] $p_{2a^*}1$ $a^* = c$
Origin at 0,0,z	Origin at x,0,0	Origin at x,x/2,0

$p3_1$

No. 43.1.229

3

$p3_1$

Trigonal

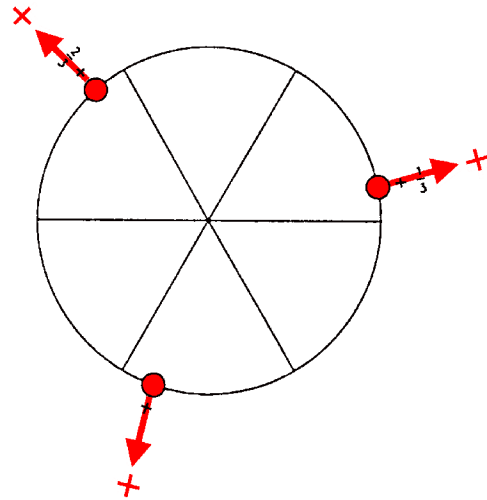
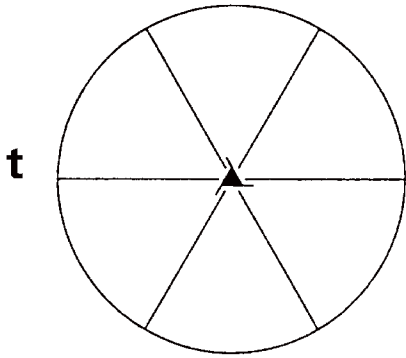

Origin on 3_1

Asymmetric unit $0 \leq x; 0 \leq y; 0 \leq z \leq 1$

Symmetry operations

(1) 1
(1|0,0,0)

(2) 3^+ (0,0,1/3) 0,0,z
(3_z |0,0,1/3)

(3) 3^- (0,0,2/3) 0,0,z
(3_z^{-1} |0,0,2/3)

Continued

No. 43.1.229

$p3_1$

Generators selected (1); $t(0,0,1)$; (2)

Positions

	Coordinates		
Multiplicity, Wyckoff letter, Site symmetry			
3 a 1	(1) x,y,z [u,v,w]	(2) $\bar{y},x-y,z+1/3$ [$\bar{v},u-v,w$]	(3) $\bar{x}+y,\bar{x},z+2/3$ [$\bar{u}+v,\bar{u},w$]

Symmetry of special projections

Along [001] 3	Along [100] $p1$ $a^* = c$	Along [210] $p1$ $a^* = c$
Origin at 0,0,z	Origin at x,0,0	Origin at x,x/2,0

$p3_11'$

No. 43.2.230

$31'$

$p3_11'$

Trigonal

1'

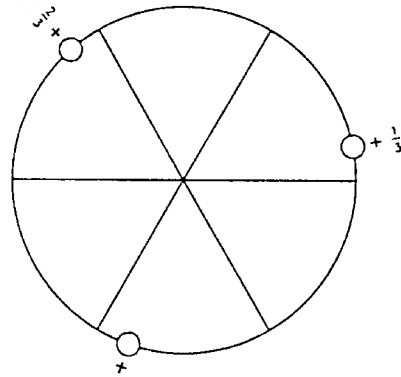
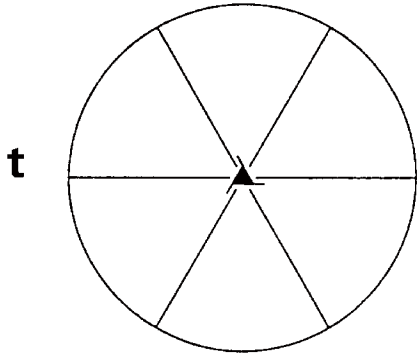

Origin on $31'$

Asymmetric unit $0 \leq x; 0 \leq y; 0 \leq z \leq 1$

Symmetry operations

For $1 +$ set

(1) 1
($1|0,0,0$)

(2) 3^+ ($0,0,1/3$) $0,0,z$
($3_z|0,0,1/3$)

(3) 3^- ($0,0,2/3$) $0,0,z$
($3_z^{-1}|0,0,2/3$)

For $1' +$ set

(1) $1'$
($1|0,0,0$)'

(2) $3^{+'}$ ($0,0,1/3$) $0,0,z$
($3_z|0,0,1/3$)'

(3) $3^{-'}$ ($0,0,2/3$) $0,0,z$
($3_z^{-1}|0,0,2/3$)'

Continued

No. 43.2.230

$p3_11'$

Generators selected (1); $t(0,0,1)$; (2); $1'$

Positions

Multiplicity, Wyckoff letter, Site symmetry	Coordinates		
		1+	1' +
3 a $11'$	(1) x,y,z [0,0,0]	(2) $\bar{y},x-y,z+1/3$ [0,0,0]	(3) $\bar{x}+y,\bar{x},z+2/3$ [0,0,0]

Symmetry of special projections

Along [001] $31'$	Along [100] $p11'$	Along [210] $p11'$
Origin at 0,0,z	$a^* = c$ Origin at x,0,0	$a^* = c$ Origin at x,x/2,0

$\rho_{2c}3_2$

No. 43.3.231

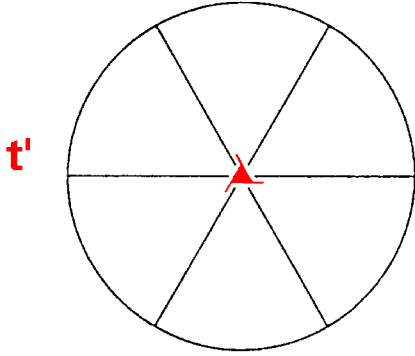

$3_1'$

$\rho_{2c}3_2$

Trigonal

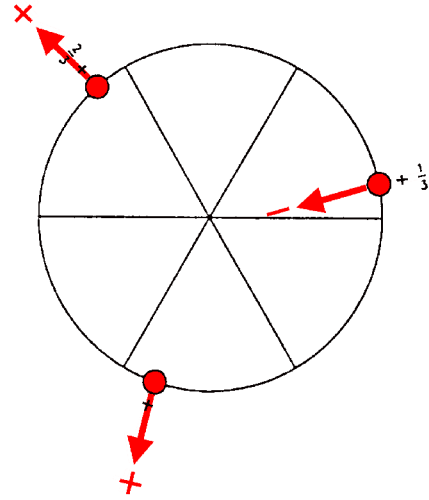

Origin on $3_1'$

Asymmetric unit $0 \leq x; 0 \leq y; 0 \leq z \leq 1$

Symmetry operations

For $(0,0,0) +$ set

(1) 1

(1|0,0,0)

(2) 3^{+} (0,0,1/3) 0,0,z
(3_z^{-1} |0,0,1/3)'

(3) 3^{-} (0,0,2/3) 0,0,z
(3_z^{-1} |0,0,2/3)

For $(0,0,0)' +$ set

(1) t' (0,0,1)

(1|0,0,1)'

(2) 3^{+} (0,0,4/3) 0,0,z
(3_z^{-1} |0,0,4/3)

(3) 3^{-} (0,0,5/3) 0,0,z
(3_z^{-1} |0,0,5/3)'

Continued

No. 43.3.231

$P_{2c} 3_2$

Generators selected (1); $t(0,0,1)'$; (2)

Positions

Multiplicity, Wyckoff letter, Site symmetry	Coordinates		
	(0,0,0)+	(0,0,1)' +	
3 a 1	(1) $x,y,z [u,v,w]$	(2) $\bar{y},x-y,z+1/3 [v,\bar{u}+v,\bar{w}]$	(3) $\bar{x}+y,\bar{x},z+2/3 [\bar{u}+v,\bar{u},w]$

Symmetry of special projections

Along [001] $31'$	Along [100] $P_{2a^*}1$ $a^* = c$	Along [210] $P_{2a^*}1$ $a^* = c$
Origin at 0,0,z	Origin at x,0,0	Origin at x,x/2,0

$p3_2$

3

Trigonal

No. 44.1.232

$p3_2$

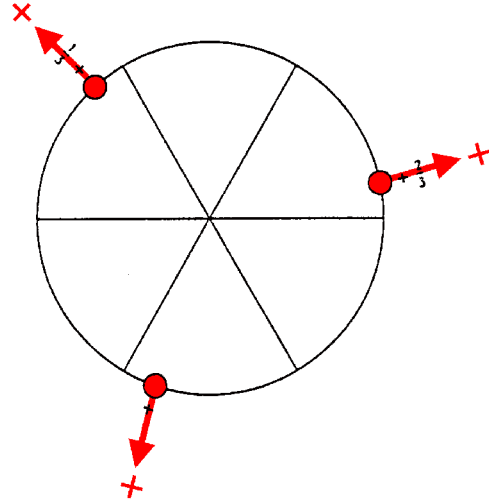
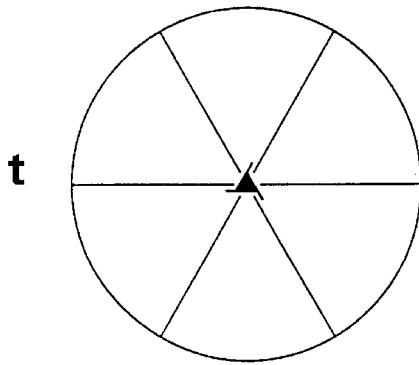

Origin on 3_2

Asymmetric unit $0 \leq x; 0 \leq y; 0 \leq z \leq 1$

Symmetry operations

(1) 1
(1|0,0,0)

(2) 3^+ (0,0,2/3) 0,0,z
 $(3_2|0,0,2/3)$

(3) 3^- (0,0,1/3) 0,0,z
 $(3_2^{-1}|0,0,1/3)$

Continued

No. 44.1.232

$\rho 3_2$

Generators selected (1); $t(0,0,1)$; (2)

Positions

	Coordinates		
Multiplicity, Wyckoff letter, Site symmetry			
3 a 1	(1) x,y,z [u,v,w]	(2) $\bar{y},x-y,z+2/3$ [$\bar{v},u-v,w$]	(3) $\bar{x}+y,\bar{x},z+1/3$ [$\bar{u}+v,\bar{u},w$]

Symmetry of special projections

Along [001] 3	Along [100] $\rho 1$ $a^* = c$	Along [210] $\rho 1$ $a^* = c$
Origin at 0,0,z	Origin at x,0,0	Origin at x,x/2,0

$p3_21'$

No. 44.2.233

$31'$

$p3_21'$

Trigonal

1'

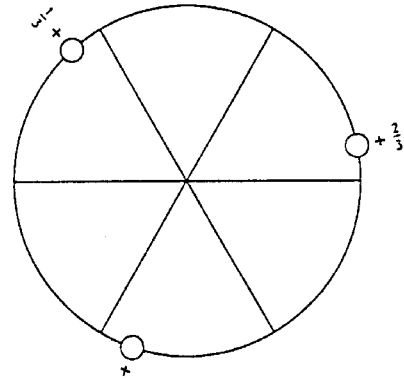
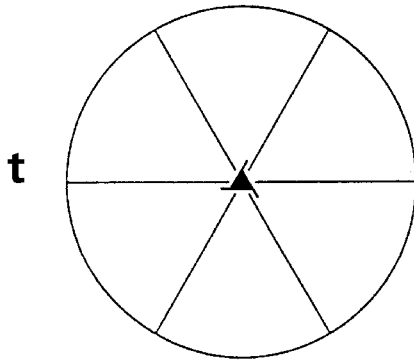

Origin on $3_21'$

Asymmetric unit $0 \leq x; 0 \leq y; 0 \leq z \leq 1$

Symmetry operations

For $1 +$ set

(1) 1
($1|0,0,0$)

(2) 3^+ ($0,0,2/3$) $0,0,z$
($3_z|0,0,2/3$)

(3) 3^- ($0,0,1/3$) $0,0,z$
($3_z^{-1}|0,0,1/3$)

For $1' +$ set

(1) $1'$
($1|0,0,0$)'

(2) $3^{+'}$ ($0,0,2/3$) $0,0,z$
($3_z|0,0,2/3$)'

(3) $3^{-'}$ ($0,0,1/3$) $0,0,z$
($3_z^{-1}|0,0,1/3$)'

Continued

No. 44.2.233

$p3_21'$

Generators selected (1); $t(0,0,1)$; (2); $1'$

Positions

Multiplicity, Wyckoff letter, Site symmetry	Coordinates		
		1+	1' +
3 a 11'	(1) x,y,z [0,0,0]	(2) $\bar{y},x-y,z+2/3$ [0,0,0]	(3) $\bar{x}+y,\bar{x},z+1/3$ [0,0,0]

Symmetry of special projections

Along [001] $31'$	Along [100] $p11'$	Along [210] $p11'$
Origin at 0,0,z	$a^* = c$ Origin at x,0,0	$a^* = c$ Origin at x,x/2,0

$\rho_{2c}3_1$

$31'$

Trigonal

No. 44.3.234

$\rho_{2c}3_1$

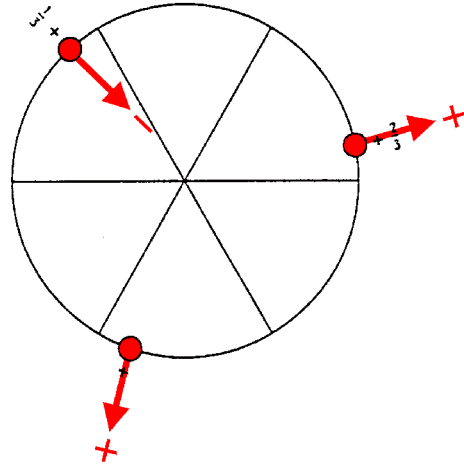
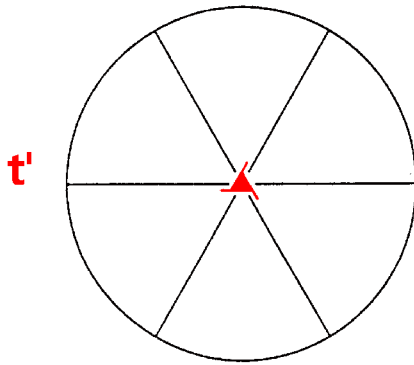

Origin on $3_2'$

Asymmetric unit $0 \leq x; 0 \leq y; 0 \leq z \leq 1$

Symmetry operations

For $(0,0,0)$ + set

(1) 1

$(1|0,0,0)$

(2) $3^+ (0,0,2/3) \ 0,0,z$

$(3_2|0,0,2/3)$

(3) $3^- (0,0,1/3) \ 0,0,z$

$(3_2^{-1}|0,0,1/3)'$

For $(0,0,1)$ + set

(1) $t' (0,0,1)$

$(1|0,0,1)'$

(2) $3^{+'} (0,0,5/3) \ 0,0,z$

$(3_2|0,0,5/3)'$

(3) $3^- (0,0,4/3) \ 0,0,z$

$(3_2^{-1}|0,0,4/3)$

Continued

No. 44.3.234

$\rho_{2c} 3_1$

Generators selected (1); $t(0,0,1)'$; (2)

Positions

Multiplicity, Wyckoff letter, Site symmetry	Coordinates		
		(0,0,0)+	(0,0,1)' +
3 a 1	(1) $x,y,z [u,v,w]$	(2) $\bar{y},x-y,z+2/3 [\bar{v},u-v,w]$	(3) $\bar{x}+y,\bar{x},z+1/3 [u-v,u,\bar{w}]$

Symmetry of special projections

Along [001] $31'$	Along [100] $\rho_{2a^*} 1$ $a^* = c$	Along [210] $\rho_{2a^*} 1$ $a^* = c$
Origin at 0,0,z	Origin at x,0,0	Origin at x,x/2,0

$p\bar{3}$

No. 45.1.235

$\bar{3}$

$p\bar{3}$

Trigonal

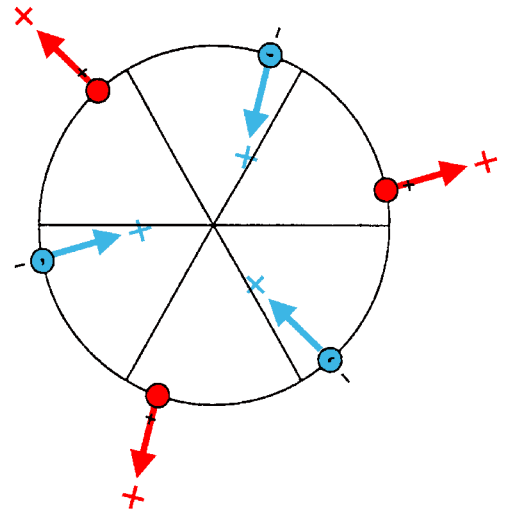
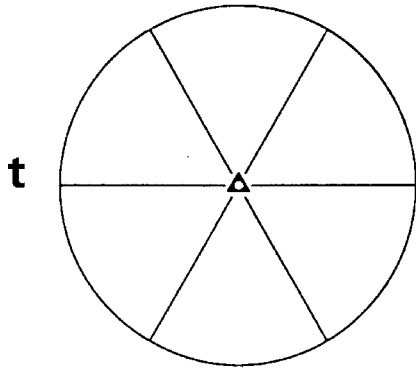

Origin at center ($\bar{3}$)

Asymmetric unit $0 \leq x; 0 \leq y; 0 \leq z \leq 1/2$

Symmetry operations

(1) 1
(1|0,0,0)

(2) 3^+ 0,0,z
(3_z |0,0,0)

(3) 3^- 0,0,z
(3_z^{-1} |0,0,0)

(4) $\bar{1}$ 0,0,0
($\bar{1}$ |0,0,0)

(5) $\bar{3}^+$ 0,0,z; 0,0,0
($\bar{3}_z$ |0,0,0)

(6) $\bar{3}^-$ 0,0,z; 0,0,0
($\bar{3}_z^{-1}$ |0,0,0)

Continued

No. 45.1.235

 $p\bar{3}$ Generators selected (1); $t(0,0,1)$; (2); (4)

Positions

		Coordinates		
Multiplicity, Wyckoff letter, Site symmetry				
6	d 1	(1) x,y,z [u,v,w]	(2) $\bar{y},x-y,z$ [$\bar{v},u-v,w$]	(3) $\bar{x}+y,\bar{x},z$ [$\bar{u}+v,\bar{u},w$]
		(4) \bar{x},\bar{y},\bar{z} [u,v,w]	(5) $y,\bar{x}+y,\bar{z}$ [$\bar{v},u-v,w$]	(6) $x-y,x,\bar{z}$ [$\bar{u}+v,\bar{u},w$]
2	c 3..	$0,0,z$ [$0,0,w$]	$0,0,\bar{z}$ [$0,0,w$]	
1	b $\bar{3}$..	$0,0,1/2$ [$0,0,w$]		
1	a $\bar{3}$..	$0,0,0$ [$0,0,w$]		

Symmetry of special projections

Along [001] $6'$	Along [100] $p2'11$	Along [210] $p2'11$
	$a^* = c$	$a^* = c$
Origin at $0,0,z$	Origin at $x,0,0$	Origin at $x,x/2,0$

$p\bar{3}1'$

No. 45.2.236

$\bar{3}1'$

$p\bar{3}1'$

Trigonal

t

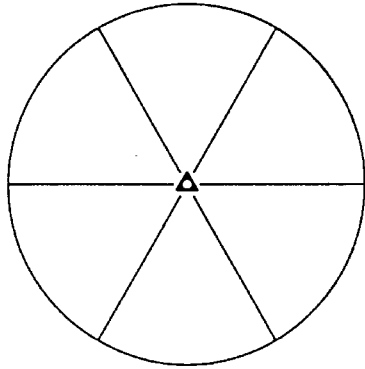

1'

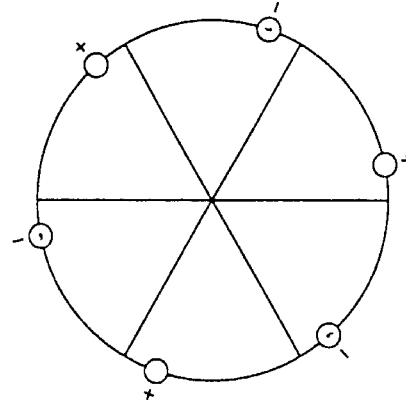

Origin at center ($\bar{3}1'$)

Asymmetric unit $0 \leq x; 0 \leq y; 0 \leq z \leq 1/2$

Symmetry operations

For $1 +$ set

(1) 1
($1|0,0,0$)

(2) 3^+ $0,0,z$
($3_z|0,0,0$)

(3) 3^- $0,0,z$
($3_z^{-1}|0,0,0$)

(4) $\bar{1}$ $0,0,0$
($\bar{1}|0,0,0$)

(5) $\bar{3}^+$ $0,0,z; 0,0,0$
($\bar{3}_z|0,0,0$)

(6) $\bar{3}^-$ $0,0,z; 0,0,0$
($\bar{3}_z^{-1}|0,0,0$)

For $1' +$ set

(1) $1'$
($1|0,0,0$)'

(2) $3^{+'}$ $0,0,z$
($3_z|0,0,0$)'

(3) $3^{-'}$ $0,0,z$
($3_z^{-1}|0,0,0$)'

(4) $\bar{1}'$ $0,0,0$
($\bar{1}|0,0,0$)'

(5) $\bar{3}^{+'}$ $0,0,z; 0,0,0$
($\bar{3}_z|0,0,0$)'

(6) $\bar{3}^{-'}$ $0,0,z; 0,0,0$
($\bar{3}_z^{-1}|0,0,0$)'

Continued

No. 45.2.236

 $p\bar{3}1'$ Generators selected (1); $t(0,0,1)$; (2); (4); $1'$

Positions

Multiplicity, Wyckoff letter, Site symmetry	Coordinates		
		1+	1'+
6 d $11'$	(1) x,y,z [0,0,0]	(2) $\bar{y},x-y,z$ [0,0,0]	(3) $\bar{x}+y,\bar{x},z$ [0,0,0]
	(4) \bar{x},\bar{y},\bar{z} [0,0,0]	(5) $y,\bar{x}+y,\bar{z}$ [0,0,0]	(6) $x-y,x,\bar{z}$ [0,0,0]
2 c $3..1'$	$0,0,z$ [0,0,0]	$0,0,\bar{z}$ [0,0,0]	
1 b $\bar{3}..1'$	$0,0,1/2$ [0,0,0]		
1 a $\bar{3}..1'$	$0,0,0$ [0,0,0]		

Symmetry of special projections

Along [001] $61'$	Along [100] $p2111'$	Along [210] $p2111'$
Origin at 0,0,z	$a^* = c$ Origin at $x,0,0$	$a^* = c$ Origin at $x,x/2,0$

$p\bar{3}'$

No. 45.3.237

t

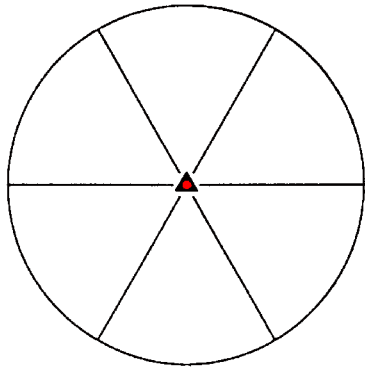

$\bar{3}'$

$p\bar{3}'$

Trigonal

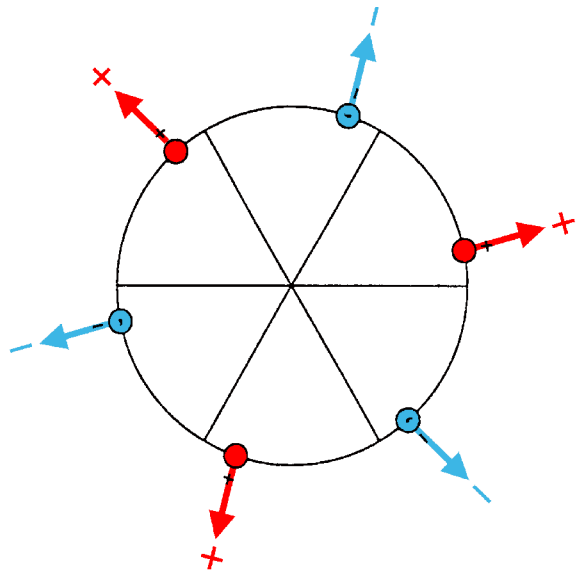

Origin at center ($\bar{3}'$)

Asymmetric unit $0 \leq x; 0 \leq y; 0 \leq z \leq 1/2$

Symmetry operations

(1) 1
(1|0,0,0)

(2) 3^+ 0,0,z
(3_z |0,0,0)

(3) 3^- 0,0,z
(3_z^{-1} |0,0,0)

(4) $\bar{1}'$ 0,0,0
($\bar{1}$ |0,0,0)

(5) $\bar{3}^{+ '}$ 0,0,z; 0,0,0
($\bar{3}_z$ |0,0,0)

(6) $\bar{3}^{- '}$ 0,0,z; 0,0,0
($\bar{3}_z^{-1}$ |0,0,0)

Continued

No. 45.3.237

 $p\bar{3}'$ Generators selected (1); $t(0,0,1)$; (2); (4)

Positions

Multiplicity, Wyckoff letter, Site symmetry	Coordinates		
	(1) x,y,z [u,v,w]	(2) $\bar{y},x-y,z$ [$\bar{v},u-v,w$]	(3) $\bar{x}+y,\bar{x},z$ [$\bar{u}+v,\bar{u},w$]
6 d 1	(4) \bar{x},\bar{y},\bar{z} [\bar{u},\bar{v},\bar{w}]	(5) $y,\bar{x}+y,\bar{z}$ [$v,\bar{u}+v,\bar{w}$]	(6) $x-y,x,\bar{z}$ [$u-v,u,\bar{w}$]
2 c 3..	$0,0,z$ [$0,0,w$]	$0,0,\bar{z}$ [$0,0,\bar{w}$]	
1 b $\bar{3}'..$	$0,0,1/2$ [$0,0,0$]		
1 a $\bar{3}'..$	$0,0,0$ [$0,0,0$]		

Symmetry of special projections

Along [001] 6	Along [100] $p211$ $a^* = c$	Along [210] $p211$ $a^* = c$
Origin at $0,0,z$	Origin at $x,0,0$	Origin at $x,x/2,0$

$\rho_{2c}\bar{3}$

No. 45.4.238

 $\bar{3}1'$ $\rho_{2c}\bar{3}$

Trigonal

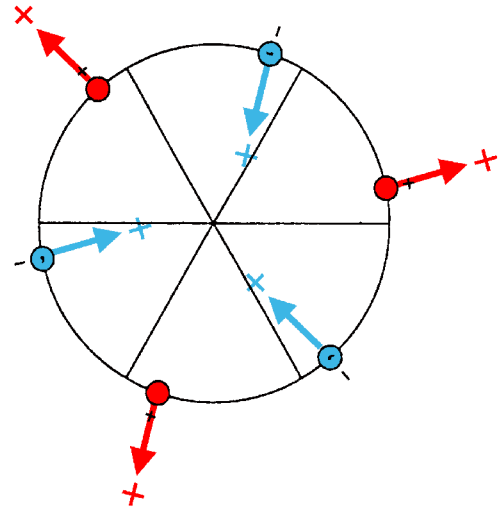
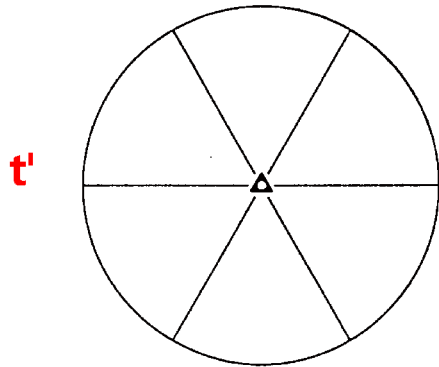
Origin at center ($\bar{3}$)Asymmetric unit $0 \leq x$; $0 \leq y$; $0 \leq z \leq 1/2$

Symmetry operations

For (0,0,0) + set

- | | | |
|---|---|--|
| (1) 1
(1 0,0,0) | (2) 3^+ 0,0,z
(3_z 0,0,0) | (3) 3^- 0,0,z
(3_z^{-1} 0,0,0) |
| (4) $\bar{1}$ 0,0,0
($\bar{1}$ 0,0,0) | (5) $\bar{3}^+$ 0,0,z; 0,0,0
($\bar{3}_z$ 0,0,0) | (6) $\bar{3}^-$ 0,0,z; 0,0,0
($\bar{3}_z^{-1}$ 0,0,0) |
| For (0,0,1)' + set | | |
| (1) t' (0,0,1)
(1 0,0,1)' | (2) $3^{+'}$ (0,0,1) 0,0,z
(3_z 0,0,1)' | (3) $3^{-'}$ (0,0,1) 0,0,z
(3_z^{-1} 0,0,1)' |
| (4) $\bar{1}$ ' 0,0,1/2
($\bar{1}$ 0,0,1)' | (5) $\bar{3}^{+'}$ 0,0,z; 0,0,1/2
($\bar{3}_z$ 0,0,1)' | (6) $\bar{3}^{-'}$ 0,0,z; 0,0,1/2
($\bar{3}_z^{-1}$ 0,0,1)' |

Continued

No. 45.4.238

 $p_{2c} \bar{3}$ Generators selected (1); $t(0,0,1)'$; (2); (4)

Positions

Multiplicity, Wyckoff letter, Site symmetry	Coordinates		
		(0,0,0)+	(0,0,1)' +
6 d 1	(1) x,y,z [u,v,w]	(2) $\bar{y},x-y,z$ [$\bar{v},u-v,w$]	(3) $\bar{x}+y,\bar{x},z$ [$\bar{u}+v,\bar{u},w$]
	(4) \bar{x},\bar{y},\bar{z} [u,v,w]	(5) $y,\bar{x}+y,\bar{z}$ [$\bar{v},u-v,w$]	(6) $x-y,x,\bar{z}$ [$\bar{u}+v,\bar{u},w$]
2 c 3..	0,0,z [0,0,w]	0,0, \bar{z} [0,0,w]	
1 b $\bar{3}'..$	0,0,1/2 [0,0,0]		
1 a $\bar{3}..$	0,0,0 [0,0,w]		

Symmetry of special projections

Along [001] $61'$	Along [100] $p_{2a^*} 2'11$ $a^* = c$	Along [210] $p_{2a^*} 2'11$ $a^* = c$
Origin at 0,0,z	Origin at x,0,0	Origin at x,x/2,0

p312

312

Trigonal

No. 46.1.239

p312

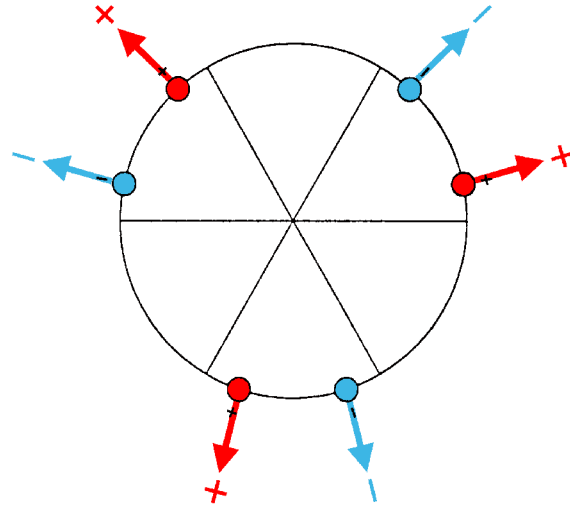
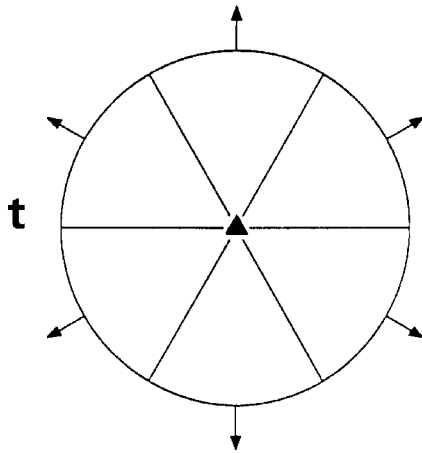

Origin at 312

Asymmetric unit $0 \leq x$; $0 \leq y$; $0 \leq z \leq 1/2$

Symmetry operations

(1) 1
(1|0,0,0)

(2) 3^+ 0,0,z
(3_z |0,0,0)

(3) 3^- 0,0,z
(3_z^{-1} |0,0,0)

(4) 2 $x, \bar{x}, 0$
(2_3 |0,0,0)

(5) 2 $x, 2x, 0$
(2_2 |0,0,0)

(6) 2 $2x, x, 0$
(2_1 |0,0,0)

Generators selected (1); $t(0,0,1)$; (2); (4)

Positions

Multiplicity, Wyckoff letter, Site symmetry	Coordinates		
	(1) x,y,z [u,v,w]	(2) $\bar{y},x-y,z$ [$\bar{v},u-v,w$]	(3) $\bar{x}+y,\bar{x},z$ [$\bar{u}+v,\bar{u},w$]
6 f 1	(4) \bar{y},\bar{x},\bar{z} [\bar{v},\bar{u},\bar{w}]	(5) $\bar{x}+y,y,\bar{z}$ [$\bar{u}+v,v,\bar{w}$]	(6) $x,x-y,\bar{z}$ [$u,u-v,\bar{w}$]
3 e ..2	$x,\bar{x},1/2$ [$u,\bar{u},0$]	$x,2x,1/2$ [$u,2u,0$]	$2\bar{x},\bar{x},1/2$ [$2\bar{u},\bar{u},0$]
3 d ..2	$x,\bar{x},0$ [$u,\bar{u},0$]	$x,2x,0$ [$u,2u,0$]	$2\bar{x},\bar{x},0$ [$2\bar{u},\bar{u},0$]
2 c 3..	$0,0,z$ [$0,0,w$]	$0,0,\bar{z}$ [$0,0,\bar{w}$]	
1 b 3.2	$0,0,1/2$ [$0,0,0$]		
1 a 3.2	$0,0,0$ [$0,0,0$]		

Symmetry of special projections

Along [001] $3m'$	Along [100] $p1m'1$	Along [210] $p211$
Origin at $0,0,z$	$a^* = c$ Origin at $x,0,0$	$a^* = c$ Origin at $x,x/2,0$

$p3121'$

$3121'$

Trigonal

No. 46.2.240

$p3121'$

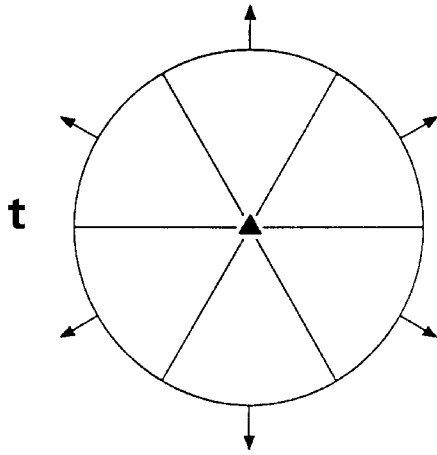

1'

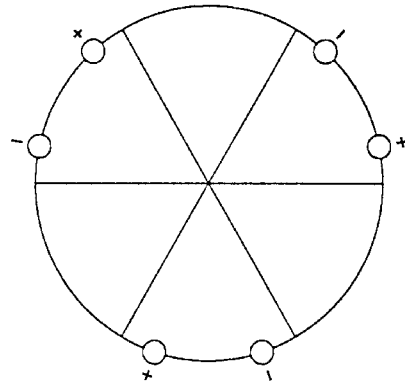

Origin at $3121'$

Asymmetric unit $0 \leq x; 0 \leq y; 0 \leq z \leq 1/2$

Symmetry operations

For $1 +$ set

- | | | |
|--|--------------------------------------|---|
| (1) 1
($1 0,0,0$) | (2) 3^+ $0,0,z$
($3_z 0,0,0$) | (3) 3^- $0,0,z$
($3_z^{-1} 0,0,0$) |
| (4) 2 $x,\bar{x},0$
($2_3 0,0,0$) | (5) 2 $x,2x,0$
($2_2 0,0,0$) | (6) 2 $2x,x,0$
($2_1 0,0,0$) |

For $1' +$ set

- | | | |
|--|---|--|
| (1) $1'$
($1 0,0,0$)' | (2) $3^{+ '}$ $0,0,z$
($3_z 0,0,0$)' | (3) $3^{- '}$ $0,0,z$
($3_z^{-1} 0,0,0$)' |
| (4) $2'$ $x,\bar{x},0$
($2_3 0,0,0$)' | (5) $2'$ $x,2x,0$
($2_2 0,0,0$)' | (6) $2'$ $2x,x,0$
($2_1 0,0,0$)' |

Generators selected (1); $t(0,0,1)$; (2); (4); $1'$

Positions

Multiplicity, Wyckoff letter, Site symmetry	Coordinates		
		$1+$	$1' +$
6 f $11'$	(1) $x,y,z [0,0,0]$	(2) $\bar{y},x-y,z [0,0,0]$	(3) $\bar{x}+y,\bar{x},z [0,0,0]$
	(4) $\bar{y},\bar{x},\bar{z} [0,0,0]$	(5) $\bar{x}+y,y,\bar{z} [0,0,0]$	(6) $x,x-y,\bar{z} [0,0,0]$
3 e $..21'$	$x,\bar{x},1/2 [0,0,0]$	$x,2x,1/2 [0,0,0]$	$2\bar{x},\bar{x},1/2 [0,0,0]$
3 d $..21'$	$x,\bar{x},0 [0,0,0]$	$x,2x,0 [0,0,0]$	$2\bar{x},\bar{x},0 [0,0,0]$
2 c $3..1'$	$0,0,z [0,0,0]$	$0,0,\bar{z} [0,0,0]$	
1 b $3.21'$	$0,0,1/2 [0,0,0]$		
1 a $3.21'$	$0,0,0 [0,0,0]$		

Symmetry of special projections

Along [001] $3m1'$	Along [100] $p1m11'$	Along [210] $p2111'$
Origin at $0,0,z$	$a^* = c$ Origin at $x,0,0$	$a^* = c$ Origin at $x,x/2,0$

$p312'$

No. 46.3.241

$312'$

$p312'$

Trigonal

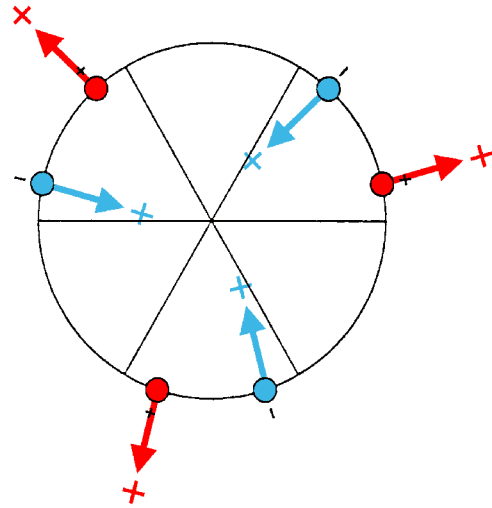
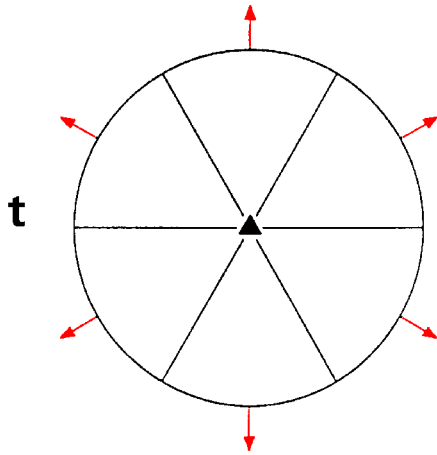

Origin at $312'$

Asymmetric unit $0 \leq x; 0 \leq y; 0 \leq z \leq 1/2$

Symmetry operations

(1) 1
(1|0,0,0)

(2) 3^+ 0,0,z
(3_z |0,0,0)

(3) 3^- 0,0,z
(3_z^{-1} |0,0,0)

(4) $2'$ x, \bar{x} ,0
(2_3 |0,0,0)'

(5) $2'$ x,2x,0
(2_2 |0,0,0)'

(6) $2'$ 2x,x,0
(2_1 |0,0,0)'

Generators selected (1); $t(0,0,1)$; (2); (4)

Positions

Multiplicity, Wyckoff letter, Site symmetry	Coordinates		
	(1) x,y,z [u,v,w]	(2) $\bar{y},x-y,z$ [$\bar{v},u-v,w$]	(3) $\bar{x}+y,\bar{x},z$ [$\bar{u}+v,\bar{u},w$]
6 f 1	(4) \bar{y},\bar{x},\bar{z} [v,u,w]	(5) $\bar{x}+y,y,\bar{z}$ [u-v, \bar{v},w]	(6) $x,x-y,\bar{z}$ [$\bar{u},\bar{u}+v,w$]
3 e ..2'	$x,\bar{x},1/2$ [u,u,w]	$x,2x,1/2$ [$\bar{u},0,w$]	$2\bar{x},\bar{x},1/2$ [0, \bar{u},w]
3 d ..2'	$x,\bar{x},0$ [u,u,w]	$x,2x,0$ [$\bar{u},0,w$]	$2\bar{x},\bar{x},0$ [0, \bar{u},w]
2 c 3..	$0,0,z$ [0,0,w]	$0,0,\bar{z}$ [0,0,w]	
1 b 3.2'	$0,0,1/2$ [0,0,w]		
1 a 3.2'	$0,0,0$ [0,0,w]		

Symmetry of special projections

Along [001] 3m	Along [100] $p1m1$ $a^* = c$	Along [210] $p2'11$ $a^* = c$
Origin at 0,0,z	Origin at x,0,0	Origin at x,x/2,0

$p_{2c}312$

3121'

Trigonal

No. 46.4.242

$p_{2c}312$

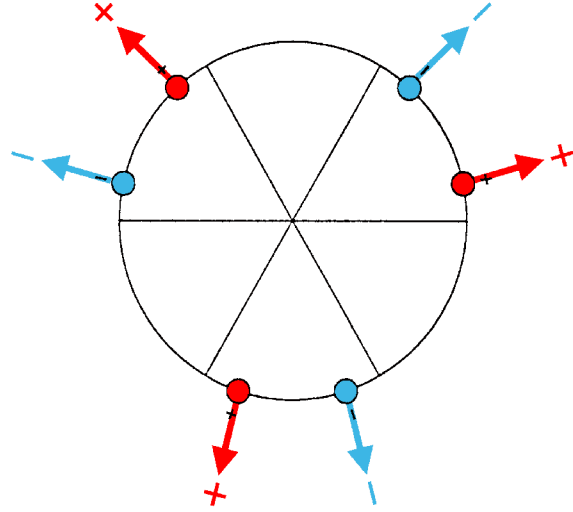
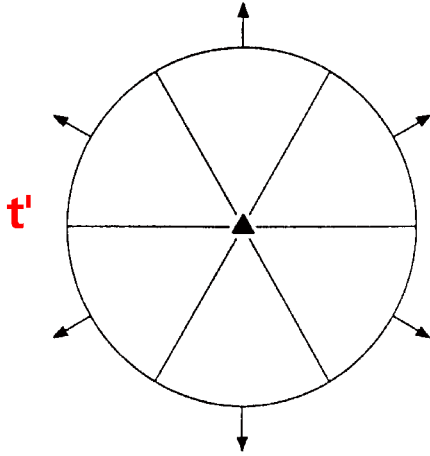

Origin at 312

Asymmetric unit $0 \leq x; 0 \leq y; 0 \leq z \leq 1/2$

Symmetry operations

For (0,0,0) + set

- | | | |
|--|-------------------------------------|---|
| (1) 1
(1 0,0,0) | (2) 3^+ 0,0,z
(3_z 0,0,0) | (3) 3^- 0,0,z
(3_z^{-1} 0,0,0) |
| (4) 2 $x, \bar{x}, 0$
(2_3 0,0,0) | (5) 2 $x, 2x, 0$
(2_2 0,0,0) | (6) 2 $2x, x, 0$
(2_1 0,0,0) |

For (0,0,1)' + set

- | | | |
|--|---|--|
| (1) t' (0,0,1)
(1 0,0,1)' | (2) $3^{+ '}$ (0,0,1) 0,0,z
(3_z 0,0,1)' | (3) $3^{- '}$ (0,0,1) 0,0,z
(3_z^{-1} 0,0,1)' |
| (4) $2'$ $x, \bar{x}, 1/2$
(2_3 0,0,1)' | (5) $2'$ $x, 2x, 1/2$
(2_2 0,0,1)' | (6) $2'$ $2x, x, 1/2$
(2_1 0,0,1)' |

Generators selected (1); $t(0,0,1)'$; (2); (4)

Positions

Multiplicity, Wyckoff letter, Site symmetry	Coordinates		
		(0,0,0)+	(0,0,1)' +
6 f 1	(1) x,y,z [u,v,w]	(2) $\bar{y},x-y,z$ [$\bar{v},u-v,w$]	(3) $\bar{x}+y,\bar{x},z$ [$\bar{u}+v,\bar{u},w$]
	(4) \bar{y},\bar{x},\bar{z} [\bar{v},\bar{u},\bar{w}]	(5) $\bar{x}+y,y,\bar{z}$ [$\bar{u}+v,v,\bar{w}$]	(6) $x,x-y,\bar{z}$ [u,u-v, \bar{w}]
3 e ..2'	$x,\bar{x},1/2$ [u,u,w]	$x,2x,1/2$ [$\bar{u},0,w$]	$2\bar{x},\bar{x},1/2$ [0, \bar{u},w]
3 d ..2	$x,\bar{x},0$ [u, $\bar{u},0$]	$x,2x,0$ [u,2u,0]	$2\bar{x},\bar{x},0$ [2 $\bar{u},\bar{u},0$]
2 c 3..	$0,0,z$ [0,0,w]	$0,0,\bar{z}$ [0,0,w]	
1 b 3.2'	$0,0,1/2$ [0,0,w]		
1 a 3.2	$0,0,0$ [0,0,0]		

Symmetry of special projections

Along [001] $3m'$	Along [100] $p_{2a^*} 1m'1$	Along [210] $p_{2a^*} 211$
Origin at 0,0,z	$a^* = c$ Origin at x,0,0	$a^* = c$ Origin at x,x/2,0

$p3_112$

312

Trigonal

No. 47.1.243

$p3_112$

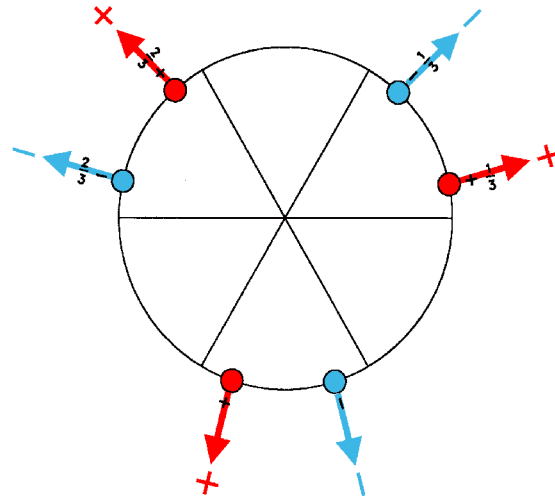
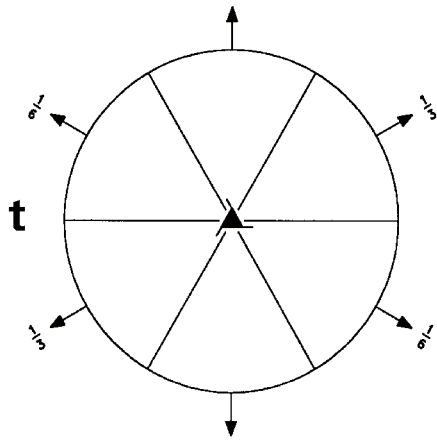

Origin on $2[210]$ at $3_1(1,1,2)$

Asymmetric unit $0 \leq x; 0 \leq y; 0 \leq z \leq 1/2$

Symmetry operations

(1) 1
(1|0,0,0)

(2) 3^+ (0,0,1/3) 0,0,z
(3_2 |0,0,1/3)

(3) 3^- (0,0,2/3) 0,0,z
(3_2^{-1} |0,0,2/3)

(4) 2 x, \bar{x} ,1/3
(2_3 |0,0,2/3)

(5) 2 x,2x,1/6
(2_2 |0,0,1/3)

(6) 2 2x,x,0
(2_1 |0,0,0)

Generators selected (1); t(0,0,1); (2); (4)

Positions

Multiplicity, Wyckoff letter, Site symmetry	Coordinates		
	(1) x, y, z [u, v, w]	(2) $\bar{y}, x-y, z+1/3$ [$\bar{v}, u-v, w$]	(3) $\bar{x}+y, \bar{x}, z+2/3$ [$\bar{u}+v, \bar{u}, w$]
6 c 1	(4) $\bar{y}, \bar{x}, \bar{z}+2/3$ [$\bar{v}, \bar{u}, \bar{w}$]	(5) $\bar{x}+y, y, \bar{z}+1/3$ [$\bar{u}+v, v, \bar{w}$]	(6) $x, x-y, \bar{z}$ [u, u-v, \bar{w}]
3 b ..2	$x, \bar{x}, 5/6$ [u, $\bar{u}, 0$]	$x, 2x, 1/6$ [u, 2u, 0]	$2\bar{x}, \bar{x}, 1/2$ [2 $\bar{u}, \bar{u}, 0$]
3 a ..2	$x, \bar{x}, 1/3$ [u, $\bar{u}, 0$]	$x, 2x, 2/3$ [u, 2u, 0]	$2\bar{x}, \bar{x}, 0$ [2 $\bar{u}, \bar{u}, 0$]

Symmetry of special projections

Along [001] 3m'	Along [100] $p1m'1$ $a^* = c$	Along [210] $p211$ $a^* = c$
Origin at 0,0,z	Origin at x,0,1/6	Origin at x,x/2,0

$p3_1121'$

$3121'$

Trigonal

No. 47.2.244

$p3_1121'$

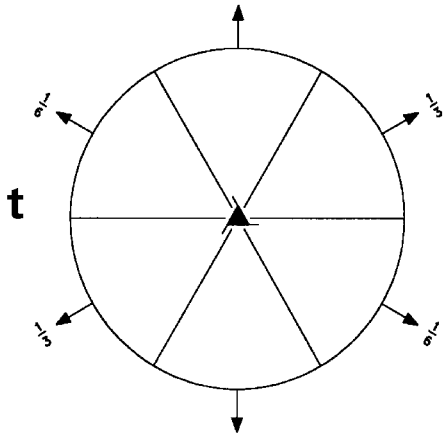

1'

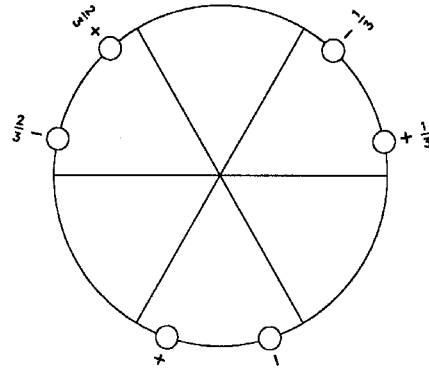

Origin on $21'[210]$ at $3_11(1,1,2)1'$

Asymmetric unit $0 \leq x; 0 \leq y; 0 \leq z \leq 1/2$

Symmetry operations

For $1 +$ set

(1) 1
($1|0,0,0$)

(2) $3^+ (0,0,1/3) \ 0,0,z$
($3_z|0,0,1/3$)

(3) $3^- (0,0,2/3) \ 0,0,z$
($3_z^{-1}|0,0,2/3$)

(4) $2 \ x,\bar{x},1/3$
($2_3|0,0,2/3$)

(5) $2 \ x,2x,1/6$
($2_2|0,0,1/3$)

(6) $2 \ 2x,x,0$
($2_1|0,0,0$)

For $1' +$ set

(1) $1'$
($1|0,0,0$)'

(2) $3^{+'} (0,0,1/3) \ 0,0,z$
($3_z|0,0,1/3$)'

(3) $3^{-'} (0,0,2/3) \ 0,0,z$
($3_z^{-1}|0,0,2/3$)'

(4) $2'$ $x,\bar{x},1/3$
($2_3|0,0,2/3$)'

(5) $2'$ $x,2x,1/6$
($2_2|0,0,1/3$)'

(6) $2'$ $2x,x,0$
($2_1|0,0,0$)'

Generators selected (1); $t(0,0,1)$; (2); (4); $1'$

Positions

Multiplicity, Wyckoff letter, Site symmetry	Coordinates		
		$1+$	$1'+$
6 c $11'$	(1) x,y,z [0,0,0]	(2) $\bar{y},x-y,z+1/3$ [0,0,0]	(3) $\bar{x}+y,\bar{x},z+2/3$ [0,0,0]
	(4) $\bar{y},\bar{x},\bar{z}+2/3$ [0,0,0]	(5) $\bar{x}+y,y,\bar{z}+1/3$ [0,0,0]	(6) $x,x-y,\bar{z}$ [0,0,0]
3 b $..21'$	$x,\bar{x},5/6$ [0,0,0]	$x,2x,1/6$ [0,0,0]	$2\bar{x},\bar{x},1/2$ [0,0,0]
3 a $..21'$	$x,\bar{x},1/3$ [0,0,0]	$x,2x,2/3$ [0,0,0]	$2\bar{x},\bar{x},0$ [0,0,0]

Symmetry of special projections

Along [001] $3m1'$	Along [100] $p1m11'$	Along [210] $p2111'$
Origin at 0,0,z	$a^* = c$ Origin at $x,0,1/6$	$a^* = c$ Origin at $x,x/2,0$

$p3_112'$

$312'$

Trigonal

No. 47.3.245

$p3_112'$

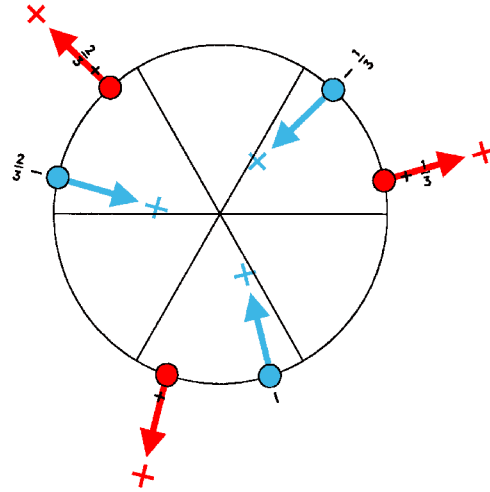
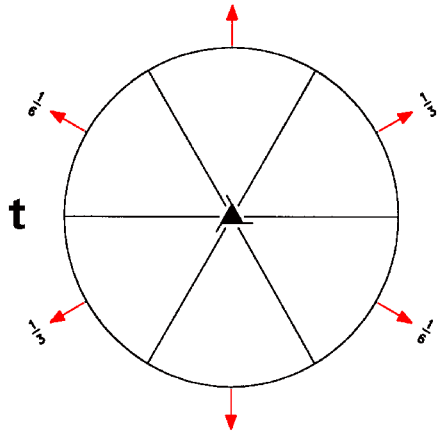

Origin on $2'[210]$ at $3_11(1,1,2')$

Asymmetric unit $0 \leq x; 0 \leq y; 0 \leq z \leq 1/2$

Symmetry operations

(1) 1
(1|0,0,0)

(2) $3^+ (0,0,1/3) 0,0,z$
(3_2 |0,0,1/3)

(3) $3^- (0,0,2/3) 0,0,z$
(3_2^{-1} |0,0,2/3)

(4) $2' x, \bar{x}, 1/3$
(2_3 |0,0,2/3)'

(5) $2' x, 2x, 1/6$
(2_2 |0,0,1/3)'

(6) $2' 2x, x, 0$
(2_1 |0,0,0)'

Generators selected (1); $t(0,0,1)$; (2); (4)

Positions

Multiplicity, Wyckoff letter, Site symmetry	Coordinates		
	(1) x,y,z [u,v,w]	(2) $\bar{y},x-y,z+1/3$ [$\bar{v},u-v,w$]	(3) $\bar{x}+y,\bar{x},z+2/3$ [$\bar{u}+v,\bar{u},w$]
6 c 1	(4) $\bar{y},\bar{x},\bar{z}+2/3$ [v,u,w]	(5) $\bar{x}+y,y,\bar{z}+1/3$ [u-v, \bar{v},w]	(6) $x,x-y,\bar{z}$ [$\bar{u},\bar{u}+v,w$]
3 b ..2	$x,\bar{x},5/6$ [u,u,w]	$x,2x,1/6$ [$\bar{u},0,w$]	$2\bar{x},\bar{x},1/2$ [0, \bar{u},w]
3 a ..2	$x,\bar{x},1/3$ [u,u,w]	$x,2x,2/3$ [$\bar{u},0,w$]	$2\bar{x},\bar{x},0$ [0, \bar{u},w]

Symmetry of special projections

Along [001] $3m$ Origin at 0,0,z	Along [100] $\rho 1m1$ $a^* = c$ Origin at $x,0,1/6$	Along [210] $\rho 2'11$ $a^* = c$ Origin at $x,x/2,0$
-------------------------------------	--	---

$p_{2c}3_212$

3121'

Trigonal

No. 47.4.246

$p_{2c}3_212$

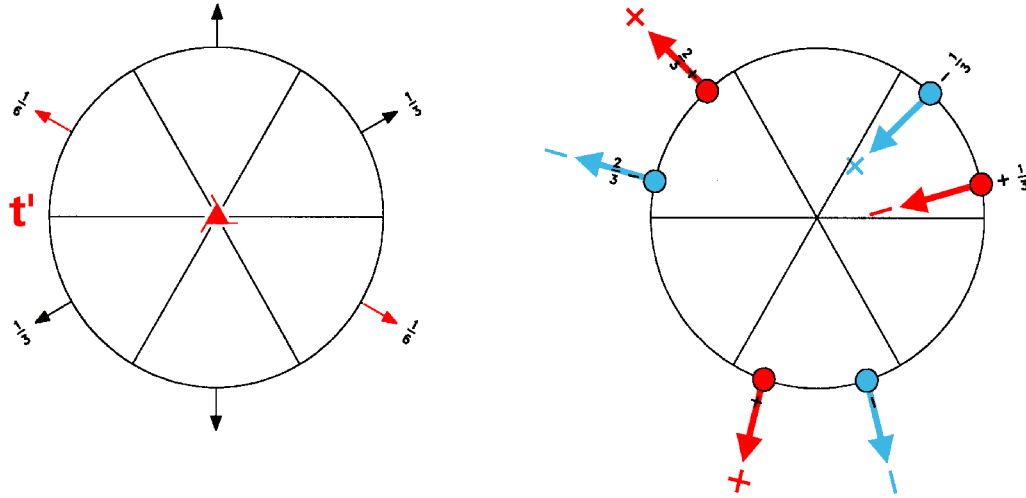

Origin on $2[210]$ at $3_1'1(1,1,2)$

Asymmetric unit $0 \leq x$; $0 \leq y$; $0 \leq z \leq 1/2$

Symmetry operations

For $(0,0,0)$ + set

- | | | |
|--|---|---|
| (1) 1
(1 0,0,0) | (2) 3^{+} $(0,0,1/3)$ $0,0,z$
(3_z 0,0,1/3)' | (3) 3^{-} $(0,0,2/3)$ $0,0,z$
(3_z^{-1} 0,0,2/3) |
| (4) 2 $x, \bar{x}, 1/3$
(2_3 0,0,2/3) | (5) $2'$ $x, 2x, 1/6$
(2_2 0,0,1/3)' | (6) 2 $2x, x, 0$
(2_1 0,0,0) |

For $(0,0,1)'$ + set

- | | | |
|--|--|--|
| (1) t' $(0,0,1)$
(1 0,0,0)' | (2) 3^{+} $(0,0,4/3)$ $0,0,z$
(3_z 0,0,4/3) | (3) 3^{-} $(0,0,5/3)$ $0,0,z$
(3_z^{-1} 0,0,5/3)' |
| (4) $2'$ $x, \bar{x}, 5/6$
(2_3 0,0,5/3)' | (5) 2 $x, 2x, 2/3$
(2_2 0,0,4/3) | (6) $2'$ $2x, x, 1/2$
(2_1 0,0,1)' |

Generators selected (1); $t(0,0,1)'$; (2); (4)

Positions

Multiplicity, Wyckoff letter, Site symmetry	Coordinates		
		$(0,0,0)_+$	$(0,0,1)'$ +
6 c 1	(1) x,y,z [u,v,w]	(2) $\bar{y},x-y,z+1/3$ [v, $\bar{u}+v,\bar{w}$]	(3) $\bar{x}+y,\bar{x},z+2/3$ [$\bar{u}+v,\bar{u},w$]
	(4) $\bar{y},\bar{x},\bar{z}+2/3$ [\bar{v},\bar{u},\bar{w}]	(5) $\bar{x}+y,y,\bar{z}+1/3$ [u-v, \bar{v},w]	(6) $x,x-y,\bar{z}$ [u,u-v, \bar{w}]
3 b ..2'	$x,\bar{x},5/6$ [u,u,w]	$x,2x,1/6$ [$\bar{u},0,w$]	$2\bar{x},\bar{x},1/2$ [0,u, \bar{w}]
3 a ..2	$x,\bar{x},1/3$ [u, $\bar{u},0$]	$x,2x,2/3$ [$\bar{u},2\bar{u},0$]	$2\bar{x},\bar{x},0$ [2u,u,0]

Symmetry of special projections

Along [001] $3m1'$	Along [100] $p_{2a^*} 1m'1$	Along [210] $p_{2a^*} 211$
Origin at 0,0,z	$a^* = c$ Origin at $x,0,1/6$	$a^* = c$ Origin at $x,x/2,0$

$p3_212$

312

Trigonal

No. 48.1.247

$p3_212$

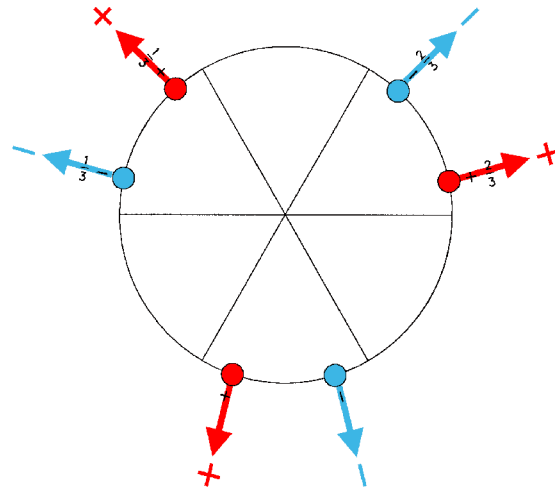
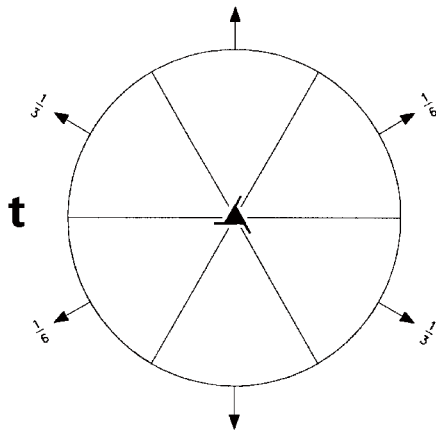

Origin on $2[210]$ at $3_21(1,1,2)$

Asymmetric unit $0 \leq x$; $0 \leq y$; $0 \leq z \leq 1/2$

Symmetry operations

(1) 1
(1|0,0,0)

(2) 3^+ (0,0,2/3) 0,0,z
(3_2 |0,0,2/3)

(3) 3^- (0,0,1/3) 0,0,z
(3_2^{-1} |0,0,1/3)

(4) 2 $x, \bar{x}, 1/6$
(2_3 |0,0,1/3)

(5) 2 $x, 2x, 1/3$
(2_2 |0,0,2/3)

(6) 2 $2x, x, 0$
(2_1 |0,0,0)

Generators selected (1); $t(0,0,1)$; (2); (4)

Positions

Multiplicity, Wyckoff letter, Site symmetry	Coordinates		
	(1) x,y,z [u,v,w]	(2) $\bar{y},x-y,z+2/3$ [$\bar{v},u-v,w$]	(3) $\bar{x}+y,\bar{x},z+1/3$ [$\bar{u}+v,\bar{u},w$]
6 c 1	(4) $\bar{y},\bar{x},\bar{z}+1/3$ [\bar{v},\bar{u},\bar{w}]	(5) $\bar{x}+y,y,\bar{z}+2/3$ [$\bar{u}+v,v,\bar{w}$]	(6) $x,x-y,\bar{z}$ [$u,u-v,\bar{w}$]
3 b ..2	$x,\bar{x},1/6$ [$u,\bar{u},0$]	$x,2x,5/6$ [$u,2u,0$]	$2\bar{x},\bar{x},1/2$ [$2\bar{u},\bar{u},0$]
3 a ..2	$x,\bar{x},2/3$ [$u,\bar{u},0$]	$x,2x,1/3$ [$u,2u,0$]	$2\bar{x},\bar{x},0$ [$2\bar{u},\bar{u},0$]

Symmetry of special projections

Along [001] $3m'$ Origin at 0,0,z	Along [100] $p1m'1$ $a^* = c$ Origin at $x,0,1/3$	Along [210] $p211$ $a^* = c$ Origin at $x,x/2,0$
--------------------------------------	---	--

$p3_2121'$

$3121'$

Trigonal

No. 48.2.248

$p3_2121'$

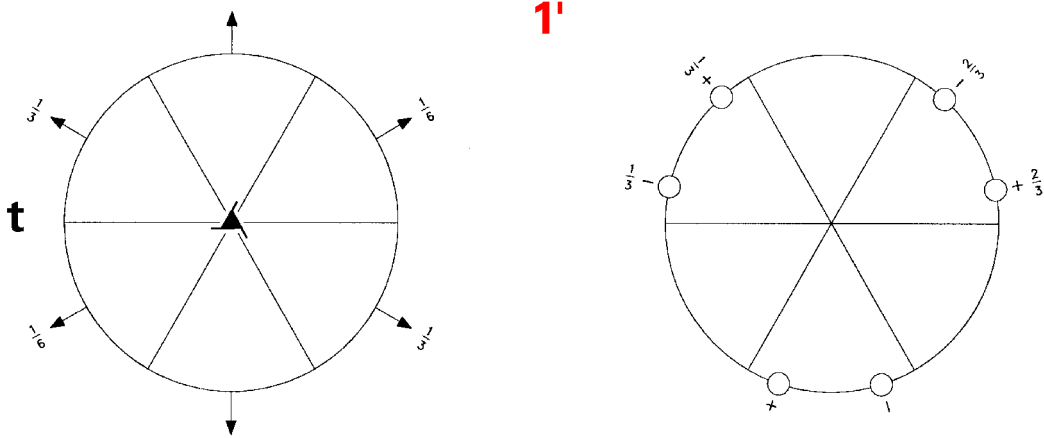

Origin on $21'[210]$ at $3_21(1,1,2)1'$

Asymmetric unit $0 \leq x; 0 \leq y; 0 \leq z \leq 1/2$

Symmetry operations

For $1 +$ set

- | | | |
|--|--|---|
| (1) 1
(1 0,0,0) | (2) $3^+ (0,0,2/3) \ 0,0,z$
(3_z 0,0,2/3) | (3) $3^- (0,0,1/3) \ 0,0,z$
(3_z^{-1} 0,0,1/3) |
| (4) $2 \ x,\bar{x},1/6$
(2_3 0,0,1/3) | (5) $2 \ x,2x,1/3$
(2_2 0,0,2/3) | (6) $2 \ 2x,x,0$
(2_1 0,0,0) |

For $1' +$ set

- | | | |
|--|--|---|
| (1) $1'$
(1 0,0,0)' | (2) $3^{+'} (0,0,2/3) \ 0,0,z$
(3_z 0,0,2/3)' | (3) $3^{-'} (0,0,1/3) \ 0,0,z$
(3_z^{-1} 0,0,1/3)' |
| (4) $2'$ $x,\bar{x},1/6$
(2_3 0,0,1/3)' | (5) $2'$ $x,2x,1/3$
(2_2 0,0,2/3)' | (6) $2'$ $2x,x,0$
(2_1 0,0,0)' |

Generators selected (1); $t(0,0,1)$; (2); (4); $1'$

Positions

Multiplicity, Wyckoff letter, Site symmetry	Coordinates		
		$1+$	$1'+$
6 c $11'$	(1) x,y,z [0,0,0]	(2) $\bar{y},x-y,z+2/3$ [0,0,0]	(3) $\bar{x}+y,\bar{x},z+1/3$ [0,0,0]
	(4) $\bar{y},\bar{x},\bar{z}+1/3$ [0,0,0]	(5) $\bar{x}+y,y,\bar{z}+2/3$ [0,0,0]	(6) $x,x-y,\bar{z}$ [0,0,0]
3 b $..21'$	$x,\bar{x},1/6$ [0,0,0]	$x,2x,5/6$ [0,0,0]	$2\bar{x},\bar{x},1/2$ [0,0,0]
3 a $..21'$	$x,\bar{x},2/3$ [0,0,0]	$x,2x,1/3$ [0,0,0]	$2\bar{x},\bar{x},0$ [0,0,0]

Symmetry of special projections

Along [001] $3m1'$	Along [100] $p1m11'$	Along [210] $p2111'$
Origin at 0,0,z	$a^* = c$ Origin at $x,0,1/3$	$a^* = c$ Origin at $x,x/2,0$

$p3_212'$

$312'$

Trigonal

No. 48.3.249

$p3_212'$

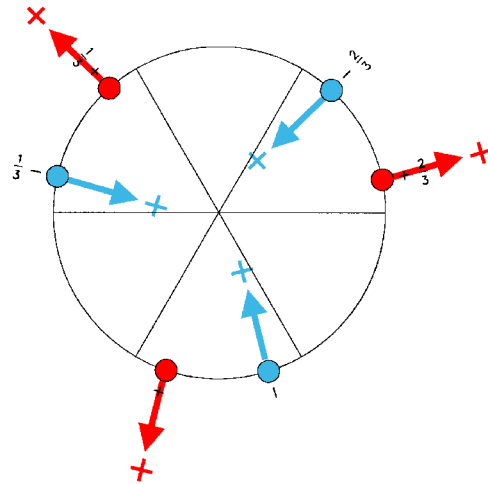
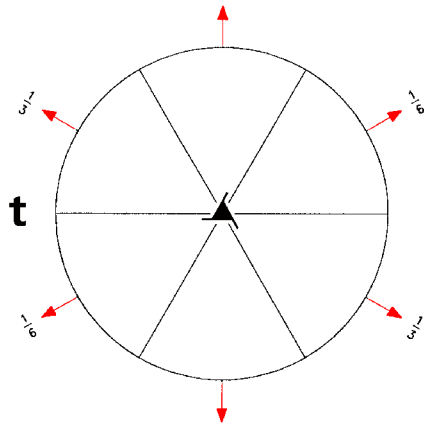

Origin on $2'[210]$ at $3_21(1,1,2')$

Asymmetric unit $0 \leq x$; $0 \leq y$; $0 \leq z \leq 1/2$

Symmetry operations

(1) 1
(1|0,0,0)

(2) $3^+ (0,0,2/3) \ 0,0,z$
 $(3_2|0,0,2/3)$

(3) $3^- (0,0,1/3) \ 0,0,z$
 $(3_2^{-1}|0,0,1/3)$

(4) $2' \ x, \bar{x}, 1/6$
 $(2_3|0,0,1/3)'$

(5) $2' \ x, 2x, 1/3$
 $(2_2|0,0,2/3)'$

(6) $2' \ 2x, x, 0$
 $(2_1|0,0,0)'$

Generators selected (1); $t(0,0,1)$; (2); (4)

Positions

Multiplicity, Wyckoff letter, Site symmetry	Coordinates		
	(1) x,y,z [u,v,w]	(2) $\bar{y},x-y,z+2/3$ [$\bar{v},u-v,w$]	(3) $\bar{x}+y,\bar{x},z+1/3$ [$\bar{u}+v,\bar{u},w$]
6 c 1	(4) $\bar{y},\bar{x},\bar{z}+1/3$ [v,u,w]	(5) $\bar{x}+y,y,\bar{z}+2/3$ [u-v, \bar{v},w]	(6) $x,x-y,\bar{z}$ [$\bar{u},\bar{u}+v,w$]
3 b ..2'	$x,\bar{x},1/6$ [u,u,w]	$x,2x,5/6$ [$\bar{u},0,w$]	$2\bar{x},\bar{x},1/2$ [0, \bar{u},w]
3 a ..2'	$x,\bar{x},2/3$ [u,u,w]	$x,2x,1/3$ [$\bar{u},0,w$]	$2\bar{x},\bar{x},0$ [0, \bar{u},w]

Symmetry of special projections

Along [001] 3m	Along [100] $\rho 1m1$ $a^* = c$	Along [210] $\rho 2'11$ $a^* = c$
Origin at 0,0,z	Origin at $x,0,1/3$	Origin at $x,x/2,0$

$p_{2c}3_112$

3121'

Trigonal

No. 48.4.250

$p_{2c}3_112$

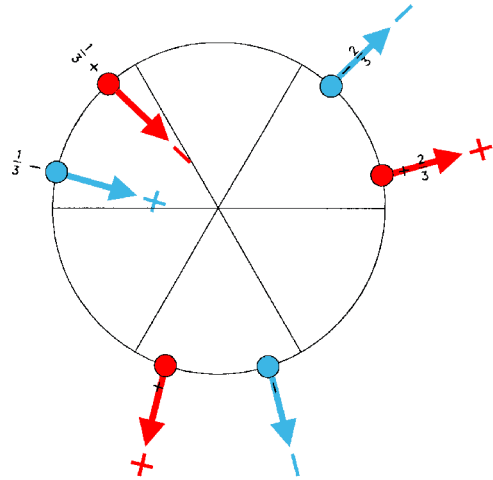
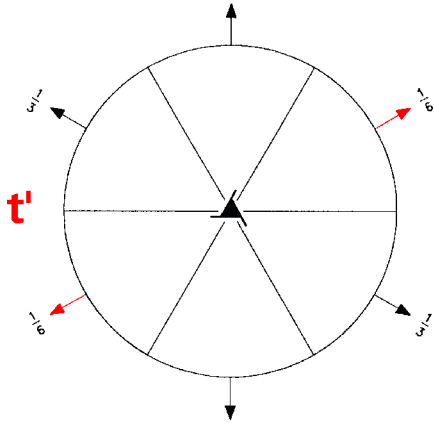

Origin on $2[210]$ at $3_21(1,1,2)$

Asymmetric unit $0 \leq x$; $0 \leq y$; $0 \leq z \leq 1/2$

Symmetry operations

For $(0,0,0)$ + set

- | | | |
|--|--|--|
| (1) 1
(1 0,0,0) | (2) 3^+ (0,0,2/3) 0,0,z
(3_2 0,0,2/3) | (3) 3^- (0,0,1/3) 0,0,z
(3_2^{-1} 0,0,1/3)' |
| (4) $2'$ x, \bar{x} ,1/6
(2_3 0,0,1/3)' | (5) 2 x,2x,1/3
(2_2 0,0,2/3) | (6) 2 2x,x,0
(2_1 0,0,0) |

For $(0,0,1)'$ + set

- | | | |
|--|---|---|
| (1) t' (0,0,1)
(1 0,0,0)' | (2) 3^{+} (0,0,5/3) 0,0,z
(3_2 0,0,5/3)' | (3) 3^- (0,0,4/3) 0,0,z
(3_2^{-1} 0,0,4/3) |
| (4) 2 x, \bar{x} ,2/3
(2_3 0,0,4/3) | (5) $2'$ x,2x,5/6
(2_2 0,0,5/3)' | (6) $2'$ 2x,x,1/2
(2_1 0,0,1)' |

Generators selected (1); $t(0,0,1)'$; (2); (4)

Positions

Multiplicity, Wyckoff letter, Site symmetry	Coordinates		
		$(0,0,0)_+$	$(0,0,1)'$ +
6 c 1	(1) x,y,z [u,v,w]	(2) $\bar{y},x-y,z+2/3$ [$\bar{v},u-v,w$]	(3) $\bar{x}+y,\bar{x},z+1/3$ [u-v,u, \bar{w}]
	(4) $\bar{y},\bar{x},\bar{z}+1/3$ [v,u,w]	(5) $\bar{x}+y,y,\bar{z}+2/3$ [$\bar{u}+v,v,\bar{w}$]	(6) $x,x-y,\bar{z}$ [u,u-v, \bar{w}]
3 b ..2'	$x,\bar{x},1/6$ [u,u,w]	$x,2x,5/6$ [$\bar{u},0,w$]	$2\bar{x},\bar{x},1/2$ [0,u, \bar{w}]
3 a ..2	$x,\bar{x},2/3$ [u, $\bar{u},0$]	$x,2x,1/3$ [$\bar{u},0,0$]	$2\bar{x},\bar{x},0$ [0, $\bar{u},0$]

Symmetry of special projections

Along [001] $3m1'$	Along [100] $p_{2a^*} 1m'1$	Along [210] $p_{2a^*} 211$
Origin at 0,0,z	$a^* = c$ Origin at x,0,1/3	$a^* = c$ Origin at x,x/2,0

$p3m1$

No. 49.1.251

$3m1$

$p3m1$

Trigonal

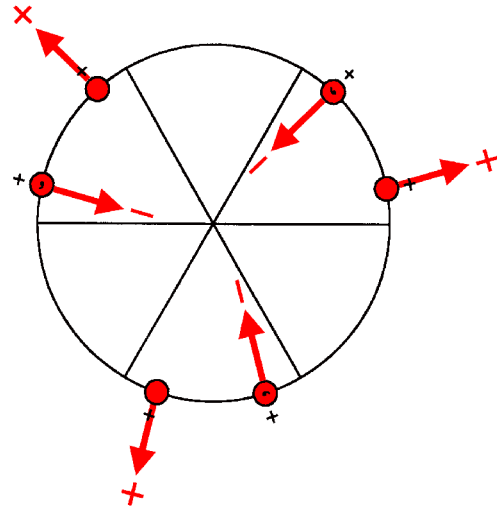
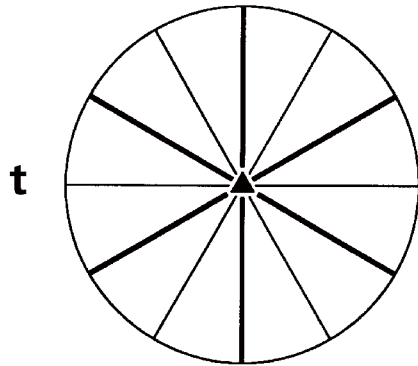

Origin on $3m1$

Asymmetric unit $0 \leq x; 0 \leq y; 0 \leq z \leq 1; x \leq 2y; y \leq 2x$

Symmetry operations

(1) 1
(1|0,0,0)

(2) 3^+ 0,0,z
(3_z |0,0,0)

(3) 3^- 0,0,z
(3_z^{-1} |0,0,0)

(4) m x, \bar{x}, z
(m_{xy} |0,0,0)

(5) m $x, 2x, z$
(m_x |0,0,0)

(6) m $2x, x, z$
(m_y |0,0,0)

Generators selected (1); $t(0,0,1)$; (2); (4)

Positions

Multiplicity, Wyckoff letter, Site symmetry	Coordinates		
	(1) x,y,z [u,v,w]	(2) $\bar{y},x-y,z$ [$\bar{v},u-v,w$]	(3) $\bar{x}+y,\bar{x},z$ [$\bar{u}+v,\bar{u},w$]
6 c 1	(4) \bar{y},\bar{x},z [v,u,\bar{w}]	(5) $\bar{x}+y,y,z$ [$u-v,\bar{v},\bar{w}$]	(6) $x,x-y,z$ [$\bar{u},\bar{u}+v,\bar{w}$]
3 b .m.	x,\bar{x},z [$u,u,0$]	$x,2x,z$ [$\bar{u},0,0$]	$2\bar{x},\bar{x},z$ [$0,\bar{u},0$]
1 a 3m.	$0,0,z$ [$0,0,0$]		

Symmetry of special projections

Along [001] 3m	Along [100] $p11'$ $a^* = c$	Along [210] $p11m$ $a^* = c$
Origin at 0,0,z	Origin at x,0,0	Origin at x,x/2,0

$p3m11'$

No. 49.2.252

$3m11'$

$p3m11'$

Trigonal

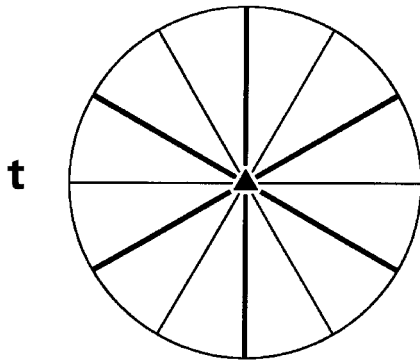

1'

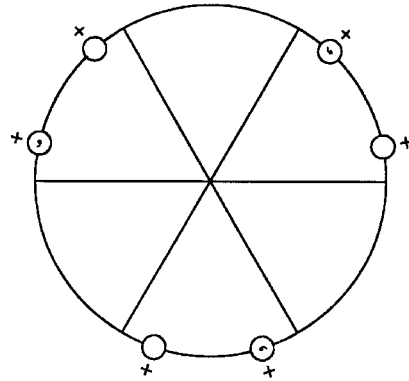

Origin on $3m11'$

Asymmetric unit $0 \leq x; 0 \leq y; 0 \leq z \leq 1; x \leq 2y; y \leq 2x$

Symmetry operations

For 1 + set

(1) 1

$(1|0,0,0)$

(2) 3^+ 0,0,z

$(3_z|0,0,0)$

(3) 3^- 0,0,z

$(3_z^{-1}|0,0,0)$

(4) m x, \bar{x}, z

$(m_{xy}|0,0,0)$

(5) m $x, 2x, z$

$(m_x|0,0,0)$

(6) m $2x, x, z$

$(m_y|0,0,0)$

For 1' + set

(1) 1'

$(1|0,0,0)'$

(2) $3^{+ '}$ 0,0,z

$(3_z|0,0,0)'$

(3) $3^{- '}$ 0,0,z

$(3_z^{-1}|0,0,0)'$

(4) m' x, \bar{x}, z

$(m_{xy}|0,0,0)'$

(5) m' $x, 2x, z$

$(m_x|0,0,0)'$

(6) m' $2x, x, z$

$(m_y|0,0,0)'$

Generators selected (1); t(0,0,1); (2); (4); 1'

Positions

Multiplicity, Wyckoff letter, Site symmetry	Coordinates		
	1+	1' +	
6 c 11'	(1) x,y,z [0,0,0]	(2) \bar{y} ,x-y,z [0,0,0]	(3) \bar{x} +y, \bar{x} ,z [0,0,0]
	(4) \bar{y} , \bar{x} ,z [0,0,0]	(5) \bar{x} +y,y,z [0,0,0]	(6) x,x-y,z [0,0,0]
3 b .m.1'	x, \bar{x} ,z [0,0,0]	x,2x,z [0,0,0]	2 \bar{x} , \bar{x} ,z [0,0,0]
1 a 3m.1'	0,0,z [0,0,0]		

Symmetry of special projections

Along [001] 3m1'	Along [100] p11'	Along [210] p11m1'
Origin at 0,0,z	a* = c Origin at x,0,0	a* = c Origin at x,x/2,0

$\rho 3m'1$

No. 49.3.253

$3m'1$

$\rho 3m'1$

Trigonal

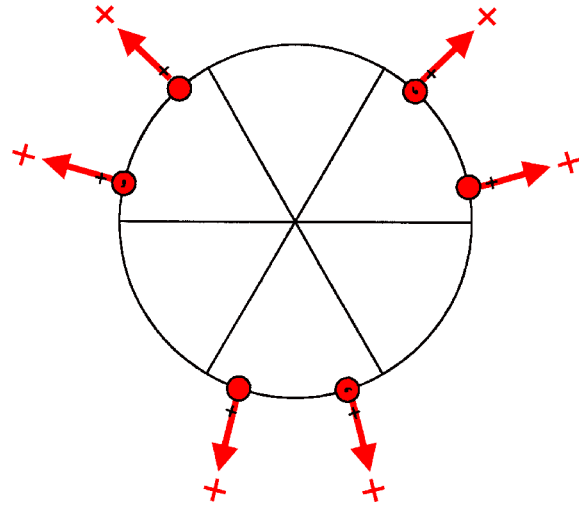
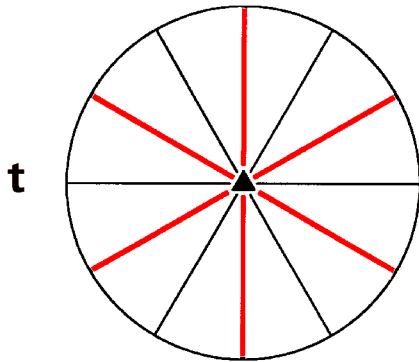

Origin on $3m'1$

Asymmetric unit $0 \leq x; 0 \leq y; 0 \leq z \leq 1; x \leq 2y; y \leq 2x$

Symmetry operations

(1) 1
(1|0,0,0)

(2) 3^+ 0,0,z
(3_z |0,0,0)

(3) 3^- 0,0,z
(3_z^{-1} |0,0,0)

(4) m' x, \bar{x}, z
(m_{xy} |0,0,0)'

(5) m' $x, 2x, z$
(m_x |0,0,0)'

(6) m' $2x, x, z$
(m_y |0,0,0)'

Generators selected (1); $t(0,0,1)$; (2); (4)

Positions

Multiplicity, Wyckoff letter, Site symmetry	Coordinates		
	(1) x,y,z [u,v,w]	(2) $\bar{y},x-y,z$ [$\bar{v},u-v,w$]	(3) $\bar{x}+y,\bar{x},z$ [$\bar{u}+v,\bar{u},w$]
6 c 1	(4) \bar{y},\bar{x},z [\bar{v},\bar{u},w]	(5) $\bar{x}+y,y,z$ [$\bar{u}+v,v,w$]	(6) $x,x-y,z$ [$u,u-v,w$]
3 b .m'	x,\bar{x},z [u,\bar{u},w]	$x,2x,z$ [$u,2u,w$]	$2\bar{x},\bar{x},z$ [$2\bar{u},\bar{u},w$]
1 a 3m'	$0,0,z$ [$0,0,w$]		

Symmetry of special projections

Along [001] $3m'$ Origin at $0,0,z$	Along [100] $\rho 1$ $a^* = c$ Origin at $x,0,0$	Along [210] $\rho 11m'$ $a^* = c$ Origin at $x,x/2,0$

$\rho_{2c}3m'1$

$3m11'$

Trigonal

No. 49.4.254

$\rho_{2c}3m'1$

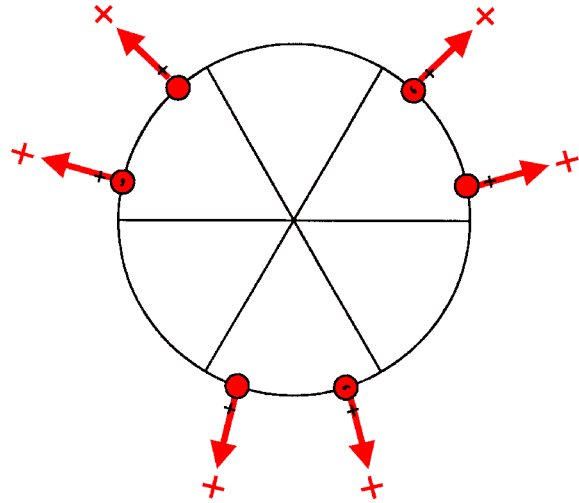
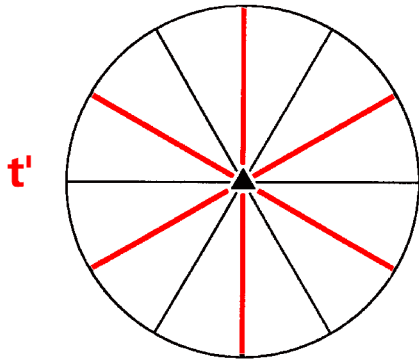

Origin on $3m'1$

Asymmetric unit $0 \leq x; 0 \leq y; 0 \leq z \leq 1; x \leq 2y; y \leq 2x$

Symmetry operations

For $(0,0,0)$ + set

(1) 1

$(1|0,0,0)$

(2) $3^+ 0,0,z$

$(3_z|0,0,0)$

(3) $3^- 0,0,z$

$(3_z^{-1}|0,0,0)$

(4) $m' x,\bar{x},z$

$(m_{xy}|0,0,0)'$

(5) $m' x,2x,z$

$(m_x|0,0,0)'$

(6) $m' 2x,x,z$

$(m_y|0,0,0)'$

For $(0,0,1)'$ + set

(1) $t' (0,0,1)$

$(1|0,0,1)'$

(2) $3^{+'} (0,0,1) 0,0,z$

$(3_z|0,0,1)'$

(3) $3^{-'} (0,0,1) 0,0,z$

$(3_z^{-1}|0,0,1)'$

(4) $c (0,0,1) x,\bar{x},z$

$(m_{xy}|0,0,1)$

(5) $c (0,0,1) x,2x,z$

$(m_x|0,0,1)$

(6) $c (0,0,1) 2x,x,z$

$(m_y|0,0,1)$

Continued

No. 49.4.254

 $p_{2c} 3m'1$ Generators selected (1); $t(0,0,1)'$; (2); (4)

Positions

Multiplicity, Wyckoff letter, Site symmetry	Coordinates		
		$(0,0,0)_+$	$(0,0,1)'$ +
6 c 1	(1) $x,y,z [u,v,w]$	(2) $\bar{y},x-y,z [\bar{v},u-v,w]$	(3) $\bar{x}+y,\bar{x},z [\bar{u}+v,\bar{u},w]$
	(4) $\bar{y},\bar{x},z [\bar{v},\bar{u},w]$	(5) $\bar{x}+y,y,z [\bar{u}+v,v,w]$	(6) $x,x-y,z [u,u-v,w]$
3 b $.m'$	$x,\bar{x},z [u,\bar{u},w]$	$x,2x,z [u,2u,w]$	$2\bar{x},\bar{x},z [2\bar{u},\bar{u},w]$
1 a $3m'$	$0,0,z [0,0,w]$		

Symmetry of special projections

Along [001] $3m'1$	Along [100] $p_{2a^*} 1$ $a^* = c$	Along [210] $p_{2a^*} 11m'$ $a^* = c$
Origin at $0,0,z$	Origin at $x,0,0$	Origin at $x,x/2,0$

$\rho_{2c}3m1$

$3m11'$

Trigonal

No. 49.5.255

$\rho_{2c}3m1$

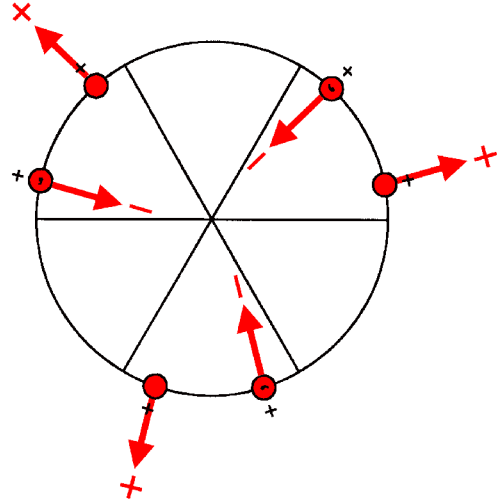
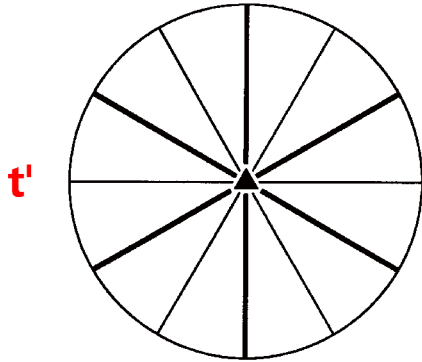

Origin on $3m1$

Asymmetric unit $0 \leq x; 0 \leq y; 0 \leq z \leq 1; x \leq 2y; y \leq 2x$

Symmetry operations

For $(0,0,0)$ + set

- | | | |
|---|-------------------------------------|---|
| (1) 1
(1 0,0,0) | (2) 3^+ 0,0,z
(3_z 0,0,0) | (3) 3^- 0,0,z
(3_z^{-1} 0,0,0) |
| (4) m x, \bar{x}, z
(m_{xy} 0,0,0) | (5) m $x, 2x, z$
(m_x 0,0,0) | (6) m $2x, x, z$
(m_y 0,0,0) |

For $(0,0,1)'$ + set

- | | | |
|---|---|--|
| (1) t' (0,0,1)
(1 0,0,1)' | (2) $3^{+ '}$ (0,0,1) 0,0,z
(3_z 0,0,1)' | (3) $3^{- '}$ (0,0,1) 0,0,z
(3_z^{-1} 0,0,1)' |
| (4) c' (0,0,1) x, \bar{x}, z
(m_{xy} 0,0,1)' | (5) c' (0,0,1) $x, 2x, z$
(m_x 0,0,1)' | (6) c' (0,0,1) $2x, x, z$
(m_y 0,0,1)' |

Generators selected (1); $t(0,0,1)'$; (2); (4)

Positions

Multiplicity, Wyckoff letter, Site symmetry	Coordinates		
		$(0,0,0)_+$	$(0,0,1)'$ +
6 c 1	(1) $x,y,z [u,v,w]$	(2) $\bar{y},x-y,z [\bar{v},u-v,w]$	(3) $\bar{x}+y,\bar{x},z [\bar{u}+v,\bar{u},w]$
	(4) $\bar{y},\bar{x},z [v,u,\bar{w}]$	(5) $\bar{x}+y,y,z [u-v,\bar{v},\bar{w}]$	(6) $x,x-y,z [\bar{u},\bar{u}+v,\bar{w}]$
3 b .m.	$x,\bar{x},z[u,u,0]$	$x,2x,z [\bar{u},0,0]$	$2\bar{x},\bar{x},z [0,\bar{u},0]$
1 a 3m.	$0,0,z [0,0,0]$		

Symmetry of special projections

Along [001] $3m1'$	Along [100] $p11'$	Along [210] $p_{2a^*} 11m$
Origin at 0,0,z	$a^* = c$ Origin at $x,0,0$	$a^* = c$ Origin at $x,x/2,0$

$p3c1$

No. 50.1.256

$3m1$

$p3c1$

Trigonal

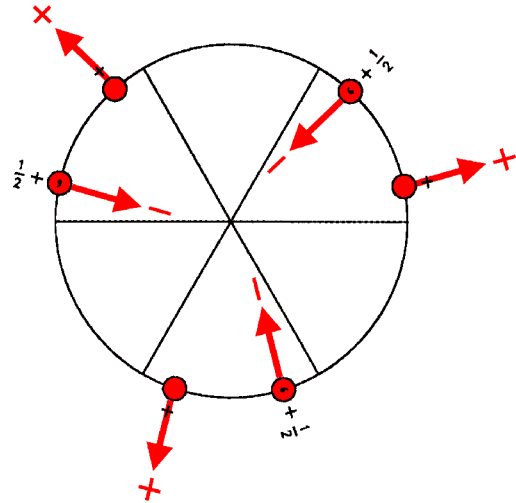
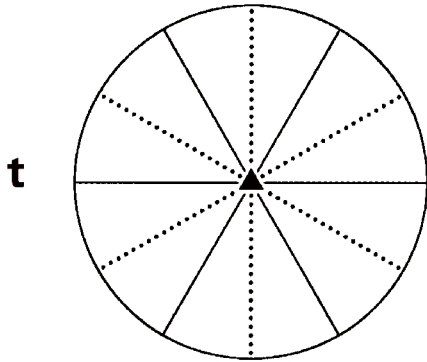

Origin on $3c1$

Asymmetric unit $0 \leq x$; $0 \leq y$; $0 \leq z \leq 1/2$

Symmetry operations

(1) 1
(1|0,0,0)

(2) 3^+ 0,0,z
(3_z |0,0,0)

(3) 3^- 0,0,z
(3_z^{-1} |0,0,0)

(4) c (0,0,1/2) x, \bar{x}, z
(m_{xy} |0,0,1/2)

(5) c (0,0,1/2) $x, 2x, z$
(m_x |0,0,1/2)

(6) c (0,0,1/2) $2x, x, z$
(m_y |0,0,1/2)

Continued

No. 50.1.256

$p3c1$

Generators selected (1); $t(0,0,1)$; (2); (4)

Positions

	Coordinates		
Multiplicity, Wyckoff letter, Site symmetry			
6 b 1	(1) x,y,z [u,v,w]	(2) $\bar{y},x-y,z$ [$\bar{v},u-v,w$]	(3) $\bar{x}+y,\bar{x},z$ [$\bar{u}+v,\bar{u},w$]
	(4) $\bar{y},\bar{x},z+1/2$ [v,u,\bar{w}]	(5) $\bar{x}+y,y,z+1/2$ [$u-v,\bar{v},\bar{w}$]	(6) $x,x-y,z+1/2$ [$\bar{u},\bar{u}+v,\bar{w}$]
1 a 3..	$0,0,z$ [$0,0,w$]	$0,0,z+1/2$ [$0,0,\bar{w}$]	

Symmetry of special projections

Along [001] $3m$	Along [100] $p_{2a^*} 1$	Along [210] $p11g$
Origin at $0,0,z$	$a^* = c/2$ Origin at $x,0,0$	$a^* = c$ Origin at $x,x/2,0$

$p3c11'$

$3m11'$

Trigonal

No. 50.2.257

$p3c11'$

1'

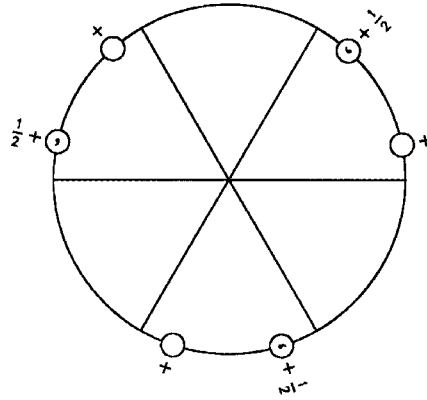
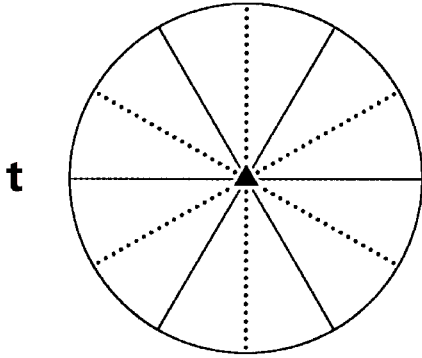

Origin on $3c11'$

Asymmetric unit $0 \leq x; 0 \leq y; 0 \leq z \leq 1/2$

Symmetry operations

For $1 +$ set

(1) 1
($1|0,0,0$)

(2) 3^+ $0,0,z$
($3_z|0,0,0$)

(3) 3^- $0,0,z$
($3_z^{-1}|0,0,0$)

(4) c $(0,0,1/2)$ x, \bar{x}, z
($m_{xy}|0,0,1/2$)

(5) c $(0,0,1/2)$ $x, 2x, z$
($m_x|0,0,1/2$)

(6) c $(0,0,1/2)$ $2x, x, z$
($m_y|0,0,1/2$)

For $1' +$ set

(1) $1'$
($1|0,0,0$)'

(2) $3^{+'}$ $0,0,z$
($3_z|0,0,0$)'

(3) $3^{-'}$ $0,0,z$
($3_z^{-1}|0,0,0$)'

(4) c' $(0,0,1/2)$ x, \bar{x}, z
($m_{xy}|0,0,1/2$)'

(5) c' $(0,0,1/2)$ $x, 2x, z$
($m_x|0,0,1/2$)'

(6) c' $(0,0,1/2)$ $2x, x, z$
($m_y|0,0,1/2$)'

Continued

No. 50.2.257

$p3c11'$

Generators selected (1); $t(0,0,1)$; (2); (4); $1'$

Positions

Multiplicity, Wyckoff letter, Site symmetry	Coordinates		
	$1+$	$1'+$	
6 b $11'$	(1) x,y,z [0,0,0]	(2) $\bar{y},x-y,z$ [0,0,0]	(3) $\bar{x}+y,\bar{x},z$ [0,0,0]
	(4) $\bar{y},\bar{x},z+1/2$ [0,0,0]	(5) $\bar{x}+y,y,z+1/2$ [0,0,0]	(6) $x,x-y,z+1/2$ [0,0,0]
1 a $3..1'$	$0,0,z$ [0,0,0]	$0,0,z+1/2$ [0,0,0]	

Symmetry of special projections

Along [001] $3m1'$	Along [100] $p11'$ $a^* = c/2$	Along [210] $p11g1'$ $a^* = c$
Origin at 0,0,z	Origin at x,0,0	Origin at x,x/2,0

$p3c'1$

No. 50.3.258

$3m'1$

$p3c'1$

Trigonal

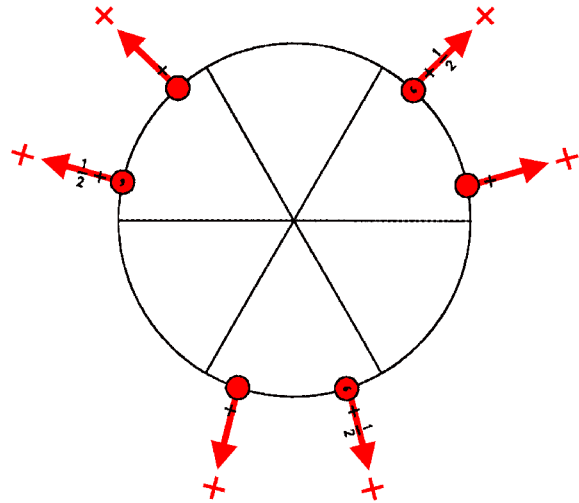
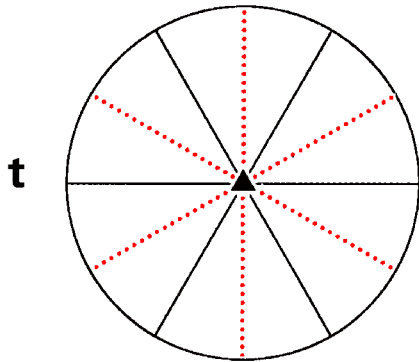

Origin on $3c'1$

Asymmetric unit $0 \leq x$; $0 \leq y$; $0 \leq z \leq 1/2$

Symmetry operations

(1) 1
(1|0,0,0)

(2) 3^+ 0,0,z
(3_z |0,0,0)

(3) 3^- 0,0,z
(3_z^{-1} |0,0,0)

(4) c' (0,0,1/2) x, \bar{x}, z
(m_{xy} |0,0,1/2)'

(5) c' (0,0,1/2) $x, 2x, z$
(m_x |0,0,1/2)'

(6) c' (0,0,1/2) $2x, x, z$
(m_y |0,0,1/2)'

Continued

No. 50.3.258

$p3c'1$

Generators selected (1); $t(0,0,1)$; (2); (4)

Positions

	Coordinates		
Multiplicity, Wyckoff letter, Site symmetry			
6 b 1	(1) $x,y,z [u,v,w]$	(2) $\bar{y},x-y,z [\bar{v},u-v,w]$	(3) $\bar{x}+y,\bar{x},z [\bar{u}+v,\bar{u},w]$
	(4) $\bar{y},\bar{x},z+1/2 [\bar{v},\bar{u},w]$	(5) $\bar{x}+y,y,z+1/2 [\bar{u}+v,v,w]$	(6) $x,x-y,z+1/2 [u,u-v,w]$
1 a 3..	$0,0,z [0,0,w]$	$0,0,z+1/2 [0,0,w]$	

Symmetry of special projections

Along [001] $3m'$	Along [100] $p1$ $a^* = c/2$	Along [210] $p11g'$ $a^* = c$
Origin at $0,0,z$	Origin at $x,0,0$	Origin at $x,x/2,0$

$p\bar{3}1m$

No. 51.1.259

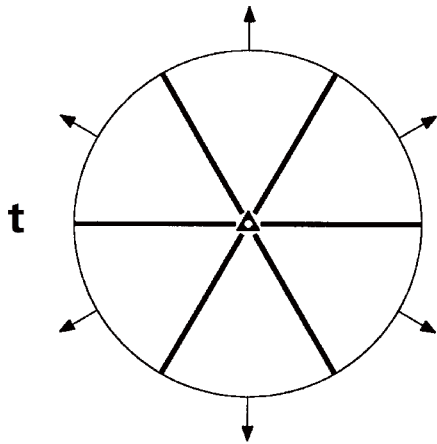

$\bar{3}1m$

$p\bar{3}12/m$

Trigonal

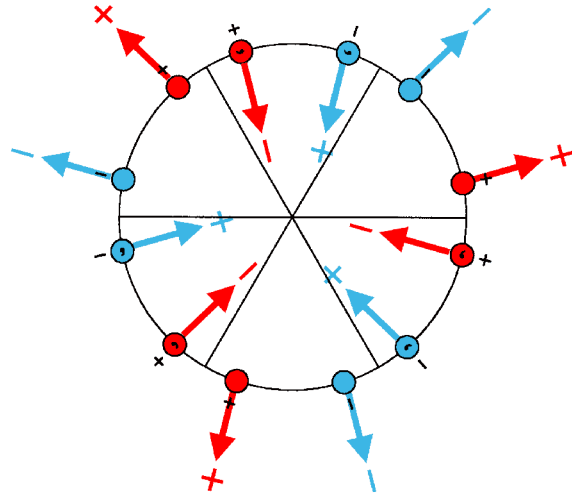

Origin at center ($\bar{3}1m$)

Asymmetric unit $0 \leq x; 0 \leq y; 0 \leq z \leq 1/2; y \leq x$

Symmetry operations

- | | | |
|--|---|--|
| (1) 1
(1 0,0,0) | (2) 3^+ 0,0,z
(3_z 0,0,0) | (3) 3^- 0,0,z
(3_z^{-1} 0,0,0) |
| (4) 2 x, \bar{x} ,0
(2_3 0,0,0) | (5) 2 x,2x,0
(2_2 0,0,0) | (6) 2 2x,x,0
(2_1 0,0,0) |
| (7) $\bar{1}$ 0,0,0
($\bar{1}$ 0,0,0) | (8) $\bar{3}^+$ 0,0,z; 0,0,0
($\bar{3}_z$ 0,0,0) | (9) $\bar{3}^-$ 0,0,z; 0,0,0
($\bar{3}_z^{-1}$ 0,0,0) |
| (10) m x,x,z
(m_3 0,0,0) | (11) m x,0,z
(m_2 0,0,0) | (12) m 0,y,z
(m_1 0,0,0) |

Generators selected (1); $t(0,0,1)$; (2); (4); (7)

Positions

	Coordinates		
Multiplicity, Wyckoff letter, Site symmetry			
12 g 1	(1) $x,y,z [u,v,w]$	(2) $\bar{y},x-y,z [\bar{v},u-v,w]$	(3) $\bar{x}+y,\bar{x},z [\bar{u}+v,\bar{u},w]$
	(4) $\bar{y},\bar{x},\bar{z} [\bar{v},\bar{u},\bar{w}]$	(5) $\bar{x}+y,y,\bar{z} [\bar{u}+v,v,\bar{w}]$	(6) $x,x-y,\bar{z} [u,u-v,\bar{w}]$
	(7) $\bar{x},\bar{y},\bar{z} [u,v,w]$	(8) $y,\bar{x}+y,\bar{z} [\bar{v},u-v,w]$	(9) $x-y,x,\bar{z} [\bar{u}+v,\bar{u},w]$
	(10) $y,x,z [\bar{v},\bar{u},\bar{w}]$	(11) $x-y,\bar{y},z [\bar{u}+v,v,\bar{w}]$	(12) $\bar{x},\bar{x}+y,z [u,u-v,\bar{w}]$
6 f ..m	$x,0,z [u,2u,0]$	$0,x,z [2\bar{u},\bar{u},0]$	$\bar{x},\bar{x},z [u,\bar{u},0]$
	$0,\bar{x},\bar{z} [2\bar{u},\bar{u},0]$	$\bar{x},0,\bar{z} [u,2u,0]$	$x,x,\bar{z} [u,\bar{u},0]$
6 e ..2	$x,\bar{x},1/2 [u,\bar{u},0]$	$x,2x,1/2 [u,2u,0]$	$2\bar{x},\bar{x},1/2 [2\bar{u},\bar{u},0]$
	$\bar{x},x,1/2 [u,\bar{u},0]$	$\bar{x},2\bar{x},1/2 [2\bar{u},\bar{u},0]$	$2x,x,1/2 [u,2u,0]$
6 d ..2	$x,\bar{x},0 [u,\bar{u},0]$	$x,2x,0 [u,2u,0]$	$2\bar{x},\bar{x},0 [2\bar{u},\bar{u},0]$
	$\bar{x},x,0 [u,\bar{u},0]$	$\bar{x},2\bar{x},0 [2\bar{u},\bar{u},0]$	$2x,x,0 [u,2u,0]$
2 c 3.m	$0,0,z [0,0,0]$	$0,0,\bar{z} [0,0,0]$	
1 b $\bar{3}.m$	$0,0,1/2 [0,0,0]$		
1 a $\bar{3}.m$	$0,0,0 [0,0,0]$		

Symmetry of special projections

Along [001] $6'm'm$	Along [100] $p2'm'm$	Along [210] $p2111'$
Origin at 0,0,z	$a^* = c$ Origin at x,0,0	$a^* = c$ Origin at x,x/2,0

$p\bar{3}1m1'$

$\bar{3}1m1'$

Trigonal

No. 51.2.260

$p\bar{3}12/m1'$

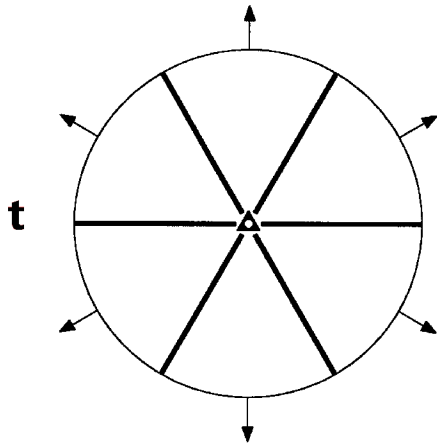

1'

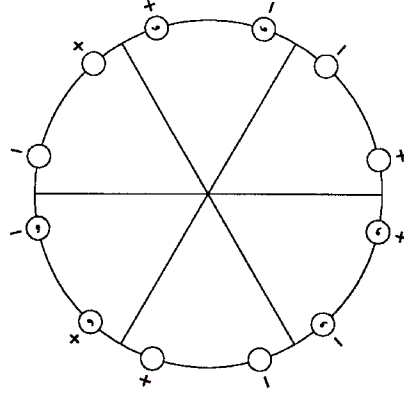

Origin at center ($\bar{3}1m1'$)

Asymmetric unit $0 \leq x; 0 \leq y; 0 \leq z \leq 1/2; y \leq x$

Symmetry operations

For 1 + set

- | | | |
|--|---|--|
| (1) 1
(1 0,0,0) | (2) 3^+ 0,0,z
(3_z 0,0,0) | (3) 3^- 0,0,z
(3_z^{-1} 0,0,0) |
| (4) 2 x, \bar{x} ,0
(2_3 0,0,0) | (5) 2 x,2x,0
(2_2 0,0,0) | (6) 2 2x,x,0
(2_1 0,0,0) |
| (7) $\bar{1}$ 0,0,0
($\bar{1}$ 0,0,0) | (8) $\bar{3}^+$ 0,0,z; 0,0,0
($\bar{3}_z$ 0,0,0) | (9) $\bar{3}^-$ 0,0,z; 0,0,0
($\bar{3}_z^{-1}$ 0,0,0) |
| (10) m x,x,z
(m_3 0,0,0) | (11) m x,0,z
(m_2 0,0,0) | (12) m 0,y,z
(m_1 0,0,0) |

For 1' + set

- | | | |
|--|---|--|
| (1) 1'
(1 0,0,0)' | (2) $3^{+'}$ 0,0,z
(3_z 0,0,0)' | (3) $3^{-'}$ 0,0,z
(3_z^{-1} 0,0,0)' |
| (4) 2' x, \bar{x} ,0
(2_3 0,0,0)' | (5) 2' x,2x,0
(2_2 0,0,0)' | (6) 2' 2x,x,0
(2_1 0,0,0)' |
| (7) $\bar{1}'$ 0,0,0
($\bar{1}'$ 0,0,0) | (8) $\bar{3}^{+'}$ 0,0,z; 0,0,0
($\bar{3}_z$ 0,0,0)' | (9) $\bar{3}^{-'}$ 0,0,z; 0,0,0
($\bar{3}_z^{-1}$ 0,0,0)' |
| (10) m' x,x,z
(m_3 0,0,0)' | (11) m' x,0,z
(m_2 0,0,0)' | (12) m' 0,y,z
(m_1 0,0,0)' |

Generators selected (1); $t(0,0,1)$; (2); (4); (7); $1'$

Positions

Multiplicity, Wyckoff letter, Site symmetry	Coordinates		
	$1+$	$1' +$	
12 g $11'$	(1) x,y,z [0,0,0] (4) \bar{y},\bar{x},\bar{z} [0,0,0] (7) \bar{x},\bar{y},\bar{z} [0,0,0] (10) y,x,z [0,0,0]	(2) $\bar{y},x-y,z$ [0,0,0] (5) $\bar{x}+y,y,\bar{z}$ [0,0,0] (8) $y,\bar{x}+y,\bar{z}$ [0,0,0] (11) $x-y,\bar{y},z$ [0,0,0]	(3) $\bar{x}+y,\bar{x},z$ [0,0,0] (6) $x,x-y,\bar{z}$ [0,0,0] (9) $x-y,x,\bar{z}$ [0,0,0] (12) $\bar{x},\bar{x}+y,z$ [0,0,0]
6 f $\bar{3}m1'$	$x,0,z$ [0,0,0] $0,\bar{x},\bar{z}$ [0,0,0]	$0,x,z$ [0,0,0] $\bar{x},0,\bar{z}$ [0,0,0]	\bar{x},\bar{x},z [0,0,0] x,x,\bar{z} [0,0,0]
6 e $\bar{3}21'$	$x,\bar{x},1/2$ [0,0,0] $\bar{x},x,1/2$ [0,0,0]	$x,2x,1/2$ [0,0,0] $\bar{x},2\bar{x},1/2$ [0,0,0]	$2\bar{x},\bar{x},1/2$ [0,0,0] $2x,x,1/2$ [0,0,0]
6 d $\bar{3}21'$	$x,\bar{x},0$ [0,0,0] $\bar{x},x,0$ [0,0,0]	$x,2x,0$ [0,0,0] $\bar{x},2\bar{x},0$ [0,0,0]	$2\bar{x},\bar{x},0$ [0,0,0] $2x,x,0$ [0,0,0]
2 c $3m1'$	$0,0,z$ [0,0,0]	$0,0,\bar{z}$ [0,0,0]	
1 b $\bar{3}m1'$	$0,0,1/2$ [0,0,0]		
1 a $\bar{3}m1'$	$0,0,0$ [0,0,0]		

Symmetry of special projections

Along [001] $6mm1'$	Along [100] $p2mm1'$	Along [210] $p2111'$
Origin at 0,0,z	$a^* = c$ Origin at $x,0,0$	$a^* = c$ Origin at $x,x/2,0$

$p\bar{3}1m'$

No. 51.3.261

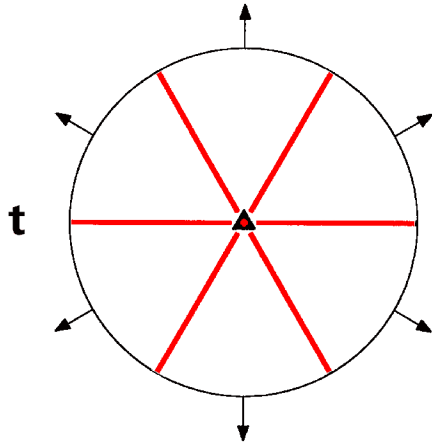

$\bar{3}1m'$

$p\bar{3}12/m'$

Trigonal

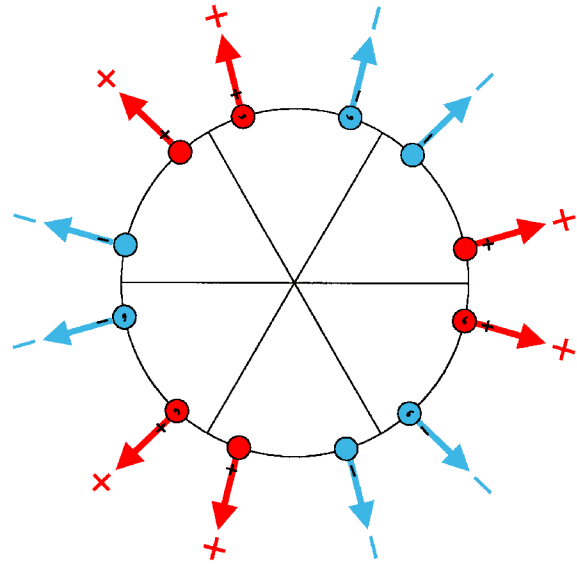

Origin at center ($\bar{3}1m'$)

Asymmetric unit $0 \leq x; 0 \leq y; 0 \leq z \leq 1/2; y \leq x$

Symmetry operations

- | | | |
|---|--|---|
| (1) 1
(1 0,0,0) | (2) 3^+ 0,0,z
(3_z 0,0,0) | (3) 3^- 0,0,z
(3_z^{-1} 0,0,0) |
| (4) 2 x, \bar{x} ,0
(2_3 0,0,0) | (5) 2 x,2x,0
(2_2 0,0,0) | (6) 2 2x,x,0
(2_1 0,0,0) |
| (7) $\bar{1}$ 0,0,0
($\bar{1}$ 0,0,0)' | (8) $\bar{3}^+$ 0,0,z; 0,0,0
($\bar{3}_z$ 0,0,0)' | (9) $\bar{3}^-$ 0,0,z; 0,0,0
($\bar{3}_z^{-1}$ 0,0,0)' |
| (10) m' x,x,z
(m_3 0,0,0)' | (11) m' x,0,z
(m_2 0,0,0)' | (12) m' 0,y,z
(m_1 0,0,0)' |

Generators selected (1); $t(0,0,1)$; (2); (4); (7)

Positions

	Coordinates		
Multiplicity, Wyckoff letter, Site symmetry			
12 g 1	(1) x,y,z [u,v,w]	(2) $\bar{y},x-y,z$ [$\bar{v},u-v,w$]	(3) $\bar{x}+y,\bar{x},z$ [$\bar{u}+v,\bar{u},w$]
	(4) \bar{y},\bar{x},\bar{z} [\bar{v},\bar{u},\bar{w}]	(5) $\bar{x}+y,y,\bar{z}$ [$\bar{u}+v,v,\bar{w}$]	(6) $x,x-y,\bar{z}$ [$u,u-v,\bar{w}$]
	(7) \bar{x},\bar{y},\bar{z} [\bar{u},\bar{v},\bar{w}]	(8) $y,\bar{x}+y,\bar{z}$ [$v,\bar{u}+v,\bar{w}$]	(9) $x-y,x,\bar{z}$ [$u-v,u,\bar{w}$]
	(10) y,x,z [v,u,w]	(11) $x-y,\bar{y},z$ [$u-v,\bar{v},w$]	(12) $\bar{x},\bar{x}+y,z$ [$\bar{u},\bar{u}+v,w$]
6 f $\bar{3}m'$	$x,0,z$ [$u,0,w$]	$0,x,z$ [$0,u,w$]	\bar{x},\bar{x},z [\bar{u},\bar{u},w]
	$0,\bar{x},\bar{z}$ [$0,\bar{u},\bar{w}$]	$\bar{x},0,\bar{z}$ [$\bar{u},0,\bar{w}$]	x,x,\bar{z} [u,u,\bar{w}]
6 e $\bar{3}2$	$x,\bar{x},1/2$ [$u,\bar{u},0$]	$x,2x,1/2$ [$u,2u,0$]	$2\bar{x},\bar{x},1/2$ [$2\bar{u},\bar{u},0$]
	$\bar{x},x,1/2$ [$\bar{u},u,0$]	$\bar{x},2\bar{x},1/2$ [$\bar{u},2\bar{u},0$]	$2x,x,1/2$ [$2u,u,0$]
6 d $\bar{3}2$	$x,\bar{x},0$ [$u,\bar{u},0$]	$x,2x,0$ [$u,2u,0$]	$2\bar{x},\bar{x},0$ [$2\bar{u},\bar{u},0$]
	$\bar{x},x,0$ [$\bar{u},u,0$]	$\bar{x},2\bar{x},0$ [$\bar{u},2\bar{u},0$]	$2x,x,0$ [$2u,u,0$]
2 c $3m'$	$0,0,z$ [$0,0,w$]	$0,0,\bar{z}$ [$0,0,\bar{w}$]	
1 b $\bar{3}'m'$	$0,0,1/2$ [$0,0,0$]		
1 a $\bar{3}'m'$	$0,0,0$ [$0,0,0$]		

Symmetry of special projections

Along [001] $6m'm'$	Along [100] $\rho 2m'm'$	Along [210] $\rho 211$
Origin at $0,0,z$	$a^* = c$ Origin at $x,0,0$	$a^* = c$ Origin at $x,x/2,0$

$p\bar{3}1m'$

No. 51.4.262

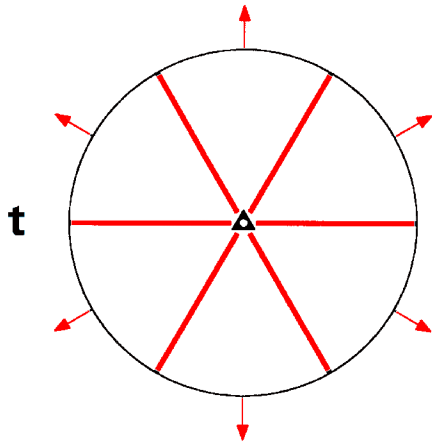

Origin at center ($\bar{3}1m'$)

Asymmetric unit $0 \leq x; 0 \leq y; 0 \leq z \leq 1/2; y \leq x$

Symmetry operations

(1) 1
(1|0,0,0)

(4) $2'$ $x, \bar{x}, 0$
(2_3 |0,0,0)'

(7) $\bar{1}$ $0,0,0$
($\bar{1}$ |0,0,0)

(10) m' x,x,z
(m_3 |0,0,0)'

(2) 3^+ $0,0,z$
(3_2 |0,0,0)

(5) $2'$ $x, 2x, 0$
(2_2 |0,0,0)'

(8) $\bar{3}^+$ $0,0,z; 0,0,0$
($\bar{3}_2$ |0,0,0)

(11) m' $x,0,z$
(m_2 |0,0,0)'

(3) 3^- $0,0,z$
(3_2^{-1} |0,0,0)

(6) $2'$ $2x,x,0$
(2_1 |0,0,0)'

(9) $\bar{3}^-$ $0,0,z; 0,0,0$
($\bar{3}_2^{-1}$ |0,0,0)

(12) m' $0,y,z$
(m_1 |0,0,0)'

$\bar{3}1m'$

$p\bar{3}12'/m'$

Trigonal

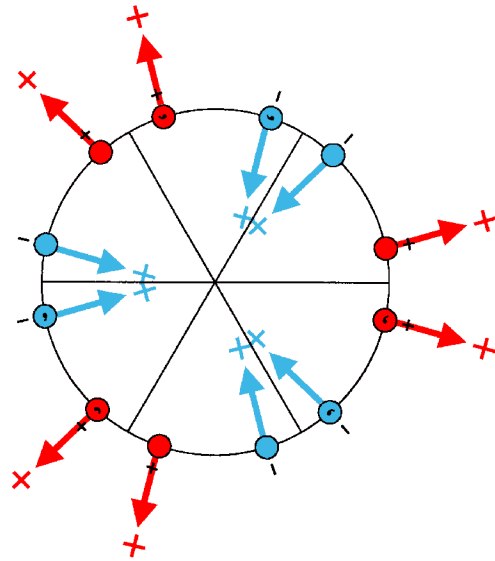

Generators selected (1); $t(0,0,1)$; (2); (4); (7)

Positions

	Coordinates		
Multiplicity, Wyckoff letter, Site symmetry			
12 g 1	(1) x,y,z [u,v,w]	(2) $\bar{y},x-y,z$ [$\bar{v},u-v,w$]	(3) $\bar{x}+y,\bar{x},z$ [$\bar{u}+v,\bar{u},w$]
	(4) \bar{y},\bar{x},\bar{z} [v,u,w]	(5) $\bar{x}+y,y,\bar{z}$ [u-v, \bar{v},w]	(6) $x,x-y,\bar{z}$ [$\bar{u},\bar{u}+v,w$]
	(7) \bar{x},\bar{y},\bar{z} [u,v,w]	(8) $y,\bar{x}+y,\bar{z}$ [$\bar{v},u-v,w$]	(9) $x-y,x,\bar{z}$ [$\bar{u}+v,\bar{u},w$]
	(10) y,x,z [v,u,w]	(11) $x-y,\bar{y},z$ [u-v, \bar{v},w]	(12) $\bar{x},\bar{x}+y,z$ [$\bar{u},\bar{u}+v,w$]
6 f ..m'	$x,0,z$ [u,0,w]	$0,x,z$ [0,u,w]	\bar{x},\bar{x},z [\bar{u},\bar{u},w]
	$0,\bar{x},\bar{z}$ [0,u,w]	$\bar{x},0,\bar{z}$ [u,0,w]	x,x,\bar{z} [\bar{u},\bar{u},w]
6 e ..2'	$x,\bar{x},1/2$ [u,u,w]	$x,2x,1/2$ [$\bar{u},0,w$]	$2\bar{x},\bar{x},1/2$ [0, \bar{u},w]
	$\bar{x},x,1/2$ [u,u,w]	$\bar{x},2\bar{x},1/2$ [$\bar{u},0,w$]	$2x,x,1/2$ [0, \bar{u},w]
6 d ..2'	$x,\bar{x},0$ [u,u,w]	$x,2x,0$ [$\bar{u},0,w$]	$2\bar{x},\bar{x},0$ [0, \bar{u},w]
	$\bar{x},x,0$ [u,u,w]	$\bar{x},2\bar{x},0$ [$\bar{u},0,w$]	$2x,x,0$ [0, \bar{u},w]
2 c 3.m'	$0,0,z$ [0,0,w]	$0,0,\bar{z}$ [0,0,w]	
1 b $\bar{3}.m'$	$0,0,1/2$ [0,0,w]		
1 a $\bar{3}.m'$	$0,0,0$ [0,0,w]		

Symmetry of special projections

Along [001] $6'mm'$	Along [100] $p2'mm'$	Along [210] $p2'11$
Origin at 0,0,z	$a^* = c$ Origin at x,0,0	$a^* = c$ Origin at x,x/2,0

$p\bar{3}1m$

No. 51.5.263

$\bar{3}1m$

$p\bar{3}12'/m$

Trigonal

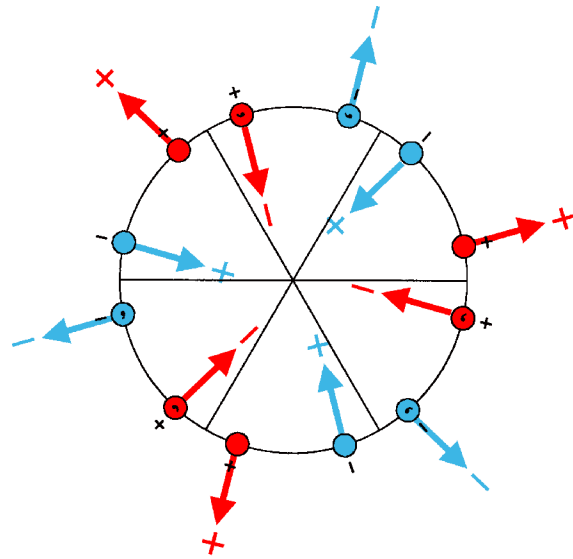
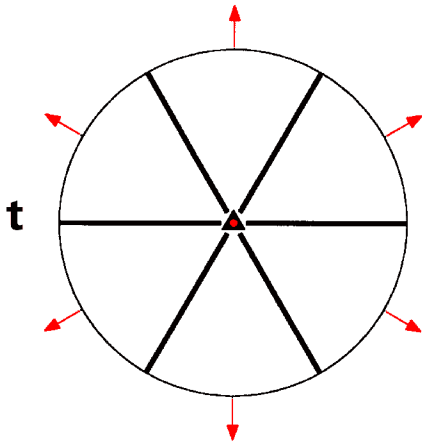

Origin at center ($\bar{3}1m$)

Asymmetric unit $0 \leq x$; $0 \leq y$; $0 \leq z \leq 1/2$; $y \leq x$

Symmetry operations

- | | | |
|--|--|---|
| (1) 1
(1 0,0,0) | (2) 3^+ 0,0,z
(3_z 0,0,0) | (3) 3^- 0,0,z
(3_z^{-1} 0,0,0) |
| (4) $2'$ x, \bar{x} ,0
(2_3 0,0,0)' | (5) $2'$ x,2x,0
(2_2 0,0,0)' | (6) $2'$ 2x,x,0
(2_1 0,0,0)' |
| (7) $\bar{1}$ 0,0,0
($\bar{1}$ 0,0,0)' | (8) $\bar{3}^+$ 0,0,z; 0,0,0
($\bar{3}_z$ 0,0,0)' | (9) $\bar{3}^-$ 0,0,z; 0,0,0
($\bar{3}_z^{-1}$ 0,0,0)' |
| (10) m x,x,z
(m_3 0,0,0) | (11) m x,0,z
(m_2 0,0,0) | (12) m 0,y,z
(m_1 0,0,0) |

Generators selected (1); $t(0,0,1)$; (2); (4); (7)

Positions

	Coordinates		
Multiplicity, Wyckoff letter, Site symmetry			
12 g 1	(1) x,y,z [u,v,w]	(2) $\bar{y},x-y,z$ [$\bar{v},u-v,w$]	(3) $\bar{x}+y,\bar{x},z$ [$\bar{u}+v,\bar{u},w$]
	(4) \bar{y},\bar{x},\bar{z} [v,u,w]	(5) $\bar{x}+y,y,\bar{z}$ [u-v, \bar{v},w]	(6) $x,x-y,\bar{z}$ [$\bar{u},\bar{u}+v,w$]
	(7) \bar{x},\bar{y},\bar{z} [\bar{u},\bar{v},\bar{w}]	(8) $y,\bar{x}+y,\bar{z}$ [v, $\bar{u}+v,\bar{w}$]	(9) $x-y,x,\bar{z}$ [u-v,u, \bar{w}]
	(10) y,x,z [\bar{v},\bar{u},\bar{w}]	(11) $x-y,\bar{y},z$ [$\bar{u}+v,v,\bar{w}$]	(12) $\bar{x},\bar{x}+y,z$ [u,u-v, \bar{w}]
6 f ..m	$x,0,z$ [u,2u,0]	$0,x,z$ [2 $\bar{u},\bar{u},0$]	\bar{x},\bar{x},z [u, $\bar{u},0$]
	$0,\bar{x},\bar{z}$ [2u,u,0]	$\bar{x},0,\bar{z}$ [$\bar{u},2\bar{u},0$]	x,x,\bar{z} [$\bar{u},u,0$]
6 e ..2'	$x,\bar{x},1/2$ [u,u,w]	$x,2x,1/2$ [$\bar{u},0,w$]	$2\bar{x},\bar{x},1/2$ [0, \bar{u},w]
	$\bar{x},x,1/2$ [\bar{u},\bar{u},\bar{w}]	$\bar{x},2\bar{x},1/2$ [u,0, \bar{w}]	$2x,x,1/2$ [0,u, \bar{w}]
6 d ..2'	$x,\bar{x},0$ [u,u,w]	$x,2x,0$ [$\bar{u},0,w$]	$2\bar{x},\bar{x},0$ [0, \bar{u},w]
	$\bar{x},x,0$ [\bar{u},\bar{u},\bar{w}]	$\bar{x},2\bar{x},0$ [u,0, \bar{w}]	$2x,x,0$ [0,u, \bar{w}]
2 c 3.m	$0,0,z$ [0,0,0]	$0,0,\bar{z}$ [0,0,0]	
1 b $\bar{3}$.m	$0,0,1/2$ [0,0,0]		
1 a $\bar{3}$.m	$0,0,0$ [0,0,0]		

Symmetry of special projections

Along [001] 6mm	Along [100] $p2mm$	Along [210] $p2111'$
Origin at 0,0,z	$a^* = c$ Origin at x,0,0	$a^* = c$ Origin at x,x/2,0

$\rho_{2c} \bar{3}1m'$

$\bar{3}1m1'$

Trigonal

No. 51.6.264

$\rho_{2c} \bar{3}12'/m'$

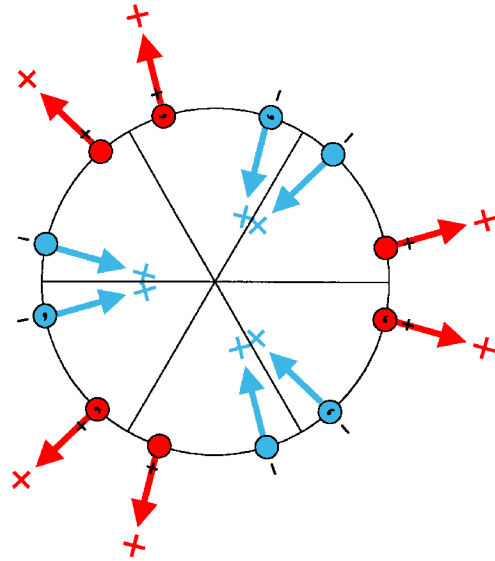
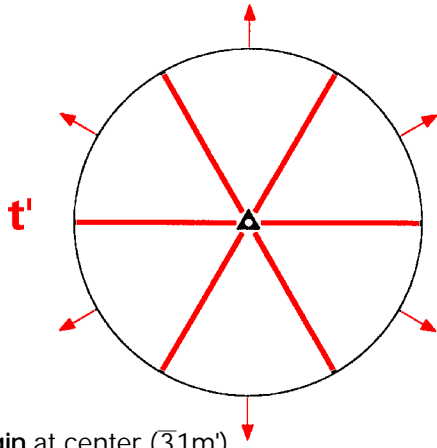

Origin at center ($\bar{3}1m'$)

Asymmetric unit $0 \leq x; 0 \leq y; 0 \leq z \leq 1/2; y \leq x$

Symmetry operations

For (0,0,0) + set

- | | | |
|--|---|--|
| (1) 1
(1 0,0,0) | (2) 3^+ 0,0,z
(3_z 0,0,0) | (3) 3^- 0,0,z
(3_z^{-1} 0,0,0) |
| (4) $2'$ x, \bar{x} ,0
(2_3 0,0,0)' | (5) $2'$ x,2x,0
(2_2 0,0,0)' | (6) $2'$ 2x,x,0
(2_1 0,0,0)' |
| (7) $\bar{1}$ 0,0,0
($\bar{1}$ 0,0,0) | (8) $\bar{3}^+$ 0,0,z; 0,0,0
($\bar{3}_z$ 0,0,0) | (9) $\bar{3}^-$ 0,0,z; 0,0,0
($\bar{3}_z^{-1}$ 0,0,0) |
| (10) m' x,x,z
(m_3 0,0,0)' | (11) m' x,0,z
(m_2 0,0,0)' | (12) m' 0,y,z
(m_1 0,0,0)' |
| For (0,0,1)' + set | | |
| (1) t' (0,0,1)
(1 0,0,1)' | (2) $3^{+'}$ (0,0,1) 0,0,z
(3_z 0,0,1)' | (3) $3^{-'}$ (0,0,1) 0,0,z
(3_z^{-1} 0,0,1)' |
| (4) 2 x, \bar{x} ,1/2
(2_3 0,0,1) | (5) 2 x,2x,1/2
(2_2 0,0,1) | (6) 2 2x,x,1/2
(2_1 0,0,1) |
| (7) $\bar{1}'$ 0,0,1/2
($\bar{1}$ 0,0,1)' | (8) $\bar{3}^{+'}$ 0,0,z; 0,0,1/2
($\bar{3}_z$ 0,0,1)' | (9) $\bar{3}^{-'}$ 0,0,z; 0,0,1/2
($\bar{3}_z^{-1}$ 0,0,1)' |
| (10) c (0,0,1) x,x,z
(m_3 0,0,1) | (11) c (0,0,1) x,0,z
(m_2 0,0,1) | (12) c (0,0,1) 0,y,z
(m_1 0,0,1) |

Generators selected (1); $t(0,0,1)'$; (2); (4); (7)

Positions

Multiplicity, Wyckoff letter, Site symmetry	Coordinates		
		(0,0,0)+	(0,0,1)' +
12 g 1	(1) $x,y,z [u,v,w]$ (4) $\bar{y},\bar{x},\bar{z} [v,u,w]$ (7) $\bar{x},\bar{y},\bar{z} [u,v,w]$ (10) $y,x,z [v,u,w]$	(2) $\bar{y},x-y,z [\bar{v},u-v,w]$ (5) $\bar{x}+y,y,\bar{z} [u-v,\bar{v},w]$ (8) $y,\bar{x}+y,\bar{z} [\bar{v},u-v,w]$ (11) $x-y,\bar{y},z [u-v,\bar{v},w]$	(3) $\bar{x}+y,\bar{x},z [\bar{u}+v,\bar{u},w]$ (6) $x,x-y,\bar{z} [\bar{u},\bar{u}+v,w]$ (9) $x-y,x,\bar{z} [\bar{u}+v,\bar{u},w]$ (12) $\bar{x},\bar{x}+y,z [\bar{u},\bar{u}+v,w]$
6 f ..m'	$x,0,z [u,0,w]$ $0,\bar{x},\bar{z} [0,u,w]$	$0,x,z [0,u,w]$ $\bar{x},0,\bar{z} [u,0,w]$	$\bar{x},\bar{x},z [\bar{u},\bar{u},w]$ $x,x,\bar{z} [\bar{u},\bar{u},w]$
6 e ..2	$x,\bar{x},1/2 [u,\bar{u},0]$ $\bar{x},x,1/2 [\bar{u},u,0]$	$x,2x,1/2 [u,2u,0]$ $\bar{x},2\bar{x},1/2 [\bar{u},2\bar{u},0]$	$2\bar{x},\bar{x},1/2 [2\bar{u},\bar{u},0]$ $2x,x,1/2 [2u,u,0]$
6 d ..2'	$x,\bar{x},0 [u,u,w]$ $\bar{x},x,0 [u,u,w]$	$x,2x,0 [\bar{u},0,w]$ $\bar{x},2\bar{x},0 [\bar{u},0,w]$	$2\bar{x},\bar{x},0 [0,\bar{u},w]$ $2x,x,0 [0,\bar{u},w]$
2 c 3.m'	$0,0,z [0,0,w]$	$0,0,\bar{z} [0,0,w]$	
1 b $\bar{3}'$.m'	$0,0,1/2 [0,0,0]$		
1 a $\bar{3}$.m'	$0,0,0 [0,0,w]$		

Symmetry of special projections

Along [001] $6mm1'$	Along [100] $\rho_{2a^*} 2'mm'$	Along [210] $\rho_{2a^*} 2'11$
Origin at 0,0,z	$a^* = c$ Origin at x,0,0	$a^* = c$ Origin at x,x/2,0

$\rho_{2c} \bar{3}1m$

No. 51.7.265

$\bar{3}1m1'$

$\rho_{2c} \bar{3}12/m$

Trigonal

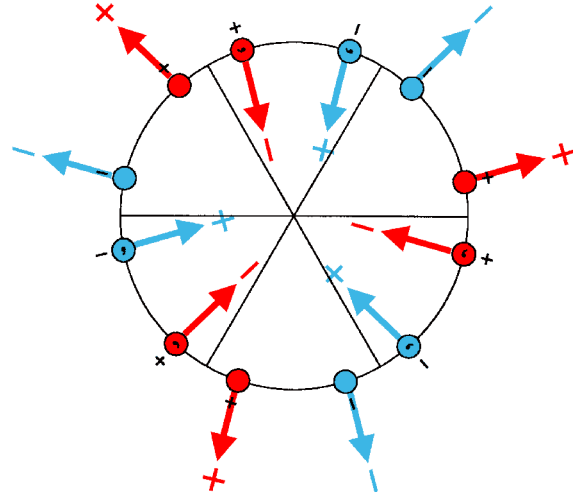
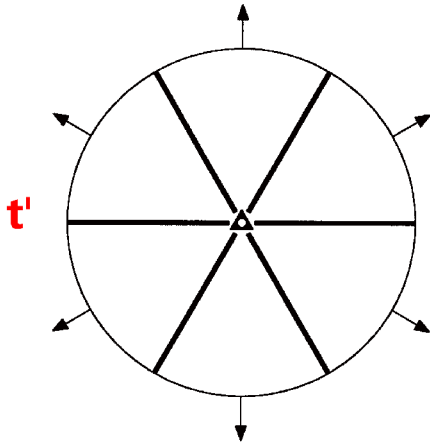

Origin at center ($\bar{3}1m$)

Asymmetric unit $0 \leq x$; $0 \leq y$; $0 \leq z \leq 1/2$; $y \leq x$

Symmetry operations

For (0,0,0) + set

- | | | |
|--|---|--|
| (1) 1
(1 0,0,0) | (2) 3^+ 0,0,z
(3_z 0,0,0) | (3) 3^- 0,0,z
(3_z^{-1} 0,0,0) |
| (4) 2 x, \bar{x} ,0
(2_3 0,0,0) | (5) 2 x,2x,0
(2_2 0,0,0) | (6) 2 2x,x,0
(2_1 0,0,0) |
| (7) $\bar{1}$ 0,0,0
($\bar{1}$ 0,0,0) | (8) $\bar{3}^+$ 0,0,z; 0,0,0
($\bar{3}_z$ 0,0,0) | (9) $\bar{3}^-$ 0,0,z; 0,0,0
($\bar{3}_z^{-1}$ 0,0,0) |
| (10) m x,x,z
(m_3 0,0,0) | (11) m x,0,z
(m_2 0,0,0) | (12) m 0,y,z
(m_1 0,0,0) |

For (0,0,1)' + set

- | | | |
|--|---|--|
| (1) t' (0,0,1)
(1 0,0,1)' | (2) $3^{+'}$ (0,0,1) 0,0,z
(3_z 0,0,1)' | (3) $3^{-'}$ (0,0,1) 0,0,z
(3_z^{-1} 0,0,1)' |
| (4) 2' x, \bar{x} ,1/2
(2_3 0,0,1)' | (5) 2' x,2x,1/2
(2_2 0,0,1)' | (6) 2' 2x,x,1/2
(2_1 0,0,1)' |
| (7) $\bar{1}'$ 0,0,1/2
($\bar{1}$ 0,0,1)' | (8) $\bar{3}^{+'}$ 0,0,z; 0,0,1/2
($\bar{3}_z$ 0,0,1)' | (9) $\bar{3}^{-'}$ 0,0,z; 0,0,1/2
($\bar{3}_z^{-1}$ 0,0,1)' |
| (10) c' (0,0,1) x,x,z
(m_3 0,0,1)' | (11) c' (0,0,1) x,0,z
(m_2 0,0,1)' | (12) c' (0,0,1) 0,y,z
(m_1 0,0,1)' |

Generators selected (1); $t(0,0,1)'$; (2); (4); (7)

Positions

Multiplicity, Wyckoff letter, Site symmetry	Coordinates		
	(0,0,0)+	(0,0,1)'	+
12 g 1	(1) $x,y,z [u,v,w]$ (4) $\bar{y},\bar{x},\bar{z} [\bar{v},\bar{u},\bar{w}]$ (7) $\bar{x},\bar{y},\bar{z} [u,v,w]$ (10) $y,x,z [\bar{v},\bar{u},\bar{w}]$	(2) $\bar{y},x-y,z [\bar{v},u-v,w]$ (5) $\bar{x}+y,y,\bar{z} [\bar{u}+v,v,\bar{w}]$ (8) $y,\bar{x}+y,\bar{z} [\bar{v},u-v,w]$ (11) $x-y,\bar{y},z [\bar{u}+v,v,\bar{w}]$	(3) $\bar{x}+y,\bar{x},z [\bar{u}+v,\bar{u},w]$ (6) $x,x-y,\bar{z} [u,u-v,\bar{w}]$ (9) $x-y,x,\bar{z} [\bar{u}+v,\bar{u},w]$ (12) $\bar{x},\bar{x}+y,z [u,u-v,\bar{w}]$
6 f ..m	$x,0,z [u,2u,0]$ $0,\bar{x},\bar{z} [2\bar{u},\bar{u},0]$	$0,x,z [2\bar{u},\bar{u},0]$ $\bar{x},0,\bar{z} [u,2u,0]$	$\bar{x},\bar{x},z [u,\bar{u},0]$ $x,x,\bar{z} [u,\bar{u},0]$
6 e ..2'	$x,\bar{x},1/2 [u,u,w]$ $\bar{x},x,1/2 [\bar{u},\bar{u},\bar{w}]$	$x,2x,1/2 [\bar{u},0,w]$ $\bar{x},2\bar{x},1/2 [u,0,\bar{w}]$	$2\bar{x},\bar{x},1/2 [0,\bar{u},w]$ $2x,x,1/2 [0,u,\bar{w}]$
6 d ..2	$x,\bar{x},0 [u,\bar{u},0]$ $\bar{x},x,0 [u,\bar{u},0]$	$x,2x,0 [u,2u,0]$ $\bar{x},2\bar{x},0 [u,2u,0]$	$2\bar{x},\bar{x},0 [2\bar{u},\bar{u},0]$ $2x,x,0 [2\bar{u},\bar{u},0]$
2 c 3.m	$0,0,z [0,0,0]$	$0,0,\bar{z} [0,0,0]$	
1 b $\bar{3}'$.m	$0,0,1/2 [0,0,0]$		
1 a $\bar{3}$.m	$0,0,0 [0,0,0]$		

Symmetry of special projections

Along [001] $6mm1'$	Along [100] $\rho_{2a^*} 2'm'm$	Along [210] ρ_{2111}'
Origin at 0,0,z	$a^* = c$ Origin at x,0,0	$a^* = c$ Origin at x,x/2,0

$p\bar{3}1c$

No. 52.1.266

$\bar{3}1m$

$p\bar{3}12/c$

Trigonal

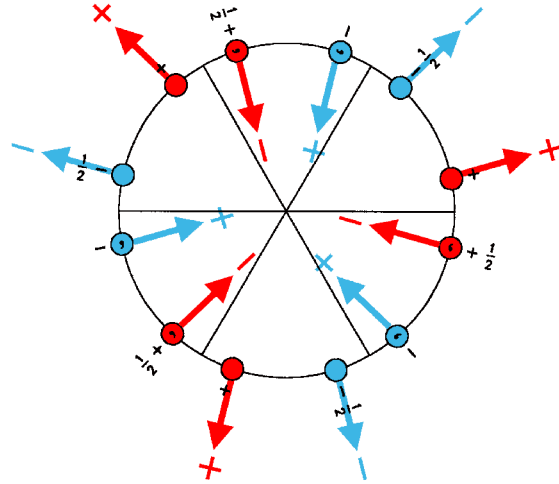
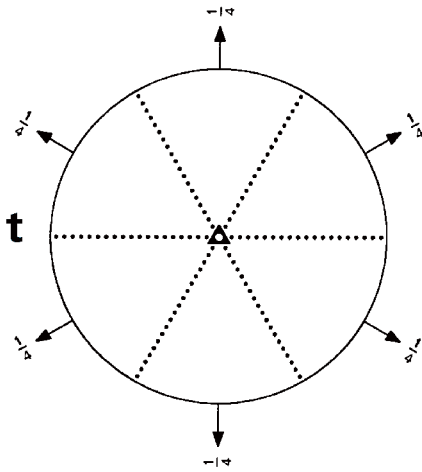

Origin at center ($\bar{3}$) at $\bar{3}1c$

Asymmetric unit $0 \leq x; 0 \leq y; 0 \leq z \leq 1/4$

Symmetry operations

- | | | |
|--|---|--|
| (1) 1
(1 0,0,0) | (2) 3^+ 0,0,z
(3_z 0,0,0) | (3) 3^- 0,0,z
(3_z^{-1} 0,0,0) |
| (4) 2 x, \bar{x} ,1/4
(2_3 0,0,1/2) | (5) 2 x,2x,1/4
(2_2 0,0,1/2) | (6) 2 2x,x,1/4
(2_1 0,0,1/2) |
| (7) $\bar{1}$ 0,0,0
($\bar{1}$ 0,0,0) | (8) $\bar{3}^+$ 0,0,z; 0,0,0
($\bar{3}_z$ 0,0,0) | (9) $\bar{3}^-$ 0,0,z; 0,0,0
($\bar{3}_z^{-1}$ 0,0,0) |
| (10) c (0,0,1/2) x,x,z
(m_3 0,0,1/2) | (11) c (0,0,1/2) x,0,z
(m_2 0,0,1/2) | (12) c (0,0,1/2) 0,y,z
(m_1 0,0,1/2) |

Generators selected (1); $t(0,0,1)$; (2); (4); (7)

Positions

Multiplicity, Wyckoff letter, Site symmetry	Coordinates			
12 e 1	(1) x,y,z [u,v,w]	(2) $\bar{y},x-y,z$ [$\bar{v},u-v,w$]	(3) $\bar{x}+y,\bar{x},z$ [$\bar{u}+v,\bar{u},w$]	
	(4) $\bar{y},\bar{x},\bar{z}+1/2$ [\bar{v},\bar{u},\bar{w}]	(5) $\bar{x}+y,y,\bar{z}+1/2$ [$\bar{u}+v,v,\bar{w}$]	(6) $x,x-y,\bar{z}+1/2$ [$u,u-v,\bar{w}$]	
	(7) \bar{x},\bar{y},\bar{z} [u,v,w]	(8) $y,\bar{x}+y,\bar{z}$ [$\bar{v},u-v,w$]	(9) $x-y,x,\bar{z}$ [$\bar{u}+v,\bar{u},w$]	
	(10) $y,x,z+1/2$ [\bar{v},\bar{u},\bar{w}]	(11) $x-y,\bar{y},z+1/2$ [$\bar{u}+v,v,\bar{w}$]	(12) $\bar{x},\bar{x}+y,z+1/2$ [$u,u-v,\bar{w}$]	
6 d ..2	$x,\bar{x},1/4$ [$u,\bar{u},0$]	$x,2x,1/4$ [$u,2u,0$]	$2\bar{x},\bar{x},1/4$ [$2\bar{u},\bar{u},0$]	
	$\bar{x},x,3/4$ [$u,\bar{u},0$]	$\bar{x},2\bar{x},3/4$ [$u,2u,0$]	$2x,x,3/4$ [$2\bar{u},\bar{u},0$]	
4 c 3..	$0,0,z$ [$0,0,w$]	$0,0,\bar{z}+1/2$ [$0,0,\bar{w}$]	$0,0,\bar{z}$ [$0,0,w$]	$0,0,z+1/2$ [$0,0,\bar{w}$]
2 b $\bar{3}$..	$0,0,0$ [$0,0,w$]	$0,0,1/2$ [$0,0,\bar{w}$]		
1 a 3.2	$0,0,1/4$ [$0,0,0$]	$0,0,3/4$ [$0,0,0$]		

Symmetry of special projections

Along [001] $6'm'm$	Along [100] $\rho 2'm'g$	Along [210] $\rho_{2a^*} 2'11$
Origin at $0,0,z$	$a^* = c$ Origin at $x,0,0$	$a^* = c/2$ Origin at $x,x/2,0$

$p\bar{3}1c1'$

$\bar{3}1m1'$

Trigonal

No. 52.2.267

$p\bar{3}12/c1'$

1'

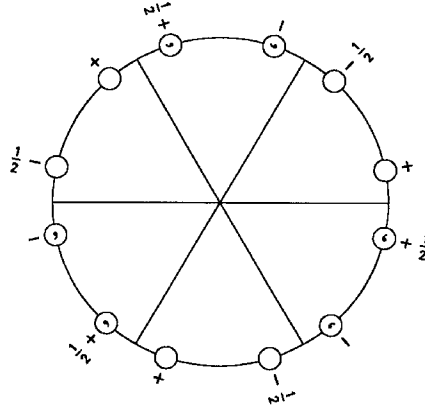
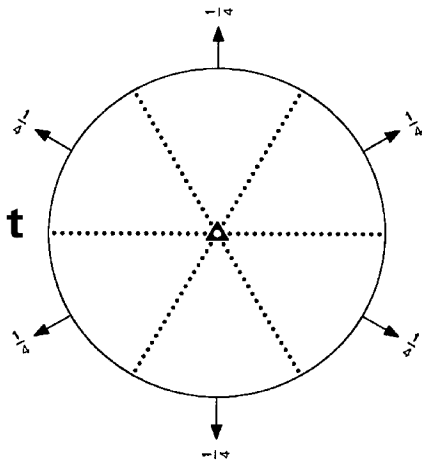

Origin at center ($\bar{3}1'$) at $\bar{3}1c1'$

Asymmetric unit $0 \leq x; 0 \leq y; 0 \leq z \leq 1/4$

Symmetry operations

For 1 + set

- | | | |
|--|---|--|
| (1) 1
(1 0,0,0) | (2) 3^+ 0,0,z
(3_z 0,0,0) | (3) 3^- 0,0,z
(3_z^{-1} 0,0,0) |
| (4) 2 x, \bar{x} ,1/4
(2_3 0,0,1/2) | (5) 2 x,2x,1/4
(2_2 0,0,1/2) | (6) 2 2x,x,1/4
(2_1 0,0,1/2) |
| (7) $\bar{1}$ 0,0,0
($\bar{1}$ 0,0,0) | (8) $\bar{3}^+$ 0,0,z; 0,0,0
($\bar{3}_z$ 0,0,0) | (9) $\bar{3}^-$ 0,0,z; 0,0,0
($\bar{3}_z^{-1}$ 0,0,0) |
| (10) c (0,0,1/2) x,x,z
(m_3 0,0,1/2) | (11) c (0,0,1/2) x,0,z
(m_2 0,0,1/2) | (12) c (0,0,1/2) 0,y,z
(m_1 0,0,1/2) |

For 1' + set

- | | | |
|--|---|--|
| (1) 1'
(1 0,0,0)' | (2) $3^{+'}$ 0,0,z
(3_z 0,0,0)' | (3) $3^{-'}$ 0,0,z
(3_z^{-1} 0,0,0)' |
| (4) 2' x, \bar{x} ,1/4
(2_3 0,0,1/2)' | (5) 2' x,2x,1/4
(2_2 0,0,1/2)' | (6) 2' 2x,x,1/4
(2_1 0,0,1/2)' |
| (7) $\bar{1}'$ 0,0,0
($\bar{1}$ 0,0,0)' | (8) $\bar{3}^{+'}$ 0,0,z; 0,0,0
($\bar{3}_z$ 0,0,0)' | (9) $\bar{3}^{-'}$ 0,0,z; 0,0,0
($\bar{3}_z^{-1}$ 0,0,0)' |
| (10) c' (0,0,1/2) x,x,z
(m_3 0,0,1/2)' | (11) c' (0,0,1/2) x,0,z
(m_2 0,0,1/2)' | (12) c' (0,0,1/2) 0,y,z
(m_1 0,0,1/2)' |

Generators selected (1); $t(0,0,1)$; (2); (4); (7); $1'$

Positions

Multiplicity, Wyckoff letter, Site symmetry	Coordinates			
		1+	1'+	
12 e $11'$	(1) x,y,z [0,0,0] (4) $\bar{y},\bar{x},\bar{z}+1/2$ [0,0,0] (7) \bar{x},\bar{y},\bar{z} [0,0,0] (10) $y,x,z+1/2$ [0,0,0]	(2) $\bar{y},x-y,z$ [0,0,0] (5) $\bar{x}+y,y,\bar{z}+1/2$ [0,0,0] (8) $y,\bar{x}+y,\bar{z}$ [0,0,0] (11) $x-y,\bar{y},z+1/2$ [0,0,0]	(3) $\bar{x}+y,\bar{x},z$ [0,0,0] (6) $x,x-y,\bar{z}+1/2$ [0,0,0] (9) $x-y,x,\bar{z}$ [0,0,0] (12) $\bar{x},\bar{x}+y,z+1/2$ [0,0,0]	
6 d $..21'$	$x,\bar{x},1/4$ [0,0,0] $\bar{x},x,3/4$ [0,0,0]	$x,2x,1/4$ [0,0,0] $\bar{x},2\bar{x},3/4$ [0,0,0]	$2\bar{x},\bar{x},1/4$ [0,0,0] $2x,x,3/4$ [0,0,0]	
4 c $3..1'$	$0,0,z$ [0,0,0]	$0,0,\bar{z}+1/2$ [0,0,0]	$0,0,\bar{z}$ [0,0,0]	$0,0,z+1/2$ [0,0,0]
2 b $\bar{3}..1'$	$0,0,0$ [0,0,0]		$0,0,1/2$ [0,0,0]	
1 a $3.21'$	$0,0,1/4$ [0,0,0]		$0,0,3/4$ [0,0,0]	

Symmetry of special projections

Along [001] $6mm1'$	Along [100] $p2mg1'$	Along [210] $p2111'$
Origin at 0,0,z	$a^* = c$ Origin at x,0,0	$a^* = c/2$ Origin at x,x/2,0

$p\bar{3}'1c'$

No. 52.3.268

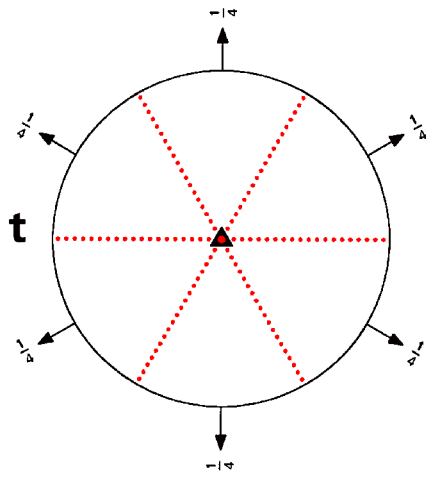

$\bar{3}'1m'$

$p\bar{3}'12/c'$

Trigonal

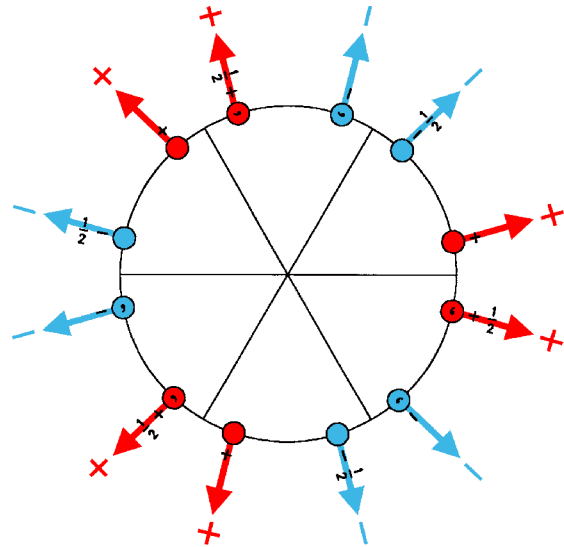

Origin at center ($\bar{3}'$) at $\bar{3}'1c'$

Asymmetric unit $0 \leq x$; $0 \leq y$; $0 \leq z \leq 1/4$

Symmetry operations

- | | | |
|---|--|---|
| (1) 1
(1 0,0,0) | (2) 3^+ 0,0,z
(3_z 0,0,0) | (3) 3^- 0,0,z
(3_z^{-1} 0,0,0) |
| (4) 2 x, \bar{x} ,1/4
(2_3 0,0,1/2) | (5) 2 x,2x,1/4
(2_2 0,0,1/2) | (6) 2 2x,x,1/4
(2_1 0,0,1/2) |
| (7) $\bar{1}$ 0,0,0
($\bar{1}$ 0,0,0)' | (8) $\bar{3}^+$ 0,0,z; 0,0,0
($\bar{3}_z$ 0,0,0)' | (9) $\bar{3}^-$ 0,0,z; 0,0,0
($\bar{3}_z^{-1}$ 0,0,0)' |
| (10) c' (0,0,1/2) x,x,z
(m_3 0,0,1/2)' | (11) c' (0,0,1/2) x,0,z
(m_2 0,0,1/2)' | (12) c' (0,0,1/2) 0,y,z
(m_1 0,0,1/2)' |

Generators selected (1); $t(0,0,1)$; (2); (4); (7)

Positions

Multiplicity, Wyckoff letter, Site symmetry	Coordinates			
12 e 1	(1) x,y,z [u,v,w]	(2) $\bar{y},x-y,z$ [$\bar{v},u-v,w$]	(3) $\bar{x}+y,\bar{x},z$ [$\bar{u}+v,\bar{u},w$]	
	(4) $\bar{y},\bar{x},\bar{z}+1/2$ [\bar{v},\bar{u},\bar{w}]	(5) $\bar{x}+y,y,\bar{z}+1/2$ [$\bar{u}+v,v,\bar{w}$]	(6) $x,x-y,\bar{z}+1/2$ [$u,u-v,\bar{w}$]	
	(7) \bar{x},\bar{y},\bar{z} [\bar{u},\bar{v},\bar{w}]	(8) $y,\bar{x}+y,\bar{z}$ [$v,\bar{u}+v,\bar{w}$]	(9) $x-y,x,\bar{z}$ [$u-v,u,\bar{w}$]	
	(10) $y,x,z+1/2$ [v,u,w]	(11) $x-y,\bar{y},z+1/2$ [$u-v,\bar{v},w$]	(12) $\bar{x},\bar{x}+y,z+1/2$ [$\bar{u},\bar{u}+v,w$]	
6 d ..2	$x,\bar{x},1/4$ [$u,\bar{u},0$]	$x,2x,1/4$ [$u,2u,0$]	$2\bar{x},\bar{x},1/4$ [$2\bar{u},\bar{u},0$]	
	$\bar{x},x,3/4$ [$\bar{u},u,0$]	$\bar{x},2\bar{x},3/4$ [$\bar{u},2\bar{u},0$]	$2x,x,3/4$ [$2u,u,0$]	
4 c 3..	$0,0,z$ [$0,0,w$]	$0,0,\bar{z}+1/2$ [$0,0,\bar{w}$]	$0,0,\bar{z}$ [$0,0,\bar{w}$]	$0,0,z+1/2$ [$0,0,w$]
2 b $\bar{3}'..$	$0,0,0$ [$0,0,0$]	$0,0,1/2$ [$0,0,0$]		
1 a 3.2	$0,0,1/4$ [$0,0,0$]	$0,0,3/4$ [$0,0,0$]		

Symmetry of special projections

Along [001] $6m'm'$ Origin at $0,0,z$ Along [100] $p2m'g'$ $a^* = c$ Origin at $x,0,0$ Along [210] $p211$ $a^* = c/2$ Origin at $x,x/2,0$

$p\bar{3}1c'$

No. 52.4.269

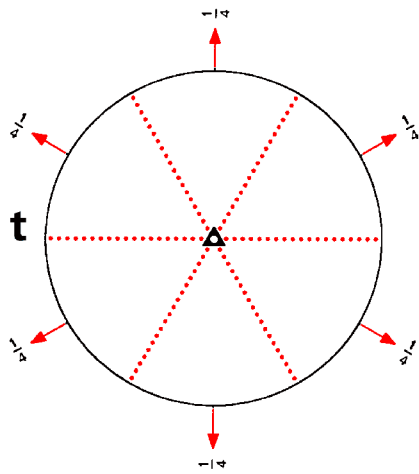

$\bar{3}1m'$

$p\bar{3}12'/c'$

Trigonal

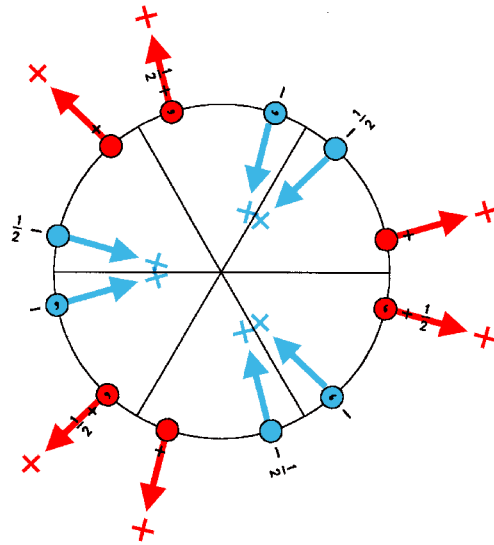

Origin at center ($\bar{3}$) at $\bar{3}1c'$

Asymmetric unit $0 \leq x$; $0 \leq y$; $0 \leq z \leq 1/4$

Symmetry operations

- | | | |
|--|---|--|
| (1) 1
(1 0,0,0) | (2) 3^+ 0,0,z
(3_z 0,0,0) | (3) 3^- 0,0,z
(3_z^{-1} 0,0,0) |
| (4) $2'$ x, \bar{x} ,1/4
(2_3 0,0,1/2)' | (5) $2'$ x,2x,1/4
(2_2 0,0,1/2)' | (6) $2'$ 2x,x,1/4
(2_1 0,0,1/2)' |
| (7) $\bar{1}$ 0,0,0
($\bar{1}$ 0,0,0) | (8) $\bar{3}^+$ 0,0,z; 0,0,0
($\bar{3}_z$ 0,0,0) | (9) $\bar{3}^-$ 0,0,z; 0,0,0
($\bar{3}_z^{-1}$ 0,0,0) |
| (10) c' (0,0,1/2) x,x,z
(m_3 0,0,1/2)' | (11) c' (0,0,1/2) x,0,z
(m_2 0,0,1/2)' | (12) c' (0,0,1/2) 0,y,z
(m_1 0,0,1/2)' |

Generators selected (1); $t(0,0,1)$; (2); (4); (7)

Positions

Multiplicity, Wyckoff letter, Site symmetry	Coordinates			
12 e 1	(1) x,y,z [u,v,w]	(2) $\bar{y},x-y,z$ [\bar{v} ,u-v,w]	(3) $\bar{x}+y,\bar{x},z$ [$\bar{u}+v,\bar{u}$,w]	
	(4) $\bar{y},\bar{x},\bar{z}+1/2$ [v,u,w]	(5) $\bar{x}+y,y,\bar{z}+1/2$ [u-v, \bar{v} ,w]	(6) $x,x-y,\bar{z}+1/2$ [$\bar{u},\bar{u}+v$,w]	
	(7) \bar{x},\bar{y},\bar{z} [u,v,w]	(8) $y,\bar{x}+y,\bar{z}$ [\bar{v} ,u-v,w]	(9) $x-y,x,\bar{z}$ [$\bar{u}+v,\bar{u}$,w]	
	(10) $y,x,z+1/2$ [v,u,w]	(11) $x-y,\bar{y},z+1/2$ [u-v, \bar{v} ,w]	(12) $\bar{x},\bar{x}+y,z+1/2$ [$\bar{u},\bar{u}+v$,w]	
6 d ..2'	$x,\bar{x},1/4$ [u,u,w]	$x,2x,1/4$ [$\bar{u},0,w$]	$2\bar{x},\bar{x},1/4$ [0, \bar{u} ,w]	
	$\bar{x},x,3/4$ [u,u,w]	$\bar{x},2\bar{x},3/4$ [$\bar{u},0,w$]	$2x,x,3/4$ [0, \bar{u} ,w]	
4 c 3..	$0,0,z$ [0,0,w]	$0,0,\bar{z}+1/2$ [0,0,w]	$0,0,\bar{z}$ [0,0,w]	$0,0,z+1/2$ [0,0,w]
2 b $\bar{3}..$	$0,0,0$ [0,0,w]	$0,0,1/2$ [0,0,w]		
1 a 3.2'	$0,0,1/4$ [0,0,w]	$0,0,3/4$ [0,0,w]		

Symmetry of special projections

Along [001] $6'mm'$	Along [100] $p2'mg'$	Along [210] $p2'11$
Origin at 0,0,z	$a^* = c$ Origin at x,0,0	$a^* = c/2$ Origin at x,x/2,0

$p\bar{3}1c$

No. 52.5.270

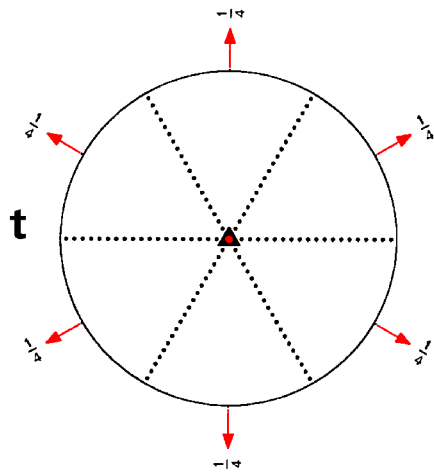

$\bar{3}1m$

$p\bar{3}12'/c$

Trigonal

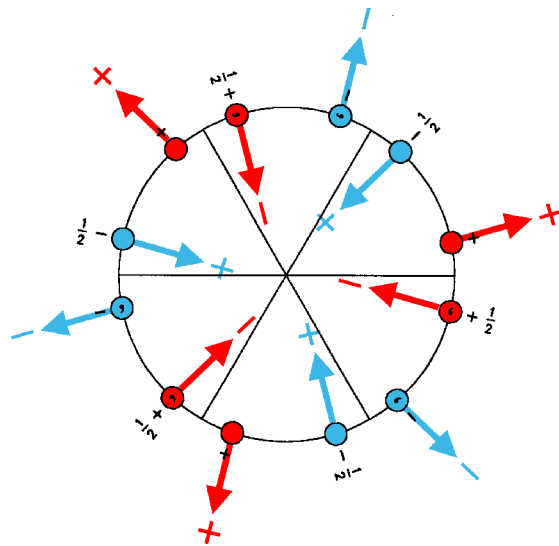

Origin at center ($\bar{3}$) at $\bar{3}1c'$

Asymmetric unit $0 \leq x$; $0 \leq y$; $0 \leq z \leq 1/4$

Symmetry operations

- | | | |
|--|--|---|
| (1) 1
(1 0,0,0) | (2) 3^+ 0,0,z
(3_z 0,0,0) | (3) 3^- 0,0,z
(3_z^{-1} 0,0,0) |
| (4) $2'$ x, \bar{x} ,1/4
(2_3 0,0,1/2)' | (5) $2'$ x,2x,1/4
(2_2 0,0,1/2)' | (6) $2'$ 2x,x,1/4
(2_1 0,0,1/2)' |
| (7) $\bar{1}'$ 0,0,0
($\bar{1}$ 0,0,0)' | (8) $\bar{3}^+$ 0,0,z; 0,0,0
($\bar{3}_z$ 0,0,0)' | (9) $\bar{3}^-$ 0,0,z; 0,0,0
($\bar{3}_z^{-1}$ 0,0,0)' |
| (10) c (0,0,1/2) x,x,z
(m_3 0,0,1/2) | (11) c (0,0,1/2) x,0,z
(m_2 0,0,1/2) | (12) c (0,0,1/2) 0,y,z
(m_1 0,0,1/2) |

Generators selected (1); $t(0,0,1)$; (2); (4); (7)

Positions

Multiplicity, Wyckoff letter, Site symmetry	Coordinates			
12 e 1	(1) x,y,z [u,v,w]	(2) $\bar{y},x-y,z$ [$\bar{v},u-v,w$]	(3) $\bar{x}+y,\bar{x},z$ [$\bar{u}+v,\bar{u},w$]	
	(4) $\bar{y},\bar{x},\bar{z}+1/2$ [v,u,w]	(5) $\bar{x}+y,y,\bar{z}+1/2$ [$u-v,\bar{v},w$]	(6) $x,x-y,\bar{z}+1/2$ [$\bar{u},\bar{u}+v,w$]	
	(7) \bar{x},\bar{y},\bar{z} [\bar{u},\bar{v},\bar{w}]	(8) $y,\bar{x}+y,\bar{z}$ [$v,\bar{u}+v,\bar{w}$]	(9) $x-y,x,\bar{z}$ [$u-v,u,\bar{w}$]	
	(10) $y,x,z+1/2$ [\bar{v},\bar{u},\bar{w}]	(11) $x-y,\bar{y},z+1/2$ [$\bar{u}+v,v,\bar{w}$]	(12) $\bar{x},\bar{x}+y,z+1/2$ [$u,u-v,\bar{w}$]	
6 d ..2'	$x,\bar{x},1/4$ [u,u,w]	$x,2x,1/4$ [$\bar{u},0,w$]	$2\bar{x},\bar{x},1/4$ [$0,\bar{u},w$]	
	$\bar{x},x,3/4$ [\bar{u},\bar{u},\bar{w}]	$\bar{x},2\bar{x},3/4$ [$u,0,\bar{w}$]	$2x,x,3/4$ [$0,u,\bar{w}$]	
4 c 3..	$0,0,z$ [$0,0,w$]	$0,0,\bar{z}+1/2$ [$0,0,w$]	$0,0,\bar{z}$ [$0,0,\bar{w}$]	$0,0,z+1/2$ [$0,0,\bar{w}$]
2 b $\bar{3}'..$	$0,0,0$ [$0,0,0$]	$0,0,1/2$ [$0,0,0$]		
1 a 3.2'	$0,0,1/4$ [$0,0,w$]	$0,0,3/4$ [$0,0,\bar{w}$]		

Symmetry of special projections

Along [001] $6mm$	Along [100] $p2mg$ $a^* = c$	Along [210] $p_{2a^*}211$ $a^* = c/2$
Origin at $0,0,z$	Origin at $x,0,0$	Origin at $x,x/2,0$

$p6$

6

Hexagonal

No. 53.1.271

$p6$

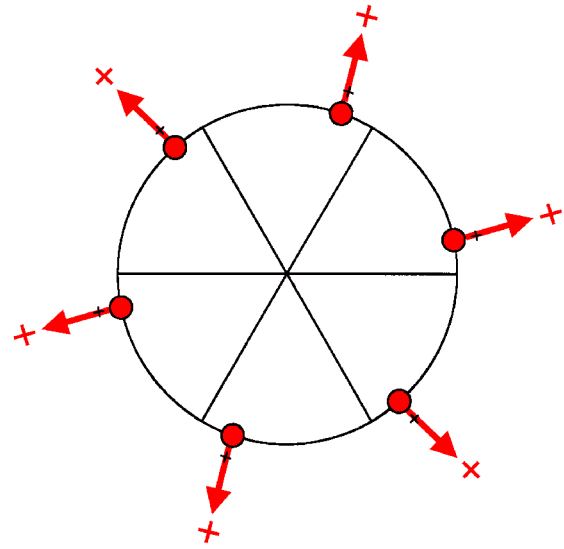
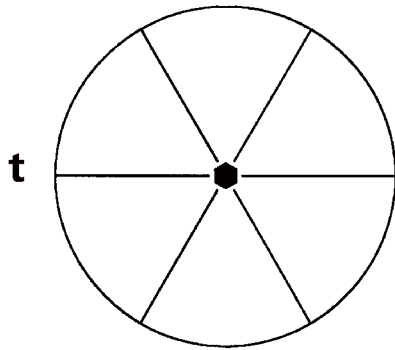

Origin on 6

Asymmetric unit $0 \leq x; 0 \leq y; 0 \leq z \leq 1; y \leq x$

Symmetry operations

(1) 1
(1|0,0,0)

(2) 3^+ 0,0,z
(3_z |0,0,0)

(3) 3^- 0,0,z
(3_z^{-1} |0,0,0)

(4) 2 0,0,z
(2_z |0,0,0)

(5) 6^- 0,0,z
(6_z^{-1} |0,0,0)

(6) 6^+ 0,0,z
(6_z |0,0,0)

Generators selected (1); $t(0,0,1)$; (2); (4)

Positions

Multiplicity, Wyckoff letter, Site symmetry	Coordinates			
	(1) x,y,z [u,v,w]	(2) $\bar{y},x-y,z$ [$\bar{v},u-v,w$]	(3) $\bar{x}+y,\bar{x},z$ [$\bar{u}+v,\bar{u},w$]	(4) \bar{x},\bar{y},z [\bar{u},\bar{v},w]
6 b 1	(1) x,y,z [u,v,w]	(2) $\bar{y},x-y,z$ [$\bar{v},u-v,w$]	(3) $\bar{x}+y,\bar{x},z$ [$\bar{u}+v,\bar{u},w$]	(4) \bar{x},\bar{y},z [\bar{u},\bar{v},w]
		(5) $y,\bar{x}+y,z$ [$v,\bar{u}+v,w$]	(6) $x-y,x,z$ [$u-v,u,w$]	
1 a 6	0,0,z [0,0,w]			

Symmetry of special projections

Along [001] 6	Along [100] $p11m'$ $a^* = c$	Along [210] $p11m'$ $a^* = c$
Origin at 0,0,z	Origin at x,0,0	Origin at x,x/2,0

$p61'$

$61'$

Hexagonal

No. 53.2.272

$p61'$

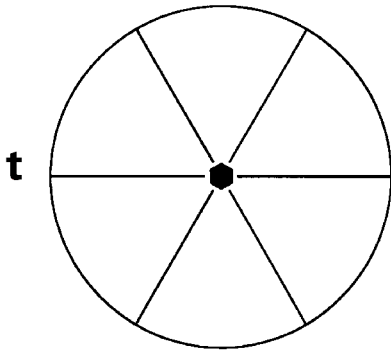

1'

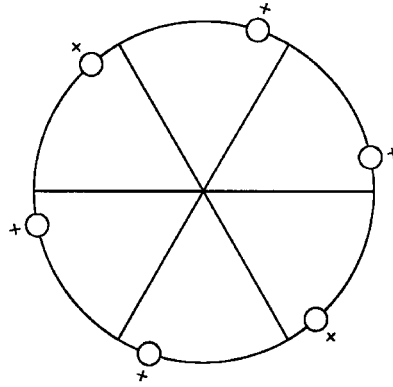

Origin on $61'$

Asymmetric unit $0 \leq x; 0 \leq y; 0 \leq z \leq 1; y \leq x$

Symmetry operations

For $1 +$ set

(1) 1
 $(1|0,0,0)$

(2) 3^+ $0,0,z$
 $(3_z|0,0,0)$

(3) 3^- $0,0,z$
 $(3_z^{-1}|0,0,0)$

(4) 2 $0,0,z$
 $(2_z|0,0,0)$

(5) 6^- $0,0,z$
 $(6_z^{-1}|0,0,0)$

(6) 6^+ $0,0,z$
 $(6_z|0,0,0)$

For $1' +$ set

(1) $1'$
 $(1|0,0,0)'$

(2) $3^{+'}$ $0,0,z$
 $(3_z|0,0,0)'$

(3) $3^{-'}$ $0,0,z$
 $(3_z^{-1}|0,0,0)'$

(4) $2'$ $0,0,z$
 $(2_z|0,0,0)'$

(5) $6^{-'}$ $0,0,z$
 $(6_z^{-1}|0,0,0)'$

(6) $6^{+'}$ $0,0,z$
 $(6_z|0,0,0)'$

Continued

No. 53.2.272

$p61'$

Generators selected (1); $t(0,0,1)$; (2); (4); $1'$

Positions

Multiplicity, Wyckoff letter, Site symmetry	Coordinates		
	$1+$	$1'+$	
6 b $11'$	(1) x,y,z [0,0,0]	(2) $\bar{y},x-y,z$ [0,0,0]	(3) $\bar{x}+y,\bar{x},z$ [0,0,0]
	(4) \bar{x},\bar{y},z [0,0,0]	(5) $y,\bar{x}+y,z$ [0,0,0]	(6) $x-y,x,z$ [0,0,0]
1 a $61'$	0,0,z [0,0,0]		

Symmetry of special projections

Along [001] $61'$	Along [100] $p11m1'$	Along [210] $p11m1'$
Origin at 0,0,z	$a^* = c$ Origin at $x,0,0$	$a^* = c$ Origin at $x,x/2,0$

$p6'$

No. 53.3.273

$6'$

$p6'$

Hexagonal

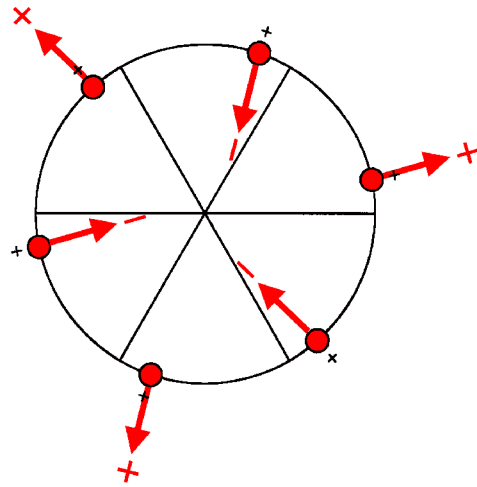
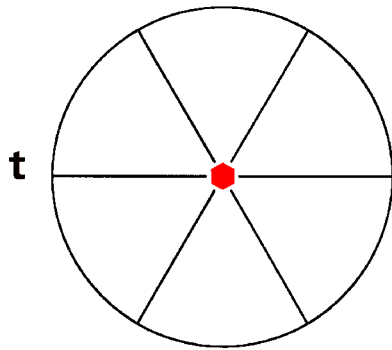

Origin on $6'$

Asymmetric unit $0 \leq x; 0 \leq y; 0 \leq z \leq 1; y \leq x$

Symmetry operations

$$(1) 1 \\ (1|0,0,0)$$

$$(2) 3^+ 0,0,z \\ (3_z|0,0,0)$$

$$(3) 3^- 0,0,z \\ (3_z^{-1}|0,0,0)$$

$$(4) 2' 0,0,z \\ (2_z|0,0,0)'$$

$$(5) 6^- 0,0,z \\ (6_z^{-1}|0,0,0)'$$

$$(6) 6^+ 0,0,z \\ (6_z|0,0,0)'$$

Continued

No. 53.3.273

$p6'$

Generators selected (1); $t(0,0,1)$; (2); (4)

Positions

	Coordinates		
Multiplicity, Wyckoff letter, Site symmetry			
6 b 1	(1) x,y,z [u,v,w]	(2) $\bar{y},x-y,z$ [$\bar{v},u-v,w$]	(3) $\bar{x}+y,\bar{x},z$ [$\bar{u}+v,\bar{u},w$]
	(4) \bar{x},\bar{y},z [u,v,\bar{w}]	(5) $y,\bar{x}+y,z$ [$\bar{v},u-v,\bar{w}$]	(6) $x-y,x,z$ [$\bar{u}+v,\bar{u},\bar{w}$]
1 a $6'$	0,0,z [0,0,0]		

Symmetry of special projections

Along [001] $6'$	Along [100] $p11m$ $a^* = c$	Along [210] $p11m$ $a^* = c$
Origin at 0,0,z	Origin at x,0,0	Origin at x,x/2,0

$p_{2c}6'$

$61'$

Hexagonal

No. 53.4.274

$p_{2c}6'$

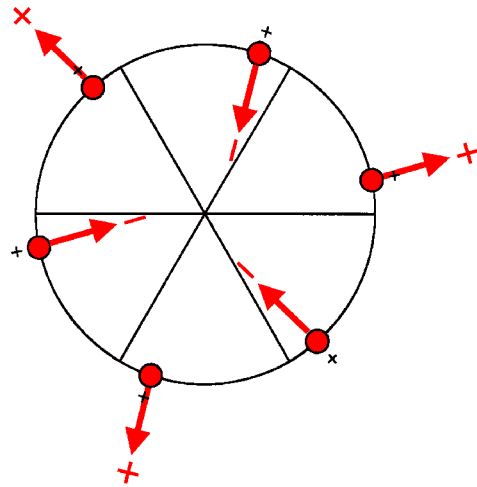
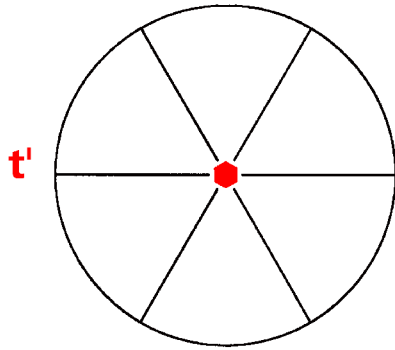

Origin on $6'$

Asymmetric unit $0 \leq x; 0 \leq y; 0 \leq z \leq 1; y \leq x$

Symmetry operations

For $(0,0,0)$ + set

- | | | |
|------------------------------------|---------------------------------------|---|
| (1) 1
(1 0,0,0) | (2) 3^+ 0,0,z
(3_z 0,0,0) | (3) 3^- 0,0,z
(3_z^{-1} 0,0,0) |
| (4) $2'$ 0,0,z
(2_z 0,0,0)' | (5) 6^+ 0,0,z
(6_z^+ 0,0,0)' | (6) 6^+ 0,0,z
(6_z 0,0,0)' |

For $(0,0,1)$ + set

- | | | |
|--|---|--|
| (1) t' (0,0,1)
(1 0,0,1)' | (2) $3^{+ '}$ (0,0,1) 0,0,z
(3_z 0,0,1)' | (3) $3^{- '}$ (0,0,1) 0,0,z
(3_z^{-1} 0,0,1)' |
| (4) 2 (0,0,1) 0,0,z
(2_z 0,0,1) | (5) 6^+ (0,0,1) 0,0,z
(6_z^+ 0,0,1) | (6) 6^+ (0,0,1) 0,0,z
(6_z 0,0,1) |

Continued

No. 53.4.274

 $\rho_{2c} 6'$ Generators selected (1); $t(0,0,1)'$; (2); (4)

Positions

		Coordinates		
Multiplicity, Wyckoff letter, Site symmetry		(0,0,0)+	(0,0,1)' +	
6	b 1	(1) $x,y,z [u,v,w]$	(2) $\bar{y},x-y,z [\bar{v},u-v,w]$	(3) $\bar{x}+y,\bar{x},z [\bar{u}+v,\bar{u},w]$
		(4) $\bar{x},\bar{y},z [u,v,\bar{w}]$	(5) $y,\bar{x}+y,z [\bar{v},u-v,\bar{w}]$	(6) $x-y,x,z [\bar{u}+v,\bar{u},\bar{w}]$
1	a 6'	0,0,z [0,0,0]		

Symmetry of special projections

Along [001] $61'$	Along [100] $\rho_{2a^*} 11m$ $a^* = c$	Along [210] $\rho_{2a^*} 11m$ $a^* = c$
Origin at 0,0,z	Origin at x,0,0	Origin at x,x/2,0

$p_{2c}6$

$61'$

Hexagonal

No. 53.5.275

$p_{2c}6$

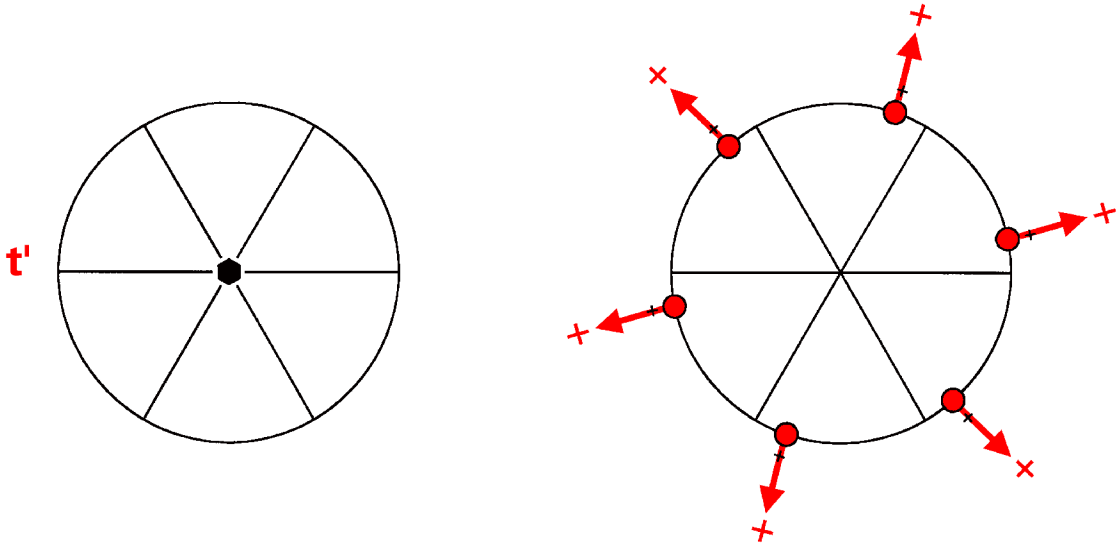

Origin on 6

Asymmetric unit $0 \leq x; 0 \leq y; 0 \leq z \leq 1; y \leq x$

Symmetry operations

For $(0,0,0)$ + set

- | | | |
|--------------------------------|---|---|
| (1) 1
(1 0,0,0) | (2) 3^+ 0,0,z
(3_z 0,0,0) | (3) 3^- 0,0,z
(3_z^{-1} 0,0,0) |
| (4) 2 0,0,z
(2_z 0,0,0) | (5) 6^- 0,0,z
(6_z^{-1} 0,0,0) | (6) 6^+ 0,0,z
(6_z 0,0,0) |

For $(0,0,1)'$ + set

- | | | |
|--|---|---|
| (1) t' (0,0,1)
(1 0,0,1)' | (2) $3^{+'}$ (0,0,1) 0,0,z
(3_z 0,0,1)' | (3) $3^{-'}$ (0,0,1) 0,0,z
(3_z^{-1} 0,0,1)' |
| (4) $2'$ (0,0,1) 0,0,z
(2_z 0,0,1)' | (5) $6^{-'}$ (0,0,1) 0,0,z
(6_z^{-1} 0,0,1)' | (6) $6^{+'}$ (0,0,1) 0,0,z
(6_z 0,0,1)' |

Generators selected (1); $t(0,0,1)'$; (2); (4)

Positions

		Coordinates		
Multiplicity, Wyckoff letter, Site symmetry		(0,0,0)+	(0,0,1)' +	
6	b 1	(1) $x,y,z [u,v,w]$	(2) $\bar{y},x-y,z [\bar{v},u-v,w]$	(3) $\bar{x}+y,\bar{x},z [\bar{u}+v,\bar{u},w]$
		(4) $\bar{x},\bar{y},z [\bar{u},\bar{v},w]$	(5) $y,\bar{x}+y,z [v,\bar{u}+v,w]$	(6) $x-y,x,z [u-v,u,w]$
1	a 6	0,0,z [0,0,w]		

Symmetry of special projections

Along [001] $61'$	Along [100] $p_{2a^*} 11m'$	Along [210] $p_{2a^*} 11m'$
	$a^* = c$	$a^* = c$
Origin at 0,0,z	Origin at x,0,0	Origin at x,x/2,0

$p6_1$

6

Hexagonal

No. 54.1.276

$p6_1$

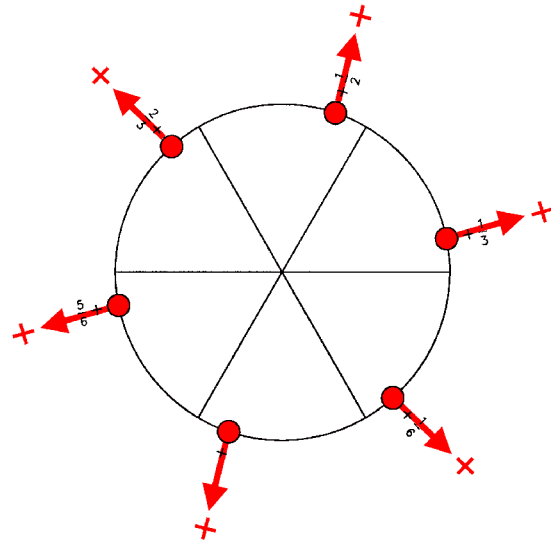
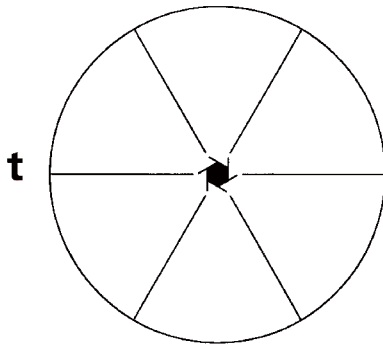

Origin on 6_1

Asymmetric unit $0 \leq z \leq 1/6$

Symmetry operations

(1) 1
(1|0,0,0)

(2) 3^+ (0,0,1/3) 0,0,z
(3_z |0,0,1/3)

(3) 3^- (0,0,2/3) 0,0,z
(3_z^{-1} |0,0,2/3)

(4) 2 (0,0,1/2) 0,0,z
(2_z |0,0,1/2)

(5) 6^- (0,0,5/6) 0,0,z
(6_z^{-1} |0,0,5/6)

(6) 6^+ (0,0,1/6) 0,0,z
(6_z |0,0,1/6)

Generators selected (1); $t(0,0,1)$; (2); (4)

Positions

Multiplicity, Wyckoff letter, Site symmetry	Coordinates		
	(1) x, y, z [u,v,w]	(2) $\bar{y}, x-y, z+1/3$ [$\bar{v}, u-v, w$]	(3) $\bar{x}+y, \bar{x}, z+2/3$ [$\bar{u}+v, \bar{u}, w$]
6 a 1	(4) $\bar{x}, \bar{y}, z+1/2$ [\bar{u}, \bar{v}, w]	(5) $y, \bar{x}+y, z+5/6$ [$v, \bar{u}+v, w$]	(6) $x-y, x, z+1/6$ [$u-v, u, w$]

Symmetry of special projections

Along [001] 6	Along [100] $\rho 11g'$ $a^* = c$	Along [210] $\rho 11g'$ $a^* = c$
Origin at 0,0,z	Origin at x,0,0	Origin at x,x/2,0

$p6_11'$

$61'$

Hexagonal

No. 54.2.277

$p6_11'$

1'

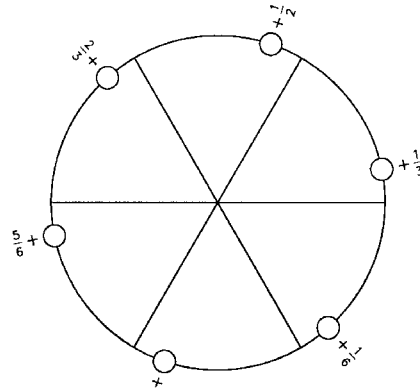
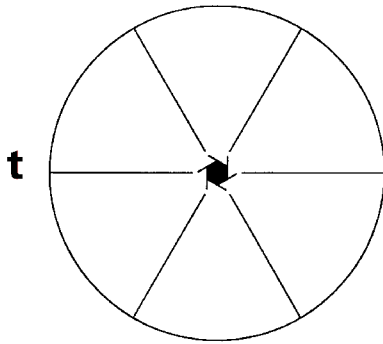

Origin on $6_11'$

Asymmetric unit $0 \leq z \leq 1/6$

Symmetry operations

For $1 +$ set

(1) 1
 $(1|0,0,0)$

(2) $3^+ (0,0,1/3) \ 0,0,z$
 $(3_z|0,0,1/3)$

(3) $3^- (0,0,2/3) \ 0,0,z$
 $(3_z^{-1}|0,0,2/3)$

(4) $2 (0,0,1/2) \ 0,0,z$
 $(2_z|0,0,1/2)$

(5) $6^- (0,0,5/6) \ 0,0,z$
 $(6_z^{-1}|0,0,5/6)$

(6) $6^+ (0,0,1/6) \ 0,0,z$
 $(6_z|0,0,1/6)$

For $1' +$ set

(1) $1'$
 $(1|0,0,0)'$

(2) $3^{+'} (0,0,1/3) \ 0,0,z$
 $(3_z|0,0,1/3)'$

(3) $3^{-'} (0,0,2/3) \ 0,0,z$
 $(3_z^{-1}|0,0,2/3)'$

(4) $2' (0,0,1/2) \ 0,0,z$
 $(2_z|0,0,1/2)'$

(5) $6^{-'} (0,0,5/6) \ 0,0,z$
 $(6_z^{-1}|0,0,5/6)'$

(6) $6^{+'} (0,0,1/6) \ 0,0,z$
 $(6_z|0,0,1/6)'$

Generators selected (1); $t(0,0,1)$; (2); (4); $1'$

Positions

Multiplicity, Wyckoff letter, Site symmetry	Coordinates		
		1+	1' +
6 a 11'	(1) x,y,z [0,0,0]	(2) $\bar{y},x-y,z+1/3$ [0,0,0]	(3) $\bar{x}+y,\bar{x},z+2/3$ [0,0,0]
	(4) $\bar{x},\bar{y},z+1/2$ [0,0,0]	(5) $y,\bar{x}+y,z+5/6$ [0,0,0]	(6) $x-y,x,z+1/6$ [0,0,0]

Symmetry of special projections

Along [001] $61'$	Along [100] $p11g1'$	Along [210] $p11g1'$
Origin at 0,0,z	$a^* = c$ Origin at x,0,0	$a^* = c$ Origin at x,x/2,0

$p6_1'$

No. 54.3.278

$6'$

$p6_1'$

Hexagonal

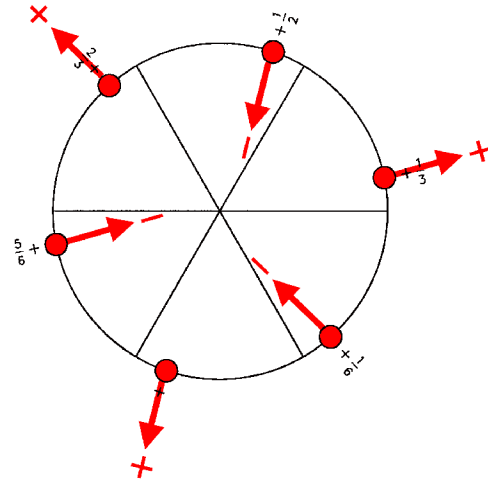
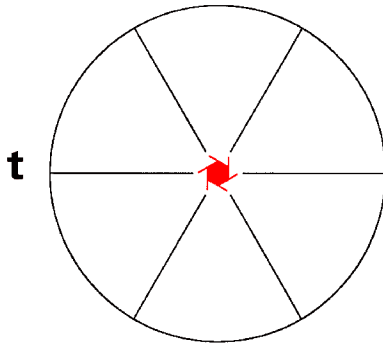

Origin on $6_1'$

Asymmetric unit $0 \leq z \leq 1/6$

Symmetry operations

(1) 1
(1|0,0,0)

(2) 3^+ (0,0,1/3) 0,0,z
(3_z |0,0,1/3)

(3) 3^- (0,0,2/3) 0,0,z
(3_z^{-1} |0,0,2/3)

(4) $2'$ (0,0,1/2) 0,0,z
(2_z |0,0,1/2)'

(5) 6^- (0,0,5/6) 0,0,z
(6_z^{-1} |0,0,5/6)'

(6) 6^+ (0,0,1/6) 0,0,z
(6_z |0,0,1/6)'

Generators selected (1); $t(0,0,1)$; (2); (4)

Positions

Multiplicity, Wyckoff letter, Site symmetry	Coordinates		
	(1) x, y, z [u,v,w]	(2) $\bar{y}, x-y, z+1/3$ [$\bar{v}, u-v, w$]	(3) $\bar{x}+y, \bar{x}, z+2/3$ [$\bar{u}+v, \bar{u}, w$]
6 a 1	(4) $\bar{x}, \bar{y}, z+1/2$ [u,v, \bar{w}]	(5) $y, \bar{x}+y, z+5/6$ [$\bar{v}, u-v, \bar{w}$]	(6) $x-y, x, z+1/6$ [$\bar{u}+v, \bar{u}, \bar{w}$]

Symmetry of special projections

Along [001] $6'$	Along [100] $\rho 11g$	Along [210] $\rho 11g$
Origin at 0,0,z	$a^* = c$ Origin at x,0,0	$a^* = c$ Origin at x,x/2,0

$p6_2$

6

Hexagonal

No. 55.1.279

$p6_2$

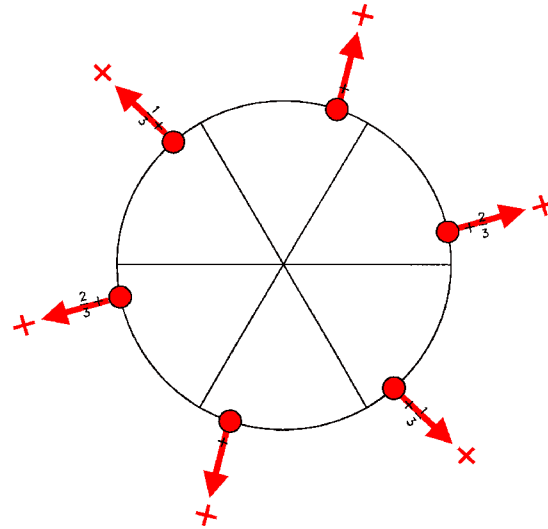
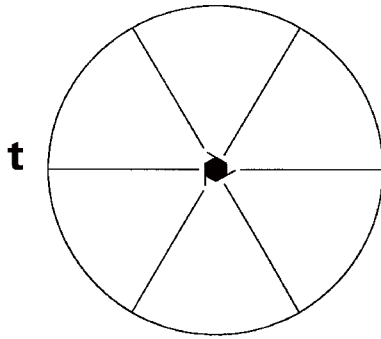

Origin on 2 on 6_2

Asymmetric unit $0 \leq x$; $0 \leq y$; $0 \leq z \leq 1$; $y \leq x$

Symmetry operations

(1) 1
(1|0,0,0)

(2) 3^+ (0,0,2/3) 0,0,z
(3_z |0,0,2/3)

(3) 3^- (0,0,1/3) 0,0,z
(3_z^{-1} |0,0,1/3)

(4) 2 0,0,z
(2_z |0,0,0)

(5) 6^- (0,0,2/3) 0,0,z
(6_z^{-1} |0,0,2/3)

(6) 6^+ (0,0,1/3) 0,0,z
(6_z |0,0,1/3)

Generators selected (1); $t(0,0,1)$; (2); (4)

Positions

Multiplicity, Wyckoff letter, Site symmetry	Coordinates		
	(1) x,y,z [u,v,w]	(2) $\bar{y},x-y,z+2/3$ [$\bar{v},u-v,w$]	(3) $\bar{x}+y,\bar{x},z+1/3$ [$\bar{u}+v,\bar{u},w$]
6 b 1	(4) \bar{x},\bar{y},z [\bar{u},\bar{v},w]	(5) $y,\bar{x}+y,z+2/3$ [$v,\bar{u}+v,w$]	(6) $x-y,x,z+1/3$ [$u-v,u,w$]
3 a 2..	$0,0,z$ [$0,0,w$]	$0,0,z+2/3$ [$0,0,w$]	$0,0,z+1/3$ [$0,0,w$]

Symmetry of special projections

Along [001] 6	Along [100] $p11m'$ $a^* = c$	Along [210] $p11m'$ $a^* = c$
Origin at $0,0,z$	Origin at $x,0,0$	Origin at $x,x/2,0$

$p6_21'$

No. 55.2.280

$61'$

$p6_21'$

Hexagonal

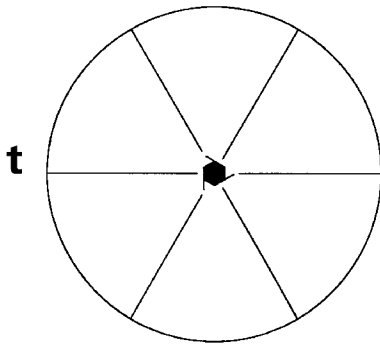

1'

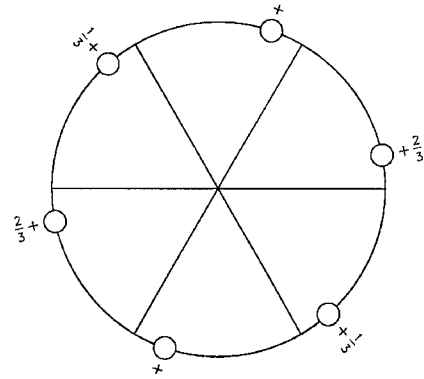

Origin on $21'$ on $6_21'$

Asymmetric unit $0 \leq x$; $0 \leq y$; $0 \leq z \leq 1$; $y \leq x$

Symmetry operations

For $1 +$ set

(1) 1
 $(1|0,0,0)$

(2) $3^+ (0,0,2/3) \ 0,0,z$
 $(3_z|0,0,2/3)$

(3) $3^- (0,0,1/3) \ 0,0,z$
 $(3_z^{-1}|0,0,1/3)$

(4) $2 \ 0,0,z$
 $(2_z|0,0,0)$

(5) $6^- (0,0,2/3) \ 0,0,z$
 $(6_z^{-1}|0,0,2/3)$

(6) $6^+ (0,0,1/3) \ 0,0,z$
 $(6_z|0,0,1/3)$

For $1' +$ set

(1) $1'$
 $(1|0,0,0)'$

(2) $3^{+'} (0,0,2/3) \ 0,0,z$
 $(3_z|0,0,2/3)'$

(3) $3^{-'} (0,0,1/3) \ 0,0,z$
 $(3_z^{-1}|0,0,1/3)'$

(4) $2'$ $0,0,z$
 $(2_z|0,0,0)'$

(5) $6^{-'} (0,0,2/3) \ 0,0,z$
 $(6_z^{-1}|0,0,2/3)'$

(6) $6^{+'} (0,0,1/3) \ 0,0,z$
 $(6_z|0,0,1/3)'$

Generators selected (1); $t(0,0,1)$; (2); (4); $1'$

Positions

Multiplicity, Wyckoff letter, Site symmetry	Coordinates		
		1+	1'+
6 b $11'$	(1) x,y,z [0,0,0]	(2) $\bar{y},x-y,z+2/3$ [0,0,0]	(3) $\bar{x}+y,\bar{x},z+1/3$ [0,0,0]
	(4) \bar{x},\bar{y},z [0,0,0]	(5) $y,\bar{x}+y,z+2/3$ [0,0,0]	(6) $x-y,x,z+1/3$ [0,0,0]
3 a $2..1'$	$0,0,z$ [0,0,0]	$0,0,z+2/3$ [0,0,0]	$0,0,z+1/3$ [0,0,0]

Symmetry of special projections

Along [001] $61'$	Along [100] $\rho 11m1'$ $a^* = c$	Along [210] $\rho 11m1'$ $a^* = c$
Origin at 0,0,z	Origin at x,0,0	Origin at x,x/2,0

$p6_2'$

No. 55.3.181

$6'$

$p6_2'$

Hexagonal

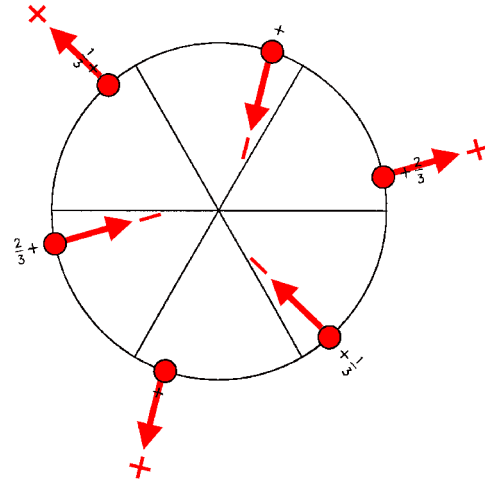
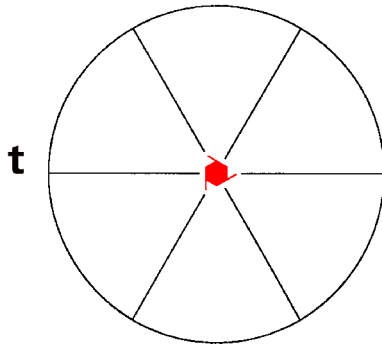

Origin on $2'$ on $6_2'$

Asymmetric unit $0 \leq x; 0 \leq y; 0 \leq z \leq 1; y \leq x$

Symmetry operations

(1) 1
(1|0,0,0)

(2) 3^+ (0,0,2/3) 0,0,z
(3_z |0,0,2/3)

(3) 3^- (0,0,1/3) 0,0,z
(3_z^{-1} |0,0,1/3)

(4) $2'$ 0,0,z
(2_z |0,0,0)'

(5) 6^+ (0,0,2/3) 0,0,z
(6_z^+ |0,0,2/3)'

(6) 6^{+-} (0,0,1/3) 0,0,z
(6_z^{+-} |0,0,1/3)'

Generators selected (1); $t(0,0,1)$; (2); (4)

Positions

Multiplicity, Wyckoff letter, Site symmetry	Coordinates		
	(1) x, y, z [u, v, w]	(2) $\bar{y}, x-y, z+2/3$ [$\bar{v}, u-v, w$]	(3) $\bar{x}+y, \bar{x}, z+1/3$ [$\bar{u}+v, \bar{u}, w$]
6 b 1	(4) \bar{x}, \bar{y}, z [u, v, \bar{w}]	(5) $y, \bar{x}+y, z+2/3$ [$\bar{v}, u-v, \bar{w}$]	(6) $x-y, x, z+1/3$ [$\bar{u}+v, \bar{u}, \bar{w}$]
	3 a 2'..	0,0,z [u,v,0]	0,0,z+2/3 [$\bar{v}, u-v, 0$]
			0,0,z+1/3 [$\bar{u}+v, \bar{u}, 0$]

Symmetry of special projections

Along [001] $6'$	Along [100] $\rho 11m$ $a^* = c$	Along [210] $\rho 11m$ $a^* = c$
Origin at 0,0,z	Origin at x,0,0	Origin at x,x/2,0

$p_{2c}6_2$

$61'$

Hexagonal

No. 55.4.282

$p_{2c}6_2$

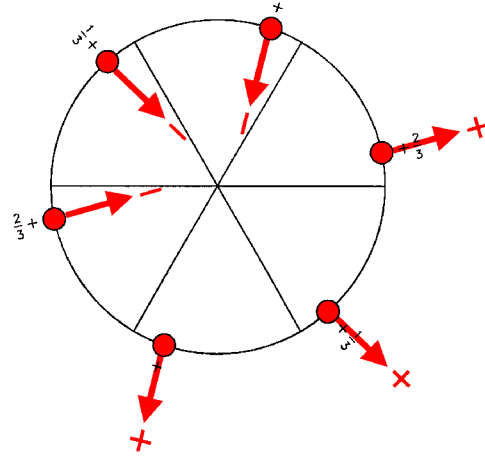
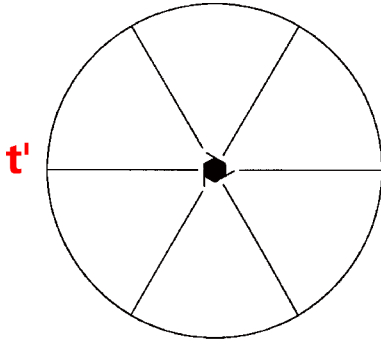

Origin on $2'$ on 6_2

Asymmetric unit $0 \leq x; 0 \leq y; 0 \leq z \leq 1; y \leq x$

Symmetry operations

For $(0,0,0) +$ set

(1) 1
 $(1|0,0,0)$

(2) $3^+ (0,0,2/3) \ 0,0,z$
 $(3_z|0,0,2/3)$

(3) $3^- (0,0,1/3) \ 0,0,z$
 $(3_z^{-1}|0,0,1/3)'$

(4) $2' \ 0,0,z$
 $(2_z|0,0,0)'$

(5) $6^- (0,0,2/3) \ 0,0,z$
 $(6_z^{-1}|0,0,2/3)'$

(6) $6^+ (0,0,1/3) \ 0,0,z$
 $(6_z|0,0,1/3)$

For $(0,0,1) +$ set

(1) $t' (0,0,1)$
 $(1|0,0,1)'$

(2) $3^+ (0,0,5/3) \ 0,0,z$
 $(3_z|0,0,5/3)'$

(3) $3^- (0,0,4/3) \ 0,0,z$
 $(3_z^{-1}|0,0,4/3)$

(4) $2 (0,0,1) \ 0,0,z$
 $(2_z|0,0,1)$

(5) $6^- (0,0,5/3) \ 0,0,z$
 $(6_z^{-1}|0,0,5/3)$

(6) $6^+ (0,0,4/3) \ 0,0,z$
 $(6_z|0,0,4/3)'$

Generators selected (1); $t(0,0,1)'$; (2); (4)

Positions

Multiplicity, Wyckoff letter, Site symmetry	Coordinates		
		(0,0,0)+	(0,0,1)' +
6 b 1	(1) $x,y,z [u,v,w]$	(2) $\bar{y},x-y,z+2/3 [\bar{v},u-v,w]$	(3) $\bar{x}+y,\bar{x},z+1/3 [u-v,u,\bar{w}]$
	(4) $\bar{x},\bar{y},z [u,v,\bar{w}]$	(5) $y,\bar{x}+y,z+2/3 [\bar{v},u-v,\bar{w}]$	(6) $x-y,x,z+1/3 [u-v,u,w]$
3 a 2'..	0,0,z [u,v,0]	0,0,z+2/3 [$\bar{v},u-v,0$]	0,0,z+1/3 [u-v,u,0]

Symmetry of special projections

Along [001] 61'	Along [100] $\rho_{2a^*} 11m'$ $a^* = c$	Along [210] $\rho_{2a^*} 11m'$ $a^* = c$
Origin at 0,0,z	Origin at x,0,0	Origin at x,x/2,0

$P_{2c}6_2'$

6

Hexagonal

No. 55.5.283

$P_{2c}6_2'$

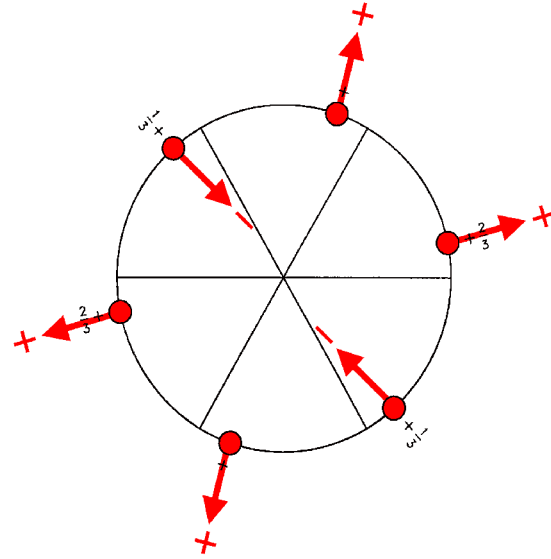
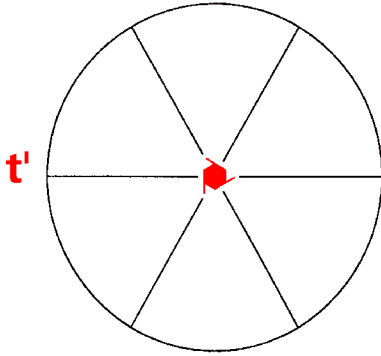

Origin on 2 on $6_2'$

Asymmetric unit $0 \leq x; 0 \leq y; 0 \leq z \leq 1; y \leq x$

Symmetry operations

For $(0,0,0)$ + set

- | | | |
|--------------------------------|---|--|
| (1) 1
(1 0,0,0) | (2) 3^+ (0,0,2/3) 0,0,z
(3_z 0,0,2/3) | (3) 3^- (0,0,1/3) 0,0,z
(3_z^{-1} 0,0,1/3)' |
| (4) 2 0,0,z
(2_z 0,0,0) | (5) 6^- (0,0,2/3) 0,0,z
(6_z^{-1} 0,0,2/3) | (6) 6^{+-} (0,0,1/3) 0,0,z
(6_z 0,0,1/3)' |

For $(0,0,1)$ + set

- | | | |
|--|--|---|
| (1) t' (0,0,1)
(1 0,0,1)' | (2) 3^{+-} (0,0,5/3) 0,0,z
(3_z 0,0,5/3)' | (3) 3^- (0,0,4/3) 0,0,z
(3_z^{-1} 0,0,4/3) |
| (4) $2'$ (0,0,1) 0,0,z
(2_z 0,0,1)' | (5) 6^- (0,0,5/3) 0,0,z
(6_z^{-1} 0,0,5/3)' | (6) 6^+ (0,0,4/3) 0,0,z
(6_z 0,0,4/3) |

Generators selected (1); $t(0,0,1)'$; (2); (4)

Positions

Multiplicity, Wyckoff letter, Site symmetry	Coordinates		
		(0,0,0)+	(0,0,1)' +
6 b 1	(1) $x,y,z [u,v,w]$	(2) $\bar{y},x-y,z+2/3 [\bar{v},u-v,w]$	(3) $\bar{x}+y,\bar{x},z+1/3 [u-v,u,\bar{w}]$
	(4) $\bar{x},\bar{y},z [\bar{u},\bar{v},w]$	(5) $y,\bar{x}+y,z+2/3 [v,\bar{u}+v,w]$	(6) $x-y,x,z+1/3 [\bar{u}+v,\bar{u},\bar{w}]$
3 a 2..	0,0,z [0,0,w]	0,0,z+2/3 [0,0,w]	0,0,z+1/3 [0,0, \bar{w}]

Symmetry of special projections

Along [001] $6'$	Along [100] $p_{2a^*} 11m$ $a^* = c$	Along [210] $p_{2a^*} 11m$ $a^* = c$
Origin at 0,0,z	Origin at x,0,0	Origin at x,x/2,0

$p6_3$

6

Hexagonal

No. 56.1.284

$p6_3$

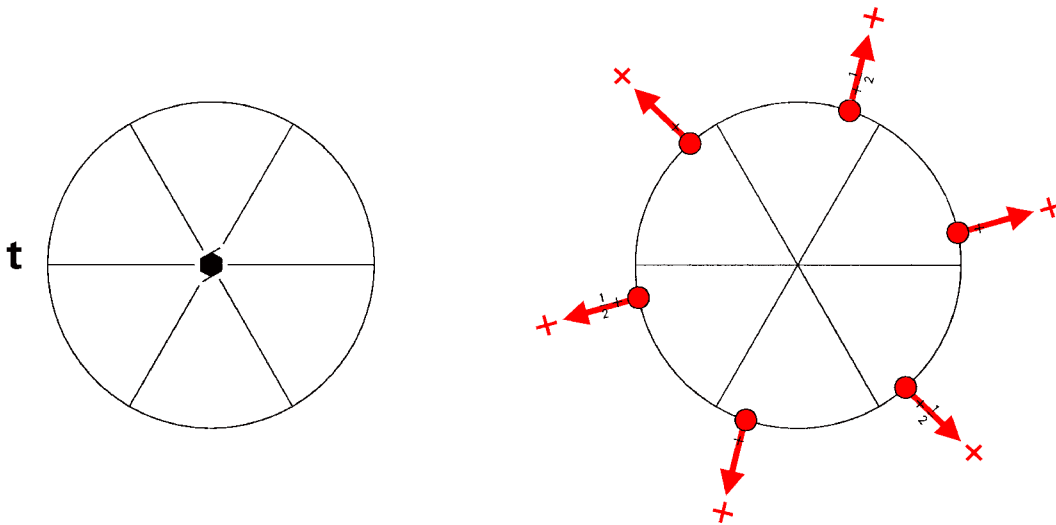

Origin on 3 on 6_3

Asymmetric unit $0 \leq x; 0 \leq y; 0 \leq z \leq 1; y \leq x$

Symmetry operations

$$(1) 1 \\ (1|0,0,0)$$

$$(2) 3^+ 0,0,z \\ (3_z|0,0,0)$$

$$(3) 3^- 0,0,z \\ (3_z^{-1}|0,0,0)$$

$$(4) 2 (0,0,1/2) 0,0,z \\ (2_z|0,0,1/2)$$

$$(5) 6^- (0,0,1/2) 0,0,z \\ (6_z^{-1}|0,0,1/2)$$

$$(6) 6^+ (0,0,1/2) 0,0,z \\ (6_z|0,0,1/2)$$

Generators selected (1); $t(0,0,1)$; (2); (4)

Positions

Multiplicity, Wyckoff letter, Site symmetry	Coordinates		
	(1) x,y,z [u,v,w]	(2) $\bar{y},x-y,z$ [$\bar{v},u-v,w$]	(3) $\bar{x}+y,\bar{x},z$ [$\bar{u}+v,\bar{u},w$]
6 b 1	(4) $\bar{x},\bar{y},z+1/2$ [\bar{u},\bar{v},w]	(5) $y,\bar{x}+y,z+1/2$ [$v,\bar{u}+v,w$]	(6) $x-y,x,z+1/2$ [$u-v,u,w$]
3 a 3..	$0,0,z$ [$0,0,w$]	$0,0,z+1/2$ [$0,0,w$]	

Symmetry of special projections

Along [001] 6	Along [100] $p11g'$ $a^* = c$	Along [210] $p11g'$ $a^* = c$
Origin at $0,0,z$	Origin at $x,0,0$	Origin at $x,x/2,0$

$p6_31'$

$61'$

Hexagonal

No. 56.2.285

$p6_31'$

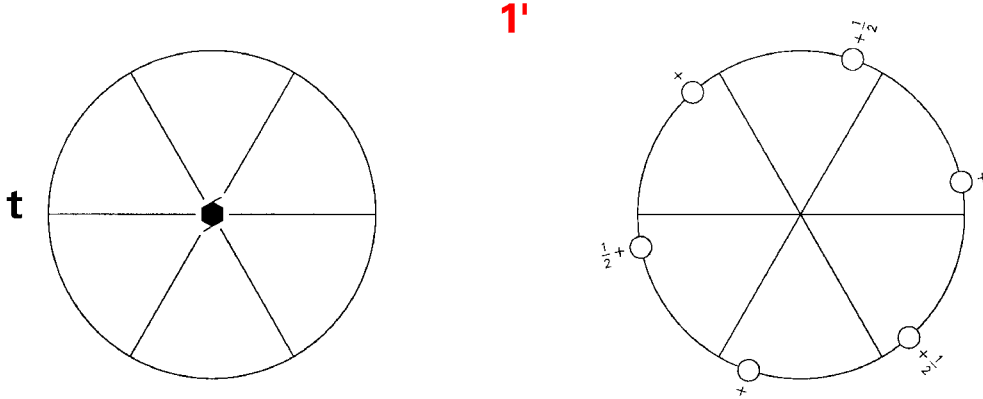

Origin on $31'$ on $6_31'$

Asymmetric unit $0 \leq x; 0 \leq y; 0 \leq z \leq 1; y \leq x$

Symmetry operations

For $1 +$ set

(1) 1
($1|0,0,0$)

(2) 3^+ $0,0,z$
($3_z|0,0,0$)

(3) 3^- $0,0,z$
($3_z^{-1}|0,0,0$)

(4) 2 $(0,0,1/2) \ 0,0,z$
($2_z|0,0,1/2$)

(5) 6^- $(0,0,1/2) \ 0,0,z$
($6_z^{-1}|0,0,1/2$)

(6) 6^+ $(0,0,1/2) \ 0,0,z$
($6_z|0,0,1/2$)

For $1' +$ set

(1) $1'$
($1|0,0,0'$)

(2) $3^{+'}$ $0,0,z$
($3_z|0,0,0'$)

(3) $3^{-'}$ $0,0,z$
($3_z^{-1}|0,0,0'$)

(4) $2'$ $(0,0,1/2) \ 0,0,z$
($2_z|0,0,1/2'$)

(5) $6^{-'}$ $(0,0,1/2) \ 0,0,z$
($6_z^{-1}|0,0,1/2'$)

(6) $6^{+'}$ $(0,0,1/2) \ 0,0,z$
($6_z|0,0,1/2'$)

Generators selected (1); $t(0,0,1)$; (2); (4); $1'$

Positions

Multiplicity, Wyckoff letter, Site symmetry	Coordinates		
		$1+$	$1' +$
6 b $11'$	(1) $x,y,z [0,0,0]$	(2) $\bar{y},x-y,z [0,0,0]$	(3) $\bar{x}+y,\bar{x},z [0,0,0]$
	(4) $\bar{x},\bar{y},z+1/2 [0,0,0]$	(5) $y,\bar{x}+y,z+1/2 [0,0,0]$	(6) $x-y,x,z+1/2 [0,0,0]$
3 a $3..1'$	$0,0,z [0,0,0]$	$0,0,z+1/2 [0,0,0]$	

Symmetry of special projections

Along $[001] 61'$	Along $[100] p11g1'$	Along $[210] p11g1'$
Origin at $0,0,z$	$a^* = c$ Origin at $x,0,0$	$a^* = c$ Origin at $x,x/2,0$

$p6_3'$

No. 56.3.286

$6'$

$p6_3'$

Hexagonal

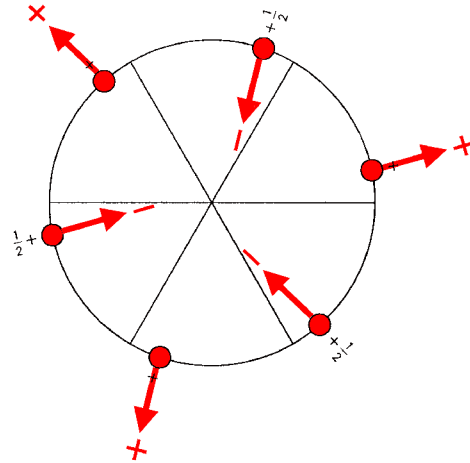
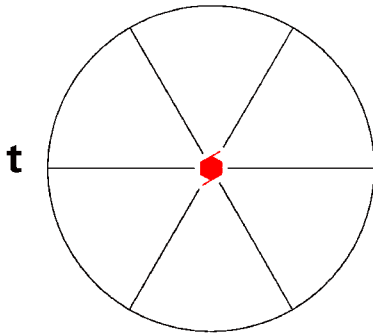

Origin on 3 on $6_3'$

Asymmetric unit $0 \leq x; 0 \leq y; 0 \leq z \leq 1; y \leq x$

Symmetry operations

- | | | |
|--|---|---|
| (1) 1
(1 0,0,0) | (2) 3^+ 0,0,z
(3_z 0,0,0) | (3) 3^- 0,0,z
(3_z^{-1} 0,0,0) |
| (4) $2'$ (0,0,1/2) 0,0,z
(2_z 0,0,1/2)' | (5) 6^+ (0,0,1/2) 0,0,z
(6_z^+ 0,0,1/2)' | (6) 6^- (0,0,1/2) 0,0,z
(6_z^- 0,0,1/2)' |

Generators selected (1); $t(0,0,1)$; (2); (4)

Positions

Multiplicity, Wyckoff letter, Site symmetry	Coordinates		
	(1) x,y,z [u,v,w]	(2) $\bar{y},x-y,z$ [$\bar{v},u-v,w$]	(3) $\bar{x}+y,\bar{x},z$ [$\bar{u}+v,\bar{u},w$]
6 b 1	(4) $\bar{x},\bar{y},z+1/2$ [u,v, \bar{w}]	(5) $y,\bar{x}+y,z+1/2$ [$\bar{v},u-v,\bar{w}$]	(6) $x-y,x,z+1/2$ [$\bar{u}+v,\bar{u},\bar{w}$]
3 a 3..	0,0,z [0,0,w]	0,0,z+1/2 [0,0, \bar{w}]	

Symmetry of special projections

Along [001] $6'$	Along [100] $\rho 11g$ $a^* = c$	Along [210] $\rho 11g$ $a^* = c$
Origin at 0,0,z	Origin at x,0,0	Origin at x,x/2,0

$p6_4$

6

Hexagonal

No. 57.1.287

$p6_4$

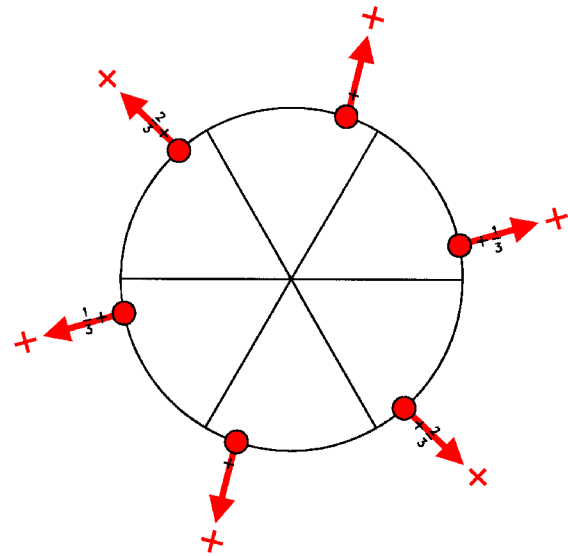
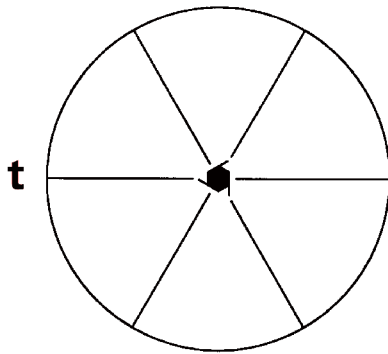

Origin on 2 on 6_4

Asymmetric unit $0 \leq x; 0 \leq y; 0 \leq z \leq 1; y \leq x$

Symmetry operations

(1) 1
(1|0,0,0)

(2) 3^+ (0,0,1/3) 0,0,z
(3_z |0,0,1/3)

(3) 3^- (0,0,2/3) 0,0,z
(3_z^{-1} |0,0,2/3)

(4) 2 0,0,z
(2_z |0,0,0)

(5) 6^- (0,0,1/3) 0,0,z
(6_z^{-1} |0,0,1/3)

(6) 6^+ (0,0,2/3) 0,0,z
(6_z |0,0,2/3)

Generators selected (1); $t(0,0,1)$; (2); (4)

Positions

Multiplicity, Wyckoff letter, Site symmetry	Coordinates		
	(1) x,y,z [u,v,w]	(2) $\bar{y},x-y,z+1/3$ [$\bar{v},u-v,w$]	(3) $\bar{x}+y,\bar{x},z+2/3$ [$\bar{u}+v,\bar{u},w$]
6 b 1	(4) \bar{x},\bar{y},z [\bar{u},\bar{v},w]	(5) $y,\bar{x}+y,z+1/3$ [$v,\bar{u}+v,w$]	(6) $x-y,x,z+2/3$ [$u-v,u,w$]
	3 a 2..	$0,0,z$ [$0,0,w$]	$0,0,z+1/3$ [$0,0,w$]
			$0,0,z+2/3$ [$0,0,w$]

Symmetry of special projections

Along [001] 6	Along [100] $p11m'$ $a^* = c$	Along [210] $p11m'$ $a^* = c$
Origin at $0,0,z$	Origin at $x,0,0$	Origin at $x,x/2,0$

$p6_41'$

$61'$

Hexagonal

No. 57.2.288

$p6_41'$

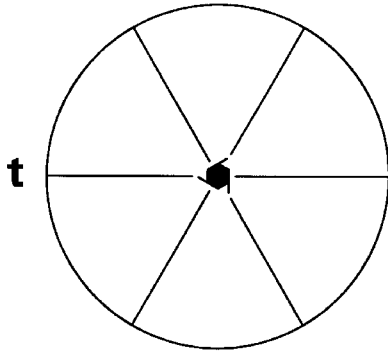

$1'$

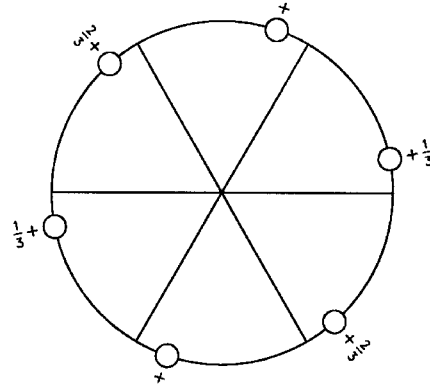

Origin on $21'$ on $6_41'$

Asymmetric unit $0 \leq x; 0 \leq y; 0 \leq z \leq 1; y \leq x$

Symmetry operations

For $1 +$ set

$$(1) 1 \\ (1|0,0,0)$$

$$(2) 3^+ (0,0,1/3) \ 0,0,z \\ (3_z|0,0,1/3)$$

$$(3) 3^- (0,0,2/3) \ 0,0,z \\ (3_z^{-1}|0,0,2/3)$$

$$(4) 2 \ 0,0,z \\ (2_z|0,0,0)$$

$$(5) 6^- (0,0,1/3) \ 0,0,z \\ (6_z^{-1}|0,0,1/3)$$

$$(6) 6^+ (0,0,2/3) \ 0,0,z \\ (6_z|0,0,2/3)$$

For $1' +$ set

$$(1) 1' \\ (1|0,0,0)'$$

$$(2) 3^{+'} (0,0,1/3) \ 0,0,z \\ (3_z|0,0,1/3)'$$

$$(3) 3^{-'} (0,0,2/3) \ 0,0,z \\ (3_z^{-1}|0,0,2/3)'$$

$$(4) 2' \ 0,0,z \\ (2_z|0,0,0)'$$

$$(5) 6^{-'} (0,0,1/3) \ 0,0,z \\ (6_z^{-1}|0,0,1/3)'$$

$$(6) 6^{+'} (0,0,2/3) \ 0,0,z \\ (6_z|0,0,2/3)'$$

Generators selected (1); $t(0,0,1)$; (2); (4); $1'$

Positions

Multiplicity, Wyckoff letter, Site symmetry	Coordinates		
		$1+$	$1' +$
6 b $11'$	(1) x,y,z [0,0,0]	(2) $\bar{y},x-y,z+1/3$ [0,0,0]	(3) $\bar{x}+y,\bar{x},z+2/3$ [0,0,0]
	(4) \bar{x},\bar{y},z [0,0,0]	(5) $y,\bar{x}+y,z+1/3$ [0,0,0]	(6) $x-y,x,z+2/3$ [0,0,0]
3 a $2..1'$	$0,0,z$ [0,0,0]	$0,0,z+1/3$ [0,0,0]	$0,0,z+2/3$ [0,0,0]

Symmetry of special projections

Along [001] $61'$	Along [100] $p11m1'$ $a^* = c$	Along [210] $p11m1'$ $a^* = c$
Origin at $0,0,z$	Origin at $x,0,0$	Origin at $x,x/2,0$

$p6_4'$

No. 57.3.289

$6'$

$p6_4'$

Hexagonal

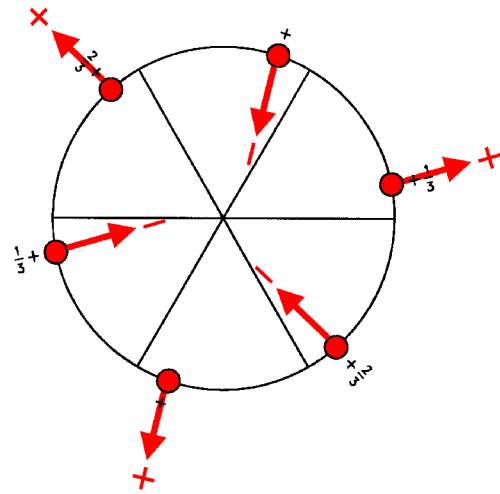
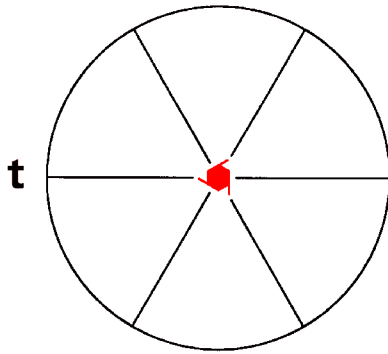

Origin on $2'$ on $6_4'$

Asymmetric unit $0 \leq x; 0 \leq y; 0 \leq z \leq 1; y \leq x$

Symmetry operations

(1) 1
(1|0,0,0)

(2) 3^+ (0,0,1/3) 0,0,z
(3_z |0,0,1/3)

(3) 3^- (0,0,2/3) 0,0,z
(3_z^{-1} |0,0,2/3)

(4) $2'$ 0,0,z
(2_z |0,0,0)'

(5) 6^- (0,0,1/3) 0,0,z
(6_z^{-1} |0,0,1/3)'

(6) 6^+ (0,0,2/3) 0,0,z
(6_z |0,0,2/3)'

Generators selected (1); $t(0,0,1)$; (2); (4)

Positions

	Coordinates		
Multiplicity, Wyckoff letter, Site symmetry			
6 b 1	(1) x, y, z [u, v, w]	(2) $\bar{y}, x-y, z+1/3$ [\bar{v} , u-v, w]	(3) $\bar{x}+y, \bar{x}, z+2/3$ [$\bar{u}+v, \bar{u}, w$]
	(4) \bar{x}, \bar{y}, z [u, v, \bar{w}]	(5) $y, \bar{x}+y, z+1/3$ [\bar{v} , u-v, \bar{w}]	(6) $x-y, x, z+2/3$ [$\bar{u}+v, \bar{u}, \bar{w}$]
3 a 2'..	0,0,z [u, v, 0]	0,0,z+1/3 [\bar{v} , u-v, 0]	0,0,z+2/3 [$\bar{u}+v, \bar{u}, 0$]

Symmetry of special projections

Along [001] 6'	Along [100] $\rho 11m$ $a^* = c$	Along [210] $\rho 11m$ $a^* = c$
Origin at 0,0,z	Origin at x,0,0	Origin at x,x/2,0

$P_{2c}6_4'$

No. 57.4.290

 $61'$ $P_{2c}6_4'$

Hexagonal

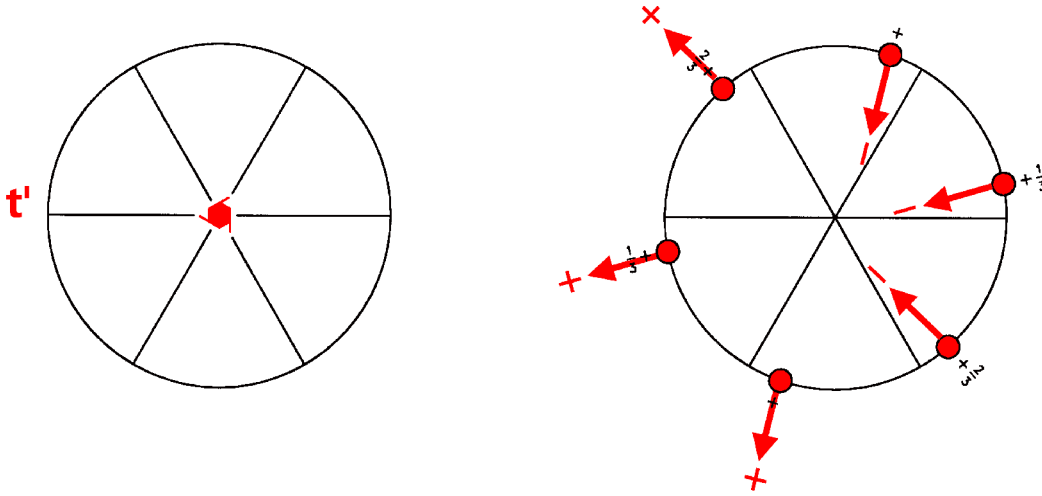
Origin on $2'$ on $6_4'$ Asymmetric unit $0 \leq x$; $0 \leq y$; $0 \leq z \leq 1$; $y \leq x$

Symmetry operations

For $(0,0,0)$ + set

- | | | |
|--------------------------------------|--|---|
| (1) 1
(1 0,0,0) | (2) 3^{+} $(0,0,1/3)$ $0,0,z$
(3_z^{-1} 0,0,1/3)' | (3) 3^{-} $(0,0,2/3)$ $0,0,z$
(3_z^{-1} 0,0,2/3) |
| (4) $2'$ $0,0,z$
(2_z 0,0,0)' | (5) 6^{-} $(0,0,1/3)$ $0,0,z$
(6_z^{-1} 0,0,1/3) | (6) 6^{+} $(0,0,2/3)$ $0,0,z$
(6_z 0,0,2/3)' |

For $(0,0,1)$ + set

- | | | |
|--|--|--|
| (1) t' $(0,0,1)$
(1 0,0,1)' | (2) 3^{+} $(0,0,4/3)$ $0,0,z$
(3_z 0,0,4/3) | (3) 3^{-} $(0,0,5/3)$ $0,0,z$
(3_z^{-1} 0,0,5/3)' |
| (4) 2 $(0,0,1)$ $0,0,z$
(2_z 0,0,1) | (5) 6^{-} $(0,0,4/3)$ $0,0,z$
(6_z^{-1} 0,0,4/3)' | (6) 6^{+} $(0,0,5/3)$ $0,0,z$
(6_z 0,0,5/3) |

Generators selected (1); $t(0,0,1)'$; (2); (4)

Positions

Multiplicity, Wyckoff letter, Site symmetry	Coordinates		
	(0,0,0)+	(0,0,1)'	
6 b 1	(1) $x,y,z [u,v,w]$	(2) $\bar{y},x-y,z+1/3 [v,\bar{u}+v,\bar{w}]$	(3) $\bar{x}+y,\bar{x},z+2/3 [\bar{u}+v,\bar{u},w]$
	(4) $\bar{x},\bar{y},z [u,v,\bar{w}]$	(5) $y,\bar{x}+y,z+1/3 [v,\bar{u}+v,w]$	(6) $x-y,x,z+2/3 [\bar{u}+v,\bar{u},\bar{w}]$
3 a 2'..	$0,0,z [u,v,0]$	$0,0,z+1/3 [v,\bar{u}+v,0]$	$0,0,z+2/3 [\bar{u}+v,\bar{u},0]$

Symmetry of special projections

Along [001] $61'$	Along [100] $p_{2a^*} 11m$ $a^* = c$	Along [210] $p_{2a^*} 11m$ $a^* = c$
Origin at 0,0,z	Origin at x,0,0	Origin at x,x/2,0

$P_{2c}6_4$

$61'$

Hexagonal

No. 57.5.291

$P_{2c}6_4$

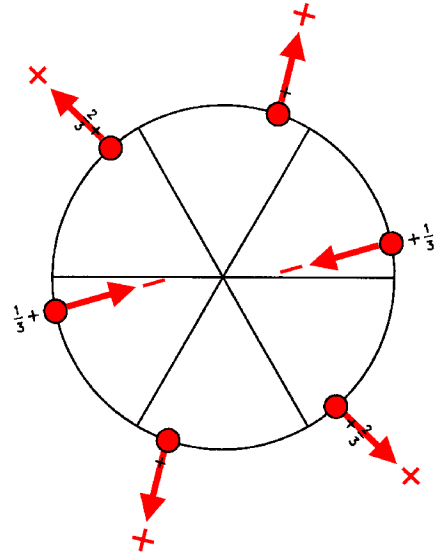
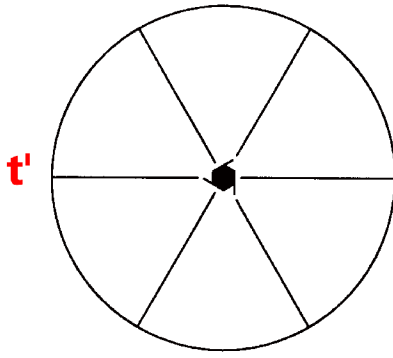

Origin on 2 on 6_4

Asymmetric unit $0 \leq x; 0 \leq y; 0 \leq z \leq 1; y \leq x$

Symmetry operations

For $(0,0,0)$ + set

- | | | |
|--------------------------------|---|---|
| (1) 1
(1 0,0,0) | (2) 3^+ (0,0,1/3) 0,0,z
(3_z 0,0,1/3) | (3) 3^- (0,0,2/3) 0,0,z
(3_z^{-1} 0,0,2/3) |
| (4) 2 0,0,z
(2_z 0,0,0) | (5) 6^- (0,0,1/3) 0,0,z
(6_z^{-1} 0,0,1/3) | (6) 6^+ (0,0,2/3) 0,0,z
(6_z 0,0,2/3) |

For $(0,0,1)'$ + set

- | | | |
|--|---|---|
| (1) t' (0,0,1)
(1 0,0,1)' | (2) $3^{+'}$ (0,0,4/3) 0,0,z
(3_z 0,0,4/3)' | (3) $3^{-'}$ (0,0,5/3) 0,0,z
(3_z^{-1} 0,0,5/3)' |
| (4) $2'$ (0,0,1) 0,0,z
(2_z 0,0,1)' | (5) $6^{-'}$ (0,0,4/3) 0,0,z
(6_z^{-1} 0,0,4/3)' | (6) $6^{+'}$ (0,0,5/3) 0,0,z
(6_z 0,0,5/3)' |

Generators selected (1); $t(0,0,1)'$; (2); (4)

Positions

Multiplicity, Wyckoff letter, Site symmetry	Coordinates		
		$(0,0,0)+$	$(0,0,1)'+$
6 b 1	(1) $x,y,z [u,v,w]$	(2) $\bar{y},x-y,z+1/3 [\bar{v},u-v,w]$	(3) $\bar{x}+y,\bar{x},z+2/3 [\bar{u}+v,\bar{u},w]$
	(4) $\bar{x},\bar{y},z [\bar{u},\bar{v},w]$	(5) $y,\bar{x}+y,z+1/3 [v,\bar{u}+v,w]$	(6) $x-y,x,z+2/3 [u-v,u,w]$
3 a 2..	$0,0,z [0,0,w]$	$0,0,z+1/3 [0,0,w]$	$0,0,z+2/3 [0,0,w]$

Symmetry of special projections

Along [001] 6	Along [100] $p_{2a^*} 11m'$ $a^* = c$	Along [210] $p_{2a^*} 11m'$ $a^* = c$
Origin at 0,0,z	Origin at x,0,0	Origin at x,x/2,0

$p6_5$

6

Hexagonal

No. 58.1.292

$p6_5$

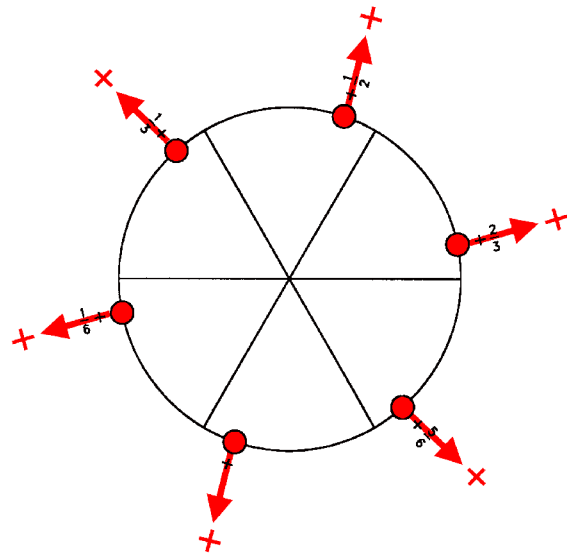
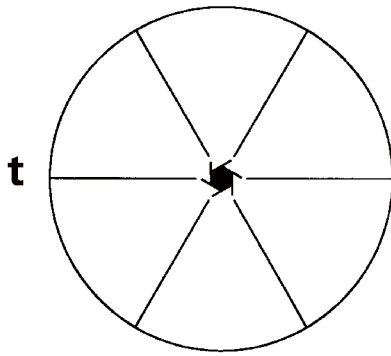

Origin on 6_5

Asymmetric unit $0 \leq z \leq 1/6$

Symmetry operations

(1) 1
(1|0,0,0)

(2) 3^+ (0,0,2/3) 0,0,z
(3_z |0,0,2/3)

(3) 3^- (0,0,1/3) 0,0,z
(3_z^{-1} |0,0,1/3)

(4) 2 (0,0,1/2) 0,0,z
(2_z |0,0,1/2)

(5) 6^- (0,0,1/6) 0,0,z
(6_z^{-1} |0,0,1/6)

(6) 6^+ (0,0,5/6) 0,0,z
(6_z |0,0,5/6)

Generators selected (1); $t(0,0,1)$; (2); (4)

Positions

Multiplicity, Wyckoff letter, Site symmetry	Coordinates		
	(1) x, y, z [u,v,w]	(2) $\bar{y}, x-y, z+2/3$ [$\bar{v}, u-v, w$]	(3) $\bar{x}+y, \bar{x}, z+1/3$ [$\bar{u}+v, \bar{u}, w$]
6 a 1	(4) $\bar{x}, \bar{y}, z+1/2$ [\bar{u}, \bar{v}, w]	(5) $y, \bar{x}+y, z+1/6$ [$v, \bar{u}+v, w$]	(6) $x-y, x, z+5/6$ [$u-v, u, w$]

Symmetry of special projections

Along [001] 6	Along [100] $p11g'$ $a^* = c$	Along [210] $p11g'$ $a^* = c$
Origin at 0,0,z	Origin at x,0,0	Origin at x,x/2,0

$p6_51'$

$61'$

Hexagonal

No. 58.2.293

$p6_51'$

1'

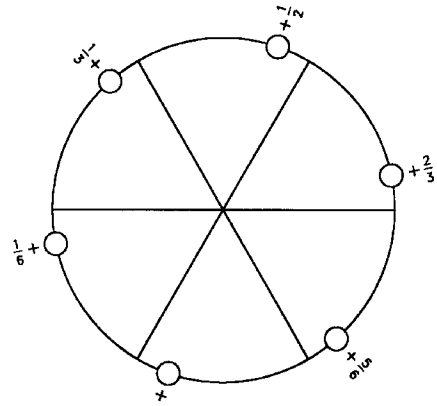
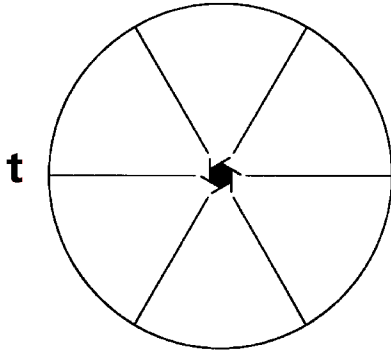

Origin on $6_51'$

Asymmetric unit $0 \leq z \leq 1/6$

Symmetry operations

For $1 +$ set

(1) 1
($1|0,0,0$)

(2) 3^+ ($0,0,2/3$) $0,0,z$
($3_z|0,0,2/3$)

(3) 3^- ($0,0,1/3$) $0,0,z$
($3_z^{-1}|0,0,1/3$)

(4) 2 ($0,0,1/2$) $0,0,z$
($2_z|0,0,1/2$)

(5) 6^- ($0,0,1/6$) $0,0,z$
($6_z^{-1}|0,0,1/6$)

(6) 6^+ ($0,0,5/6$) $0,0,z$
($6_z|0,0,5/6$)

For $1' +$ set

(1) $1'$
($1|0,0,0'$)

(2) $3^{+'}$ ($0,0,2/3$) $0,0,z$
($3_z|0,0,2/3'$)

(3) $3^{-'}$ ($0,0,1/3$) $0,0,z$
($3_z^{-1}|0,0,1/3'$)

(4) $2'$ ($0,0,1/2$) $0,0,z$
($2_z|0,0,1/2'$)

(5) $6^{+'}$ ($0,0,1/6$) $0,0,z$
($6_z^{-1}|0,0,1/6'$)

(6) $6^{+'}$ ($0,0,5/6$) $0,0,z$
($6_z|0,0,5/6'$)

Generators selected (1); $t(0,0,1)$; (2); (4); $1'$

Positions

Multiplicity, Wyckoff letter, Site symmetry	Coordinates		
		1+	1' +
6 a 11'	(1) x,y,z [0,0,0]	(2) $\bar{y},x-y,z+2/3$ [0,0,0]	(3) $\bar{x}+y,\bar{x},z+1/3$ [0,0,0]
	(4) $\bar{x},\bar{y},z+1/2$ [0,0,0]	(5) $y,\bar{x}+y,z+1/6$ [0,0,0]	(6) $x-y,x,z+5/6$ [0,0,0]

Symmetry of special projections

Along [001] $61'$	Along [100] $\rho 11g1'$	Along [210] $\rho 11g1'$
Origin at 0,0,z	$a^* = c$ Origin at x,0,0	$a^* = c$ Origin at x,x/2,0

$p6_5'$

No. 58.3.294

$6'$

$p6_5'$

Hexagonal

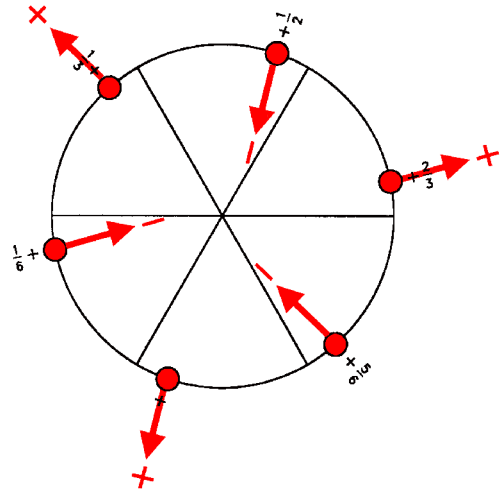
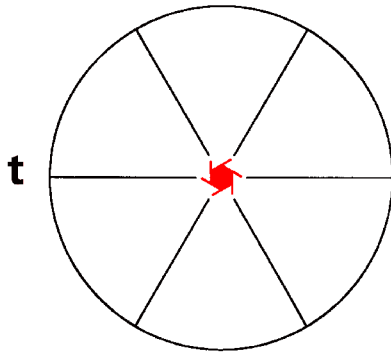

Origin on $6_5'$

Asymmetric unit $0 \leq z \leq 1/6$

Symmetry operations

$$(1) 1 \\ (1|0,0,0)$$

$$(2) 3^+ (0,0,2/3) \quad 0,0,z \\ (3_z|0,0,2/3)$$

$$(3) 3^- (0,0,1/3) \quad 0,0,z \\ (3_z^{-1}|0,0,1/3)$$

$$(4) 2' (0,0,1/2) \quad 0,0,z \\ (2_z|0,0,1/2)'$$

$$(5) 6^- (0,0,1/6) \quad 0,0,z \\ (6_z^{-1}|0,0,1/6)'$$

$$(6) 6^+ (0,0,5/6) \quad 0,0,z \\ (6_z|0,0,5/6)'$$

Generators selected (1); $t(0,0,1)$; (2); (4)

Positions

	Coordinates		
Multiplicity, Wyckoff letter, Site symmetry			
6 a 1	(1) x,y,z [u,v,w]	(2) $\bar{y},x-y,z+2/3$ [$\bar{v},u-v,w$]	(3) $\bar{x}+y,\bar{x},z+1/3$ [$\bar{u}+v,\bar{u},w$]
	(4) $\bar{x},\bar{y},z+1/2$ [u,v, \bar{w}]	(5) $y,\bar{x}+y,z+1/6$ [$\bar{v},u-v,\bar{w}$]	(6) $x-y,x,z+5/6$ [$\bar{u}+v,\bar{u},\bar{w}$]

Symmetry of special projections

Along [001] $6'$	Along [100] $p11g$	Along [210] $p11g$
	$a^* = c$	$a^* = c$
Origin at 0,0,z	Origin at x,0,0	Origin at x,x/2,0

$p\bar{6}$

No. 59.1.295

$\bar{6}$

$p\bar{6}$

Hexagonal

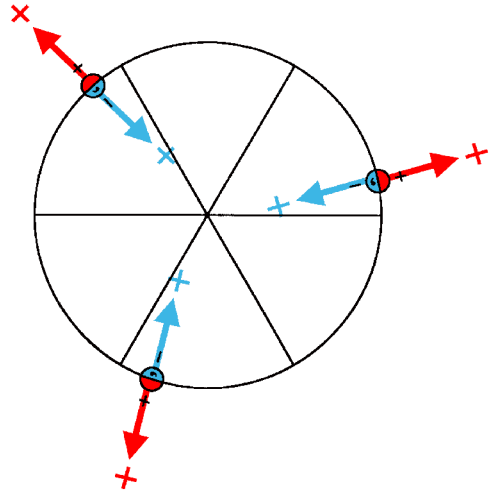
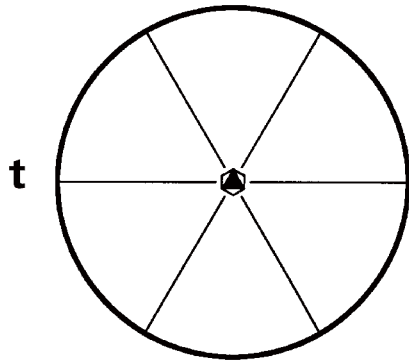

Origin at $\bar{6}$

Asymmetric unit $0 \leq x; 0 \leq y; 0 \leq z \leq 1/2$

Symmetry operations

(1) 1
(1|0,0,0)

(2) 3^+ 0,0,z
(3_z |0,0,0)

(3) 3^- 0,0,z
(3_z^{-1} |0,0,0)

(4) m x,y,0
(m_z |0,0,0)

(5) $\bar{6}^-$ 0,0,z; 0,0,0
($\bar{6}_z^{-1}$ |0,0,0)

(6) $\bar{6}^+$ 0,0,z; 0,0,0
($\bar{6}_z$ |0,0,0)

Generators selected (1); $t(0,0,1)$; (2); (4)

Positions

Multiplicity, Wyckoff letter, Site symmetry	Coordinates		
	(1) x,y,z [u,v,w]	(2) $\bar{y},x-y,z$ [$\bar{v},u-v,w$]	(3) $\bar{x}+y,\bar{x},z$ [$\bar{u}+v,\bar{u},w$]
6 f 1	(4) x,y,\bar{z} [\bar{u},\bar{v},w]	(5) $\bar{y},x-y,\bar{z}$ [$v,\bar{u}+v,w$]	(6) $\bar{x}+y,\bar{x},\bar{z}$ [$u-v,u,w$]
3 e m..	$x,y,1/2$ [$0,0,w$]	$\bar{y},x-y,1/2$ [$0,0,w$]	$\bar{x}+y,\bar{x},1/2$ [$0,0,w$]
3 d m..	$x,y,0$ [$0,0,w$]	$\bar{y},x-y,0$ [$0,0,w$]	$\bar{x}+y,\bar{x},0$ [$0,0,w$]
2 c 3..	$0,0,z$ [$0,0,w$]	$0,0,\bar{z}$ [$0,0,w$]	
1 b $\bar{6}$..	$0,0,1/2$ [$0,0,w$]		
1 a $\bar{6}$..	$0,0,0$ [$0,0,w$]		

Symmetry of special projections

Along [001] $31'$	Along [100] $p1m1$ $a^* = c$	Along [210] $p1m1$ $a^* = c$
Origin at $0,0,z$	Origin at $x,0,0$	Origin at $x,x/2,0$

$\bar{p}\bar{6}1'$

No. 59.2.296

$\bar{6}1'$

$\bar{p}\bar{6}1'$

Hexagonal

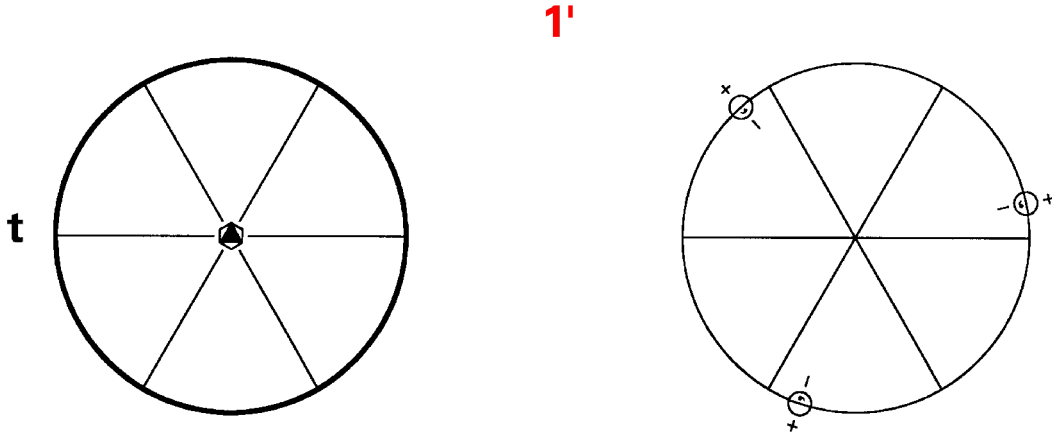

Origin at $\bar{6}1'$

Asymmetric unit $0 \leq x; 0 \leq y; 0 \leq z \leq 1/2$

Symmetry operations

For $1 +$ set

(1) 1
($1|0,0,0$)

(2) 3^+ $0,0,z$
($3_z|0,0,0$)

(3) 3^- $0,0,z$
($3_z^{-1}|0,0,0$)

(4) m $x,y,0$
($m_z|0,0,0$)

(5) $\bar{6}^-$ $0,0,z; 0,0,0$
($\bar{6}_z^{-1}|0,0,0$)

(6) $\bar{6}^+$ $0,0,z; 0,0,0$
($\bar{6}_z|0,0,0$)

For $1' +$ set

(1) $1'$
($1|0,0,0$)'

(2) $3^{+'}$ $0,0,z$
($3_z|0,0,0$)'

(3) $3^{-'}$ $0,0,z$
($3_z^{-1}|0,0,0$)'

(4) m' $x,y,0$
($m_z|0,0,0$)'

(5) $\bar{6}^{-'}$ $0,0,z; 0,0,0$
($\bar{6}_z^{-1}|0,0,0$)'

(6) $\bar{6}^{+'}$ $0,0,z; 0,0,0$
($\bar{6}_z|0,0,0$)'

Generators selected (1); $t(0,0,1)$; (2); (4); $1'$

Positions

Multiplicity, Wyckoff letter, Site symmetry	Coordinates		
	$1+$	$1' +$	
6 f $11'$	(1) $x,y,z [0,0,0]$	(2) $\bar{y},x-y,z [0,0,0]$	(3) $\bar{x}+y,\bar{x},z [0,0,0]$
	(4) $x,y,\bar{z} [0,0,0]$	(5) $\bar{y},x-y,\bar{z} [0,0,0]$	(6) $\bar{x}+y,\bar{x},\bar{z} [0,0,0]$
3 e $m..1'$	$x,y,1/2 [0,0,0]$	$\bar{y},x-y,1/2 [0,0,0]$	$\bar{x}+y,\bar{x},1/2 [0,0,0]$
3 d $m..1'$	$x,y,0 [0,0,0]$	$\bar{y},x-y,0 [0,0,0]$	$\bar{x}+y,\bar{x},0 [0,0,0]$
2 c $3..1'$	$0,0,z [0,0,0]$	$0,0,\bar{z} [0,0,0]$	
1 b $\bar{6}..1'$	$0,0,1/2 [0,0,0]$		
1 a $\bar{6}..1'$	$0,0,0 [0,0,0]$		

Symmetry of special projections

Along [001] $31'$	Along [100] $p1m11'$	Along [210] $p1m11'$
Origin at $0,0,z$	$a^* = c$ Origin at $x,0,0$	$a^* = c$ Origin at $x,x/2,0$

$p\bar{6}'$

No. 59.3.297

$\bar{6}'$

$p\bar{6}'$

Hexagonal

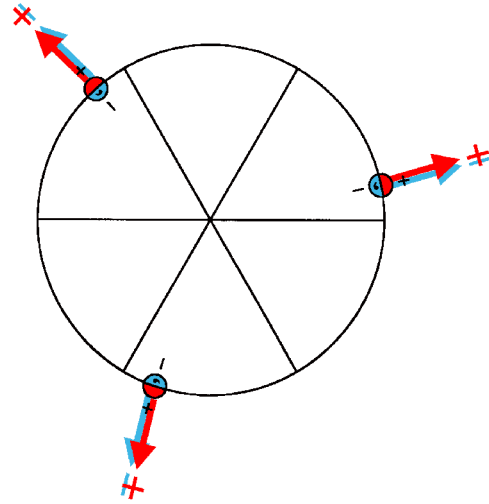
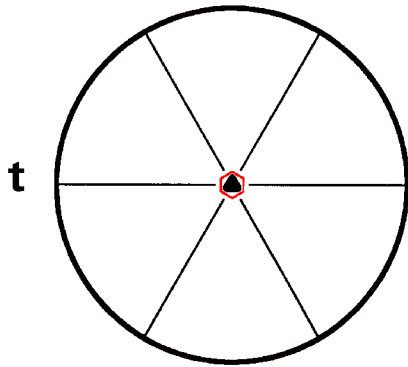

Origin at $\bar{6}'$

Asymmetric unit $0 \leq x; 0 \leq y; 0 \leq z \leq 1/2$

Symmetry operations

$$(1) 1 \\ (1|0,0,0)$$

$$(2) 3^+ \ 0,0,z \\ (3_z|0,0,0)$$

$$(3) 3^- \ 0,0,z \\ (3_z^{-1}|0,0,0)$$

$$(4) m' \ x,y,0 \\ (m_z|0,0,0)'$$

$$(5) \bar{6}' \ 0,0,z; 0,0,0 \\ (\bar{6}_z^{-1}|0,0,0)'$$

$$(6) \bar{6}'^+ \ 0,0,z; 0,0,0 \\ (\bar{6}_z|0,0,0)'$$

Generators selected (1); $t(0,0,1)$; (2); (4)

Positions

Multiplicity, Wyckoff letter, Site symmetry	Coordinates		
	(1) x,y,z [u,v,w]	(2) $\bar{y},x-y,z$ [$\bar{v},u-v,w$]	(3) $\bar{x}+y,\bar{x},z$ [$\bar{u}+v,\bar{u},w$]
6 f 1	(4) x,y,\bar{z} [u,v,\bar{w}]	(5) $\bar{y},x-y,\bar{z}$ [$\bar{v},u-v,\bar{w}$]	(6) $\bar{x}+y,\bar{x},\bar{z}$ [$\bar{u}+v,\bar{u},\bar{w}$]
3 e $m'..$	$x,y,1/2$ [$u,v,0$]	$\bar{y},x-y,1/2$ [$\bar{v},u-v,0$]	$\bar{x}+y,\bar{x},1/2$ [$\bar{u}+v,\bar{u},0$]
3 d $m'..$	$x,y,0$ [$u,v,0$]	$\bar{y},x-y,0$ [$\bar{v},u-v,0$]	$\bar{x}+y,\bar{x},0$ [$\bar{u}+v,\bar{u},0$]
2 c 3..	$0,0,z$ [$0,0,w$]	$0,0,\bar{z}$ [$0,0,\bar{w}$]	
1 b $\bar{6}^1..$	$0,0,1/2$ [$0,0,0$]		
1 a $\bar{6}^1..$	$0,0,0$ [$0,0,0$]		

Symmetry of special projections

Along [001] 3	Along [100] $p1m'1$ $a^* = c$	Along [210] $p1m'1$ $a^* = c$
Origin at $0,0,z$	Origin at $x,0,0$	Origin at $x,x/2,0$

$\rho_{2c}\bar{6}$

No. 59.4.298

 $\bar{6}1'$ $\rho_{2c}\bar{6}$

Hexagonal

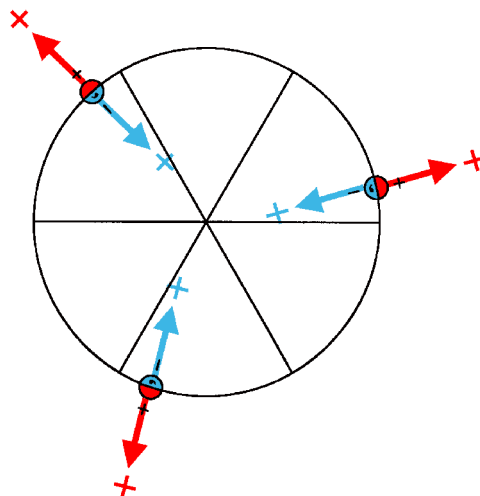
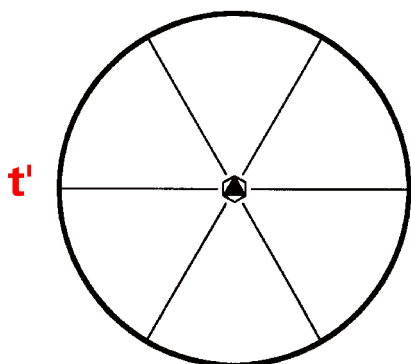
Origin at $\bar{6}$ Asymmetric unit $0 \leq x; 0 \leq y; 0 \leq z \leq 1/2$

Symmetry operations

For $(0,0,0)$ + set

(1) 1
(1|0,0,0)

(2) 3^+ 0,0,z
(3_z |0,0,0)

(3) 3^- 0,0,z
(3_z^{-1} |0,0,0)

(4) m x,y,0
(m_z |0,0,0)

(5) $\bar{6}^-$ 0,0,z; 0,0,0
($\bar{6}_z^{-1}$ |0,0,0)

(6) $\bar{6}^+$ 0,0,z; 0,0,0
($\bar{6}_z$ |0,0,0)

For $(0,0,1)'$ + set

(1) t' (0,0,1)
(1|0,0,1)'

(2) $3^{+'}$ (0,0,1) 0,0,z
(3_z |0,0,1)'

(3) $3^{-'}$ (0,0,1) 0,0,z
(3_z^{-1} |0,0,1)'

(4) m' x,y,1/2
(m_z |0,0,1)'

(5) $\bar{6}^{-'}$ 0,0,z; 0,0,1/2
($\bar{6}_z^{-1}$ |0,0,1)'

(6) $\bar{6}^{+'}$ 0,0,z; 0,0,1/2
($\bar{6}_z$ |0,0,1)'

Generators selected (1); $t(0,0,1)'$; (2); (4)

Positions

Multiplicity, Wyckoff letter, Site symmetry	Coordinates		
		(0,0,0)+	(0,0,1)' +
6 f 1	(1) x,y,z [u,v,w]	(2) $\bar{y},x-y,z$ [$\bar{v},u-v,w$]	(3) $\bar{x}+y,\bar{x},z$ [$\bar{u}+v,\bar{u},w$]
	(4) x,y, \bar{z} [\bar{u},\bar{v},w]	(5) $\bar{y},x-y,\bar{z}$ [$v,\bar{u}+v,w$]	(6) $\bar{x}+y,\bar{x},\bar{z}$ [$u-v,u,w$]
3 e m..	x,y,1/2 [0,0,w]	$\bar{y},x-y,1/2$ [0,0,w]	$\bar{x}+y,\bar{x},1/2$ [0,0,w]
3 d m..	x,y,0 [0,0,w]	$\bar{y},x-y,0$ [0,0,w]	$\bar{x}+y,\bar{x},0$ [0,0,w]
2 c 3..	0,0,z [0,0,w]	0,0, \bar{z} [0,0,w]	
1 b $\bar{6}$..	0,0,1/2 [0,0,w]		
1 a $\bar{6}$..	0,0,0 [0,0,w]		

Symmetry of special projections

Along [001] $31'$	Along [100] $\rho_{2a^*} 1m1$ $a^* = c$	Along [210] $\rho_{2a^*} 1m1$ $a^* = c$
Origin at 0,0,z	Origin at x,0,0	Origin at x,x/2,0

$p6/m$

$6/m$

Hexagonal

No. 60.1.299

$p6/m$

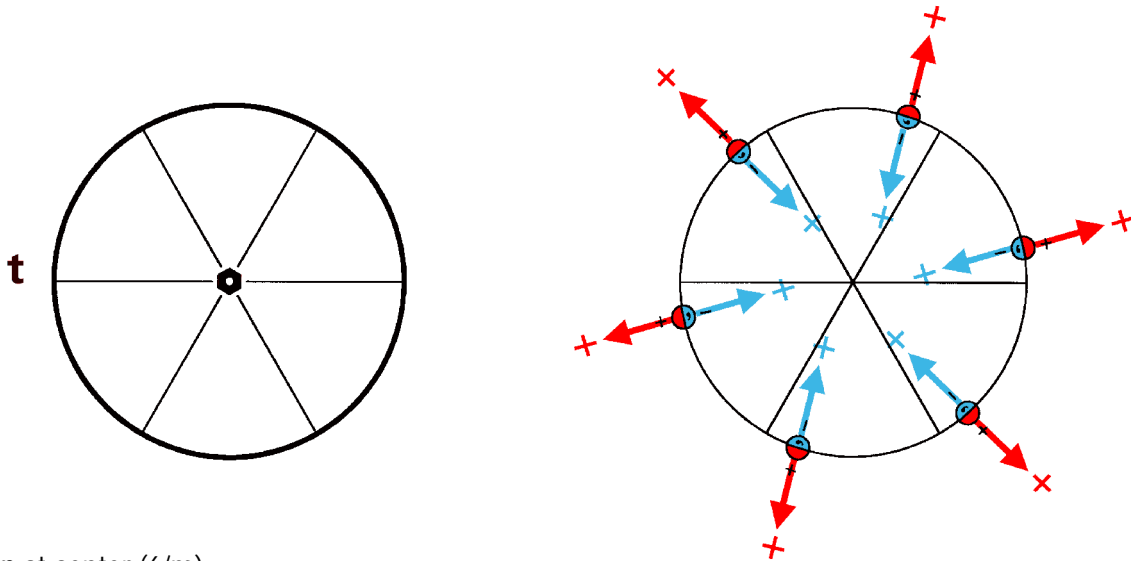

Origin at center ($6/m$)

Asymmetric unit $0 \leq x$; $0 \leq y$; $0 \leq z \leq 1/2$; $y \leq x$

Symmetry operations

- | | | |
|--|---|--|
| (1) 1
(1 0,0,0) | (2) 3^+ 0,0,z
(3_z 0,0,0) | (3) 3^- 0,0,z
(3_z^{-1} 0,0,0) |
| (4) 2 0,0,z
(2_z 0,0,0) | (5) 6^- 0,0,z
(6_z^{-1} 0,0,0) | (6) 6^+ 0,0,z
(6_z 0,0,0) |
| (7) $\bar{1}$ 0,0,0
($\bar{1}$ 0,0,0) | (8) $\bar{3}^+$ 0,0,z; 0,0,0
($\bar{3}_z$ 0,0,0) | (9) $\bar{3}^-$ 0,0,z; 0,0,0
($\bar{3}_z^{-1}$ 0,0,0) |
| (10) m x,y,0
(m_z 0,0,0) | (11) $\bar{6}^-$ 0,0,z; 0,0,0
($\bar{6}_z^{-1}$ 0,0,0) | (12) $\bar{6}^+$ 0,0,z; 0,0,0
($\bar{6}_z$ 0,0,0) |

Generators selected (1); t(0,0,1); (2); (4); (7)

Positions

	Coordinates		
Multiplicity, Wyckoff letter, Site symmetry			
12 f 1	(1) x,y,z [u,v,w]	(2) $\bar{y},x-y,z$ [$\bar{v},u-v,w$]	(3) $\bar{x}+y,\bar{x},z$ [$\bar{u}+v,\bar{u},w$]
	(4) \bar{x},\bar{y},z [\bar{u},\bar{v},w]	(5) $y,\bar{x}+y,z$ [$v,\bar{u}+v,w$]	(6) x-y,x,z [u-v,u,w]
	(7) \bar{x},\bar{y},\bar{z} [u,v,w]	(8) $y,\bar{x}+y,\bar{z}$ [$\bar{v},u-v,w$]	(9) x-y,x, \bar{z} [$\bar{u}+v,\bar{u},w$]
	(10) x,y, \bar{z} [\bar{u},\bar{v},w]	(11) $\bar{y},x-y,\bar{z}$ [$v,\bar{u}+v,w$]	(12) $\bar{x}+y,\bar{x},\bar{z}$ [u-v,u,w]
6 e m..	x,y,1/2 [0,0,w]	$\bar{y},x-y,1/2$ [0,0,w]	$\bar{x}+y,\bar{x},1/2$ [0,0,w]
	$\bar{x},\bar{y},1/2$ [0,0,w]	y, $\bar{x}+y,1/2$ [0,0,w]	x-y,x,1/2 [0,0,w]
6 d m..	x,y,0 [0,0,w]	$\bar{y},x-y,0$ [0,0,w]	$\bar{x}+y,\bar{x},0$ [0,0,w]
	$\bar{x},\bar{y},0$ [0,0,w]	y, $\bar{x}+y,0$ [0,0,w]	x-y,x,0 [0,0,w]
2 c 6..	0,0,z [0,0,w]	0,0, \bar{z} [0,0,w]	
1 b 6/m..	0,0,1/2 [0,0,w]		
1 a 6/m..	0,0,0 [0,0,w]		

Symmetry of special projections

Along [001] 6	Along [100] $p2'mm'$ $\mathbf{a}^* = \mathbf{c}$	Along [210] $p2'mm'$ $\mathbf{a}^* = \mathbf{c}$
Origin at 0,0,z	Origin at x,0,0	Origin at x,x/2,0

$p6/m1'$

$6/m1'$

Hexagonal

No. 60.2.300

$p6/m1'$

1'

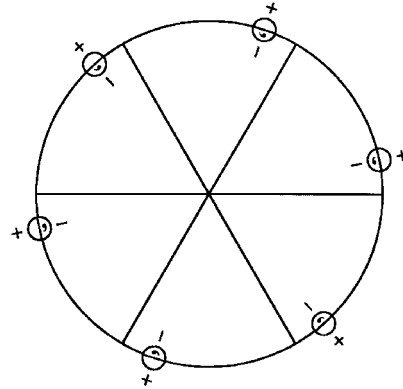
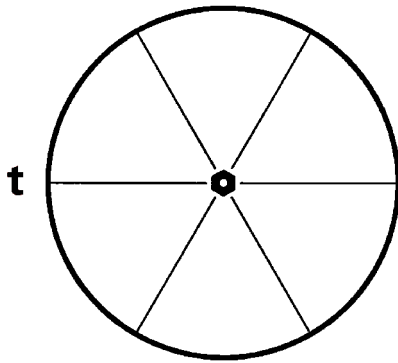

Origin at center ($6/m1'$)

Asymmetric unit $0 \leq x; 0 \leq y; 0 \leq z \leq 1/2; y \leq x$

Symmetry operations

For 1 + set

- | | | |
|--|---|--|
| (1) 1
(1 0,0,0) | (2) 3^+ 0,0,z
(3_z 0,0,0) | (3) 3^- 0,0,z
(3_z^{-1} 0,0,0) |
| (4) 2 0,0,z
(2_z 0,0,0) | (5) 6^- 0,0,z
(6_z^{-1} 0,0,0) | (6) 6^+ 0,0,z
(6_z 0,0,0) |
| (7) $\bar{1}$ 0,0,0
($\bar{1}$ 0,0,0) | (8) $\bar{3}^+$ 0,0,z; 0,0,0
($\bar{3}_z$ 0,0,0) | (9) $\bar{3}^-$ 0,0,z; 0,0,0
($\bar{3}_z^{-1}$ 0,0,0) |
| (10) m x,y,0
(m_z 0,0,0) | (11) $\bar{6}^-$ 0,0,z; 0,0,0
($\bar{6}_z^{-1}$ 0,0,0) | (12) $\bar{6}^+$ 0,0,z; 0,0,0
($\bar{6}_z$ 0,0,0) |

For 1' + set

- | | | |
|--|---|--|
| (1) 1'
(1 0,0,0)' | (2) $3^{+'}$ 0,0,z
(3_z 0,0,0)' | (3) $3^{-'}$ 0,0,z
(3_z^{-1} 0,0,0)' |
| (4) 2' 0,0,z
(2_z 0,0,0)' | (5) $6^{-'}$ 0,0,z
(6_z^{-1} 0,0,0)' | (6) $6^{+'}$ 0,0,z
(6_z 0,0,0)' |
| (7) $\bar{1}'$ 0,0,0
($\bar{1}$ 0,0,0)' | (8) $\bar{3}^{+'}$ 0,0,z; 0,0,0
($\bar{3}_z$ 0,0,0)' | (9) $\bar{3}^{-'}$ 0,0,z; 0,0,0
($\bar{3}_z^{-1}$ 0,0,0)' |
| (10) m' x,y,0
(m_z 0,0,0)' | (11) $\bar{6}^{-'}$ 0,0,z; 0,0,0
($\bar{6}_z^{-1}$ 0,0,0)' | (12) $\bar{6}^{+'}$ 0,0,z; 0,0,0
($\bar{6}_z$ 0,0,0)' |

Generators selected (1); $t(0,0,1)$; (2); (4); (7); $1'$

Positions

Multiplicity, Wyckoff letter, Site symmetry	Coordinates		
	$1+$	$1' +$	
12 f $11'$	(1) $x,y,z [0,0,0]$ (4) $\bar{x},\bar{y},z [0,0,0]$ (7) $\bar{x},\bar{y},\bar{z} [0,0,0]$ (10) $x,y,\bar{z} [0,0,0]$	(2) $\bar{y},x-y,z [0,0,0]$ (5) $y,\bar{x}+y,z [0,0,0]$ (8) $y,\bar{x}+y,\bar{z} [0,0,0]$ (11) $\bar{y},x-y,\bar{z} [0,0,0]$	(3) $\bar{x}+y,\bar{x},z [0,0,0]$ (6) $x-y,x,z [0,0,0]$ (9) $x-y,x,\bar{z} [0,0,0]$ (12) $\bar{x}+y,\bar{x},\bar{z} [0,0,0]$
6 e $m..1'$	$x,y,1/2 [0,0,0]$ $\bar{x},\bar{y},1/2 [0,0,0]$	$\bar{y},x-y,1/2 [0,0,0]$ $y,\bar{x}+y,1/2 [0,0,0]$	$\bar{x}+y,\bar{x},1/2 [0,0,0]$ $x-y,x,1/2 [0,0,0]$
6 d $m..1'$	$x,y,0 [0,0,0]$ $\bar{x},\bar{y},0 [0,0,0]$	$\bar{y},x-y,0 [0,0,0]$ $y,\bar{x}+y,0 [0,0,0]$	$\bar{x}+y,\bar{x},0 [0,0,0]$ $x-y,x,0 [0,0,0]$
2 c $6..1'$	$0,0,z [0,0,0]$	$0,0,\bar{z} [0,0,0]$	
1 b $6/m..1'$	$0,0,1/2 [0,0,0]$		
1 a $6/m..1'$	$0,0,0 [0,0,0]$		

Symmetry of special projections

Along [001] $61'$	Along [100] $p2mm1'$	Along [210] $p2mm1'$
Origin at $0,0,z$	$\mathbf{a}^* = \mathbf{c}$ Origin at $x,0,0$	$\mathbf{a}^* = \mathbf{c}$ Origin at $x,x/2,0$

$p6/m'$

$6/m'$

Hexagonal

No. 60.3.301

$p6/m'$

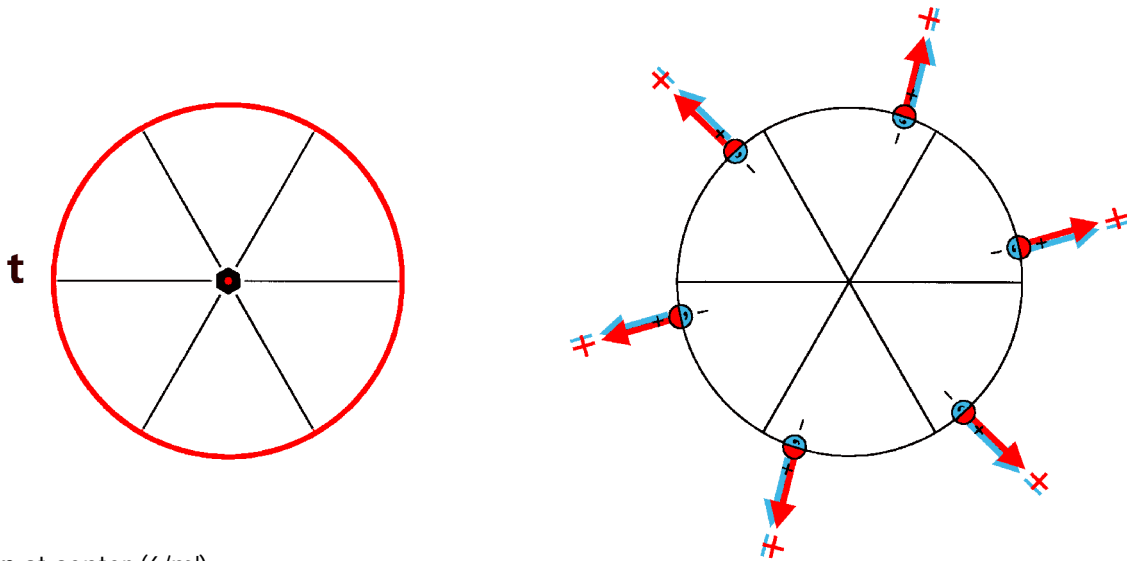

Origin at center ($6/m'$)

Asymmetric unit $0 \leq x$; $0 \leq y$; $0 \leq z \leq 1/2$; $y \leq x$

Symmetry operations

- | | | |
|---|--|---|
| (1) 1
(1 0,0,0) | (2) 3^+ 0,0,z
(3_z 0,0,0) | (3) 3^- 0,0,z
(3_z^{-1} 0,0,0) |
| (4) 2 0,0,z
(2_z 0,0,0) | (5) 6^- 0,0,z
(6_z^{-1} 0,0,0) | (6) 6^+ 0,0,z
(6_z 0,0,0) |
| (7) $\bar{1}$ 0,0,0
($\bar{1}$ 0,0,0)' | (8) $\bar{3}^+$ 0,0,z; 0,0,0
($\bar{3}_z$ 0,0,0)' | (9) $\bar{3}^-$ 0,0,z; 0,0,0
($\bar{3}_z^{-1}$ 0,0,0)' |
| (10) m' x,y,0
(m_z 0,0,0)' | (11) $\bar{6}^-$ 0,0,z; 0,0,0
($\bar{6}_z^{-1}$ 0,0,0)' | (12) $\bar{6}^+$ 0,0,z; 0,0,0
($\bar{6}_z$ 0,0,0)' |

Generators selected (1); $t(0,0,1)$; (2); (4); (7)

Positions

	Coordinates		
Multiplicity, Wyckoff letter, Site symmetry			
12 f 1	(1) x,y,z [u,v,w]	(2) $\bar{y},x-y,z$ [$\bar{v},u-v,w$]	(3) $\bar{x}+y,\bar{x},z$ [$\bar{u}+v,\bar{u},w$]
	(4) \bar{x},\bar{y},z [\bar{u},\bar{v},w]	(5) $y,\bar{x}+y,z$ [$v,\bar{u}+v,w$]	(6) $x-y,x,z$ [u-v,u,w]
	(7) \bar{x},\bar{y},\bar{z} [\bar{u},\bar{v},\bar{w}]	(8) $y,\bar{x}+y,\bar{z}$ [$v,\bar{u}+v,\bar{w}$]	(9) $x-y,x,\bar{z}$ [u-v,u, \bar{w}]
	(10) x,y,\bar{z} [u,v, \bar{w}]	(11) $\bar{y},x-y,\bar{z}$ [$\bar{v},u-v,\bar{w}$]	(12) $\bar{x}+y,\bar{x},\bar{z}$ [$\bar{u}+v,\bar{u},\bar{w}$]
6 e m' ..	$x,y,1/2$ [u,v,0]	$\bar{y},x-y,1/2$ [$\bar{v},u-v,0$]	$\bar{x}+y,\bar{x},1/2$ [$\bar{u}+v,\bar{u},0$]
	$\bar{x},\bar{y},1/2$ [$\bar{u},\bar{v},0$]	$y,\bar{x}+y,1/2$ [$v,\bar{u}+v,0$]	$x-y,x,1/2$ [u-v,u,0]
6 d m' ..	$x,y,0$ [u,v,0]	$\bar{y},x-y,0$ [$\bar{v},u-v,0$]	$\bar{x}+y,\bar{x},0$ [$\bar{u}+v,\bar{u},0$]
	$\bar{x},\bar{y},0$ [$\bar{u},\bar{v},0$]	$y,\bar{x}+y,0$ [$v,\bar{u}+v,0$]	$x-y,x,0$ [u-v,u,0]
2 c 6..	$0,0,z$ [0,0,w]	$0,0,\bar{z}$ [0,0, \bar{w}]	
1 b $6/m'$..	$0,0,1/2$ [0,0,0]		
1 a $6/m'$..	$0,0,0$ [0,0,0]		

Symmetry of special projections

Along [001] $61'$	Along [100] $p2m'm'$	Along [210] $p2m'm'$
Origin at 0,0,z	$\mathbf{a}^* = \mathbf{c}$ Origin at x,0,0	$\mathbf{a}^* = \mathbf{c}$ Origin at x,x/2,0

$p6'/m'$

No. 60.4.302

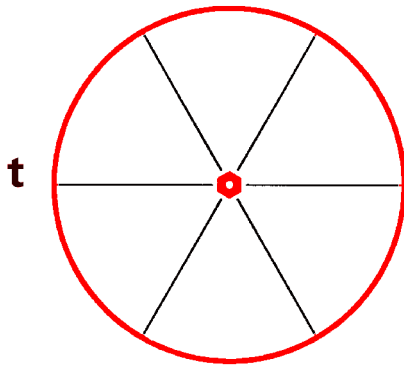

$6'/m'$

$p6'/m'$

Hexagonal

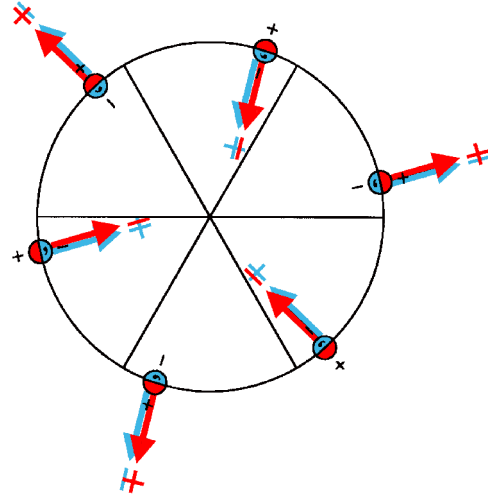

Origin at center ($6'/m'$)

Asymmetric unit $0 \leq x$; $0 \leq y$; $0 \leq z \leq 1/2$; $y \leq x$

Symmetry operations

- | | | |
|--|--|--|
| (1) 1
(1 0,0,0) | (2) 3^+ 0,0,z
(3_z 0,0,0) | (3) 3^- 0,0,z
(3_z^{-1} 0,0,0) |
| (4) $2'$ 0,0,z
(2_z 0,0,0)' | (5) 6^+ 0,0,z
(6_z^+ 0,0,0)' | (6) 6^{+} 0,0,z
(6_z 0,0,0)' |
| (7) $\bar{1}$ 0,0,0
($\bar{1}$ 0,0,0) | (8) $\bar{3}^+$ 0,0,z; 0,0,0
($\bar{3}_z$ 0,0,0) | (9) $\bar{3}^-$ 0,0,z; 0,0,0
($\bar{3}_z^{-1}$ 0,0,0) |
| (10) m' x,y,0
(m_z 0,0,0)' | (11) $\bar{6}^-$ 0,0,z; 0,0,0
($\bar{6}_z^{-1}$ 0,0,0)' | (12) $\bar{6}^{+}$ 0,0,z; 0,0,0
($\bar{6}_z$ 0,0,0)' |

Generators selected (1); $t(0,0,1)$; (2); (4); (7)

Positions

	Coordinates		
Multiplicity, Wyckoff letter, Site symmetry			
12 f 1	(1) x,y,z [u,v,w]	(2) $\bar{y},x-y,z$ [$\bar{v},u-v,w$]	(3) $\bar{x}+y,\bar{x},z$ [$\bar{u}+v,\bar{u},w$]
	(4) \bar{x},\bar{y},z [u,v, \bar{w}]	(5) $y,\bar{x}+y,z$ [$\bar{v},u-v,\bar{w}$]	(6) $x-y,x,z$ [$\bar{u}+v,\bar{u},\bar{w}$]
	(7) \bar{x},\bar{y},\bar{z} [u,v,w]	(8) $y,\bar{x}+y,\bar{z}$ [$\bar{v},u-v,w$]	(9) $x-y,x,\bar{z}$ [$\bar{u}+v,\bar{u},w$]
	(10) x,y,\bar{z} [u,v, \bar{w}]	(11) $\bar{y},x-y,\bar{z}$ [$\bar{v},u-v,\bar{w}$]	(12) $\bar{x}+y,\bar{x},\bar{z}$ [$\bar{u}+v,\bar{u},\bar{w}$]
6 e $m'..$	$x,y,1/2$ [u,v,0]	$\bar{y},x-y,1/2$ [$\bar{v},u-v,0$]	$\bar{x}+y,\bar{x},1/2$ [$\bar{u}+v,\bar{u},0$]
	$\bar{x},\bar{y},1/2$ [u,v,0]	$y,\bar{x}+y,1/2$ [$\bar{v},u-v,0$]	$x-y,x,1/2$ [$\bar{u}+v,\bar{u},0$]
6 d $m'..$	$x,y,0$ [u,v,0]	$\bar{y},x-y,0$ [$\bar{v},u-v,0$]	$\bar{x}+y,\bar{x},0$ [$\bar{u}+v,\bar{u},0$]
	$\bar{x},\bar{y},0$ [u,v,0]	$y,\bar{x}+y,0$ [$\bar{v},u-v,0$]	$x-y,x,0$ [$\bar{u}+v,\bar{u},0$]
2 c $6'..$	$0,0,z$ [0,0,0]	$0,0,\bar{z}$ [0,0,0]	
1 b $6'/m'..$	$0,0,1/2$ [0,0,0]		
1 a $6'/m'..$	$0,0,0$ [0,0,0]		

Symmetry of special projections

Along [001] $61'$	Along [100] $\rho 2'm'm$ $\mathbf{a}^* = \mathbf{c}$	Along [210] $\rho 2'm'm$ $\mathbf{a}^* = \mathbf{c}$
Origin at 0,0,z	Origin at x,0,0	Origin at x,x/2,0

$p6'/m$

No. 60.5.303

$6'/m$

$p6'/m$

Hexagonal

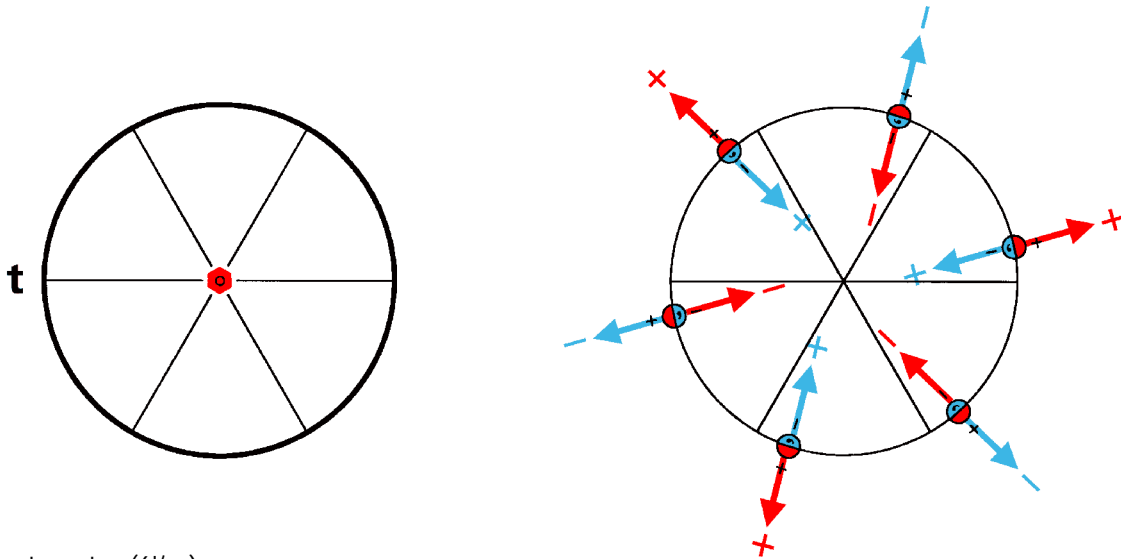

Origin at center ($6'/m$)

Asymmetric unit $0 \leq x$; $0 \leq y$; $0 \leq z \leq 1/2$; $y \leq x$

Symmetry operations

- | | | |
|---|---|---|
| (1) 1
(1 0,0,0) | (2) 3^+ 0,0,z
(3_z 0,0,0) | (3) 3^- 0,0,z
(3_z^{-1} 0,0,0) |
| (4) $2'$ 0,0,z
(2_z 0,0,0)' | (5) 6^- 0,0,z
(6_z^{-1} 0,0,0)' | (6) 6^+ 0,0,z
(6_z 0,0,0)' |
| (7) $\bar{1}$ 0,0,0
($\bar{1}$ 0,0,0)' | (8) $\bar{3}^+$ 0,0,z; 0,0,0
($\bar{3}_z$ 0,0,0)' | (9) $\bar{3}^-$ 0,0,z; 0,0,0
($\bar{3}_z^{-1}$ 0,0,0)' |
| (10) m x,y,0
(m_z 0,0,0) | (11) $\bar{6}^-$ 0,0,z; 0,0,0
($\bar{6}_z^{-1}$ 0,0,0) | (12) $\bar{6}^+$ 0,0,z; 0,0,0
($\bar{6}_z$ 0,0,0) |

Generators selected (1); $t(0,0,1)$; (2); (4); (7)

Positions

	Coordinates		
Multiplicity, Wyckoff letter, Site symmetry			
12 f 1	(1) x,y,z [u,v,w]	(2) $\bar{y},x-y,z$ [$\bar{v},u-v,w$]	(3) $\bar{x}+y,\bar{x},z$ [$\bar{u}+v,\bar{u},w$]
	(4) \bar{x},\bar{y},z [u,v,\bar{w}]	(5) $y,\bar{x}+y,z$ [$\bar{v},u-v,\bar{w}$]	(6) $x-y,x,z$ [$\bar{u}+v,\bar{u},\bar{w}$]
	(7) \bar{x},\bar{y},\bar{z} [\bar{u},\bar{v},\bar{w}]	(8) $y,\bar{x}+y,\bar{z}$ [$v,\bar{u}+v,\bar{w}$]	(9) $x-y,x,\bar{z}$ [$u-v,u,\bar{w}$]
	(10) x,y,\bar{z} [\bar{v},\bar{u},w]	(11) $\bar{y},x-y,\bar{z}$ [$v,\bar{u}+v,w$]	(12) $\bar{x}+y,\bar{x},\bar{z}$ [$u-v,u,w$]
6 e m..	$x,y,1/2$ [$0,0,w$]	$\bar{y},x-y,1/2$ [$0,0,w$]	$\bar{x}+y,\bar{x},1/2$ [$0,0,w$]
	$\bar{x},\bar{y},1/2$ [$0,0,\bar{w}$]	$y,\bar{x}+y,1/2$ [$0,0,\bar{w}$]	$x-y,x,1/2$ [$0,0,\bar{w}$]
6 d m..	$x,y,0$ [$0,0,w$]	$\bar{y},x-y,0$ [$0,0,w$]	$\bar{x}+y,\bar{x},0$ [$0,0,w$]
	$\bar{x},\bar{y},0$ [$0,0,\bar{w}$]	$y,\bar{x}+y,0$ [$0,0,\bar{w}$]	$x-y,x,0$ [$0,0,\bar{w}$]
2 c 6'..	$0,0,z$ [$0,0,0$]	$0,0,\bar{z}$ [$0,0,0$]	
1 b 6'/m..	$0,0,1/2$ [$0,0,0$]		
1 a 6'/m..	$0,0,0$ [$0,0,0$]		

Symmetry of special projections

Along [001] 6'	Along [100] $p2mm$ $\mathbf{a}^* = \mathbf{c}$	Along [210] $p2mm$ $\mathbf{a}^* = \mathbf{c}$
Origin at $0,0,z$	Origin at $x,0,0$	Origin at $x,x/2,0$

$\rho_{2c} 6'/m'$

$6/m1'$

Hexagonal

No. 60.6.304

$\rho_{2c} 6'/m'$

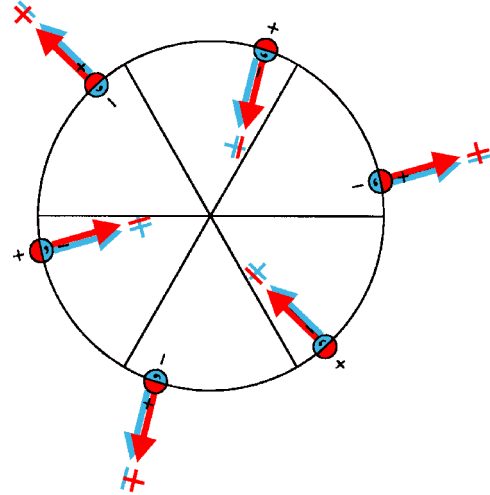
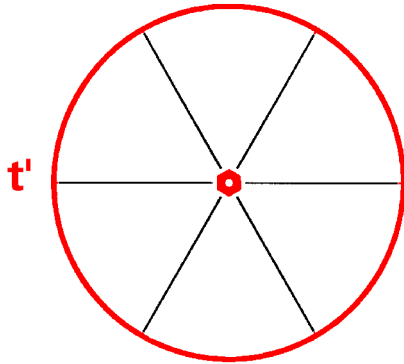

Origin at center ($6'/m'$)

Asymmetric unit $0 \leq x; 0 \leq y; 0 \leq z \leq 1/2; y \leq x$

Symmetry operations

For (0,0,0) + set

- | | | |
|--|--|--|
| (1) 1
(1 0,0,0) | (2) 3^+ 0,0,z
(3_z 0,0,0) | (3) 3^- 0,0,z
(3_z^{-1} 0,0,0) |
| (4) $2'$ 0,0,z
(2_z 0,0,0)' | (5) 6^- 0,0,z
(6_z^{-1} 0,0,0)' | (6) 6^+ 0,0,z
(6_z 0,0,0)' |
| (7) $\bar{1}$ 0,0,0
($\bar{1}$ 0,0,0) | (8) $\bar{3}^+$ 0,0,z; 0,0,0
($\bar{3}_z$ 0,0,0) | (9) $\bar{3}^-$ 0,0,z; 0,0,0
($\bar{3}_z^{-1}$ 0,0,0) |
| (10) m' x,y,0
(m_z 0,0,0)' | (11) $\bar{6}^-$ 0,0,z; 0,0,0
($\bar{6}_z^{-1}$ 0,0,0)' | (12) $\bar{6}^+$ 0,0,z; 0,0,0
($\bar{6}_z$ 0,0,0)' |

For (0,0,1)' + set

- | | | |
|--|--|--|
| (1) t' (0,0,1)
(1 0,0,1)' | (2) $3^{+'}$ (0,0,1) 0,0,z
(3_z 0,0,1)' | (3) $3^{-'}$ (0,0,1) 0,0,z
(3_z^{-1} 0,0,1)' |
| (4) $2'$ (0,0,1) 0,0,z
(2_z 0,0,1) | (5) $6^{-'}$ (0,0,1) 0,0,z
(6_z^{-1} 0,0,1) | (6) $6^{+'}$ (0,0,1) 0,0,z
(6_z 0,0,1) |
| (7) $\bar{1}'$ 0,0,1/2
($\bar{1}$ 0,0,1)' | (8) $\bar{3}^{+'}$ 0,0,z; 0,0,1/2
($\bar{3}_z$ 0,0,1)' | (9) $\bar{3}^{-'}$ 0,0,z; 0,0,1/2
($\bar{3}_z^{-1}$ 0,0,1)' |
| (10) m' x,y,1/2
(m_z 0,0,1) | (11) $\bar{6}^{-'}$ 0,0,z; 0,0,1/2
($\bar{6}_z^{-1}$ 0,0,1) | (12) $\bar{6}^{+'}$ 0,0,z; 0,0,1/2
($\bar{6}_z$ 0,0,1) |

Generators selected (1); $t(0,0,1)'$; (2); (4); (7)

Positions

Multiplicity, Wyckoff letter, Site symmetry	Coordinates		
		(0,0,0)+	(0,0,1)' +
12 f 1	(1) $x,y,z [u,v,w]$	(2) $\bar{y},x-y,z [\bar{v},u-v,w]$	(3) $\bar{x}+y,\bar{x},z [\bar{u}+v,\bar{u},w]$
	(4) $\bar{x},\bar{y},z [u,v,\bar{w}]$	(5) $y,\bar{x}+y,z [\bar{v},u-v,\bar{w}]$	(6) $x-y,x,z [\bar{u}+v,\bar{u},\bar{w}]$
	(7) $\bar{x},\bar{y},\bar{z} [u,v,w]$	(8) $y,\bar{x}+y,\bar{z} [\bar{v},u-v,w]$	(9) $x-y,x,\bar{z} [\bar{u}+v,\bar{u},w]$
	(10) $x,y,\bar{z} [u,v,\bar{w}]$	(11) $\bar{y},x-y,\bar{z} [\bar{v},u-v,\bar{w}]$	(12) $\bar{x}+y,\bar{x},\bar{z} [\bar{u}+v,\bar{u},\bar{w}]$
6 e m..	$x,y,1/2 [0,0,w]$	$\bar{y},x-y,1/2 [0,0,w]$	$\bar{x}+y,\bar{x},1/2 [0,0,w]$
	$\bar{x},\bar{y},1/2 [0,0,\bar{w}]$	$y,\bar{x}+y,1/2 [0,0,\bar{w}]$	$x-y,x,1/2 [0,0,\bar{w}]$
6 d m'..	$x,y,0 [u,v,0]$	$\bar{y},x-y,0 [\bar{v},u-v,0]$	$\bar{x}+y,\bar{x},0 [\bar{u}+v,\bar{u},0]$
	$\bar{x},\bar{y},0 [u,v,0]$	$y,\bar{x}+y,0 [\bar{v},u-v,0]$	$x-y,x,0 [\bar{u}+v,\bar{u},0]$
2 c 6..	$0,0,z [0,0,0]$	$0,0,\bar{z} [0,0,0]$	
1 b 6'/m..	$0,0,1/2 [0,0,0]$		
1 a 6'/m'..	$0,0,0 [0,0,0]$		

Symmetry of special projections

Along [001] $61'$	Along [100] $p_{2a^*} 2'm'm$ $\mathbf{a}^* = \mathbf{c}$	Along [210] $p_{2a^*} 2'm'm$ $\mathbf{a}^* = \mathbf{c}$
Origin at 0,0,z	Origin at x,0,0	Origin at x,x/2,0

$p_{2c}6/m$

$6/m1'$

Hexagonal

No. 60.7.305

$p_{2c}6/m$

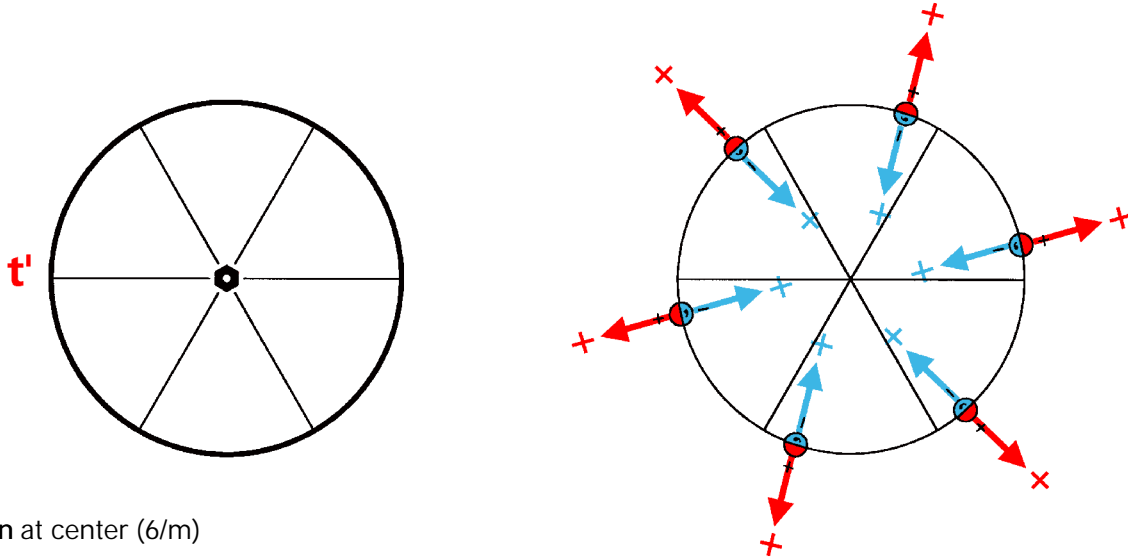

Origin at center ($6/m$)

Asymmetric unit $0 \leq x$; $0 \leq y$; $0 \leq z \leq 1/2$; $y \leq x$

Symmetry operations

For $(0,0,0)$ + set

- | | | |
|--|---|--|
| (1) 1
(1 0,0,0) | (2) 3^+ 0,0,z
(3_z 0,0,0) | (3) 3^- 0,0,z
(3_z^{-1} 0,0,0) |
| (4) 2 0,0,z
(2_z 0,0,0) | (5) 6^- 0,0,z
(6_z^{-1} 0,0,0) | (6) 6^+ 0,0,z
(6_z 0,0,0) |
| (7) $\bar{1}$ 0,0,0
($\bar{1}$ 0,0,0) | (8) $\bar{3}^+$ 0,0,z; 0,0,0
($\bar{3}_z$ 0,0,0) | (9) $\bar{3}^-$ 0,0,z; 0,0,0
($\bar{3}_z^{-1}$ 0,0,0) |
| (10) m x,y,0
(m_z 0,0,0) | (11) $\bar{6}^-$ 0,0,z; 0,0,0
($\bar{6}_z^{-1}$ 0,0,0) | (12) $\bar{6}^+$ 0,0,z; 0,0,0
($\bar{6}_z$ 0,0,0) |

For $(0,0,1)'$ + set

- | | | |
|--|---|--|
| (1) t' (0,0,1)
(1 0,0,1)' | (2) $3^{+'}$ (0,0,1) 0,0,z
(3_z 0,0,1)' | (3) $3^{-'}$ (0,0,1) 0,0,z
(3_z^{-1} 0,0,1)' |
| (4) $2'$ (0,0,1) 0,0,z
(2_z 0,0,1)' | (5) $6^{-'}$ (0,0,1) 0,0,z
(6_z^{-1} 0,0,1)' | (6) $6^{+'}$ (0,0,1) 0,0,z
(6_z 0,0,1)' |
| (7) $\bar{1}'$ 0,0,1/2
($\bar{1}$ 0,0,1)' | (8) $\bar{3}^{+'}$ 0,0,z; 0,0,1/2
($\bar{3}_z$ 0,0,1)' | (9) $\bar{3}^{-'}$ 0,0,z; 0,0,1/2
($\bar{3}_z^{-1}$ 0,0,1)' |
| (10) m' x,y,1/2
(m_z 0,0,1)' | (11) $\bar{6}^{-'}$ 0,0,z; 0,0,1/2
($\bar{6}_z^{-1}$ 0,0,1)' | (12) $\bar{6}^{+'}$ 0,0,z; 0,0,1/2
($\bar{6}_z$ 0,0,1)' |

Generators selected (1); $t(0,0,1)'$; (2); (4); (7)

Positions

Multiplicity, Wyckoff letter, Site symmetry	Coordinates		
	(0,0,0)+	(0,0,1)' +	
12 f 1	(1) $x,y,z [u,v,w]$ (4) $\bar{x},\bar{y},z [\bar{u},\bar{v},w]$ (7) $\bar{x},\bar{y},\bar{z} [u,v,w]$ (10) $x,y,\bar{z} [\bar{u},\bar{v},w]$	(2) $\bar{y},x-y,z [\bar{v},u-v,w]$ (5) $y,\bar{x}+y,z [v,\bar{u}+v,w]$ (8) $y,\bar{x}+y,\bar{z} [\bar{v},u-v,w]$ (11) $\bar{y},x-y,\bar{z} [v,\bar{u}+v,w]$	(3) $\bar{x}+y,\bar{x},z [\bar{u}+v,\bar{u},w]$ (6) $x-y,x,z [u-v,u,w]$ (9) $x-y,x,\bar{z} [\bar{u}+v,\bar{u},w]$ (12) $\bar{x}+y,\bar{x},\bar{z} [u-v,u,w]$
6 e $m'..$	$x,y,1/2 [u,v,0]$ $\bar{x},\bar{y},1/2 [\bar{u},\bar{v},0]$	$\bar{y},x-y,1/2 [\bar{v},u-v,0]$ $y,\bar{x}+y,1/2 [v,\bar{u}+v,0]$	$\bar{x}+y,\bar{x},1/2 [\bar{u}+v,\bar{u},0]$ $x-y,x,1/2 [u-v,u,0]$
6 d $m..$	$x,y,0 [0,0,w]$ $\bar{x},\bar{y},0 [0,0,w]$	$\bar{y},x-y,0 [0,0,w]$ $y,\bar{x}+y,0 [0,0,w]$	$\bar{x}+y,\bar{x},0 [0,0,w]$ $x-y,x,0 [0,0,w]$
2 c $6..$	$0,0,z [0,0,w]$	$0,0,\bar{z} [0,0,w]$	
1 b $6/m'..$	$0,0,1/2 [0,0,0]$		
1 a $6/m..$	$0,0,0 [0,0,w]$		

Symmetry of special projections

Along [001] $61'$	Along [100] $p_{2a^*} 2'mm'$ $\mathbf{a}^* = \mathbf{c}$	Along [210] $p_{2a^*} 2'mm'$ $\mathbf{a}^* = \mathbf{c}$
Origin at 0,0,z	Origin at x,0,0	Origin at x,x/2,0

$p6_3/m$

$6/m$

Hexagonal

No. 61.1.306

$p6_3/m$

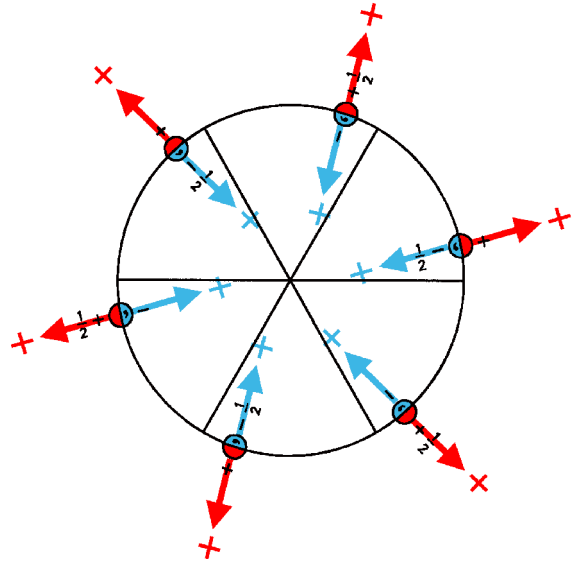
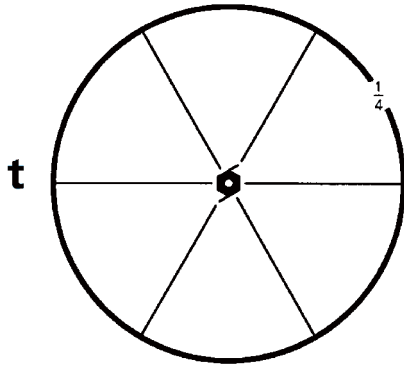

Origin at center ($\bar{3}$) on 6_3

Asymmetric unit $0 \leq x$; $0 \leq y$; $0 \leq z \leq 1/4$

Symmetry operations

- | | | |
|--|--|--|
| (1) 1
(1 0,0,0) | (2) 3^+ 0,0,z
(3_z 0,0,0) | (3) 3^- 0,0,z
(3_z^{-1} 0,0,0) |
| (4) 2 (0,0,1/2) 0,0,z
(2_z 0,0,1/2) | (5) 6^+ (0,0,1/2) 0,0,z
(6_z^+ 0,0,1/2) | (6) 6^- (0,0,1/2) 0,0,z
(6_z^- 0,0,1/2) |
| (7) $\bar{1}$ 0,0,0
($\bar{1}$ 0,0,0) | (8) $\bar{3}^+$ 0,0,z; 0,0,0
($\bar{3}_z^+$ 0,0,0) | (9) $\bar{3}^-$ 0,0,z; 0,0,0
($\bar{3}_z^-$ 0,0,0) |
| (10) m x,y,1/4
(m_z 0,0,1/2) | (11) $\bar{6}^-$ 0,0,z; 0,0,1/4
($\bar{6}_z^-$ 0,0,1/2) | (12) $\bar{6}^+$ 0,0,z; 0,0,1/4
($\bar{6}_z^+$ 0,0,1/2) |

Generators selected (1); $t(0,0,1)$; (2); (4); (7)

Positions

	Coordinates		
Multiplicity, Wyckoff letter, Site symmetry			
12 e 1	(1) x,y,z [u,v,w]	(2) $\bar{y},x-y,z$ [$\bar{v},u-v,w$]	(3) $\bar{x}+y,\bar{x},z$ [$\bar{u}+v,\bar{u},w$]
	(4) $\bar{x},\bar{y},z+1/2$ [\bar{u},\bar{v},w]	(5) $y,\bar{x}+y,z+1/2$ [$v,\bar{u}+v,w$]	(6) $x-y,x,z+1/2$ [$u-v,u,w$]
	(7) \bar{x},\bar{y},\bar{z} [u,v,w]	(8) $y,\bar{x}+y,\bar{z}$ [$\bar{v},u-v,w$]	(9) $x-y,x,\bar{z}$ [$\bar{u}+v,\bar{u},w$]
	(10) $x,y,\bar{z}+1/2$ [\bar{u},\bar{v},w]	(11) $\bar{y},x-y,\bar{z}+1/2$ [$v,\bar{u}+v,w$]	(12) $\bar{x}+y,\bar{x},\bar{z}+1/2$ [$u-v,u,w$]
6 d m..	$x,y,1/4$ [0,0,w]	$\bar{y},x-y,1/4$ [0,0,w]	$\bar{x}+y,\bar{x},1/4$ [0,0,w]
	$\bar{x},\bar{y},3/4$ [0,0,w]	$y,\bar{x}+y,3/4$ [0,0,w]	$x-y,x,3/4$ [0,0,w]
4 c 3..	$0,0,z$ [0,0,w]	$0,0,z+1/2$ [0,0,w]	
	$0,0,\bar{z}$ [0,0,w]	$0,0,\bar{z}+1/2$ [0,0,w]	
2 b $\bar{3}$..	$0,0,0$ [0,0,w]	$0,0,1/2$ [0,0,w]	
2 a $\bar{6}$..	$0,0,1/4$ [0,0,w]	$0,0,3/4$ [0,0,w]	

Symmetry of special projections

Along [001] 6	Along [100] $\rho 2'mg'$ $\mathbf{a}^* = \mathbf{c}$	Along [210] $\rho 2'mg'$ $\mathbf{a}^* = \mathbf{c}$
Origin at 0,0,z	Origin at x,0,0	Origin at x,x/2,0

$p6_3/m1'$

$6/m1'$

Hexagonal

No. 61.2.307

$p6_3/m1'$

1'

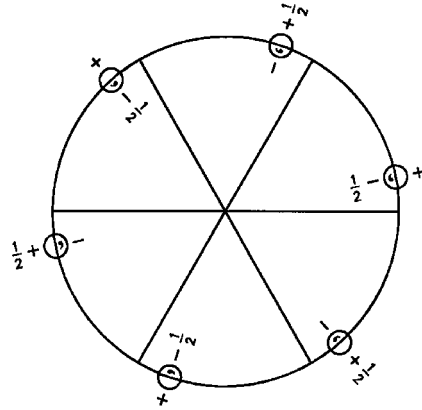
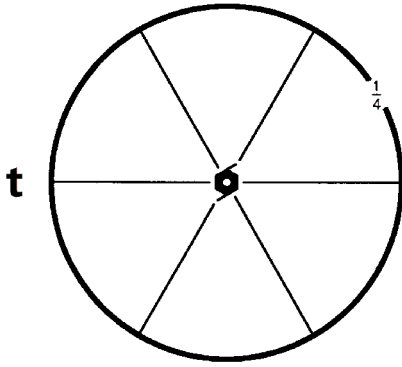

Origin at center ($\bar{3}1'$) on $6_31'$

Asymmetric unit $0 \leq x; 0 \leq y; 0 \leq z \leq 1/4$

Symmetry operations

For 1 + set

- | | | |
|--|---|--|
| (1) 1
(1 0,0,0) | (2) 3^+ 0,0,z
(3_z 0,0,0) | (3) 3^- 0,0,z
(3_z^{-1} 0,0,0) |
| (4) 2 (0,0,1/2) 0,0,z
(2_z 0,0,1/2) | (5) 6^- (0,0,1/2) 0,0,z
(6_z^{-1} 0,0,1/2) | (6) 6^+ (0,0,1/2) 0,0,z
(6_z 0,0,1/2) |
| (7) $\bar{1}$ 0,0,0
($\bar{1}$ 0,0,0) | (8) $\bar{3}^+$ 0,0,z; 0,0,0
($\bar{3}_z$ 0,0,0) | (9) $\bar{3}^-$ 0,0,z; 0,0,0
($\bar{3}_z^{-1}$ 0,0,0) |
| (10) m x,y,1/4
(m_z 0,0,1/2) | (11) $\bar{6}^-$ 0,0,z; 0,0,1/4
($\bar{6}_z^{-1}$ 0,0,1/2) | (12) $\bar{6}^+$ 0,0,z; 0,0,1/4
($\bar{6}_z$ 0,0,1/2) |

For 1' + set

- | | | |
|--|---|--|
| (1) 1'
(1 0,0,0)' | (2) $3^{+'}$ 0,0,z
(3_z 0,0,0)' | (3) $3^{-'}$ 0,0,z
(3_z^{-1} 0,0,0)' |
| (4) 2' (0,0,1/2) 0,0,z
(2_z 0,0,1/2)' | (5) $6^{-'}$ (0,0,1/2) 0,0,z
(6_z^{-1} 0,0,1/2)' | (6) $6^{+'}$ (0,0,1/2) 0,0,z
(6_z 0,0,1/2)' |
| (7) $\bar{1}'$ 0,0,0
($\bar{1}$ 0,0,0)' | (8) $\bar{3}^{+'}$ 0,0,z; 0,0,0
($\bar{3}_z$ 0,0,0)' | (9) $\bar{3}^{-'}$ 0,0,z; 0,0,0
($\bar{3}_z^{-1}$ 0,0,0)' |
| (10) m' x,y,1/4
(m_z 0,0,1/2)' | (11) $\bar{6}^{-'}$ 0,0,z; 0,0,1/4
($\bar{6}_z^{-1}$ 0,0,1/2)' | (12) $\bar{6}^{+'}$ 0,0,z; 0,0,1/4
($\bar{6}_z$ 0,0,1/2)' |

Generators selected (1); $t(0,0,1)$; (2); (4); (7); $1'$

Positions

Multiplicity, Wyckoff letter, Site symmetry	Coordinates		
		$1+$	$1'+$
12 e $11'$	(1) x,y,z [0,0,0] (4) $\bar{x},\bar{y},z+1/2$ [0,0,0] (7) \bar{x},\bar{y},\bar{z} [0,0,0] (10) $x,y,\bar{z}+1/2$ [0,0,0]	(2) $\bar{y},x-y,z$ [0,0,0] (5) $y,\bar{x}+y,z+1/2$ [0,0,0] (8) $y,\bar{x}+y,\bar{z}$ [0,0,0] (11) $\bar{y},x-y,\bar{z}+1/2$ [0,0,0]	(3) $\bar{x}+y,\bar{x},z$ [0,0,0] (6) $x-y,x,z+1/2$ [0,0,0] (9) $x-y,x,\bar{z}$ [0,0,0] (12) $\bar{x}+y,\bar{x},\bar{z}+1/2$ [0,0,0]
6 d $m..1'$	$x,y,1/4$ [0,0,0] $\bar{x},\bar{y},3/4$ [0,0,0]	$\bar{y},x-y,1/4$ [0,0,0] $y,\bar{x}+y,3/4$ [0,0,0]	$\bar{x}+y,\bar{x},1/4$ [0,0,0] $x-y,x,3/4$ [0,0,0]
4 c $3..1'$	$0,0,z$ [0,0,0] $0,0,\bar{z}$ [0,0,0]	$0,0,z+1/2$ [0,0,0] $0,0,\bar{z}+1/2$ [0,0,0]	
2 b $\bar{3}..1'$	$0,0,0$ [0,0,0]	$0,0,1/2$ [0,0,0]	
2 a $\bar{6}..1'$	$0,0,1/4$ [0,0,0]	$0,0,3/4$ [0,0,0]	

Symmetry of special projections

Along [001] $61'$	Along [100] $p2mg1'$	Along [210] $p2mg1'$
Origin at 0,0,z	$a^* = c$ Origin at x,0,0	$a^* = c$ Origin at x,x/2,0

$p6_3/m'$

No. 61.3.308

$6/m'$

$p6_3/m'$

Hexagonal

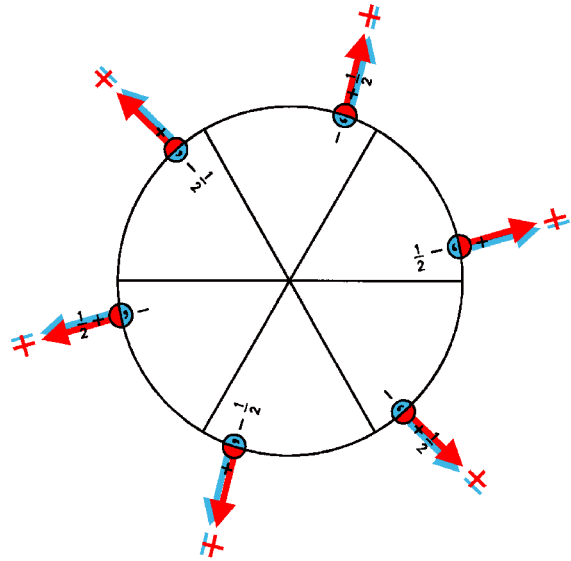
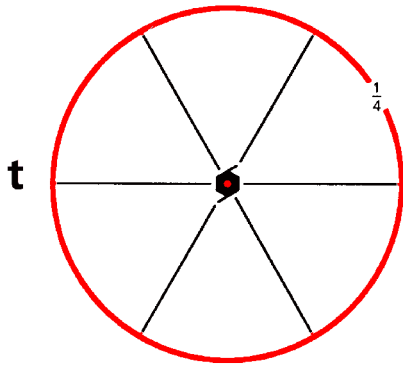

Origin at center ($\bar{3}$) on 6_3

Asymmetric unit $0 \leq x$; $0 \leq y$; $0 \leq z \leq 1/4$

Symmetry operations

- | | | |
|---|--|---|
| (1) 1
(1 0,0,0) | (2) 3^+ 0,0,z
(3_z 0,0,0) | (3) 3^- 0,0,z
(3_z^{-1} 0,0,0) |
| (4) 2 (0,0,1/2) 0,0,z
(2_z 0,0,1/2) | (5) 6^- (0,0,1/2) 0,0,z
(6_z^{-1} 0,0,1/2) | (6) 6^+ (0,0,1/2) 0,0,z
(6_z 0,0,1/2) |
| (7) $\bar{1}$ 0,0,0
($\bar{1}$ 0,0,0)' | (8) $\bar{3}^+$ 0,0,z; 0,0,0
($\bar{3}_z$ 0,0,0)' | (9) $\bar{3}^-$ 0,0,z; 0,0,0
($\bar{3}_z^{-1}$ 0,0,0)' |
| (10) m' x,y,1/4
(m_z 0,0,1/2)' | (11) $\bar{6}^-$ 0,0,z; 0,0,1/4
($\bar{6}_z^{-1}$ 0,0,1/2)' | (12) $\bar{6}^+$ 0,0,z; 0,0,1/4
($\bar{6}_z$ 0,0,1/2)' |

Generators selected (1); $t(0,0,1)$; (2); (4); (7)

Positions

	Coordinates		
Multiplicity, Wyckoff letter, Site symmetry			
12 e 1	(1) x,y,z [u,v,w]	(2) $\bar{y},x-y,z$ [$\bar{v},u-v,w$]	(3) $\bar{x}+y,\bar{x},z$ [$\bar{u}+v,\bar{u},w$]
	(4) $\bar{x},\bar{y},z+1/2$ [\bar{u},\bar{v},w]	(5) $y,\bar{x}+y,z+1/2$ [$v,\bar{u}+v,w$]	(6) $x-y,x,z+1/2$ [$u-v,u,w$]
	(7) \bar{x},\bar{y},\bar{z} [\bar{u},\bar{v},\bar{w}]	(8) $y,\bar{x}+y,\bar{z}$ [$v,\bar{u}+v,\bar{w}$]	(9) $x-y,x,\bar{z}$ [$u-v,u,\bar{w}$]
	(10) $x,y,\bar{z}+1/2$ [u,v,\bar{w}]	(11) $\bar{y},x-y,\bar{z}+1/2$ [$\bar{v},u-v,\bar{w}$]	(12) $\bar{x}+y,\bar{x},\bar{z}+1/2$ [$\bar{u}+v,\bar{u},\bar{w}$]
6 d m' ..	$x,y,1/4$ [u,v,0]	$\bar{y},x-y,1/4$ [$\bar{v},u-v,0$]	$\bar{x}+y,\bar{x},1/4$ [$\bar{u}+v,\bar{u},0$]
	$\bar{x},\bar{y},3/4$ [$\bar{u},\bar{v},0$]	$y,\bar{x}+y,3/4$ [$v,\bar{u}+v,0$]	$x-y,x,3/4$ [$u-v,u,0$]
4 c 3..	$0,0,z$ [0,0,w]	$0,0,z+1/2$ [0,0,w]	
	$0,0,\bar{z}$ [0,0, \bar{w}]	$0,0,\bar{z}+1/2$ [0,0, \bar{w}]	
2 b $\bar{3}'$..	$0,0,0$ [0,0,0]	$0,0,1/2$ [0,0,0]	
2 a $\bar{6}'$..	$0,0,1/4$ [0,0,0]	$0,0,3/4$ [0,0,0]	

Symmetry of special projections

Along [001] $61'$	Along [100] $p2m'g'$	Along [210] $p2m'g'$
Origin at 0,0,z	$\mathbf{a}^* = \mathbf{c}$ Origin at x,0,0	$\mathbf{a}^* = \mathbf{c}$ Origin at x,x/2,0

$\rho 6_3'/m'$

$6'/m'$

Hexagonal

No. 61.4.309

$\rho 6_3'/m'$

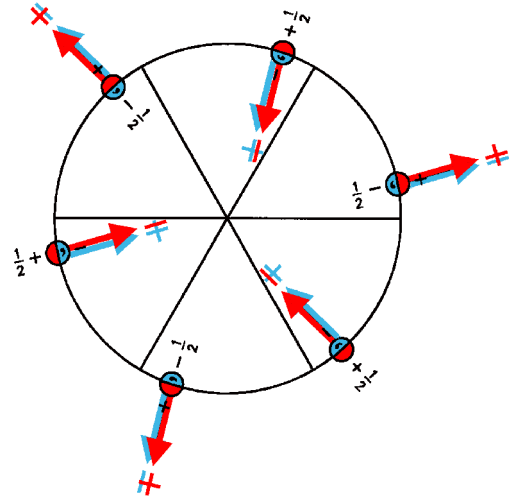
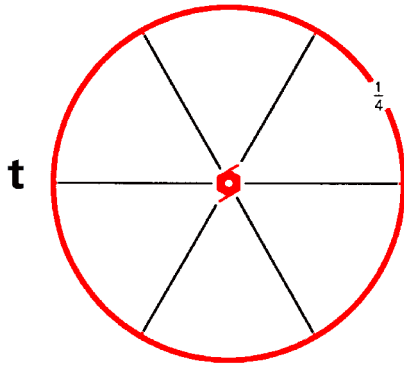

Origin at center ($\bar{3}$) on $6_3'$

Asymmetric unit $0 \leq x$; $0 \leq y$; $0 \leq z \leq 1/4$

Symmetry operations

- | | | |
|--|--|---|
| (1) 1
(1 0,0,0) | (2) 3^+ 0,0,z
(3_z 0,0,0) | (3) 3^- 0,0,z
(3_z^{-1} 0,0,0) |
| (4) $2'$ (0,0,1/2) 0,0,z
(2_z 0,0,1/2)' | (5) 6^- (0,0,1/2) 0,0,z
(6_z^{-1} 0,0,1/2)' | (6) 6^+ (0,0,1/2) 0,0,z
(6_z 0,0,1/2)' |
| (7) $\bar{1}$ 0,0,0
($\bar{1}$ 0,0,0) | (8) $\bar{3}^+$ 0,0,z; 0,0,0
($\bar{3}_z$ 0,0,0) | (9) $\bar{3}^-$ 0,0,z; 0,0,0
($\bar{3}_z^{-1}$ 0,0,0) |
| (10) m' x,y,1/4
(m_z 0,0,1/2)' | (11) $\bar{6}^-$ 0,0,z; 0,0,1/4
($\bar{6}_z^{-1}$ 0,0,1/2)' | (12) $\bar{6}^+$ 0,0,z; 0,0,1/4
($\bar{6}_z$ 0,0,1/2)' |

Generators selected (1); $t(0,0,1)$; (2); (4); (7)

Positions

	Coordinates		
Multiplicity, Wyckoff letter, Site symmetry			
12 e 1	(1) x,y,z [u,v,w]	(2) $\bar{y},x-y,z$ [$\bar{v},u-v,w$]	(3) $\bar{x}+y,\bar{x},z$ [$\bar{u}+v,\bar{u},w$]
	(4) $\bar{x},\bar{y},z+1/2$ [u,v, \bar{w}]	(5) $y,\bar{x}+y,z+1/2$ [$\bar{v},u-v,\bar{w}$]	(6) $x-y,x,z+1/2$ [$\bar{u}+v,\bar{u},\bar{w}$]
	(7) \bar{x},\bar{y},\bar{z} [u,v,w]	(8) $y,\bar{x}+y,\bar{z}$ [$\bar{v},u-v,w$]	(9) $x-y,x,\bar{z}$ [$\bar{u}+v,\bar{u},w$]
	(10) $x,y,\bar{z}+1/2$ [u,v, \bar{w}]	(11) $\bar{y},x-y,\bar{z}+1/2$ [$\bar{v},u-v,\bar{w}$]	(12) $\bar{x}+y,\bar{x},\bar{z}+1/2$ [$\bar{u}+v,\bar{u},\bar{w}$]
6 d m' ..	$x,y,1/4$ [u,v,0]	$\bar{y},x-y,1/4$ [$\bar{v},u-v,0$]	$\bar{x}+y,\bar{x},1/4$ [$\bar{u}+v,\bar{u},0$]
	$\bar{x},\bar{y},3/4$ [u,v,0]	$y,\bar{x}+y,3/4$ [$\bar{v},u-v,0$]	$x-y,x,3/4$ [$\bar{u}+v,\bar{u},0$]
4 c 3..	$0,0,z$ [0,0,w]	$0,0,z+1/2$ [0,0, \bar{w}]	
	$0,0,\bar{z}$ [0,0,w]	$0,0,\bar{z}+1/2$ [0,0, \bar{w}]	
2 b $\bar{3}$..	$0,0,0$ [0,0,w]	$0,0,1/2$ [0,0, \bar{w}]	
2 a $\bar{6}'$..	$0,0,1/4$ [0,0,0]	$0,0,3/4$ [0,0,0]	

Symmetry of special projections

Along [001] $61'$	Along [100] $p2'm'g$ $a^* = c$	Along [210] $p2'm'g$ $a^* = c$
Origin at 0,0,z	Origin at x,0,0	Origin at x,x/2,0

$p6_3'/m$

$6'/m$

Hexagonal

No. 61.5.310

$p6_3'/m$

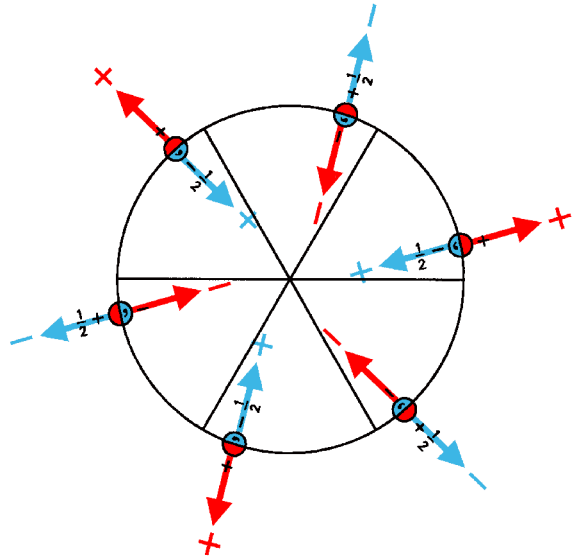
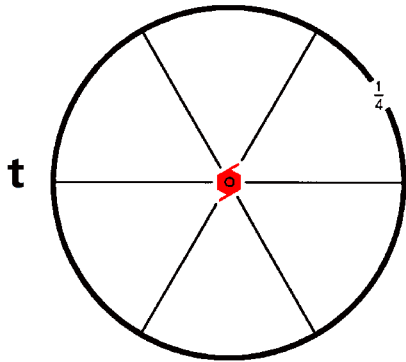

Origin at center ($\bar{3}$) on $6_3'$

Asymmetric unit $0 \leq x$; $0 \leq y$; $0 \leq z \leq 1/4$

Symmetry operations

- | | | |
|--|---|---|
| (1) 1
(1 0,0,0) | (2) 3^+ 0,0,z
(3_z 0,0,0) | (3) 3^- 0,0,z
(3_z^{-1} 0,0,0) |
| (4) $2'$ (0,0,1/2) 0,0,z
(2_z 0,0,1/2)' | (5) 6^- (0,0,1/2) 0,0,z
(6_z^{-1} 0,0,1/2)' | (6) 6^+ (0,0,1/2) 0,0,z
(6_z 0,0,1/2)' |
| (7) $\bar{1}'$ 0,0,0
($\bar{1}$ 0,0,0)' | (8) $\bar{3}^+$ 0,0,z; 0,0,0
($\bar{3}_z$ 0,0,0)' | (9) $\bar{3}^-$ 0,0,z; 0,0,0
($\bar{3}_z^{-1}$ 0,0,0)' |
| (10) m x,y,1/4
(m_z 0,0,1/2) | (11) $\bar{6}^-$ 0,0,z; 0,0,1/4
($\bar{6}_z^{-1}$ 0,0,1/2) | (12) $\bar{6}^+$ 0,0,z; 0,0,1/4
($\bar{6}_z$ 0,0,1/2) |

Generators selected (1); $t(0,0,1)$; (2); (4); (7)

Positions

	Coordinates		
Multiplicity, Wyckoff letter, Site symmetry			
12 e 1	(1) x,y,z [u,v,w]	(2) $\bar{y},x-y,z$ [$\bar{v},u-v,w$]	(3) $\bar{x}+y,\bar{x},z$ [$\bar{u}+v,\bar{u},w$]
	(4) $\bar{x},\bar{y},z+1/2$ [u,v, \bar{w}]	(5) $y,\bar{x}+y,z+1/2$ [$\bar{v},u-v,\bar{w}$]	(6) $x-y,x,z+1/2$ [$\bar{u}+v,\bar{u},\bar{w}$]
	(7) \bar{x},\bar{y},\bar{z} [\bar{u},\bar{v},\bar{w}]	(8) $y,\bar{x}+y,\bar{z}$ [$v,\bar{u}+v,\bar{w}$]	(9) $x-y,x,\bar{z}$ [u-v,u, \bar{w}]
	(10) $x,y,\bar{z}+1/2$ [\bar{u},\bar{v},w]	(11) $\bar{y},x-y,\bar{z}+1/2$ [$v,\bar{u}+v,w$]	(12) $\bar{x}+y,\bar{x},\bar{z}+1/2$ [u-v,u,w]
6 d m..	$x,y,1/4$ [0,0,w]	$\bar{y},x-y,1/4$ [0,0,w]	$\bar{x}+y,\bar{x},1/4$ [0,0,w]
	$\bar{x},\bar{y},3/4$ [0,0, \bar{w}]	$y,\bar{x}+y,3/4$ [0,0, \bar{w}]	$x-y,x,3/4$ [0,0, \bar{w}]
4 c 3..	$0,0,z$ [0,0,w]	$0,0,z+1/2$ [0,0, \bar{w}]	
	$0,0,\bar{z}$ [0,0, \bar{w}]	$0,0,\bar{z}+1/2$ [0,0,w]	
2 b $\bar{3}'..$	$0,0,0$ [0,0,0]	$0,0,1/2$ [0,0,0]	
2 a $\bar{6}..$	$0,0,1/4$ [0,0,w]	$0,0,3/4$ [0,0, \bar{w}]	

Symmetry of special projections

Along [001] $6'$	Along [100] $p2mg$	Along [210] $p2mg$
Origin at 0,0,z	$a^* = c$ Origin at x,0,0	$a^* = c$ Origin at x,x/2,0

p622

622

Hexagonal

No. 62.1.311

p622

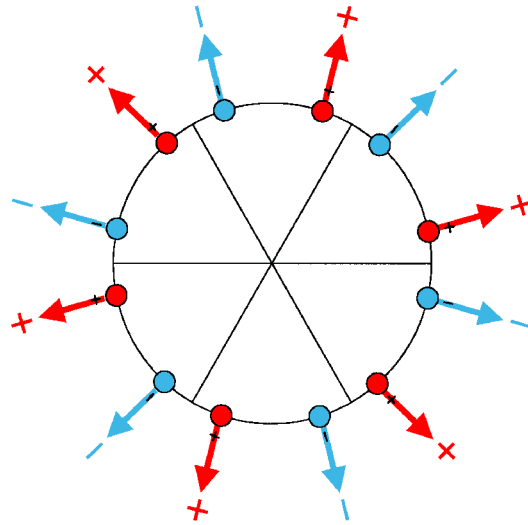
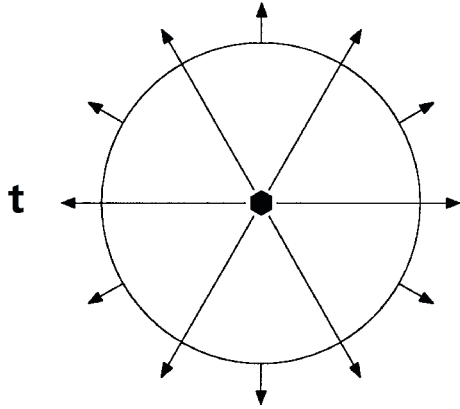

Origin at 622

Asymmetric unit $0 \leq x$; $0 \leq y$; $0 \leq z \leq 1/2$; $y \leq x$

Symmetry operations

- | | | |
|---|---|---|
| (1) 1
(1 0,0,0) | (2) 3^+ 0,0,z
(3_z 0,0,0) | (3) 3^- 0,0,z
(3_z^{-1} 0,0,0) |
| (4) 2 0,0,z
(2_z 0,0,0) | (5) 6^- 0,0,z
(6_z^{-1} 0,0,0) | (6) 6^+ 0,0,z
(6_z 0,0,0) |
| (7) 2 x,x,0
(2_{xy} 0,0,0) | (8) 2 x,0,0
(2_x 0,0,0) | (9) 2 0,y,0
(2_y 0,0,0) |
| (10) 2 x, \bar{x} ,0
(2_3 0,0,0) | (11) 2 x,2x,0
(2_2 0,0,0) | (12) 2 2x,x,0
(2_1 0,0,0) |

Generators selected (1); $t(0,0,1)$; (2); (4); (7)

Positions

	Coordinates		
Multiplicity, Wyckoff letter, Site symmetry			
12 h 1	(1) x,y,z $[u,v,w]$	(2) $\bar{y},x-y,z$ $[\bar{v},u-v,w]$	(3) $\bar{x}+y,\bar{x},z$ $[\bar{u}+v,\bar{u},w]$
	(4) \bar{x},\bar{y},z $[\bar{u},\bar{v},w]$	(5) $y,\bar{x}+y,z$ $[v,\bar{u}+v,w]$	(6) $x-y,x,z$ $[u-v,u,w]$
	(7) y,x,\bar{z} $[v,u,\bar{w}]$	(8) $x-y,\bar{y},\bar{z}$ $[u-v,\bar{v},\bar{w}]$	(9) $\bar{x},\bar{x}+y,\bar{z}$ $[\bar{u},\bar{u}+v,\bar{w}]$
	(10) \bar{y},\bar{x},\bar{z} $[\bar{v},\bar{u},\bar{w}]$	(11) $\bar{x}+y,y,\bar{z}$ $[\bar{u}+v,v,\bar{w}]$	(12) $x,x-y,\bar{z}$ $[u,u-v,\bar{w}]$
6 g ..2	$x,\bar{x},1/2$ $[u,\bar{u},0]$	$x,2x,1/2$ $[u,2u,0]$	$2\bar{x},\bar{x},1/2$ $[2\bar{u},\bar{u},0]$
	$\bar{x},x,1/2$ $[\bar{u},u,0]$	$\bar{x},2\bar{x},1/2$ $[\bar{u},2\bar{u},0]$	$2x,x,1/2$ $[2u,u,0]$
6 f ..2	$x,\bar{x},0$ $[u,\bar{u},0]$	$x,2x,0$ $[u,2u,0]$	$2\bar{x},\bar{x},0$ $[2\bar{u},\bar{u},0]$
	$\bar{x},x,0$ $[\bar{u},u,0]$	$\bar{x},2\bar{x},0$ $[\bar{u},2\bar{u},0]$	$2x,x,0$ $[2u,u,0]$
6 e .2.	$x,0,1/2$ $[u,0,0]$	$0,x,1/2$ $[0,u,0]$	$\bar{x},\bar{x},1/2$ $[\bar{u},\bar{u},0]$
	$\bar{x},0,1/2$ $[\bar{u},0,0]$	$0,\bar{x},1/2$ $[0,\bar{u},0]$	$x,x,1/2$ $[u,u,0]$
6 d .2.	$x,0,0$ $[u,0,0]$	$0,x,0$ $[0,u,0]$	$\bar{x},\bar{x},0$ $[\bar{u},\bar{u},0]$
	$\bar{x},0,0$ $[\bar{u},0,0]$	$0,\bar{x},0$ $[0,\bar{u},0]$	$x,x,0$ $[u,u,0]$
2 c 6..	$0,0,z$ $[0,0,w]$	$0,0,\bar{z}$ $[0,0,\bar{w}]$	
1 b 622	$0,0,1/2$ $[0,0,0]$		
1 a 622	$0,0,0$ $[0,0,0]$		

Symmetry of special projectionsAlong [001] $6m'm'$

Origin at 0,0,z

Along [100] $p2m'm'$ $a^* = c$

Origin at x,0,0

Along [210] $p2m'm'$ $a^* = c$

Origin at x,x/2,0

$p6221'$

$6221'$

Hexagonal

No. 62.2.312

$p6221'$

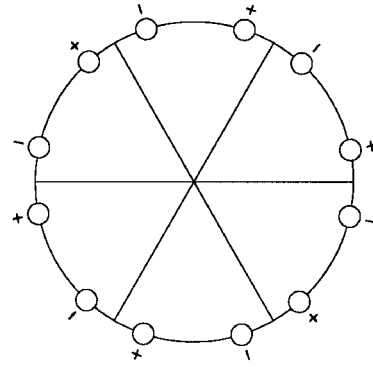
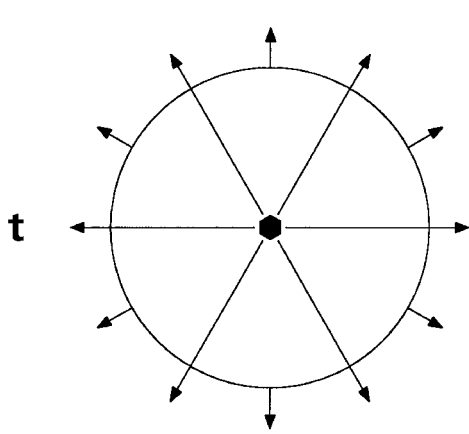

Origin at $6221'$

Asymmetric unit $0 \leq x; 0 \leq y; 0 \leq z \leq 1/2; y \leq x$

Symmetry operations

For 1 + set

- | | | |
|---|---|---|
| (1) 1
(1 0,0,0) | (2) 3^+ 0,0,z
(3_z 0,0,0) | (3) 3^- 0,0,z
(3_z^{-1} 0,0,0) |
| (4) 2 0,0,z
(2_z 0,0,0) | (5) 6^- 0,0,z
(6_z^{-1} 0,0,0) | (6) 6^+ 0,0,z
(6_z 0,0,0) |
| (7) 2 x,x,0
(2_{xy} 0,0,0) | (8) 2 x,0,0
(2_x 0,0,0) | (9) 2 0,y,0
(2_y 0,0,0) |
| (10) 2 x, \bar{x} ,0
(2_3 0,0,0) | (11) 2 x,2x,0
(2_2 0,0,0) | (12) 2 2x,x,0
(2_1 0,0,0) |

For 1' + set

- | | | |
|---|---|---|
| (1) 1'
(1 0,0,0)' | (2) $3^{+'}$ 0,0,z
(3_z 0,0,0)' | (3) $3^{-'}$ 0,0,z
(3_z^{-1} 0,0,0)' |
| (4) 2' 0,0,z
(2_z 0,0,0)' | (5) $6^{-'}$ 0,0,z
(6_z^{-1} 0,0,0)' | (6) $6^{+'}$ 0,0,z
(6_z 0,0,0)' |
| (7) 2' x,x,0
(2_{xy} 0,0,0)' | (8) 2' x,0,0
(2_x 0,0,0)' | (9) 2' 0,y,0
(2_y 0,0,0)' |
| (10) 2' x, \bar{x} ,0
(2_3 0,0,0)' | (11) 2' x,2x,0
(2_2 0,0,0)' | (12) 2' 2x,x,0
(2_1 0,0,0)' |

Generators selected (1); t(0,0,1); (2); (4); (7); 1'

Positions

Multiplicity, Wyckoff letter, Site symmetry	Coordinates		
	1+	1' +	
12 h 11'	(1) x,y,z [0,0,0] (4) \bar{x},\bar{y},z [0,0,0] (7) y,x,\bar{z} [0,0,0] (10) \bar{y},\bar{x},\bar{z} [0,0,0]	(2) $\bar{y},x-y,z$ [0,0,0] (5) $y,\bar{x}+y,z$ [0,0,0] (8) $x-y,\bar{y},\bar{z}$ [0,0,0] (11) $\bar{x}+y,y,\bar{z}$ [0,0,0]	(3) $\bar{x}+y,\bar{x},z$ [0,0,0] (6) $x-y,x,z$ [0,0,0] (9) $\bar{x},\bar{x}+y,\bar{z}$ [0,0,0] (12) $x,x-y,\bar{z}$ [0,0,0]
6 g ..21'	$x,\bar{x},1/2$ [0,0,0] $\bar{x},x,1/2$ [0,0,0]	$x,2x,1/2$ [0,0,0] $\bar{x},2\bar{x},1/2$ [0,0,0]	$2\bar{x},\bar{x},1/2$ [0,0,0] $2x,x,1/2$ [0,0,0]
6 f ..21'	$x,\bar{x},0$ [0,0,0] $\bar{x},x,0$ [0,0,0]	$x,2x,0$ [0,0,0] $\bar{x},2\bar{x},0$ [0,0,0]	$2\bar{x},\bar{x},0$ [0,0,0] $2x,x,0$ [0,0,0]
6 e .2.1'	$x,0,1/2$ [0,0,0] $\bar{x},0,1/2$ [0,0,0]	$0,x,1/2$ [0,0,0] $0,\bar{x},1/2$ [0,0,0]	$\bar{x},\bar{x},1/2$ [0,0,0] $x,x,1/2$ [0,0,0]
6 d .2.1'	$x,0,0$ [0,0,0] $\bar{x},0,0$ [0,0,0]	$0,x,0$ [0,0,0] $0,\bar{x},0$ [0,0,0]	$\bar{x},\bar{x},0$ [0,0,0] $x,x,0$ [0,0,0]
2 c 6..1'	$0,0,z$ [0,0,0]	$0,0,\bar{z}$ [0,0,0]	
1 b 6221'	$0,0,1/2$ [0,0,0]		
1 a 6221'	$0,0,0$ [0,0,0]		

Continued

No. 62.2.312

$p6221'$

Symmetry of special projections

Along $[001]$ $6mm1'$

Origin at $0,0,z$

Along $[100]$ $p2mm1'$

$a^* = c$

Origin at $x,0,0$

Along $[210]$ $p2mm1'$

$a^* = c$

Origin at $x,x/2,0$

$p62'2'$

$62'2'$

Hexagonal

No. 62.3.313

$p62'2'$

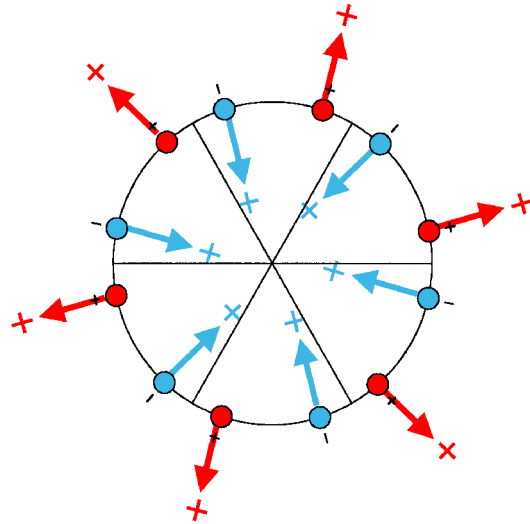
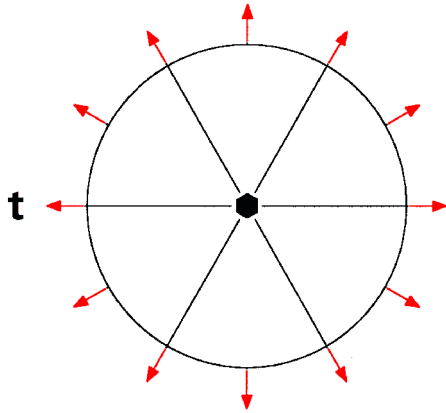

Origin at $62'2'$

Asymmetric unit $0 \leq x$; $0 \leq y$; $0 \leq z \leq 1/2$; $y \leq x$

Symmetry operations

- | | | |
|---|---|---|
| (1) 1
(1 0,0,0) | (2) 3^+ 0,0,z
(3_z 0,0,0) | (3) 3^- 0,0,z
(3_z^{-1} 0,0,0) |
| (4) 2 0,0,z
(2_z 0,0,0) | (5) 6^- 0,0,z
(6_z^{-1} 0,0,0) | (6) 6^+ 0,0,z
(6_z 0,0,0) |
| (7) $2'$ x,x,0
(2_{xy} 0,0,0)' | (8) $2'$ x,0,0
(2_x 0,0,0)' | (9) $2'$ 0,y,0
(2_y 0,0,0)' |
| (10) $2'$ x, \bar{x} ,0
(2_3 0,0,0)' | (11) $2'$ x,2x,0
(2_2 0,0,0)' | (12) $2'$ 2x,x,0
(2_1 0,0,0)' |

Generators selected (1); t(0,0,1); (2); (4); (7)

Positions

	Coordinates		
Multiplicity, Wyckoff letter, Site symmetry			
12 h 1	(1) x,y,z [u,v,w]	(2) $\bar{y},x-y,z$ [$\bar{v},u-v,w$]	(3) $\bar{x}+y,\bar{x},z$ [$\bar{u}+v,\bar{u},w$]
	(4) \bar{x},\bar{y},z [\bar{u},\bar{v},w]	(5) $y,\bar{x}+y,z$ [$v,\bar{u}+v,w$]	(6) $x-y,x,z$ [u-v,u,w]
	(7) y,x,\bar{z} [\bar{v},\bar{u},w]	(8) $x-y,\bar{y},\bar{z}$ [$\bar{u}+v,v,w$]	(9) $\bar{x},\bar{x}+y,\bar{z}$ [u,u-v,w]
	(10) \bar{y},\bar{x},\bar{z} [v,u,w]	(11) $\bar{x}+y,y,\bar{z}$ [u-v, \bar{v},w]	(12) $x,x-y,\bar{z}$ [$\bar{u},\bar{u}+v,w$]
6 g ..2'	$x,\bar{x},1/2$ [u,u,w]	$x,2x,1/2$ [$\bar{u},0,w$]	$2\bar{x},\bar{x},1/2$ [0, \bar{u},w]
	$\bar{x},x,1/2$ [\bar{u},\bar{u},w]	$\bar{x},2\bar{x},1/2$ [u,0,w]	$2x,x,1/2$ [0,u,w]
6 f ..2'	$x,\bar{x},0$ [u,u,w]	$x,2x,0$ [$\bar{u},0,w$]	$2\bar{x},\bar{x},0$ [0, \bar{u},w]
	$\bar{x},x,0$ [\bar{u},\bar{u},w]	$\bar{x},2\bar{x},0$ [u,0,w]	$2x,x,0$ [0,u,w]
6 e .2'	$x,0,1/2$ [u,2u,w]	$0,x,1/2$ [$2\bar{u},\bar{u},w$]	$\bar{x},\bar{x},1/2$ [u, \bar{u},w]
	$\bar{x},0,1/2$ [$\bar{u},2\bar{u},w$]	$0,\bar{x},1/2$ [2u,u,w]	$x,x,1/2$ [\bar{u},u,w]
6 d .2'	$x,0,0$ [u,2u,w]	$0,x,0$ [$2\bar{u},\bar{u},w$]	$\bar{x},\bar{x},0$ [u, \bar{u},w]
	$\bar{x},0,0$ [$\bar{u},2\bar{u},w$]	$0,\bar{x},0$ [2u,u,w]	$x,x,0$ [\bar{u},u,w]
2 c 6..	$0,0,z$ [0,0,w]	$0,0,\bar{z}$ [0,0,w]	
1 b 62'2'	$0,0,1/2$ [0,0,w]		
1 a 62'2'	$0,0,0$ [0,0,w]		

Continued

No. 62.3.313

$p62'2'$

Symmetry of special projections

Along [001] 6mm

Origin at 0,0,z

Along [100] $p2'mm'$

$a^* = c$

Origin at x,0,0

Along [210] $p2'mm'$

$a^* = c$

Origin at x,x/2,0

$p6'2'2$

$6'2'2$

Hexagonal

No. 62.4.314

$p6'2'2$

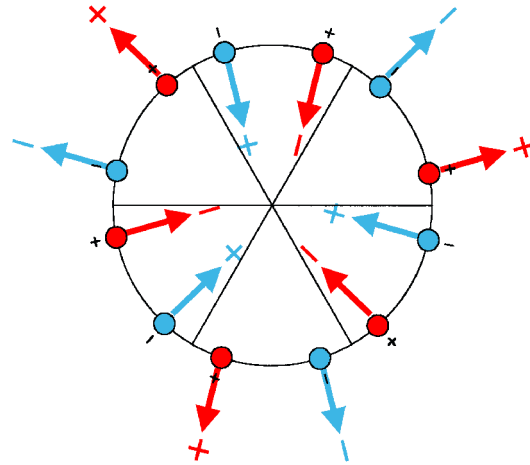
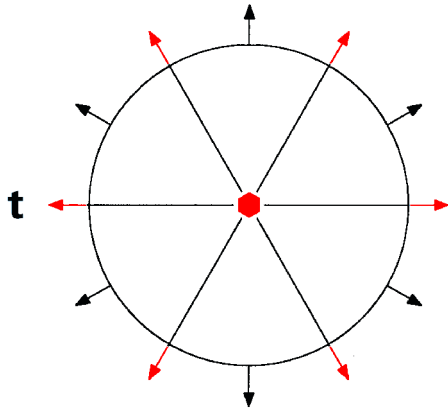

Origin at $6'2'2$

Asymmetric unit $0 \leq x$; $0 \leq y$; $0 \leq z \leq 1/2$; $y \leq x$

Symmetry operations

- | | | |
|---|--|---|
| (1) 1
(1 0,0,0) | (2) 3^+ 0,0,z
(3_z 0,0,0) | (3) 3^- 0,0,z
(3_z^{-1} 0,0,0) |
| (4) 2^z 0,0,z
(2_z 0,0,0)' | (5) 6^- 0,0,z
(6_z^{-1} 0,0,0)' | (6) 6^+ 0,0,z
(6_z 0,0,0)' |
| (7) 2^x x,x,0
(2_{xy} 0,0,0)' | (8) 2^x x,0,0
(2_x 0,0,0)' | (9) 2^y 0,y,0
(2_y 0,0,0)' |
| (10) 2^x x, \bar{x} ,0
(2_3 0,0,0) | (11) 2^x x,2x,0
(2_2 0,0,0) | (12) 2^x 2x,x,0
(2_1 0,0,0) |

Generators selected (1); t(0,0,1); (2); (4); (7)

Positions

	Coordinates		
Multiplicity, Wyckoff letter, Site symmetry			
12 h 1	(1) x,y,z [u,v,w]	(2) $\bar{y},x-y,z$ [$\bar{v},u-v,w$]	(3) $\bar{x}+y,\bar{x},z$ [$\bar{u}+v,\bar{u},w$]
	(4) \bar{x},\bar{y},z [u,v, \bar{w}]	(5) $y,\bar{x}+y,z$ [$\bar{v},u-v,\bar{w}$]	(6) $x-y,x,z$ [$\bar{u}+v,\bar{u},\bar{w}$]
	(7) y,x,\bar{z} [\bar{v},\bar{u},w]	(8) $x-y,\bar{y},\bar{z}$ [$\bar{u}+v,v,w$]	(9) $\bar{x},\bar{x}+y,\bar{z}$ [u,u-v,w]
	(10) \bar{y},\bar{x},\bar{z} [\bar{v},\bar{u},\bar{w}]	(11) $\bar{x}+y,y,\bar{z}$ [$\bar{u}+v,v,\bar{w}$]	(12) $x,x-y,\bar{z}$ [u,u-v, \bar{w}]
6 g ..2	$x,\bar{x},1/2$ [u, \bar{u} ,0]	$x,2x,1/2$ [u,2u,0]	$2\bar{x},\bar{x},1/2$ [2 \bar{u} , \bar{u} ,0]
	$\bar{x},x,1/2$ [u, \bar{u} ,0]	$\bar{x},2\bar{x},1/2$ [u,2u,0]	$2x,x,1/2$ [2 \bar{u} , \bar{u} ,0]
6 f ..2	$x,\bar{x},0$ [u, \bar{u} ,0]	$x,2x,0$ [u,2u,0]	$2\bar{x},\bar{x},0$ [2 \bar{u} , \bar{u} ,0]
	$\bar{x},x,0$ [u, \bar{u} ,0]	$\bar{x},2\bar{x},0$ [u,2u,0]	$2x,x,0$ [2 \bar{u} , \bar{u} ,0]
6 e .2'	$x,0,1/2$ [u,2u,w]	$0,x,1/2$ [2 \bar{u} , \bar{u} ,w]	$\bar{x},\bar{x},1/2$ [u, \bar{u} ,w]
	$\bar{x},0,1/2$ [u,2u, \bar{w}]	$0,\bar{x},1/2$ [2 \bar{u} , \bar{u} , \bar{w}]	$x,x,1/2$ [u, \bar{u} , \bar{w}]
6 d .2'	$x,0,0$ [u,2u,w]	$0,x,0$ [2 \bar{u} , \bar{u} ,w]	$\bar{x},\bar{x},0$ [u, \bar{u} ,w]
	$\bar{x},0,0$ [u,2u, \bar{w}]	$0,\bar{x},0$ [2 \bar{u} , \bar{u} , \bar{w}]	$x,x,0$ [u, \bar{u} , \bar{w}]
2 c 6'..	$0,0,z$ [0,0,0]	$0,0,\bar{z}$ [0,0,0]	
1 b 6'2'2	$0,0,1/2$ [0,0,0]		
1 a 6'2'2	$0,0,0$ [0,0,0]		

Continued

No. 62.4.314

$p6'2'2$

Symmetry of special projections

Along [001] $6'm'm$

Origin at 0,0,z

Along [100] $p2'm'm$

$a^* = c$

Origin at x,0,0

Along [210] $p2mm$

$a^* = c$

Origin at x,x/2,0

$p_{2c}6'22'$

$6221'$

Hexagonal

No. 62.5.315

$p_{2c}6'22'$

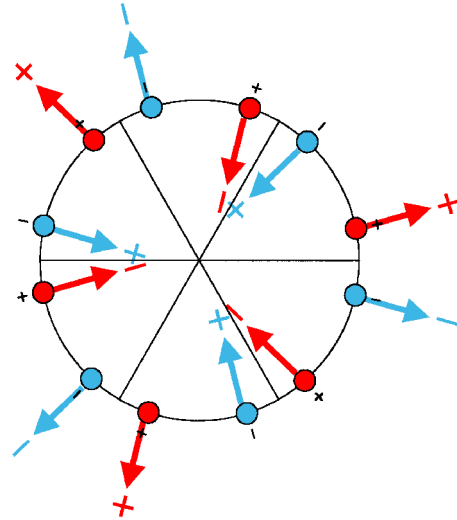
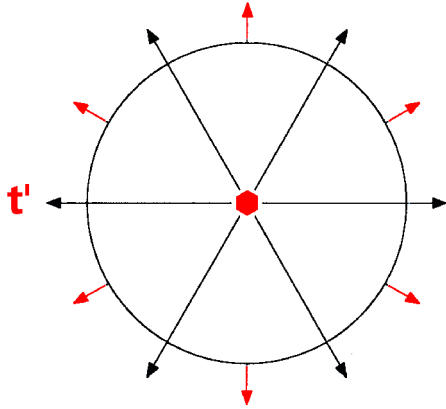

Origin at $6'22'$

Asymmetric unit $0 \leq x; 0 \leq y; 0 \leq z \leq 1/2; y \leq x$

Symmetry operations

For $(0,0,0) +$ set

- | | | |
|---|--|---|
| (1) 1
(1 0,0,0) | (2) 3^+ 0,0,z
(3_z 0,0,0) | (3) 3^- 0,0,z
(3_z^{-1} 0,0,0) |
| (4) $2'$ 0,0,z
(2_z 0,0,0)' | (5) 6^- 0,0,z
(6_z^{-1} 0,0,0)' | (6) 6^+ 0,0,z
(6_z 0,0,0)' |
| (7) 2 x,x,0
(2_{xy} 0,0,0) | (8) 2 x,0,0
(2_x 0,0,0) | (9) 2 0,y,0
(2_y 0,0,0) |
| (10) $2'$ x, \bar{x} ,0
(2_3 0,0,0)' | (11) $2'$ x,2x,0
(2_2 0,0,0)' | (12) $2'$ 2x,x,0
(2_1 0,0,0)' |

For $(0,0,1) +$ set

- | | | |
|---|--|---|
| (1) t' (0,0,1)
(1 0,0,1)' | (2) $3^{+'}$ (0,0,1) 0,0,z
(3_z 0,0,1)' | (3) $3^{-'}$ (0,0,1) 0,0,z
(3_z^{-1} 0,0,1)' |
| (4) 2 (0,0,1) 0,0,z
(2_z 0,0,1) | (5) $6^{-'}$ (0,0,1) 0,0,z
(6_z^{-1} 0,0,1) | (6) $6^{+'}$ (0,0,1) 0,0,z
(6_z 0,0,1) |
| (7) $2'$ x,x,1/2
(2_{xy} 0,0,1)' | (8) $2'$ x,0,1/2
(2_x 0,0,1)' | (9) $2'$ 0,y,1/2
(2_y 0,0,1)' |
| (10) 2 x, \bar{x} ,1/2
(2_3 0,0,1) | (11) 2 x,2x,1/2
(2_2 0,0,1) | (12) 2 2x,x,1/2
(2_1 0,0,1) |

Generators selected (1); $t(0,0,1)'$; (2); (4); (7)

Positions

Multiplicity, Wyckoff letter, Site symmetry	Coordinates		
	(0,0,0)+	(0,0,1)' +	
12 h 1	(1) $x,y,z [u,v,w]$	(2) $\bar{y},x-y,z [\bar{v},u-v,w]$	(3) $\bar{x}+y,\bar{x},z [\bar{u}+v,\bar{u},w]$
	(4) $\bar{x},\bar{y},z [u,v,\bar{w}]$	(5) $y,\bar{x}+y,z [\bar{v},u-v,\bar{w}]$	(6) $x-y,x,z [\bar{u}+v,\bar{u},\bar{w}]$
	(7) $y,x,\bar{z} [v,u,\bar{w}]$	(8) $x-y,\bar{y},\bar{z} [u-v,\bar{v},\bar{w}]$	(9) $\bar{x},\bar{x}+y,\bar{z} [\bar{u},\bar{u}+v,\bar{w}]$
	(10) $\bar{y},\bar{x},\bar{z} [v,u,w]$	(11) $\bar{x}+y,y,\bar{z} [u-v,\bar{v},w]$	(12) $x,x-y,\bar{z} [\bar{u},\bar{u}+v,w]$
6 g ..2	$x,\bar{x},1/2 [u,\bar{u},0]$	$x,2x,1/2 [u,2u,0]$	$2\bar{x},\bar{x},1/2 [2\bar{u},\bar{u},0]$
	$\bar{x},x,1/2 [u,\bar{u},0]$	$\bar{x},2\bar{x},1/2 [u,2u,0]$	$2x,x,1/2 [2\bar{u},\bar{u},0]$
6 f ..2'	$x,\bar{x},0 [u,u,w]$	$x,2x,0 [\bar{u},0,w]$	$2\bar{x},\bar{x},0 [0,\bar{u},w]$
	$\bar{x},x,0 [u,u,\bar{w}]$	$\bar{x},2\bar{x},0 [\bar{u},0,\bar{w}]$	$2x,x,0 [0,\bar{u},\bar{w}]$
6 e .2'	$x,0,1/2 [u,2u,w]$	$0,x,1/2 [2\bar{u},\bar{u},w]$	$\bar{x},\bar{x},1/2 [u,\bar{u},w]$
	$\bar{x},0,1/2 [u,2u,\bar{w}]$	$0,\bar{x},1/2 [2\bar{u},\bar{u},\bar{w}]$	$x,x,1/2 [u,\bar{u},\bar{w}]$
6 d .2.	$x,0,0 [u,0,0]$	$0,x,0 [0,u,0]$	$\bar{x},\bar{x},0 [\bar{u},\bar{u},0]$
	$\bar{x},0,0 [u,0,0]$	$0,\bar{x},0 [0,u,0]$	$x,x,0 [\bar{u},\bar{u},0]$
2 c 6'..	$0,0,z [0,0,0]$	$0,0,\bar{z} [0,0,0]$	
1 b 6'2'2	$0,0,1/2 [0,0,0]$		
1 a 6'22'	$0,0,0 [0,0,0]$		

Continued

No. 62.5.315

$\rho_{2c} 6'22'$

Symmetry of special projections

Along [001] $6mm1'$

Origin at 0,0,z

Along [100] $\rho_{2a^*} 2mm$

$a^* = c$

Origin at x,0,0

Along [210] $\rho_{2a^*} 2'm'm$

$a^* = c$

Origin at x,x/2,0

$p_{2c}622$

6221'

Hexagonal

No. 62.6.316

$p_{2c}622$

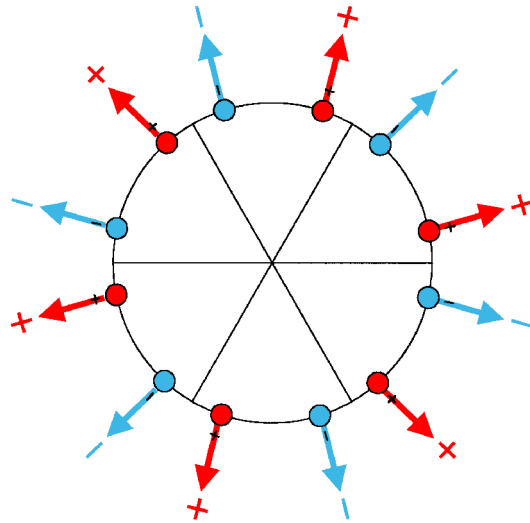
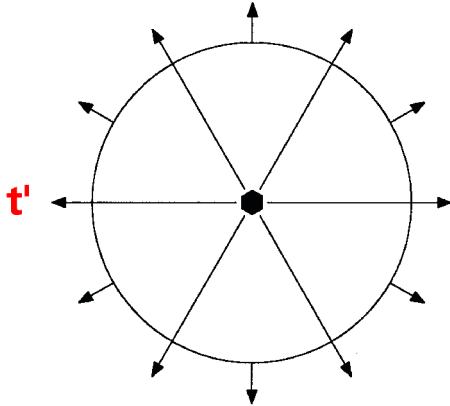

Origin at 622

Asymmetric unit $0 \leq x; 0 \leq y; 0 \leq z \leq 1/2; y \leq x$

Symmetry operations

For (0,0,0) + set

- | | | |
|---|---|---|
| (1) 1
(1 0,0,0) | (2) 3^+ 0,0,z
(3_z 0,0,0) | (3) 3^- 0,0,z
(3_z^{-1} 0,0,0) |
| (4) 2 0,0,z
(2_z 0,0,0) | (5) 6^- 0,0,z
(6_z^{-1} 0,0,0) | (6) 6^+ 0,0,z
(6_z 0,0,0) |
| (7) 2 x,x,0
(2_{xy} 0,0,0) | (8) 2 x,0,0
(2_x 0,0,0) | (9) 2 0,y,0
(2_y 0,0,0) |
| (10) 2 x, \bar{x} ,0
(2_3 0,0,0) | (11) 2 x,2x,0
(2_2 0,0,0) | (12) 2 2x,x,0
(2_1 0,0,0) |

For (0,0,1)' + set

- | | | |
|---|---|---|
| (1) t' (0,0,1)
(1 0,0,1)' | (2) $3^{+'}$ (0,0,1) 0,0,z
(3_z 0,0,1)' | (3) $3^{-'}$ (0,0,1) 0,0,z
(3_z^{-1} 0,0,1)' |
| (4) $2'$ (0,0,1) 0,0,z
(2_z 0,0,1)' | (5) $6^{-'}$ (0,0,1) 0,0,z
(6_z^{-1} 0,0,1)' | (6) $6^{+'}$ (0,0,1) 0,0,z
(6_z 0,0,1)' |
| (7) $2'$ x,x,1/2
(2_{xy} 0,0,1)' | (8) $2'$ x,0,1/2
(2_x 0,0,1)' | (9) $2'$ 0,y,1/2
(2_y 0,0,1)' |
| (10) $2'$ x, \bar{x} ,1/2
(2_3 0,0,1)' | (11) $2'$ x,2x,1/2
(2_2 0,0,1)' | (12) $2'$ 2x,x,1/2
(2_1 0,0,1)' |

Generators selected (1); $t(0,0,1)'$; (2); (4); (7)

Positions

Multiplicity, Wyckoff letter, Site symmetry	Coordinates		
		(0,0,0)+	(0,0,1)' +
12 h 1	(1) x,y,z [u,v,w]	(2) $\bar{y},x-y,z$ [$\bar{v},u-v,w$]	(3) $\bar{x}+y,\bar{x},z$ [$\bar{u}+v,\bar{u},w$]
	(4) \bar{x},\bar{y},z [\bar{u},\bar{v},w]	(5) $y,\bar{x}+y,z$ [$v,\bar{u}+v,w$]	(6) $x-y,x,z$ [u-v,u,w]
	(7) y,x,\bar{z} [v,u, \bar{w}]	(8) $x-y,\bar{y},\bar{z}$ [u-v, \bar{v},\bar{w}]	(9) $\bar{x},\bar{x}+y,\bar{z}$ [$\bar{u},\bar{u}+v,\bar{w}$]
	(10) \bar{y},\bar{x},\bar{z} [\bar{v},\bar{u},\bar{w}]	(11) $\bar{x}+y,y,\bar{z}$ [$\bar{u}+v,v,\bar{w}$]	(12) $x,x-y,\bar{z}$ [u,u-v, \bar{w}]
6 g ..2'	$x,\bar{x},1/2$ [u,u,w]	$x,2x,1/2$ [$\bar{u},0,w$]	$2\bar{x},\bar{x},1/2$ [0, \bar{u},w]
	$\bar{x},x,1/2$ [\bar{u},\bar{u},w]	$\bar{x},2\bar{x},1/2$ [u,0,w]	$2x,x,1/2$ [0,u,w]
6 f ..2	$x,\bar{x},0$ [u, $\bar{u},0$]	$x,2x,0$ [u,2u,0]	$2\bar{x},\bar{x},0$ [2 $\bar{u},\bar{u},0$]
	$\bar{x},x,0$ [$\bar{u},u,0$]	$\bar{x},2\bar{x},0$ [$\bar{u},2\bar{u},0$]	$2x,x,0$ [2u,u,0]
6 e .2'	$x,0,1/2$ [u,2u,w]	$0,x,1/2$ [2 \bar{u},\bar{u},w]	$\bar{x},\bar{x},1/2$ [u, \bar{u},w]
	$\bar{x},0,1/2$ [$\bar{u},2\bar{u},w$]	$0,\bar{x},1/2$ [2u,u,w]	$x,x,1/2$ [\bar{u},u,w]
6 d .2.	$x,0,0$ [u,0,0]	$0,x,0$ [0,u,0]	$\bar{x},\bar{x},0$ [$\bar{u},\bar{u},0$]
	$\bar{x},0,0$ [$\bar{u},0,0$]	$0,\bar{x},0$ [0, $\bar{u},0$]	$x,x,0$ [u,u,0]
2 c 6..	$0,0,z$ [0,0,w]	$0,0,\bar{z}$ [0,0, \bar{w}]	
1 b 6'2'2'	$0,0,1/2$ [0,0,w]		
1 a 622	$0,0,0$ [0,0,0]		

Symmetry of special projections

Along [001] $6mm1'$	Along [100] $p_{2a^*}2m'm'$ $a^* = c$	Along [210] $p_{2a^*}2m'm'$ $a^* = c$
Origin at 0,0,z	Origin at x,0,0	Origin at x,x/2,0

$p6_122$

622

Hexagonal

No. 63.1.317

$p6_122$

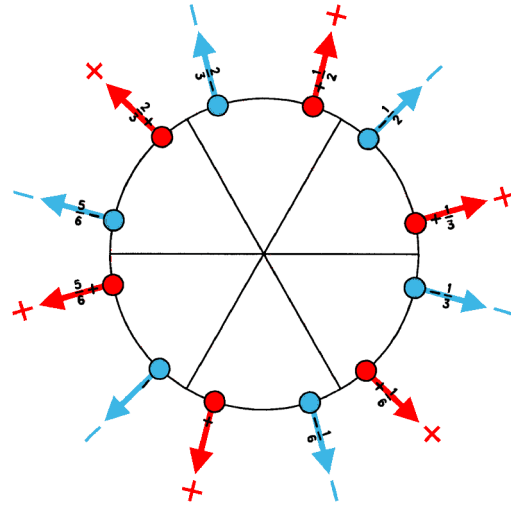
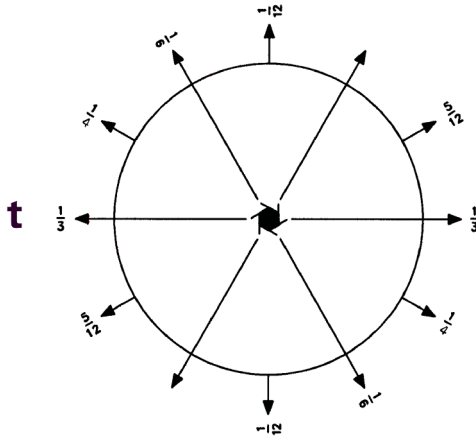

Origin on $2[100]$ at $6_1(2,1,1)1$

Asymmetric unit $0 \leq z \leq 1/12$

Symmetry operations

- | | | |
|--|---|---|
| (1) 1
(1 0,0,0) | (2) 3^+ (0,0,1/3) 0,0,z
(3_z 0,0,1/3) | (3) 3^- (0,0,2/3) 0,0,z
(3_z^{-1} 0,0,2/3) |
| (4) 2 (0,0,1/2) 0,0,z
(2_z 0,0,1/2) | (5) 6^- (0,0,5/6) 0,0,z
(6_z^{-1} 0,0,5/6) | (6) 6^+ (0,0,1/6) 0,0,z
(6_z 0,0,1/6) |
| (7) 2 x,x,1/6
(2_{xy} 0,0,1/3) | (8) 2 x,0,0
(2_x 0,0,0) | (9) 2 0,y,1/3
(2_y 0,0,2/3) |
| (10) 2 x, \bar{x} ,5/12
(2_3 0,0,5/6) | (11) 2 x,2x,1/4
(2_2 0,0,1/2) | (12) 2 2x,x,1/12
(2_1 0,0,1/6) |

Generators selected (1); t(0,0,1); (2); (4); (7)

Positions

	Coordinates		
Multiplicity, Wyckoff letter, Site symmetry			
12 c 1	(1) x,y,z [u,v,w]	(2) $\bar{y},x-y,z+1/3$ [$\bar{v},u-v,w$]	(3) $\bar{x}+y,\bar{x},z+2/3$ [$\bar{u}+v,\bar{u},w$]
	(4) $\bar{x},\bar{y},z+1/2$ [\bar{u},\bar{v},w]	(5) $y,\bar{x}+y,z+5/6$ [$v,\bar{u}+v,w$]	(6) $x-y,x,z+1/6$ [$u-v,u,w$]
	(7) $y,x,\bar{z}+1/3$ [v,u,\bar{w}]	(8) $x-y,\bar{y},\bar{z}$ [$u-v,\bar{v},\bar{w}$]	(9) $\bar{x},\bar{x}+y,\bar{z}+2/3$ [$\bar{u},\bar{u}+v,\bar{w}$]
	(10) $\bar{y},\bar{x},\bar{z}+5/6$ [\bar{v},\bar{u},\bar{w}]	(11) $\bar{x}+y,y,\bar{z}+1/2$ [$\bar{u}+v,v,\bar{w}$]	(12) $x,x-y,\bar{z}+1/6$ [$u,u-v,\bar{w}$]
6 b ..2	$x,2x,1/4$ [u,2u,0]	$2\bar{x},\bar{x},7/12$ [$2\bar{u},\bar{u},0$]	$x,\bar{x},11/12$ [u, \bar{u} ,0]
	$\bar{x},2\bar{x},3/4$ [$\bar{u},2\bar{u},0$]	$2x,x,1/12$ [2u,u,0]	$\bar{x},x,5/12$ [$\bar{u},u,0$]
6 a .2.	$x,0,0$ [u,0,0]	$0,x,1/3$ [0,u,0]	$\bar{x},\bar{x},2/3$ [$\bar{u},\bar{u},0$]
	$\bar{x},0,1/2$ [$\bar{u},0,0$]	$0,\bar{x},5/6$ [0, \bar{u} ,0]	$x,x,1/6$ [u,u,0]

Symmetry of special projections

Along [001] 6m'm'	Along [100] p2m'g' a* = c	Along [210] p2m'g' a* = c
Origin at 0,0,z	Origin at x,0,0	Origin at x,x/2,1/12

$p6_1221'$

$6221'$

Hexagonal

No. 63.2.318

$p6_1221'$

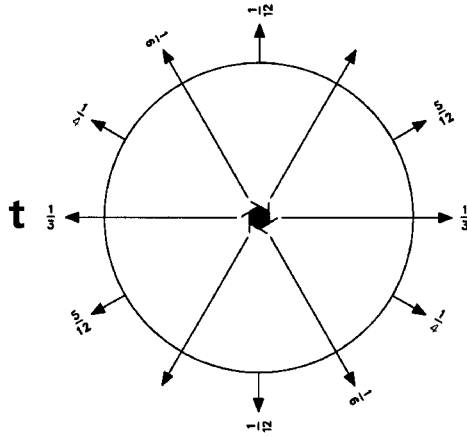

1'

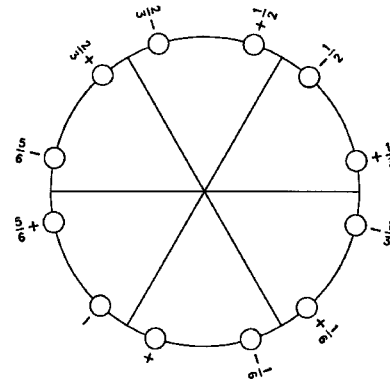

Origin on $2[100]1'$ at $6_1(2,1,1)11'$

Asymmetric unit $0 \leq z \leq 1/12$

Symmetry operations

For $1 +$ set

- | | | |
|--|---|---|
| (1) 1
$(1 0,0,0)$ | (2) $3^+ (0,0,1/3) \ 0,0,z$
$(3_z 0,0,1/3)$ | (3) $3^- (0,0,2/3) \ 0,0,z$
$(3_z^{-1} 0,0,2/3)$ |
| (4) $2 (0,0,1/2) \ 0,0,z$
$(2_z 0,0,1/2)$ | (5) $6^- (0,0,5/6) \ 0,0,z$
$(6_z^{-1} 0,0,5/6)$ | (6) $6^+ (0,0,1/6) \ 0,0,z$
$(6_z 0,0,1/6)$ |
| (7) $2 \ x,x,1/6$
$(2_{xy} 0,0,1/3)$ | (8) $2 \ x,0,0$
$(2_x 0,0,0)$ | (9) $2 \ 0,y,1/3$
$(2_y 0,0,2/3)$ |
| (10) $2 \ x,\bar{x},5/12$
$(2_3 0,0,5/6)$ | (11) $2 \ x,2x,1/4$
$(2_2 0,0,1/2)$ | (12) $2 \ 2x,x,1/12$
$(2_1 0,0,1/6)$ |

For $1' +$ set

- | | | |
|--|---|---|
| (1) $1'$
$(1 0,0,0)'$ | (2) $3^{+'} (0,0,1/3) \ 0,0,z$
$(3_z 0,0,1/3)'$ | (3) $3^{-'} (0,0,2/3) \ 0,0,z$
$(3_z^{-1} 0,0,2/3)'$ |
| (4) $2' (0,0,1/2) \ 0,0,z$
$(2_z 0,0,1/2)'$ | (5) $6^{-'} (0,0,5/6) \ 0,0,z$
$(6_z^{-1} 0,0,5/6)'$ | (6) $6^{+'} (0,0,1/6) \ 0,0,z$
$(6_z 0,0,1/6)'$ |
| (7) $2' \ x,x,1/6$
$(2_{xy} 0,0,1/3)'$ | (8) $2' \ x,0,0$
$(2_x 0,0,0)'$ | (9) $2' \ 0,y,1/3$
$(2_y 0,0,2/3)'$ |
| (10) $2' \ x,\bar{x},5/12$
$(2_3 0,0,5/6)'$ | (11) $2' \ x,2x,1/4$
$(2_2 0,0,1/2)'$ | (12) $2' \ 2x,x,1/12$
$(2_1 0,0,1/6)'$ |

Generators selected (1); t(0,0,1); (2); (4); (7); 1'

Positions

Multiplicity, Wyckoff letter, Site symmetry	Coordinates		
	1+	1' +	
12 c 11'	(1) x,y,z [0,0,0] (4) $\bar{x},\bar{y},z+1/2$ [0,0,0] (7) $y,x,\bar{z}+1/3$ [0,0,0] (10) $\bar{y},\bar{x},\bar{z}+5/6$ [0,0,0]	(2) $\bar{y},x-y,z+1/3$ [0,0,0] (5) $y,\bar{x}+y,z+5/6$ [0,0,0] (8) $x-y,\bar{y},\bar{z}$ [0,0,0] (11) $\bar{x}+y,y,\bar{z}+1/2$ [0,0,0]	(3) $\bar{x}+y,\bar{x},z+2/3$ [0,0,0] (6) $x-y,x,z+1/6$ [0,0,0] (9) $\bar{x},\bar{x}+y,\bar{z}+2/3$ [0,0,0] (12) $x,x-y,\bar{z}+1/6$ [0,0,0]
6 b ..21'	$x,2x,1/4$ [0,0,0] $\bar{x},2\bar{x},3/4$ [0,0,0]	$2\bar{x},\bar{x},7/12$ [0,0,0] $2x,x,1/12$ [0,0,0]	$x,\bar{x},11/12$ [0,0,0] $\bar{x},x,5/12$ [0,0,0]
6 a .2.1'	$x,0,0$ [0,0,0] $\bar{x},0,1/2$ [0,0,0]	$0,x,1/3$ [0,0,0] $0,\bar{x},5/6$ [0,0,0]	$\bar{x},\bar{x},2/3$ [0,0,0] $x,x,1/6$ [0,0,0]

Symmetry of special projections

Along [001] 6mm1'	Along [100] p2mg1'	Along [210] p2mg1'
Origin at 0,0,z	$a^* = c$ Origin at x,0,0	$a^* = c$ Origin at x,x/2,1/12

$p6_12'2'$

$62'2'$

Hexagonal

No. 63.3.319

$p6_12'2'$

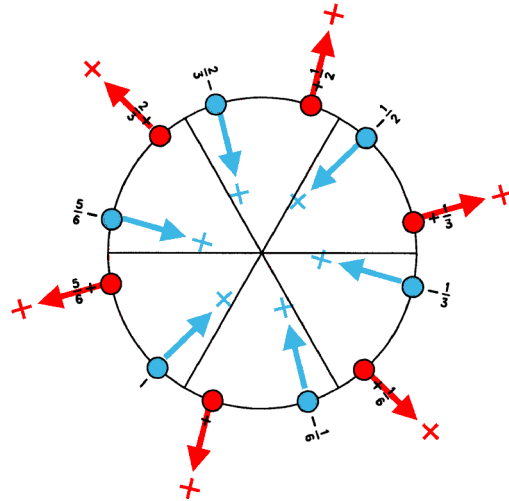
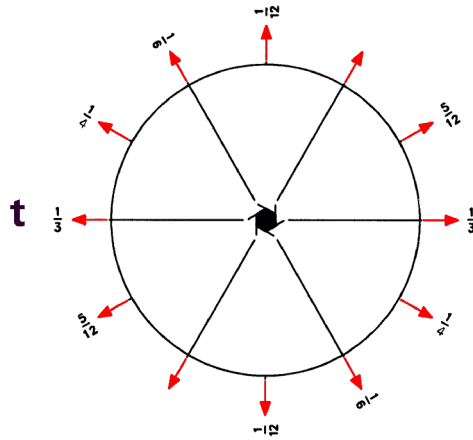

Origin on $2'[100]$ at $6_1(2',1,1)1$

Asymmetric unit $0 \leq z \leq 1/12$

Symmetry operations

- | | | |
|--|---|---|
| (1) 1
(1 0,0,0) | (2) 3^+ (0,0,1/3) 0,0,z
(3_z 0,0,1/3) | (3) 3^- (0,0,2/3) 0,0,z
(3_z^{-1} 0,0,2/3) |
| (4) 2 (0,0,1/2) 0,0,z
(2_z 0,0,1/2) | (5) 6^- (0,0,5/6) 0,0,z
(6_z^{-1} 0,0,5/6) | (6) 6^+ (0,0,1/6) 0,0,z
(6_z 0,0,1/6) |
| (7) $2'$ $x,x,1/6$
(2_{xy} 0,0,1/3)' | (8) $2'$ $x,0,0$
(2_x 0,0,0)' | (9) $2'$ $0,y,1/3$
(2_y 0,0,2/3)' |
| (10) $2'$ $x,\bar{x},5/12$
(2_3 0,0,5/6)' | (11) $2'$ $x,2x,1/4$
(2_2 0,0,1/2)' | (12) $2'$ $2x,x,1/12$
(2_1 0,0,1/6)' |

Generators selected (1); $t(0,0,1)$; (2); (4); (7)

Positions

	Coordinates		
Multiplicity, Wyckoff letter, Site symmetry			
12 c 1	(1) x,y,z [u,v,w]	(2) $\bar{y},x-y,z+1/3$ [$\bar{v},u-v,w$]	(3) $\bar{x}+y,\bar{x},z+2/3$ [$\bar{u}+v,\bar{u},w$]
	(4) $\bar{x},\bar{y},z+1/2$ [\bar{u},\bar{v},w]	(5) $y,\bar{x}+y,z+5/6$ [$v,\bar{u}+v,w$]	(6) $x-y,x,z+1/6$ [$u-v,u,w$]
	(7) $y,x,\bar{z}+1/3$ [\bar{v},\bar{u},w]	(8) $x-y,\bar{y},\bar{z}$ [$\bar{u}+v,v,w$]	(9) $\bar{x},\bar{x}+y,\bar{z}+2/3$ [$u,u-v,w$]
	(10) $\bar{y},\bar{x},\bar{z}+5/6$ [v,u,w]	(11) $\bar{x}+y,y,\bar{z}+1/2$ [$u-v,\bar{v},w$]	(12) $x,x-y,\bar{z}+1/6$ [$\bar{u},\bar{u}+v,w$]
6 b ..2'	$x,2x,1/4$ [u,0,w]	$2\bar{x},\bar{x},7/12$ [0,u,w]	$x,\bar{x},11/12$ [\bar{u},\bar{u},w]
	$\bar{x},2\bar{x},3/4$ [$\bar{u},0,w$]	$2x,x,1/12$ [0, \bar{u},w]	$\bar{x},x,5/12$ [u,u,w]
6 a .2'	$x,0,0$ [u,2u,w]	$0,x,1/3$ [2 \bar{u},\bar{u},w]	$\bar{x},\bar{x},2/3$ [u, \bar{u},w]
	$\bar{x},0,1/2$ [$\bar{u},2\bar{u},w$]	$0,\bar{x},5/6$ [2u,u,w]	$x,x,1/6$ [\bar{u},u,w]

Symmetry of special projections

Along [001] 6mm	Along [100] $p2'mg'$ $a^* = c$	Along [210] $p2'mg'$ $a^* = c$
Origin at 0,0,z	Origin at x,0,0	Origin at x,x/2,1/12

$p6_1'2'2'$

$6'2'2'$

Hexagonal

No. 63.4.320

$p6_1'2'2'$

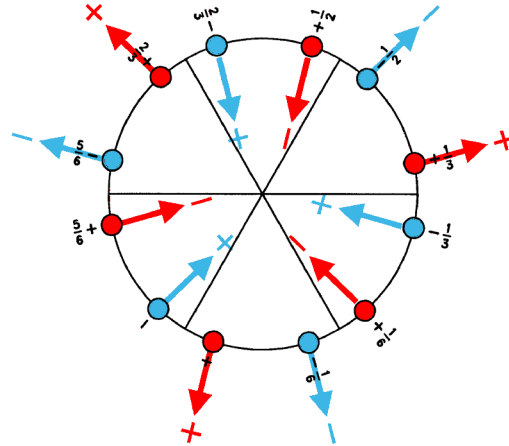
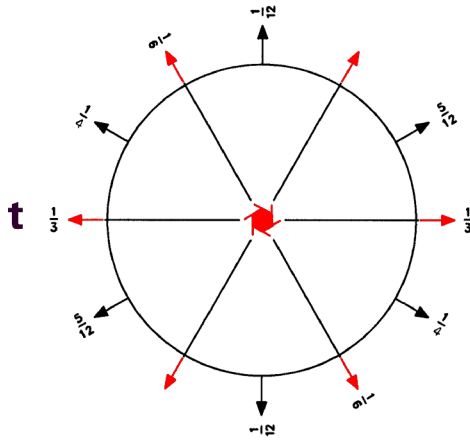

Origin on $2'[100]$ at $6_1'(2',1,1)1$

Asymmetric unit $0 \leq z \leq 1/12$

Symmetry operations

- | | | |
|--|--|---|
| (1) 1
(1 0,0,0) | (2) $3^+ (0,0,1/3) \ 0,0,z$
(3_z 0,0,1/3) | (3) $3^- (0,0,2/3) \ 0,0,z$
(3_z^{-1} 0,0,2/3) |
| (4) $2' (0,0,1/2) \ 0,0,z$
(2_z 0,0,1/2)' | (5) $6^- (0,0,5/6) \ 0,0,z$
(6_z^{-1} 0,0,5/6)' | (6) $6^+ (0,0,1/6) \ 0,0,z$
(6_z 0,0,1/6)' |
| (7) $2' \ x,x,1/6$
(2_{xy} 0,0,1/3)' | (8) $2' \ x,0,0$
(2_x 0,0,0)' | (9) $2' \ 0,y,1/3$
(2_y 0,0,2/3)' |
| (10) $2 \ x,\bar{x},5/12$
(2_3 0,0,5/6) | (11) $2 \ x,2x,1/4$
(2_2 0,0,1/2) | (12) $2 \ 2x,x,1/12$
(2_1 0,0,1/6) |

Generators selected (1); t(0,0,1); (2); (4); (7)

Positions

	Coordinates		
Multiplicity, Wyckoff letter, Site symmetry			
12 c 1	(1) x,y,z [u,v,w]	(2) $\bar{y},x-y,z+1/3$ [$\bar{v},u-v,w$]	(3) $\bar{x}+y,\bar{x},z+2/3$ [$\bar{u}+v,\bar{u},w$]
	(4) $\bar{x},\bar{y},z+1/2$ [u,v, \bar{w}]	(5) $y,\bar{x}+y,z+5/6$ [$\bar{v},u-v,\bar{w}$]	(6) x-y,x,z+1/6 [$\bar{u}+v,\bar{u},\bar{w}$]
	(7) y,x, $\bar{z}+1/3$ [\bar{v},\bar{u},w]	(8) x-y, \bar{y},\bar{z} [$\bar{u}+v,v,w$]	(9) $\bar{x},\bar{x}+y,\bar{z}+2/3$ [u,u-v,w]
	(10) $\bar{y},\bar{x},\bar{z}+5/6$ [\bar{v},\bar{u},\bar{w}]	(11) $\bar{x}+y,y,\bar{z}+1/2$ [$\bar{u}+v,v,\bar{w}$]	(12) x,x-y, $\bar{z}+1/6$ [u,u-v, \bar{w}]
6 b ..2	x,2x,1/4 [u,2u,0]	2 $\bar{x},\bar{x},7/12$ [2 $\bar{u},\bar{u},0$]	x, $\bar{x},11/12$ [u, $\bar{u},0$]
	$\bar{x},2\bar{x},3/4$ [u,2u,0]	2x,x,1/12 [2 $\bar{u},\bar{u},0$]	$\bar{x},x,5/12$ [u, $\bar{u},0$]
6 a .2'	x,0,0 [u,2u,w]	0,x,1/3 [2 \bar{u},\bar{u},w]	$\bar{x},\bar{x},2/3$ [u, \bar{u},w]
	$\bar{x},0,1/2$ [u,2u, \bar{w}]	0, $\bar{x},5/6$ [2 \bar{u},\bar{u},\bar{w}]	x,x,1/6 [u, \bar{u},\bar{w}]

Symmetry of special projections

Along [001] 6'mm'	Along [100] p2'm'g a* = c	Along [210] p2'm'g a* = c
Origin at 0,0,z	Origin at x,0,0	Origin at x,x/2,1/12

$p6_222$

622

Hexagonal

No. 64.1.321

$p6_222$

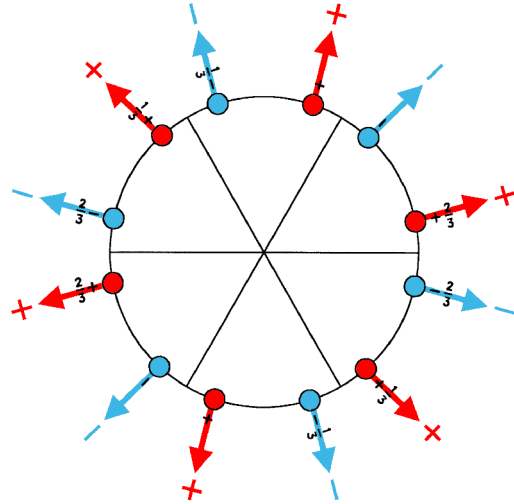
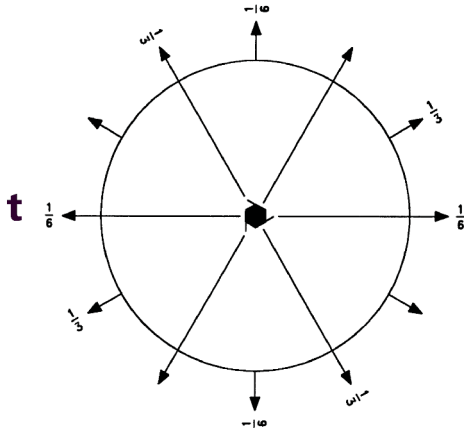

Origin on 222 at $6_2(2,1,1)(1,2,1)$

Asymmetric unit $0 \leq x: 0 \leq z \leq 1/6$

Symmetry operations

- | | | |
|---|---|---|
| (1) 1
(1 0,0,0) | (2) 3^+ (0,0,2/3) 0,0,z
(3_z 0,0,2/3) | (3) 3^- (0,0,1/3) 0,0,z
(3_z^{-1} 0,0,1/3) |
| (4) 2 0,0,z
(2_z 0,0,0) | (5) 6^- (0,0,2/3) 0,0,z
(6_z^{-1} 0,0,2/3) | (6) 6^+ (0,0,1/3) 0,0,z
(6_z 0,0,1/3) |
| (7) 2 x,x,1/3
(2_{xy} 0,0,2/3) | (8) 2 x,0,0
(2_x 0,0,0) | (9) 2 0,y,1/6
(2_y 0,0,1/3) |
| (10) 2 x, \bar{x} ,1/3
(2_3 0,0,2/3) | (11) 2 x,2x,0
(2_2 0,0,0) | (12) 2 2x,x,1/6
(2_1 0,0,1/3) |

Generators selected (1); t(0,0,1); (2); (4); (7)

Positions

	Coordinates		
Multiplicity, Wyckoff letter, Site symmetry			
12 h 1	(1) x,y,z [u,v,w]	(2) $\bar{y},x-y,z+2/3$ [$\bar{v},u-v,w$]	(3) $\bar{x}+y,\bar{x},z+1/3$ [$\bar{u}+v,\bar{u},w$]
	(4) \bar{x},\bar{y},z [\bar{u},\bar{v},w]	(5) $y,\bar{x}+y,z+2/3$ [$v,\bar{u}+v,w$]	(6) $x-y,x,z+1/3$ [$u-v,u,w$]
	(7) $y,x,\bar{z}+2/3$ [v,u,\bar{w}]	(8) $x-y,\bar{y},\bar{z}$ [$u-v,\bar{v},\bar{w}$]	(9) $\bar{x},\bar{x}+y,\bar{z}+1/3$ [$\bar{u},\bar{u}+v,\bar{w}$]
	(10) $\bar{y},\bar{x},\bar{z}+2/3$ [\bar{v},\bar{u},\bar{w}]	(11) $\bar{x}+y,y,\bar{z}$ [$\bar{u}+v,v,\bar{w}$]	(12) $x,x-y,\bar{z}+1/3$ [$u,u-v,\bar{w}$]
6 g ..2	x,2x,1/2 [u,2u,0]	2 $\bar{x},\bar{x},1/6$ [2 $\bar{u},\bar{u},0$]	x, $\bar{x},5/6$ [u, $\bar{u},0$]
	$\bar{x},2\bar{x},1/2$ [$\bar{u},2\bar{u},0$]	2x,x,1/6 [2u,u,0]	$\bar{x},x,5/6$ [$\bar{u},u,0$]
6 f ..2	x,2x,0 [u,2u,0]	2 $\bar{x},\bar{x},2/3$ [2 $\bar{u},\bar{u},0$]	x, $\bar{x},1/3$ [u, $\bar{u},0$]
	$\bar{x},2\bar{x},0$ [$\bar{u},2\bar{u},0$]	2x,x,2/3 [2u,u,0]	$\bar{x},x,1/3$ [$\bar{u},u,0$]
6 e .2.	x,0,1/2 [u,0,0]	0,x,1/6 [0,u,0]	$\bar{x},\bar{x},5/6$ [$\bar{u},\bar{u},0$]
	$\bar{x},0,1/2$ [$\bar{u},0,0$]	0, $\bar{x},1/6$ [0, $\bar{u},0$]	x,x,5/6 [u,u,0]
6 d .2.	x,0,0 [u,0,0]	0,x,2/3 [0,u,0]	$\bar{x},\bar{x},1/3$ [$\bar{u},\bar{u},0$]
	$\bar{x},0,0$ [$\bar{u},0,0$]	0, $\bar{x},2/3$ [0, $\bar{u},0$]	x,x,1/3 [u,u,0]
6 c 2..	0,0,z [0,0,w]	0,0,z+2/3 [0,0,w]	0,0,z+1/3 [0,0,w]
	0,0, $\bar{z}+2/3$ [0,0, \bar{w}]	0,0, \bar{z} [0,0, \bar{w}]	0,0, $\bar{z}+1/3$ [0,0, \bar{w}]
3 b 222	0,0,1/2 [0,0,0]	0,0,1/6 [0,0,0]	0,0,5/6 [0,0,0]
3 a 222	0,0,0 [0,0,0]	0,0,2/3 [0,0,0]	0,0,1/3 [0,0,0]

Symmetry of special projectionsAlong [001] $6m'm'$

Origin at 0,0,z

Along [100] $p2m'm'$ $a^* = c$

Origin at x,0,0

Along [210] $p2m'm'$ $a^* = c$

Origin at x,x/2,1/6

$p6_2221'$

$6221'$

Hexagonal

No. 64.2.322

$p6_2221'$

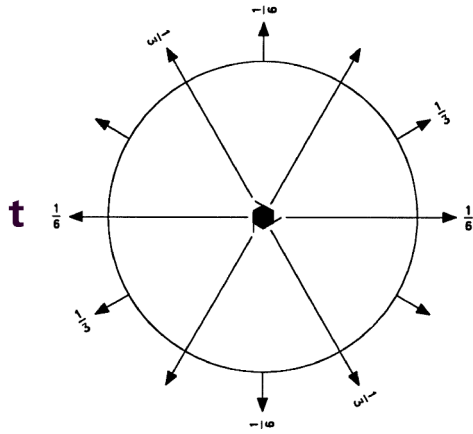

1'

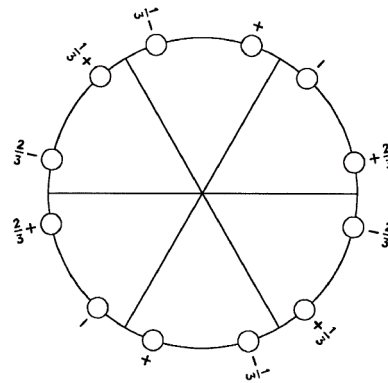

Origin on $2221'$ at $6_2(2,1,1)(1,2,1)1'$

Asymmetric unit $0 \leq x: 0 \leq z \leq 1/6$

Symmetry operations

For 1 + set

- | | | |
|---|---|---|
| (1) 1
(1 0,0,0) | (2) 3^+ (0,0,2/3) 0,0,z
(3_z 0,0,2/3) | (3) 3^- (0,0,1/3) 0,0,z
(3_z^{-1} 0,0,1/3) |
| (4) 2 0,0,z
(2_z 0,0,0) | (5) 6^- (0,0,2/3) 0,0,z
(6_z^{-1} 0,0,2/3) | (6) 6^+ (0,0,1/3) 0,0,z
(6_z 0,0,1/3) |
| (7) 2 x,x,1/3
(2_{xy} 0,0,2/3) | (8) 2 x,0,0
(2_x 0,0,0) | (9) 2 0,y,1/6
(2_y 0,0,1/3) |
| (10) 2 x, \bar{x} ,1/3
(2_3 0,0,2/3) | (11) 2 x,2x,0
(2_2 0,0,0) | (12) 2 2x,x,1/6
(2_1 0,0,1/3) |

For 1' + set

- | | | |
|---|---|---|
| (1) 1'
(1 0,0,0)' | (2) $3^{+'}$ (0,0,2/3) 0,0,z
(3_z 0,0,2/3)' | (3) $3^{-'}$ (0,0,1/3) 0,0,z
(3_z^{-1} 0,0,1/3)' |
| (4) 2' 0,0,z
(2_z 0,0,0)' | (5) $6^{-'}$ (0,0,2/3) 0,0,z
(6_z^{-1} 0,0,2/3)' | (6) $6^{+'}$ (0,0,1/3) 0,0,z
(6_z 0,0,1/3)' |
| (7) 2' x,x,1/3
(2_{xy} 0,0,2/3)' | (8) 2' x,0,0
(2_x 0,0,0)' | (9) 2' 0,y,1/6
(2_y 0,0,1/3)' |
| (10) 2' x, \bar{x} ,1/3
(2_3 0,0,2/3)' | (11) 2' x,2x,0
(2_2 0,0,0)' | (12) 2' 2x,x,1/6
(2_1 0,0,1/3)' |

Generators selected (1); t(0,0,1); (2); (4); (7); 1'

Positions

Multiplicity, Wyckoff letter, Site symmetry	Coordinates		
	1+	1'+	
12 h 11'	(1) x,y,z [0,0,0] (4) \bar{x},\bar{y},z [0,0,0] (7) y,x, $\bar{z}+2/3$ [0,0,0] (10) $\bar{y},\bar{x},\bar{z}+2/3$ [0,0,0]	(2) $\bar{y},x-y,z+2/3$ [0,0,0] (5) y, $\bar{x}+y,z+2/3$ [0,0,0] (8) x-y, \bar{y},\bar{z} [0,0,0] (11) $\bar{x}+y,y,\bar{z}$ [0,0,0]	(3) $\bar{x}+y,\bar{x},z+1/3$ [0,0,0] (6) x-y,x,z+1/3 [0,0,0] (9) $\bar{x},\bar{x}+y,\bar{z}+1/3$ [0,0,0] (12) x,x-y, $\bar{z}+1/3$ [0,0,0]
6 g ..21'	x,2x,1/2 [0,0,0] $\bar{x},2\bar{x},1/2$ [0,0,0]	2 $\bar{x},\bar{x},1/6$ [0,0,0] 2x,x,1/6 [0,0,0]	x, $\bar{x},5/6$ [0,0,0] $\bar{x},x,5/6$ [0,0,0]
6 f ..21'	x,2x,0 [0,0,0] $\bar{x},2\bar{x},0$ [0,0,0]	2 $\bar{x},\bar{x},2/3$ [0,0,0] 2x,x,2/3 [0,0,0]	x, $\bar{x},1/3$ [0,0,0] $\bar{x},x,1/3$ [0,0,0]
6 e .2.1'	x,0,1/2 [0,0,0] $\bar{x},0,1/2$ [0,0,0]	0,x,1/6 [0,0,0] 0, $\bar{x},1/6$ [0,0,0]	$\bar{x},\bar{x},5/6$ [0,0,0] x,x,5/6 [0,0,0]
6 d .2.1'	x,0,0 [0,0,0] $\bar{x},0,0$ [0,0,0]	0,x,2/3 [0,0,0] 0, $\bar{x},2/3$ [0,0,0]	$\bar{x},\bar{x},1/3$ [0,0,0] x,x,1/3 [0,0,0]
6 c 2..1'	0,0,z [0,0,0] 0,0, $\bar{z}+2/3$ [0,0,0]	0,0,z+2/3 [0,0,0] 0,0, \bar{z} [0,0,0]	0,0,z+1/3 [0,0,0] 0,0, $\bar{z}+1/3$ [0,0,0]
3 b 2221'	0,0,1/2 [0,0,0]	0,0,1/6 [0,0,0]	0,0,5/6 [0,0,0]
3 a 2221'	0,0,0 [0,0,0]	0,0,2/3 [0,0,0]	0,0,1/3 [0,0,0]

Symmetry of special projectionsAlong [001] $6mm1'$

Origin at 0,0,z

Along [100] $p2mm1'$ $a^* = c$

Origin at x,0,0

Along [210] $p2mm1'$ $a^* = c$

Origin at x,x/2,1/6

$p6_22'2'$

$62'2'$

Hexagonal

No. 64.3.323

$p6_22'2'$

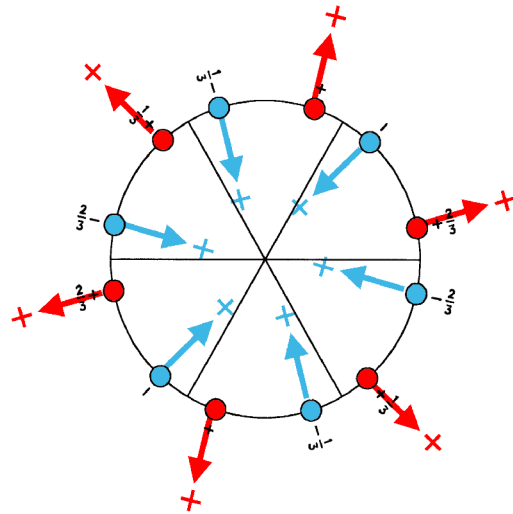
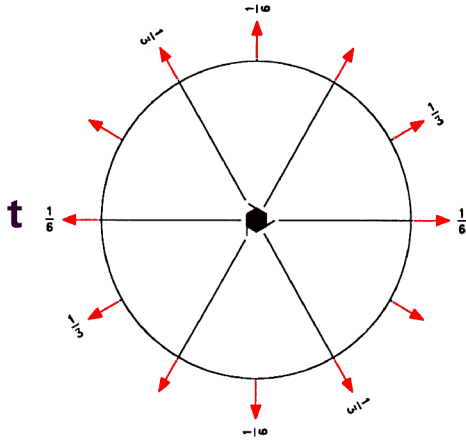

Origin on $2'2'2'$ at $6_2(2',1,1)(1,2',1)$

Asymmetric unit $0 \leq x: 0 \leq z \leq 1/6$

Symmetry operations

- | | | |
|---|---|---|
| (1) 1
(1 0,0,0) | (2) 3^+ (0,0,2/3) 0,0,z
(3_z 0,0,2/3) | (3) 3^- (0,0,1/3) 0,0,z
(3_z^{-1} 0,0,1/3) |
| (4) 2 0,0,z
(2_z 0,0,0) | (5) 6^- (0,0,2/3) 0,0,z
(6_z^{-1} 0,0,2/3) | (6) 6^+ (0,0,1/3) 0,0,z
(6_z 0,0,1/3) |
| (7) $2'$ x,x,1/3
(2_{xy} 0,0,2/3)' | (8) $2'$ x,0,0
(2_x 0,0,0)' | (9) $2'$ 0,y,1/6
(2_y 0,0,1/3)' |
| (10) $2'$ x, \bar{x} ,1/3
(2_3 0,0,2/3)' | (11) $2'$ x,2x,0
(2_2 0,0,0)' | (12) $2'$ 2x,x,1/6
(2_1 0,0,1/3)' |

Generators selected (1); $t(0,0,1)$; (2); (4); (7)

Positions

	Coordinates		
Multiplicity, Wyckoff letter, Site symmetry			
12 h 1	(1) x,y,z [u,v,w]	(2) $\bar{y},x-y,z+2/3$ [$\bar{v},u-v,w$]	(3) $\bar{x}+y,\bar{x},z+1/3$ [$\bar{u}+v,\bar{u},w$]
	(4) \bar{x},\bar{y},z [\bar{u},\bar{v},w]	(5) $y,\bar{x}+y,z+2/3$ [$v,\bar{u}+v,w$]	(6) $x-y,x,z+1/3$ [u-v,u,w]
	(7) $y,x,\bar{z}+2/3$ [\bar{v},\bar{u},w]	(8) $x-y,\bar{y},\bar{z}$ [$\bar{u}+v,v,w$]	(9) $\bar{x},\bar{x}+y,\bar{z}+1/3$ [u,u-v,w]
	(10) $\bar{y},\bar{x},\bar{z}+2/3$ [v,u,w]	(11) $\bar{x}+y,y,\bar{z}$ [u-v, \bar{v},w]	(12) $x,x-y,\bar{z}+1/3$ [$\bar{u},\bar{u}+v,w$]
6 g ..2'	$x,2x,1/2$ [u,0,w]	$2\bar{x},\bar{x},1/6$ [0,u,w]	$x,\bar{x},5/6$ [\bar{u},\bar{u},w]
	$\bar{x},2\bar{x},1/2$ [$\bar{u},0,w$]	$2x,x,1/6$ [0, \bar{u},w]	$\bar{x},x,5/6$ [u,u,w]
6 f ..2'	$x,2x,0$ [u,0,w]	$2\bar{x},\bar{x},2/3$ [0,u,w]	$x,\bar{x},1/3$ [\bar{u},\bar{u},w]
	$\bar{x},2\bar{x},0$ [$\bar{u},0,w$]	$2x,x,2/3$ [0, \bar{u},w]	$\bar{x},x,1/3$ [u,u,w]
6 e .2'	$x,0,1/2$ [u,2u,w]	$0,x,1/6$ [2 \bar{u},\bar{u},w]	$\bar{x},\bar{x},5/6$ [u, \bar{u},w]
	$\bar{x},0,1/2$ [$\bar{u},2\bar{u},w$]	$0,\bar{x},1/6$ [2u,u,w]	$x,x,5/6$ [\bar{u},u,w]
6 d .2'	$x,0,0$ [u,2u,w]	$0,x,2/3$ [2 \bar{u},\bar{u},w]	$\bar{x},\bar{x},1/3$ [u, \bar{u},w]
	$\bar{x},0,0$ [$\bar{u},2\bar{u},w$]	$0,\bar{x},2/3$ [2u,u,w]	$x,x,1/3$ [\bar{u},u,w]
6 c 2..	$0,0,z$ [0,0,w]	$0,0,z+2/3$ [0,0,w]	$0,0,z+1/3$ [0,0,w]
	$0,0,\bar{z}+2/3$ [0,0,w]	$0,0,\bar{z}$ [0,0,w]	$0,0,\bar{z}+1/3$ [0,0,w]
3 b 22'2'	$0,0,1/2$ [0,0,w]	$0,0,1/6$ [0,0,w]	$0,0,5/6$ [0,0,w]
3 a 22'2'	$0,0,0$ [0,0,w]	$0,0,2/3$ [0,0,w]	$0,0,1/3$ [0,0,w]

Continued

No. 64.3.323

$p6_2 2'2'$

Symmetry of special projections

Along [001] $6mm$

Origin at $0,0,z$

Along [100] $p2'mm'$

$a^* = c$

Origin at $x,0,0$

Along [210] $p2'mm'$

$a^* = c$

Origin at $x,x/2,1/6$

$p6_2'2'2'$

$6'2'2'$

Hexagonal

No. 64.4.324

$p6_2'2'2'$

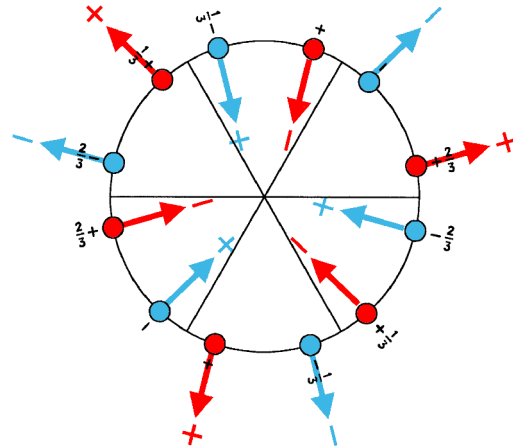
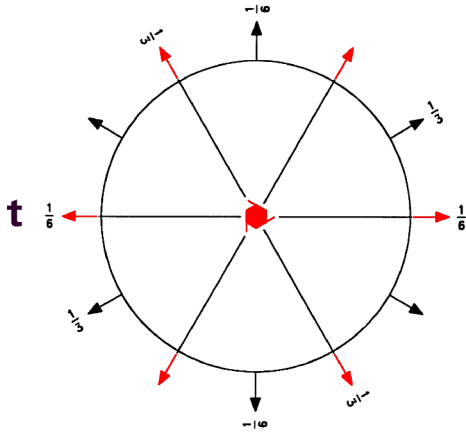

Origin on $2'2'2'$ at $6_2'(2',1,1)(1,2,1)$

Asymmetric unit $0 \leq x: 0 \leq z \leq 1/6$

Symmetry operations

- | | | |
|---|--|---|
| (1) 1
(1 0,0,0) | (2) 3^+ (0,0,2/3) 0,0,z
(3_z 0,0,2/3) | (3) 3^- (0,0,1/3) 0,0,z
(3_z^{-1} 0,0,1/3) |
| (4) $2'$ 0,0,z
(2_z 0,0,0)' | (5) 6^- (0,0,2/3) 0,0,z
(6_z^{-1} 0,0,2/3)' | (6) 6^+ (0,0,1/3) 0,0,z
(6_z 0,0,1/3)' |
| (7) $2'$ x,x,1/3
(2_{xy} 0,0,2/3)' | (8) $2'$ x,0,0
(2_x 0,0,0)' | (9) $2'$ 0,y,1/6
(2_y 0,0,1/3)' |
| (10) 2 x, \bar{x} ,1/3
(2_3 0,0,2/3) | (11) 2 x,2x,0
(2_2 0,0,0) | (12) 2 2x,x,1/6
(2_1 0,0,1/3) |

Generators selected (1); $t(0,0,1)$; (2); (4); (7)

Positions

	Coordinates		
Multiplicity, Wyckoff letter, Site symmetry			
12 h 1	(1) x,y,z [u,v,w]	(2) $\bar{y},x-y,z+2/3$ [$\bar{v},u-v,w$]	(3) $\bar{x}+y,\bar{x},z+1/3$ [$\bar{u}+v,\bar{u},w$]
	(4) \bar{x},\bar{y},z [u,v, \bar{w}]	(5) $y,\bar{x}+y,z+2/3$ [$\bar{v},u-v,\bar{w}$]	(6) $x-y,x,z+1/3$ [$\bar{u}+v,\bar{u},\bar{w}$]
	(7) $y,x,\bar{z}+2/3$ [\bar{v},\bar{u},w]	(8) $x-y,\bar{y},\bar{z}$ [$\bar{u}+v,v,w$]	(9) $\bar{x},\bar{x}+y,\bar{z}+1/3$ [u,u-v,w]
	(10) $\bar{y},\bar{x},\bar{z}+2/3$ [\bar{v},\bar{u},\bar{w}]	(11) $\bar{x}+y,y,\bar{z}$ [$\bar{u}+v,v,\bar{w}$]	(12) $x,x-y,\bar{z}+1/3$ [u,u-v, \bar{w}]
6 g ..2	$x,2x,1/2$ [u,2u,0]	$2\bar{x},\bar{x},1/6$ [2 $\bar{u},\bar{u},0$]	$x,\bar{x},5/6$ [u, $\bar{u},0$]
	$\bar{x},2\bar{x},1/2$ [u,2u,0]	$2x,x,1/6$ [2 $\bar{u},\bar{u},0$]	$\bar{x},x,5/6$ [u, $\bar{u},0$]
6 f ..2	$x,2x,0$ [u,2u,0]	$2\bar{x},\bar{x},2/3$ [2 $\bar{u},\bar{u},0$]	$x,\bar{x},1/3$ [u, $\bar{u},0$]
	$\bar{x},2\bar{x},0$ [u,2u,0]	$2x,x,2/3$ [2 $\bar{u},\bar{u},0$]	$\bar{x},x,1/3$ [u, $\bar{u},0$]
6 e .2'	$x,0,1/2$ [u,2u,w]	$0,x,1/6$ [2 \bar{u},\bar{u},w]	$\bar{x},\bar{x},5/6$ [u, \bar{u},w]
	$\bar{x},0,1/2$ [u,2u, \bar{w}]	$0,\bar{x},1/6$ [2 \bar{u},\bar{u},\bar{w}]	$x,x,5/6$ [u, \bar{u},w]
6 d .2'	$x,0,0$ [u,2u,w]	$0,x,2/3$ [2 \bar{u},\bar{u},w]	$\bar{x},\bar{x},1/3$ [u, \bar{u},w]
	$\bar{x},0,0$ [u,2u, \bar{w}]	$0,\bar{x},2/3$ [2 \bar{u},\bar{u},\bar{w}]	$x,x,1/3$ [u, \bar{u},w]
6 c 2'..	$0,0,z$ [u,v,0]	$0,0,z+2/3$ [$\bar{v},u-v,0$]	$0,0,z+1/3$ [$\bar{u}+v,\bar{u},0$]
	$0,0,\bar{z}+2/3$ [$\bar{v},\bar{u},0$]	$0,0,\bar{z}$ [$\bar{u}+v,v,0$]	$0,0,\bar{z}+1/3$ [u,u-v,0]
3 b 2'2'2	$0,0,1/2$ [u,2u,0]	$0,0,1/6$ [2 $\bar{u},\bar{u},0$]	$0,0,5/6$ [u, $\bar{u},0$]
3 a 2'2'2	$0,0,0$ [u,2u,0]	$0,0,2/3$ [2 $\bar{u},\bar{u},0$]	$0,0,1/3$ [u, $\bar{u},0$]

Continued

No. 64.4.324

$p6_2'2'$

Symmetry of special projections

Along [001] $6'm'm'$

Origin at 0,0,z

Along [100] $p2m'm'$

$a^* = c$

Origin at x,0,0

Along [210] $p2mm$

$a^* = c$

Origin at x,x/2,1/6

$p_{2c}6_222$

$6221'$

Hexagonal

No. 64.5.325

$p_{2c}6_222$

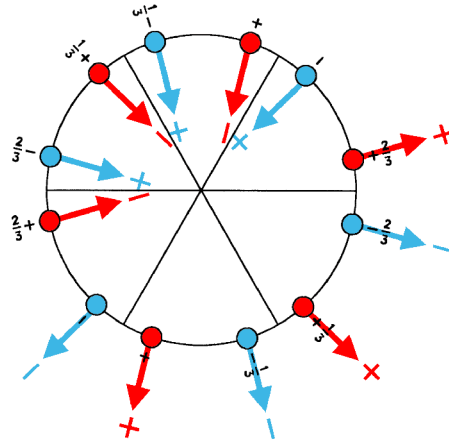
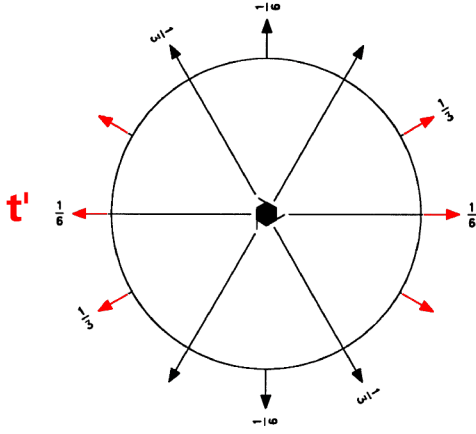

Origin on $22'2'$ at $6_2(2,1,1)(1,2',1)$

Asymmetric unit $0 \leq x: 0 \leq z \leq 1/6$

Symmetry operations

For $(0,0,0)$ + set

- | | | |
|---|--|--|
| (1) 1
(1 0,0,0) | (2) 3^+ $(0,0,2/3)$ $0,0,z$
(3_z 0,0,2/3) | (3) 3^- $(0,0,1/3)$ $0,0,z$
(3_z^{-1} 0,0,1/3)' |
| (4) $2'$ $0,0,z$
(2_z 0,0,0)' | (5) 6^- $(0,0,2/3)$ $0,0,z$
(6_z^{-1} 0,0,2/3)' | (6) 6^+ $(0,0,1/3)$ $0,0,z$
(6_z 0,0,1/3) |
| (7) 2 $x,x,1/3$
(2_{xy} 0,0,2/3) | (8) 2 $x,0,0$
(2_x 0,0,0) | (9) $2'$ $0,y,1/6$
(2_y 0,0,1/3)' |
| (10) $2'$ $x,\bar{x},1/3$
(2_3 0,0,2/3)' | (11) $2'$ $x,2x,0$
(2_2 0,0,0)' | (12) 2 $2x,x,1/6$
(2_1 0,0,1/3) |

For $(0,0,1)'$ + set

- | | | |
|---|---|---|
| (1) t' $(0,0,1)$
(1 0,0,1)' | (2) $3^{+'}$ $(0,0,5/3)$ $0,0,z$
(3_z 0,0,5/3)' | (3) 3^- $(0,0,4/3)$ $0,0,z$
(3_z^{-1} 0,0,4/3) |
| (4) 2 $(0,0,1)$ $0,0,z$
(2_z 0,0,1) | (5) 6^- $(0,0,5/3)$ $0,0,z$
(6_z^{-1} 0,0,5/3) | (6) $6^{+'}$ $(0,0,4/3)$ $0,0,z$
(6_z 0,0,4/3)' |
| (7) $2'$ $x,x,5/6$
(2_{xy} 0,0,5/3)' | (8) $2'$ $x,0,1/2$
(2_x 0,0,1)' | (9) 2 $0,y,2/3$
(2_y 0,0,4/3) |
| (10) 2 $x,\bar{x},5/6$
(2_3 0,0,5/3) | (11) 2 $x,2x,1/2$
(2_2 0,0,1) | (12) $2'$ $2x,x,2/3$
(2_1 0,0,4/3)' |

Generators selected (1); $t(0,0,1)'$; (2); (4); (7)

Positions

Multiplicity, Wyckoff letter, Site symmetry	Coordinates		
		(0,0,0)+	(0,0,1)' +
12 h 1	(1) $x,y,z [u,v,w]$	(2) $\bar{y},x-y,z+2/3 [\bar{v},u-v,w]$	(3) $\bar{x}+y,\bar{x},z+1/3 [u-v,u,\bar{w}]$
	(4) $\bar{x},\bar{y},z [u,v,\bar{w}]$	(5) $y,\bar{x}+y,z+2/3 [\bar{v},u-v,\bar{w}]$	(6) $x-y,x,z+1/3 [u-v,u,w]$
	(7) $y,x,\bar{z}+2/3 [v,u,\bar{w}]$	(8) $x-y,\bar{y},\bar{z} [u-v,\bar{v},\bar{w}]$	(9) $\bar{x},\bar{x}+y,\bar{z}+1/3 [u,u-v,w]$
	(10) $\bar{y},\bar{x},\bar{z}+2/3 [v,u,w]$	(11) $\bar{x}+y,y,\bar{z} [u-v,\bar{v},w]$	(12) $x,x-y,\bar{z}+1/3 [u,u-v,\bar{w}]$
6 g ..2	$x,2x,1/2 [u,2u,0]$	$2\bar{x},\bar{x},1/6 [2u,u,0]$	$x,\bar{x},5/6 [\bar{u},u,0]$
	$\bar{x},2\bar{x},1/2 [u,2u,0]$	$2x,x,1/6 [2u,u,0]$	$\bar{x},x,5/6 [\bar{u},u,0]$
6 f ..2'	$x,2x,0 [u,0,w]$	$2\bar{x},\bar{x},2/3 [0,u,w]$	$x,\bar{x},1/3 [u,u,\bar{w}]$
	$\bar{x},2\bar{x},0 [u,0,\bar{w}]$	$2x,x,2/3 [0,u,\bar{w}]$	$\bar{x},x,1/3 [u,u,w]$
6 e .2'	$x,0,1/2 [u,2u,w]$	$0,x,1/6 [2u,u,\bar{w}]$	$\bar{x},\bar{x},5/6 [\bar{u},u,\bar{w}]$
	$\bar{x},0,1/2 [u,2u,\bar{w}]$	$0,\bar{x},1/6 [2u,u,w]$	$x,x,5/6 [\bar{u},u,w]$
6 d .2.	$x,0,0 [u,0,0]$	$0,x,2/3 [0,u,0]$	$\bar{x},\bar{x},1/3 [u,u,0]$
	$\bar{x},0,0 [u,0,0]$	$0,\bar{x},2/3 [0,u,0]$	$x,x,1/3 [u,u,0]$
6 c 2'..	$0,0,z [u,v,0]$	$0,0,z+2/3 [\bar{v},u-v,0]$	$0,0,z+1/3 [u-v,u,0]$
	$0,0,\bar{z}+2/3 [v,u,0]$	$0,0,\bar{z} [u-v,\bar{v},0]$	$0,0,\bar{z}+1/3 [u,u-v,0]$
3 b 2'2'2	$0,0,1/2 [u,2u,0]$	$0,0,1/6 [2u,u,0]$	$0,0,5/6 [\bar{u},u,0]$
3 a 2'2'2'	$0,0,0 [u,0,0]$	$0,0,2/3 [0,u,0]$	$0,0,1/3 [u,u,0]$

Symmetry of special projections

Along [001] $6mm1'$	Along [100] $p_{2a^*}2'mm'$	Along [210] $p_{2a^*}2m'm'$
	$a^* = c$	$a^* = c$
Origin at 0,0,z	Origin at x,0,0	Origin at x,x/2,1/6

$p_{2c}6_2'22'$

6221'

Hexagonal

No. 64.6.326

$p_{2c}6_2'22'$

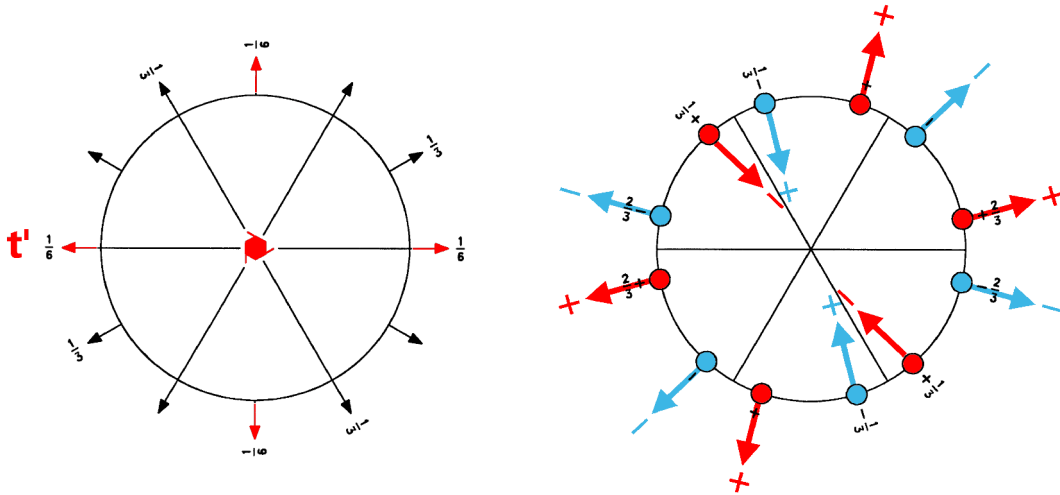

Origin on 222 at $6_2'(2,1,1)(1,2,1)$

Asymmetric unit $0 \leq x: 0 \leq z \leq 1/6$

Symmetry operations

- | | | |
|---|--|---|
| (1) 1
(1 0,0,0) | (2) $3^+(0,0,2/3) \ 0,0,z$
(3_z 0,0,2/3) | (3) $3^-(0,0,1/3) \ 0,0,z$
(3_z^{-1} 0,0,1/3)' |
| (4) $2 \ 0,0,z$
(2_z 0,0,0) | (5) $6^-(0,0,2/3) \ 0,0,z$
(6_z^{-1} 0,0,2/3) | (6) $6^+(0,0,1/3) \ 0,0,z$
(6_z 0,0,1/3)' |
| (7) $2 \ x,x,1/3$
(2_{xy} 0,0,2/3) | (8) $2 \ x,0,0$
(2_x 0,0,0) | (9) $2' \ 0,y,1/6$
(2_y 0,0,1/3)' |
| (10) $2 \ x,\bar{x},1/3$
(2_3 0,0,2/3) | (11) $2 \ x,2x,0$
(2_2 0,0,0) | (12) $2' \ 2x,x,1/6$
(2_1 0,0,1/3)' |

For $(0,0,1)'$ + set

- | | | |
|---|---|---|
| (1) $t' (0,0,1)$
(1 0,0,1)' | (2) $3^{+'} (0,0,5/3) \ 0,0,z$
(3_z 0,0,5/3)' | (3) $3^- (0,0,4/3) \ 0,0,z$
(3_z^{-1} 0,0,4/3) |
| (4) $2' (0,0,1) \ 0,0,z$
(2_z 0,0,1)' | (5) $6^{+'} (0,0,5/3) \ 0,0,z$
(6_z^{-1} 0,0,5/3)' | (6) $6^+ (0,0,4/3) \ 0,0,z$
(6_z 0,0,4/3) |
| (7) $2' \ x,x,5/6$
(2_{xy} 0,0,5/3)' | (8) $2' \ x,0,1/2$
(2_x 0,0,1)' | (9) $2 \ 0,y,2/3$
(2_y 0,0,4/3) |
| (10) $2' \ x,\bar{x},5/6$
(2_3 0,0,5/3)' | (11) $2' \ x,2x,1/2$
(2_2 0,0,1)' | (12) $2 \ 2x,x,2/3$
(2_1 0,0,4/3) |

Generators selected (1); $t(0,0,1)'$; (2); (4); (7)

Positions

Multiplicity, Wyckoff letter, Site symmetry	Coordinates	(0,0,0)+ (0,0,1)' +		
		(0,0,0)+	(0,0,1)'	(0,0,0)+ (0,0,1)' +
12 h 1	(1) x,y,z [u,v,w]	(2) $\bar{y},x-y,z+2/3$ [$\bar{v},u-v,w$]	(3) $\bar{x}+y,\bar{x},z+1/3$ [u-v,u, \bar{w}]	
	(4) \bar{x},\bar{y},z [\bar{u},\bar{v},w]	(5) $y,\bar{x}+y,z+2/3$ [v, $\bar{u}+v,w$]	(6) $x-y,x,z+1/3$ [$\bar{u}+v,\bar{u},\bar{w}$]	
	(7) $y,x,\bar{z}+2/3$ [v,u, \bar{w}]	(8) $x-y,\bar{y},\bar{z}$ [u-v, \bar{v},\bar{w}]	(9) $\bar{x},\bar{x}+y,\bar{z}+1/3$ [u,u-v,w]	
	(10) $\bar{y},\bar{x},\bar{z}+2/3$ [\bar{v},\bar{u},\bar{w}]	(11) $\bar{x}+y,y,\bar{z}$ [$\bar{u}+v,v,\bar{w}$]	(12) $x,x-y,\bar{z}+1/3$ [$\bar{u},\bar{u}+v,w$]	
6 g ..2'	$x,2x,1/2$ [u,0,w]	$2\bar{x},\bar{x},1/6$ [0, \bar{u},\bar{w}]	$x,\bar{x},5/6$ [u,u, \bar{w}]	
	$\bar{x},2\bar{x},1/2$ [$\bar{u},0,w$]	$2x,x,1/6$ [0,u, \bar{w}]	$\bar{x},x,5/6$ [\bar{u},\bar{u},\bar{w}]	
6 f ..2	$x,2x,0$ [u,2u,0]	$2\bar{x},\bar{x},2/3$ [2 $\bar{u},\bar{u},0$]	$x,\bar{x},1/3$ [$\bar{u},u,0$]	
	$\bar{x},2\bar{x},0$ [2 $\bar{u},\bar{u},0$]	$2x,x,2/3$ [u,2u,0]	$\bar{x},x,1/3$ [u, $\bar{u},0$]	
6 e .2'	$x,0,1/2$ [u,2u,w]	$0,x,1/6$ [2u,u, \bar{w}]	$\bar{x},\bar{x},5/6$ [\bar{u},u,\bar{w}]	
	$\bar{x},0,1/2$ [$\bar{u},2\bar{u},w$]	$0,\bar{x},1/6$ [2 \bar{u},\bar{u},\bar{w}]	$x,x,5/6$ [u, \bar{u},\bar{w}]	
6 d .2.	$x,0,0$ [u,0,0]	$0,x,2/3$ [0,u,0]	$\bar{x},\bar{x},1/3$ [u,u,0]	
	$\bar{x},0,0$ [$\bar{u},0,0$]	$0,\bar{x},2/3$ [0, $\bar{u},0$]	$x,x,1/3$ [$\bar{u},\bar{u},0$]	
6 c 2..	$0,0,z$ [0,0,w]	$0,0,z+2/3$ [0,0,w]	$0,0,z+1/3$ [0,0,w]	
	$0,0,\bar{z}+2/3$ [0,0, \bar{w}]	$0,0,\bar{z}$ [0,0, \bar{w}]	$0,0,\bar{z}+1/3$ [0,0, \bar{w}]	
3 b 22'2'	$0,0,1/2$ [0,0,w]	$0,0,1/6$ [0,0, \bar{w}]	$0,0,5/6$ [0,0, \bar{w}]	
3 a 222	$0,0,0$ [0,0,0]	$0,0,2/3$ [0,0,0]	$0,0,1/3$ [0,0,0]	

Continued

No. 64.6.326

$p_{2c} 6_2 '22'$

Symmetry of special projections

Along [001] $6mm1'$

Origin at 0,0,z

Along [100] $p_{2a^*} 2mm$

$a^* = c$

Origin at x,0,0

Along [210] $p_{2a^*} 2'm'm$

$a^* = c$

Origin at x,x/2,1/6

$p6_3 22$

622

Hexagonal

No. 65.1.327

$p6_3 22$

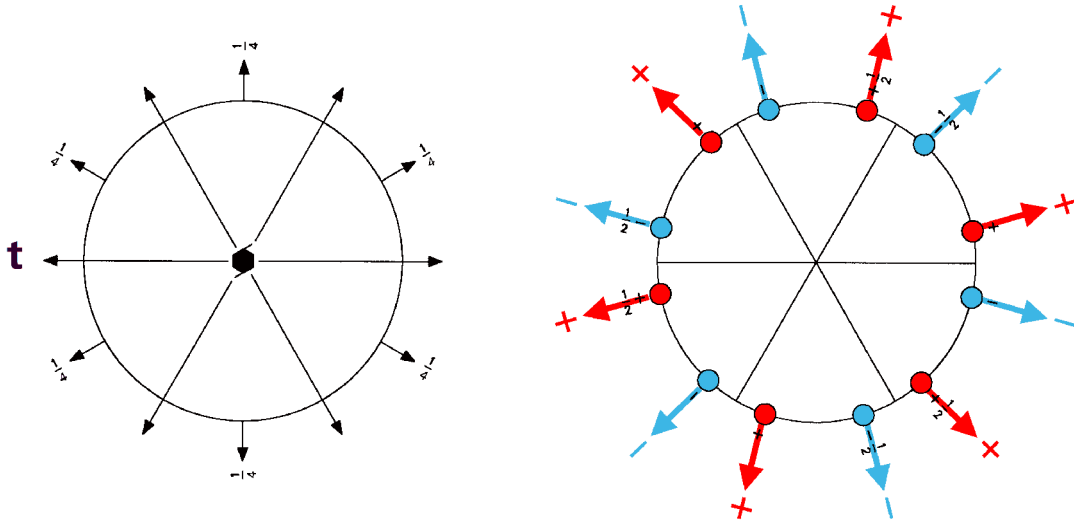

Origin at 321 at $6_3 21$

Asymmetric unit $0 \leq x$; $0 \leq y$; $0 \leq z \leq 1/4$

Symmetry operations

- | | | |
|---|---|--|
| (1) 1
(1 0,0,0) | (2) 3^+ 0,0,z
(3_z 0,0,0) | (3) 3^- 0,0,z
(3_z^{-1} 0,0,0) |
| (4) 2 (0,0,1/2) 0,0,z
(2_z 0,0,1/2) | (5) 6^- (0,0,1/2) 0,0,z
(6_z^{-1} 0,0,1/2) | (6) 6^+ (0,0,1/2) 0,0,z
(6_z 0,0,1/2) |
| (7) 2 x,x,0
(2_{xy} 0,0,0) | (8) 2 x,0,0
(2_x 0,0,0) | (9) 2 0,y,0
(2_y 0,0,0) |
| (10) 2 x, \bar{x} ,1/4
(2_3 0,0,1/2) | (11) 2 x,2x,1/4
(2_2 0,0,1/2) | (12) 2 2x,x,1/4
(2_1 0,0,1/2) |

Generators selected (1); t(0,0,1); (2); (4); (7)

Positions

	Coordinates		
Multiplicity, Wyckoff letter, Site symmetry			
12 f 1	(1) x,y,z [u,v,w]	(2) $\bar{y},x-y,z$ [$\bar{v},u-v,w$]	(3) $\bar{x}+y,\bar{x},z$ [$\bar{u}+v,\bar{u},w$]
	(4) $\bar{x},\bar{y},z+1/2$ [\bar{u},\bar{v},w]	(5) $y,\bar{x}+y,z+1/2$ [$v,\bar{u}+v,w$]	(6) $x-y,x,z+1/2$ [$u-v,u,w$]
	(7) y,x,\bar{z} [v,u,\bar{w}]	(8) $x-y,\bar{y},\bar{z}$ [$u-v,\bar{v},\bar{w}$]	(9) $\bar{x},\bar{x}+y,\bar{z}$ [$\bar{u},\bar{u}+v,\bar{w}$]
	(10) $\bar{y},\bar{x},\bar{z}+1/2$ [\bar{v},\bar{u},\bar{w}]	(11) $\bar{x}+y,y,\bar{z}+1/2$ [$\bar{u}+v,v,\bar{w}$]	(12) $x,x-y,\bar{z}+1/2$ [$u,u-v,\bar{w}$]
6 e ..2	$x,2x,1/4$ [$u,2u,0$]	$2\bar{x},\bar{x},1/4$ [$2\bar{u},\bar{u},0$]	$x,\bar{x},1/4$ [$u,\bar{u},0$]
	$\bar{x},2\bar{x},3/4$ [$\bar{u},2\bar{u},0$]	$2x,x,3/4$ [$2u,u,0$]	$\bar{x},x,3/4$ [$\bar{u},u,0$]
6 d .2.	$x,0,0$ [$u,0,0$]	$0,x,0$ [$0,u,0$]	$\bar{x},\bar{x},0$ [$\bar{u},\bar{u},0$]
	$\bar{x},0,1/2$ [$\bar{u},0,0$]	$0,\bar{x},1/2$ [$0,\bar{u},0$]	$x,x,1/2$ [$u,u,0$]
4 c 3..	$0,0,z$ [$0,0,w$]	$0,0,z+1/2$ [$0,0,w$]	
	$0,0,\bar{z}$ [$0,0,\bar{w}$]	$0,0,\bar{z}+1/2$ [$0,0,\bar{w}$]	
2 b 3.2	$0,0,1/4$ [$0,0,0$]	$0,0,3/4$ [$0,0,0$]	
2 a 32.	$0,0,0$ [$0,0,0$]	$0,0,1/2$ [$0,0,0$]	

Symmetry of special projections

Along [001] 6m'm'	Along [100] p2m'g'	Along [210] p2m'g'
Origin at 0,0,z	$\mathbf{a}^* = \mathbf{c}$ Origin at x,0,0	$\mathbf{a}^* = \mathbf{c}$ Origin at x,x/2,1/4

$p6_3221'$

$6221'$

Hexagonal

No. 65.2.328

$p6_3221'$

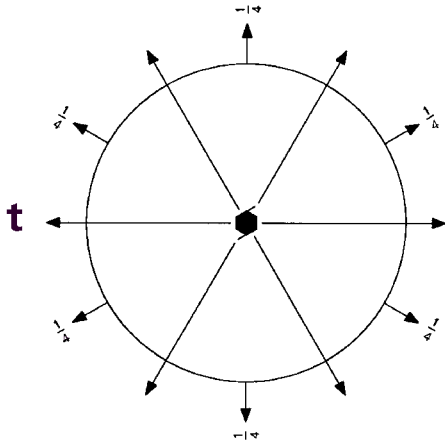

1'

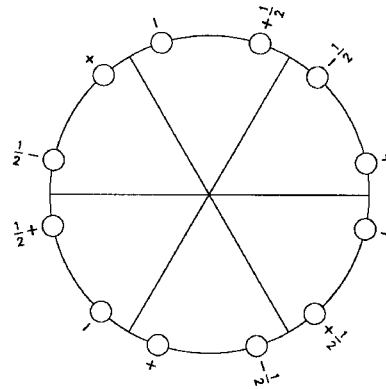

Origin at $3211'$ at $6_3211'$

Asymmetric unit $0 \leq x$; $0 \leq y$; $0 \leq z \leq 1/4$

Symmetry operations

For 1 + set

- | | | |
|---|---|--|
| (1) 1
(1 0,0,0) | (2) 3^+ 0,0,z
(3_z 0,0,0) | (3) 3^- 0,0,z
(3_z^{-1} 0,0,0) |
| (4) 2 (0,0,1/2) 0,0,z
(2_z 0,0,1/2) | (5) 6^- (0,0,1/2) 0,0,z
(6_z^{-1} 0,0,1/2) | (6) 6^+ (0,0,1/2) 0,0,z
(6_z 0,0,1/2) |
| (7) 2 x,x,0
(2_{xy} 0,0,0) | (8) 2 x,0,0
(2_x 0,0,0) | (9) 2 0,y,0
(2_y 0,0,0) |
| (10) 2 x, \bar{x} ,1/4
(2_3 0,0,1/2) | (11) 2 x,2x,1/4
(2_2 0,0,1/2) | (12) 2 2x,x,1/4
(2_1 0,0,1/2) |

For 1' + set

- | | | |
|---|---|--|
| (1) 1'
(1 0,0,0)' | (2) $3^{+'}$ 0,0,z
(3_z 0,0,0)' | (3) $3^{-'}$ 0,0,z
(3_z^{-1} 0,0,0)' |
| (4) $2'$ (0,0,1/2) 0,0,z
(2_z 0,0,1/2)' | (5) $6^{-'}$ (0,0,1/2) 0,0,z
(6_z^{-1} 0,0,1/2)' | (6) $6^{+'}$ (0,0,1/2) 0,0,z
(6_z 0,0,1/2)' |
| (7) $2'$ x,x,0
(2_{xy} 0,0,0)' | (8) $2'$ x,0,0
(2_x 0,0,0)' | (9) $2'$ 0,y,0
(2_y 0,0,0)' |
| (10) $2'$ x, \bar{x} ,1/4
(2_3 0,0,1/2)' | (11) $2'$ x,2x,1/4
(2_2 0,0,1/2)' | (12) $2'$ 2x,x,1/4
(2_1 0,0,1/2)' |

Generators selected (1); $t(0,0,1)$; (2); (4); (7); $1'$

Positions

Multiplicity, Wyckoff letter, Site symmetry	Coordinates		
		1+	1'+
12 f 11'	(1) x,y,z [0,0,0] (4) $\bar{x},\bar{y},z+1/2$ [0,0,0] (7) y,x,\bar{z} [0,0,0] (10) $\bar{y},\bar{x},\bar{z}+1/2$ [0,0,0]	(2) $\bar{y},x-y,z$ [0,0,0] (5) $y,\bar{x}+y,z+1/2$ [0,0,0] (8) $x-y,\bar{y},\bar{z}$ [0,0,0] (11) $\bar{x}+y,y,\bar{z}+1/2$ [0,0,0]	(3) $\bar{x}+y,\bar{x},z$ [0,0,0] (6) $x-y,x,z+1/2$ [0,0,0] (9) $\bar{x},\bar{x}+y,\bar{z}$ [0,0,0] (12) $x,x-y,\bar{z}+1/2$ [0,0,0]
6 e ..21'	$x,2x,1/4$ [0,0,0] $\bar{x},2\bar{x},3/4$ [0,0,0]	$2\bar{x},\bar{x},1/4$ [0,0,0] $2x,x,3/4$ [0,0,0]	$x,\bar{x},1/4$ [0,0,0] $\bar{x},x,3/4$ [0,0,0]
6 d .2.1'	$x,0,0$ [0,0,0] $\bar{x},0,1/2$ [0,0,0]	$0,x,0$ [0,0,0] $0,\bar{x},1/2$ [0,0,0]	$\bar{x},\bar{x},0$ [0,0,0] $x,x,1/2$ [0,0,0]
4 c 3..1'	$0,0,z$ [0,0,0] $0,0,\bar{z}$ [0,0,0]	$0,0,z+1/2$ [0,0,0] $0,0,\bar{z}+1/2$ [0,0,0]	
2 b 3.21'	$0,0,1/4$ [0,0,0]	$0,0,3/4$ [0,0,0]	
2 a 32.1'	$0,0,0$ [0,0,0]	$0,0,1/2$ [0,0,0]	

Symmetry of special projections

Along [001] $6mm1'$ Origin at 0,0,z	Along [100] $p2mg1'$ $a^* = c$ Origin at $x,0,0$	Along [210] $p2mg1'$ $a^* = c$ Origin at $x,x/2,1/4$
--	--	--

$p6_32'2'$

$62'2'$

Hexagonal

No. 65.3.329

$p6_32'2'$

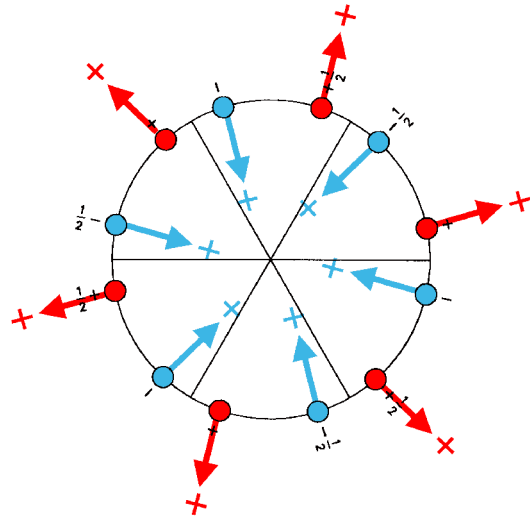
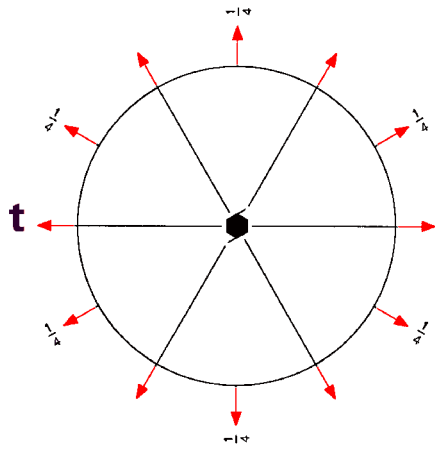

Origin at $32'1$ at $6_32'1$

Asymmetric unit $0 \leq x$; $0 \leq y$; $0 \leq z \leq 1/4$

Symmetry operations

- | | | |
|---|---|--|
| (1) 1
(1 0,0,0) | (2) 3^+ 0,0,z
(3_z 0,0,0) | (3) 3^- 0,0,z
(3_z^{-1} 0,0,0) |
| (4) 2 (0,0,1/2) 0,0,z
(2_z 0,0,1/2) | (5) 6^- (0,0,1/2) 0,0,z
(6_z^{-1} 0,0,1/2) | (6) 6^+ (0,0,1/2) 0,0,z
(6_z 0,0,1/2) |
| (7) $2'$ x,x,0
(2_{xy} 0,0,0)' | (8) $2'$ x,0,0
(2_x 0,0,0)' | (9) $2'$ 0,y,0
(2_y 0,0,0)' |
| (10) $2'$ x, \bar{x} ,1/4
(2_3 0,0,1/2)' | (11) $2'$ x,2x,1/4
(2_2 0,0,1/2)' | (12) $2'$ 2x,x,1/4
(2_1 0,0,1/2)' |

Generators selected (1); $t(0,0,1)$; (2); (4); (7)

Positions

	Coordinates		
Multiplicity, Wyckoff letter, Site symmetry			
12 f 1	(1) x,y,z [u,v,w]	(2) $\bar{y},x-y,z$ [$\bar{v},u-v,w$]	(3) $\bar{x}+y,\bar{x},z$ [$\bar{u}+v,\bar{u},w$]
	(4) $\bar{x},\bar{y},z+1/2$ [\bar{u},\bar{v},w]	(5) $y,\bar{x}+y,z+1/2$ [$v,\bar{u}+v,w$]	(6) $x-y,x,z+1/2$ [u-v,u,w]
	(7) y,x,\bar{z} [\bar{v},\bar{u},w]	(8) $x-y,\bar{y},\bar{z}$ [$\bar{u}+v,v,w$]	(9) $\bar{x},\bar{x}+y,\bar{z}$ [u,u-v,w]
	(10) $\bar{y},\bar{x},\bar{z}+1/2$ [v,u,w]	(11) $\bar{x}+y,y,\bar{z}+1/2$ [u-v, \bar{v},w]	(12) $x,x-y,\bar{z}+1/2$ [$\bar{u},\bar{u}+v,w$]
6 e ..2'	$x,2x,1/4$ [u,0,w]	$2\bar{x},\bar{x},1/4$ [0,u,w]	$x,\bar{x},1/4$ [\bar{u},\bar{u},w]
	$\bar{x},2\bar{x},3/4$ [$\bar{u},0,w$]	$2x,x,3/4$ [0, \bar{u},w]	$\bar{x},x,3/4$ [u,u,w]
6 d .2'	$x,0,0$ [u,2u,w]	$0,x,0$ [2 \bar{u},\bar{u},w]	$\bar{x},\bar{x},0$ [u, \bar{u},w]
	$\bar{x},0,1/2$ [$\bar{u},2\bar{u},w$]	$0,\bar{x},1/2$ [2u,u,w]	$x,x,1/2$ [\bar{u},u,w]
4 c 3..	$0,0,z$ [0,0,w]	$0,0,z+1/2$ [0,0,w]	
	$0,0,\bar{z}$ [0,0,w]	$0,0,\bar{z}+1/2$ [0,0,w]	
2 b 3.2'	$0,0,1/4$ [0,0,w]	$0,0,3/4$ [0,0,w]	
2 a 32'	$0,0,0$ [0,0,w]	$0,0,1/2$ [0,0,w]	

Symmetry of special projections

Along [001] 6mm	Along [100] $\rho 2'mg'$	Along [210] $\rho 2'mg'$
Origin at 0,0,z	$\mathbf{a}^* = \mathbf{c}$ Origin at x,0,0	$\mathbf{a}^* = \mathbf{c}$ Origin at x,x/2,1/4

$p6_3'2'2'$

$6'2'2'$

Hexagonal

No. 65.4.330

$p6_3'2'2'$

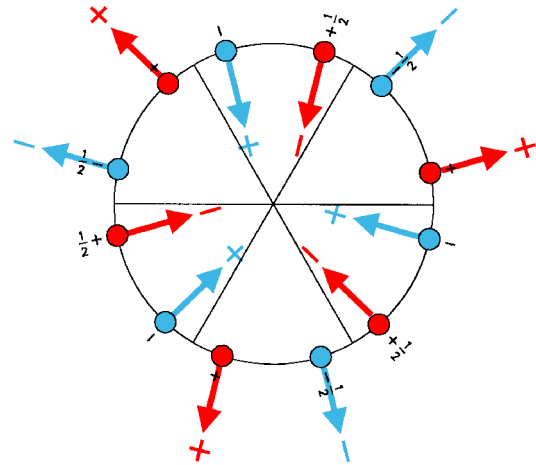
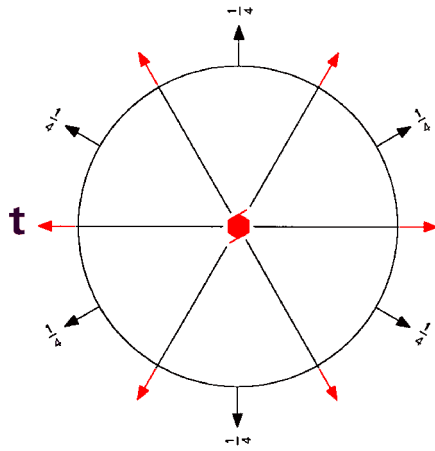

Origin at $32'1'$ at $6_3'2'1'$

Asymmetric unit $0 \leq x$; $0 \leq y$; $0 \leq z \leq 1/4$

Symmetry operations

- | | | |
|---|--|---|
| (1) 1
(1 0,0,0) | (2) 3^+ 0,0,z
(3_z 0,0,0) | (3) 3^- 0,0,z
(3_z^{-1} 0,0,0) |
| (4) $2'$ (0,0,1/2) 0,0,z
(2_z 0,0,1/2)' | (5) 6^- (0,0,1/2) 0,0,z
(6_z^{-1} 0,0,1/2)' | (6) 6^+ (0,0,1/2) 0,0,z
(6_z 0,0,1/2)' |
| (7) $2'$ x,x,0
(2_{xy} 0,0,0)' | (8) $2'$ x,0,0
(2_x 0,0,0)' | (9) $2'$ 0,y,0
(2_y 0,0,0)' |
| (10) 2 x, \bar{x} ,1/4
(2_3 0,0,1/2) | (11) 2 x,2x,1/4
(2_2 0,0,1/2) | (12) 2 2x,x,1/4
(2_1 0,0,1/2) |

Generators selected (1); $t(0,0,1)$; (2); (4); (7)

Positions

	Coordinates		
Multiplicity, Wyckoff letter, Site symmetry			
12 f 1	(1) x,y,z [u,v,w]	(2) $\bar{y},x-y,z$ [$\bar{v},u-v,w$]	(3) $\bar{x}+y,\bar{x},z$ [$\bar{u}+v,\bar{u},w$]
	(4) $\bar{x},\bar{y},z+1/2$ [u,v,\bar{w}]	(5) $y,\bar{x}+y,z+1/2$ [$\bar{v},u-v,\bar{w}$]	(6) $x-y,x,z+1/2$ [$\bar{u}+v,\bar{u},\bar{w}$]
	(7) y,x,\bar{z} [\bar{v},\bar{u},w]	(8) $x-y,\bar{y},\bar{z}$ [$\bar{u}+v,v,w$]	(9) $\bar{x},\bar{x}+y,\bar{z}$ [$u,u-v,w$]
	(10) $\bar{y},\bar{x},\bar{z}+1/2$ [\bar{v},\bar{u},\bar{w}]	(11) $\bar{x}+y,y,\bar{z}+1/2$ [$\bar{u}+v,v,\bar{w}$]	(12) $x,x-y,\bar{z}+1/2$ [$u,u-v,\bar{w}$]
6 e ..2	$x,2x,1/4$ [$u,2u,0$]	$2\bar{x},\bar{x},1/4$ [$2\bar{u},\bar{u},0$]	$x,\bar{x},1/4$ [$u,\bar{u},0$]
	$\bar{x},2\bar{x},3/4$ [$u,2u,0$]	$2x,x,3/4$ [$2\bar{u},\bar{u},0$]	$\bar{x},x,3/4$ [$u,\bar{u},0$]
6 d .2'	$x,0,0$ [$u,2u,w$]	$0,x,0$ [$2\bar{u},\bar{u},w$]	$\bar{x},\bar{x},0$ [u,\bar{u},w]
	$\bar{x},0,1/2$ [$u,2u,\bar{w}$]	$0,\bar{x},1/2$ [$2\bar{u},\bar{u},\bar{w}$]	$x,x,1/2$ [u,\bar{u},\bar{w}]
4 c 3..	$0,0,z$ [$0,0,w$]	$0,0,z+1/2$ [$0,0,\bar{w}$]	
	$0,0,\bar{z}$ [$0,0,w$]	$0,0,\bar{z}+1/2$ [$0,0,\bar{w}$]	
2 b 3.2	$0,0,1/4$ [$0,0,0$]	$0,0,3/4$ [$0,0,0$]	
2 a 32'	$0,0,0$ [$0,0,w$]	$0,0,1/2$ [$0,0,\bar{w}$]	

Symmetry of special projections

Along [001] $6'm'm$	Along [100] $p2'm'g$	Along [210] $p2mg$
Origin at $0,0,z$	$a^* = c$ Origin at $x,0,0$	$a^* = c$ Origin at $x,x/2,1/4$

$p6_422$

622

Hexagonal

No. 66.1.331

$p6_422$

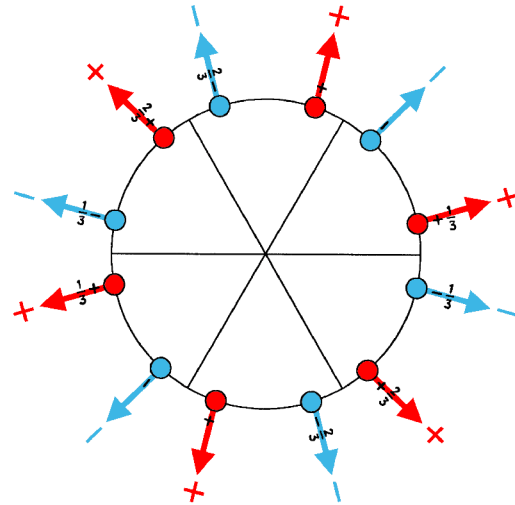
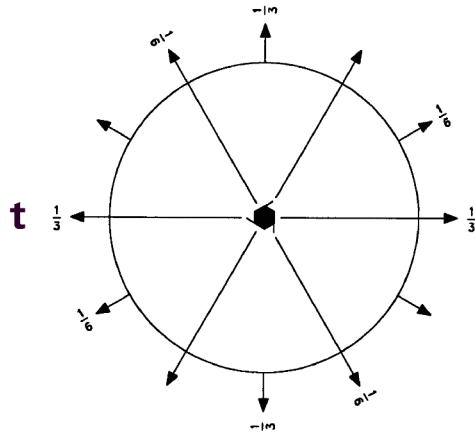

Origin on 222 at $6_4(2,1,1)(1,2,1)$

Asymmetric unit $0 \leq x: 0 \leq z \leq 1/6$

Symmetry operations

- | | | |
|---|---|---|
| (1) 1
(1 0,0,0) | (2) 3^+ (0,0,1/3) 0,0,z
(3_z 0,0,1/3) | (3) 3^- (0,0,2/3) 0,0,z
(3_z^{-1} 0,0,2/3) |
| (4) 2 0,0,z
(2_z 0,0,0) | (5) 6^- (0,0,1/3) 0,0,z
(6_z^{-1} 0,0,1/3) | (6) 6^+ (0,0,2/3) 0,0,z
(6_z 0,0,2/3) |
| (7) 2 x,x,1/6
(2_{xy} 0,0,1/3) | (8) 2 x,0,0
(2_x 0,0,0) | (9) 2 0,y,1/3
(2_y 0,0,2/3) |
| (10) 2 x, \bar{x} ,1/6
(2_3 0,0,1/3) | (11) 2 x,2x,0
(2_2 0,0,0) | (12) 2 2x,x,1/3
(2_1 0,0,2/3) |

Generators selected (1); t(0,0,1); (2); (4); (7)

Positions

	Coordinates		
Multiplicity, Wyckoff letter, Site symmetry			
12 h 1	(1) x,y,z [u,v,w]	(2) $\bar{y},x-y,z+1/3$ [$\bar{v},u-v,w$]	(3) $\bar{x}+y,\bar{x},z+2/3$ [$\bar{u}+v,\bar{u},w$]
	(4) \bar{x},\bar{y},z [\bar{u},\bar{v},w]	(5) $y,\bar{x}+y,z+1/3$ [$v,\bar{u}+v,w$]	(6) $x-y,x,z+2/3$ [$u-v,u,w$]
	(7) $y,x,\bar{z}+1/3$ [v,u,\bar{w}]	(8) $x-y,\bar{y},\bar{z}$ [$u-v,\bar{v},\bar{w}$]	(9) $\bar{x},\bar{x}+y,\bar{z}+2/3$ [$\bar{u},\bar{u}+v,\bar{w}$]
	(10) $\bar{y},\bar{x},\bar{z}+1/3$ [\bar{v},\bar{u},\bar{w}]	(11) $\bar{x}+y,y,\bar{z}$ [$\bar{u}+v,v,\bar{w}$]	(12) $x,x-y,\bar{z}+2/3$ [$u,u-v,\bar{w}$]
6 g ..2	$x,2x,1/2$ [u,2u,0]	$2\bar{x},\bar{x},5/6$ [$2\bar{u},\bar{u},0$]	$x,\bar{x},1/6$ [u, \bar{u} ,0]
	$\bar{x},2\bar{x},1/2$ [$\bar{u},2\bar{u},0$]	$2x,x,5/6$ [$2u,u,0$]	$\bar{x},x,1/6$ [$\bar{u},u,0$]
6 f ..2	$x,2x,0$ [u,2u,0]	$2\bar{x},\bar{x},1/3$ [$2\bar{u},\bar{u},0$]	$x,\bar{x},2/3$ [u, \bar{u} ,0]
	$\bar{x},2\bar{x},0$ [$\bar{u},2\bar{u},0$]	$2x,x,1/3$ [$2u,u,0$]	$\bar{x},x,2/3$ [$\bar{u},u,0$]
6 e .2.	$x,0,1/2$ [u,0,0]	$0,x,5/6$ [0,u,0]	$\bar{x},\bar{x},1/6$ [$\bar{u},\bar{u},0$]
	$\bar{x},0,1/2$ [$\bar{u},0,0$]	$0,\bar{x},5/6$ [0, \bar{u} ,0]	$x,x,1/6$ [u,u,0]
6 d .2.	$x,0,0$ [u,0,0]	$0,x,1/3$ [0,u,0]	$\bar{x},\bar{x},2/3$ [$\bar{u},\bar{u},0$]
	$\bar{x},0,0$ [$\bar{u},0,0$]	$0,\bar{x},1/3$ [0, \bar{u} ,0]	$x,x,2/3$ [u,u,0]
6 c 2..	$0,0,z$ [0,0,w]	$0,0,z+1/3$ [0,0,w]	$0,0,z+2/3$ [0,0,w]
	$0,0,\bar{z}+1/3$ [0,0, \bar{w}]	$0,0,\bar{z}$ [0,0, \bar{w}]	$0,0,\bar{z}+2/3$ [0,0, \bar{w}]
3 b 222	$0,0,1/2$ [0,0,0]	$0,0,5/6$ [0,0,0]	$0,0,1/6$ [0,0,0]
3 a 222	$0,0,0$ [0,0,0]	$0,0,1/3$ [0,0,0]	$0,0,2/3$ [0,0,0]

Symmetry of special projectionsAlong [001] $6m'm'$

Origin at 0,0,z

Along [100] $p2m'm'$ $a^* = c$

Origin at x,0,0

Along [210] $p2m'm'$ $a^* = c$

Origin at x,x/2,1/3

$p6_4221'$

$6221'$

Hexagonal

No. 66.2.332

$p6_4221'$

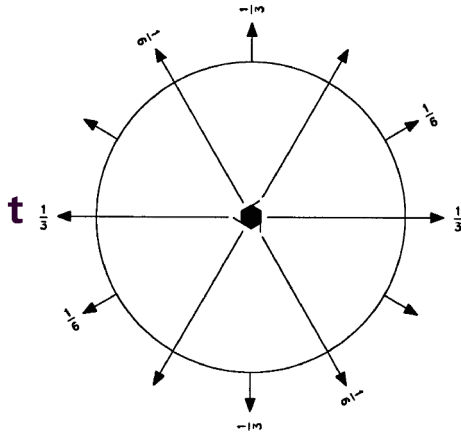

$1'$

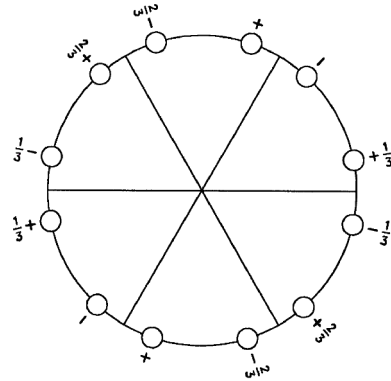

Origin on $2221'$ at $6_4(2,1,1)(1,2,1)1'$

Asymmetric unit $0 \leq x: 0 \leq z \leq 1/6$

Symmetry operations

For $1 + \text{set}$

- | | | |
|---|--|--|
| (1) 1
($1 0,0,0$) | (2) $3^+(0,0,1/3) 0,0,z$
($3_z 0,0,1/3$) | (3) $3^-(0,0,2/3) 0,0,z$
($3_z^{-1} 0,0,2/3$) |
| (4) $2 0,0,z$
($2_z 0,0,0$) | (5) $6^-(0,0,1/3) 0,0,z$
($6_z^{-1} 0,0,1/3$) | (6) $6^+(0,0,2/3) 0,0,z$
($6_z 0,0,2/3$) |
| (7) $2 x,x,1/6$
($2_{xy} 0,0,1/3$) | (8) $2 x,0,0$
($2_x 0,0,0$) | (9) $2 0,y,1/3$
($2_y 0,0,2/3$) |
| (10) $2 x,\bar{x},1/6$
($2_3 0,0,1/3$) | (11) $2 x,2x,0$
($2_2 0,0,0$) | (12) $2 2x,x,1/3$
($2_1 0,0,2/3$) |

For $1' + \text{set}$

- | | | |
|---|--|--|
| (1) $1'$
($1 0,0,0$)' | (2) $3^{+'}(0,0,1/3) 0,0,z$
($3_z 0,0,1/3$)' | (3) $3^{-'}(0,0,2/3) 0,0,z$
($3_z^{-1} 0,0,2/3$)' |
| (4) $2'$ $0,0,z$
($2_z 0,0,0$)' | (5) $6^{-'}(0,0,1/3) 0,0,z$
($6_z^{-1} 0,0,1/3$)' | (6) $6^{+'}(0,0,2/3) 0,0,z$
($6_z 0,0,2/3$)' |
| (7) $2'$ $x,x,1/6$
($2_{xy} 0,0,1/3$)' | (8) $2'$ $x,0,0$
($2_x 0,0,0$)' | (9) $2'$ $0,y,1/3$
($2_y 0,0,2/3$)' |
| (10) $2'$ $x,\bar{x},1/6$
($2_3 0,0,1/3$)' | (11) $2'$ $x,2x,0$
($2_2 0,0,0$)' | (12) $2'$ $2x,x,1/3$
($2_1 0,0,2/3$)' |

Generators selected (1); $t(0,0,1)$; (2); (4); (7); $1'$

Positions

Multiplicity, Wyckoff letter, Site symmetry	Coordinates		
		1+	1'+
12 h 11'	(1) x,y,z [0,0,0] (4) \bar{x},\bar{y},z [0,0,0] (7) $y,x,\bar{z}+1/3$ [0,0,0] (10) $\bar{y},\bar{x},\bar{z}+1/3$ [0,0,0]	(2) $\bar{y},x-y,z+1/3$ [0,0,0] (5) $y,\bar{x}+y,z+1/3$ [0,0,0] (8) $x-y,\bar{y},\bar{z}$ [0,0,0] (11) $\bar{x}+y,y,\bar{z}$ [0,0,0]	(3) $\bar{x}+y,\bar{x},z+2/3$ [0,0,0] (6) $x-y,x,z+2/3$ [0,0,0] (9) $\bar{x},\bar{x}+y,\bar{z}+2/3$ [0,0,0] (12) $x,x-y,\bar{z}+2/3$ [0,0,0]
6 g ..21'	$x,2x,1/2$ [0,0,0] $\bar{x},2\bar{x},1/2$ [0,0,0]	$2\bar{x},\bar{x},5/6$ [0,0,0] $2x,x,5/6$ [0,0,0]	$x,\bar{x},1/6$ [0,0,0] $\bar{x},x,1/6$ [0,0,0]
6 f ..21'	$x,2x,0$ [0,0,0] $\bar{x},2\bar{x},0$ [0,0,0]	$2\bar{x},\bar{x},1/3$ [0,0,0] $2x,x,1/3$ [0,0,0]	$x,\bar{x},2/3$ [0,0,0] $\bar{x},x,2/3$ [0,0,0]
6 e .2.1'	$x,0,1/2$ [0,0,0] $\bar{x},0,1/2$ [0,0,0]	$0,x,5/6$ [0,0,0] $0,\bar{x},5/6$ [0,0,0]	$\bar{x},\bar{x},1/6$ [0,0,0] $x,x,1/6$ [0,0,0]
6 d .2.1'	$x,0,0$ [0,0,0] $\bar{x},0,0$ [0,0,0]	$0,x,1/3$ [0,0,0] $0,\bar{x},1/3$ [0,0,0]	$\bar{x},\bar{x},2/3$ [0,0,0] $x,x,2/3$ [0,0,0]
6 c 2..1'	$0,0,z$ [0,0,0] $0,0,\bar{z}+1/3$ [0,0,0]	$0,0,z+1/3$ [0,0,0] $0,0,\bar{z}$ [0,0,0]	$0,0,z+2/3$ [0,0,0] $0,0,\bar{z}+2/3$ [0,0,0]
3 b 2221'	$0,0,1/2$ [0,0,0]	$0,0,5/6$ [0,0,0]	$0,0,1/6$ [0,0,0]
3 a 2221'	$0,0,0$ [0,0,0]	$0,0,1/3$ [0,0,0]	$0,0,2/3$ [0,0,0]

Symmetry of special projectionsAlong [001] $6mm1'$

Origin at 0,0,z

Along [100] $\rho 2mm1'$ $a^* = c$

Origin at x,0,0

Along [210] $\rho 2mm1'$ $a^* = c$

Origin at x,x/2,1/3

$p6_42'2'$

$62'2'$

Hexagonal

No. 66.3.333

$p6_42'2'$

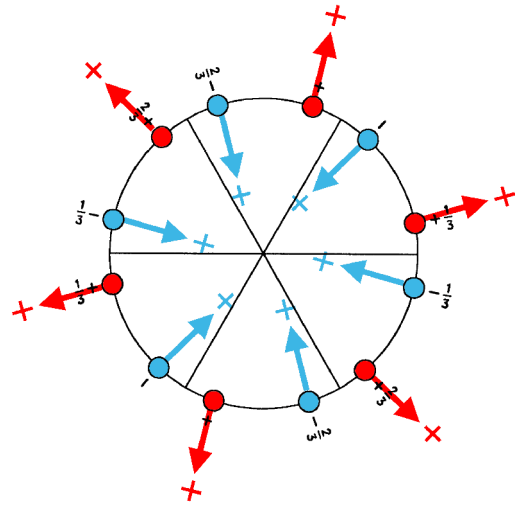
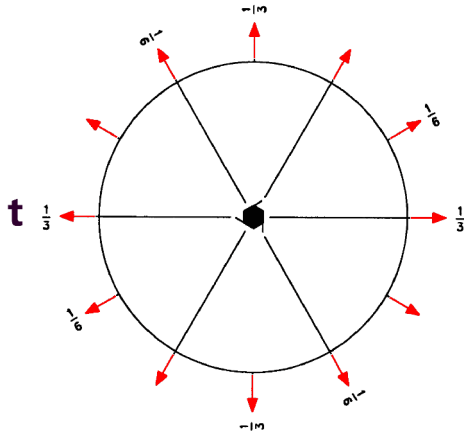

Origin on $2'2'2'$ at $6_4(2',1,1)(1,2',1)$

Asymmetric unit $0 \leq x: 0 \leq z \leq 1/6$

Symmetry operations

- | | | |
|---|---|---|
| (1) 1
(1 0,0,0) | (2) 3^+ (0,0,1/3) 0,0,z
(3_z 0,0,1/3) | (3) 3^- (0,0,2/3) 0,0,z
(3_z^{-1} 0,0,2/3) |
| (4) 2 0,0,z
(2_z 0,0,0) | (5) 6^- (0,0,1/3) 0,0,z
(6_z^{-1} 0,0,1/3) | (6) 6^+ (0,0,2/3) 0,0,z
(6_z 0,0,2/3) |
| (7) $2'$ x,x,1/6
(2_{xy} 0,0,1/3)' | (8) $2'$ x,0,0
(2_x 0,0,0)' | (9) $2'$ 0,y,1/3
(2_y 0,0,2/3)' |
| (10) $2'$ x, \bar{x} ,1/6
(2_3 0,0,1/3)' | (11) $2'$ x,2x,0
(2_2 0,0,0)' | (12) $2'$ 2x,x,1/3
(2_1 0,0,2/3)' |

Generators selected (1); $t(0,0,1)$; (2); (4); (7)

Positions

	Coordinates		
Multiplicity, Wyckoff letter, Site symmetry			
12 h 1	(1) x,y,z [u,v,w]	(2) $\bar{y},x-y,z+1/3$ [$\bar{v},u-v,w$]	(3) $\bar{x}+y,\bar{x},z+2/3$ [$\bar{u}+v,\bar{u},w$]
	(4) \bar{x},\bar{y},z [\bar{u},\bar{v},w]	(5) $y,\bar{x}+y,z+1/3$ [$v,\bar{u}+v,w$]	(6) $x-y,x,z+2/3$ [$u-v,u,w$]
	(7) $y,x,\bar{z}+1/3$ [\bar{v},\bar{u},w]	(8) $x-y,\bar{y},\bar{z}$ [$\bar{u}+v,v,w$]	(9) $\bar{x},\bar{x}+y,\bar{z}+2/3$ [$u,u-v,w$]
	(10) $\bar{y},\bar{x},\bar{z}+1/3$ [v,u,w]	(11) $\bar{x}+y,y,\bar{z}$ [$u-v,\bar{v},w$]	(12) $x,x-y,\bar{z}+2/3$ [$\bar{u},\bar{u}+v,w$]
6 g ..2'	$x,2x,1/2$ [u,0,w]	$2\bar{x},\bar{x},5/6$ [0,u,w]	$x,\bar{x},1/6$ [\bar{u},\bar{u},w]
	$\bar{x},2\bar{x},1/2$ [$\bar{u},0,w$]	$2x,x,5/6$ [0, \bar{u},w]	$\bar{x},x,1/6$ [u,u,w]
6 f ..2'	$x,2x,0$ [u,0,w]	$2\bar{x},\bar{x},1/3$ [0,u,w]	$x,\bar{x},2/3$ [\bar{u},\bar{u},w]
	$\bar{x},2\bar{x},0$ [$\bar{u},0,w$]	$2x,x,1/3$ [0, \bar{u},w]	$\bar{x},x,2/3$ [u,u,w]
6 e .2'	$x,0,1/2$ [u,2u,w]	$0,x,5/6$ [2 \bar{u},\bar{u},w]	$\bar{x},\bar{x},1/6$ [u, \bar{u},w]
	$\bar{x},0,1/2$ [$\bar{u},2\bar{u},w$]	$0,\bar{x},5/6$ [2u,u,w]	$x,x,1/6$ [\bar{u},u,w]
6 d .2'	$x,0,0$ [u,2u,w]	$0,x,1/3$ [2 \bar{u},\bar{u},w]	$\bar{x},\bar{x},2/3$ [u, \bar{u},w]
	$\bar{x},0,0$ [$\bar{u},2\bar{u},w$]	$0,\bar{x},1/3$ [2u,u,w]	$x,x,2/3$ [\bar{u},u,w]
6 c 2..	$0,0,z$ [0,0,w]	$0,0,z+1/3$ [0,0,w]	$0,0,z+2/3$ [0,0,w]
	$0,0,\bar{z}+1/3$ [0,0,w]	$0,0,\bar{z}$ [0,0,w]	$0,0,\bar{z}+2/3$ [0,0,w]
3 b 2'2'	$0,0,1/2$ [0,0,w]	$0,0,5/6$ [0,0,w]	$0,0,1/6$ [0,0,w]
3 a 2'2'	$0,0,0$ [0,0,w]	$0,0,1/3$ [0,0,w]	$0,0,2/3$ [0,0,w]

Continued

No. 66.3.333

$p6_4 2'2'$

Symmetry of special projections

Along [001] $6mm$

Origin at $0,0,z$

Along [100] $p2'mm'$

$a^* = c$

Origin at $x,0,0$

Along [210] $p2'mm'$

$a^* = c$

Origin at $x,x/2,1/3$

$p6_4'2'2'$

$6'2'2'$

Hexagonal

No. 66.4.334

$p6_4'2'2'$

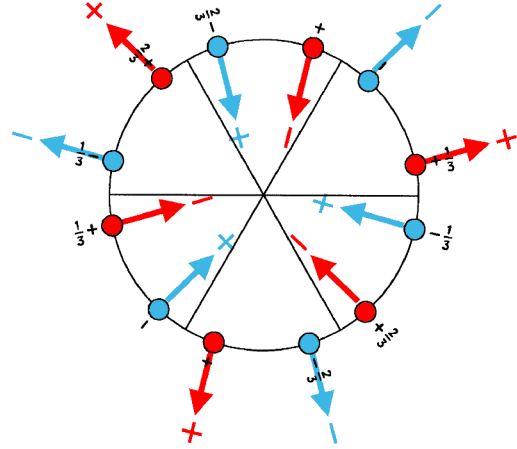
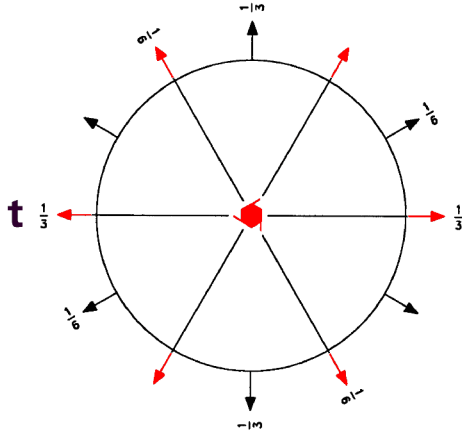

Origin on $2'2'2'$ at $6_4'(2',1,1)(1,2,1)$

Asymmetric unit $0 \leq x: 0 \leq z \leq 1/6$

Symmetry operations

- | | | |
|---|--|---|
| (1) 1
(1 0,0,0) | (2) 3^+ (0,0,1/3) 0,0,z
(3_z 0,0,1/3) | (3) 3^- (0,0,2/3) 0,0,z
(3_z^{-1} 0,0,2/3) |
| (4) $2'$ 0,0,z
(2_z 0,0,0)' | (5) 6^- (0,0,1/3) 0,0,z
(6_z^{-1} 0,0,1/3)' | (6) 6^+ (0,0,2/3) 0,0,z
(6_z 0,0,2/3)' |
| (7) $2'$ x,x,1/6
(2_{xy} 0,0,1/3)' | (8) $2'$ x,0,0
(2_x 0,0,0)' | (9) $2'$ 0,y,1/3
(2_y 0,0,2/3)' |
| (10) 2 x, \bar{x} ,1/6
(2_3 0,0,1/3) | (11) 2 x,2x,0
(2_2 0,0,0) | (12) 2 2x,x,1/3
(2_1 0,0,2/3) |

Generators selected (1); t(0,0,1); (2); (4); (7)

Positions

	Coordinates		
Multiplicity, Wyckoff letter, Site symmetry			
12 h 1	(1) x,y,z [u,v,w]	(2) $\bar{y},x-y,z+1/3$ [$\bar{v},u-v,w$]	(3) $\bar{x}+y,\bar{x},z+2/3$ [$\bar{u}+v,\bar{u},w$]
	(4) \bar{x},\bar{y},z [u,v, \bar{w}]	(5) $y,\bar{x}+y,z+1/3$ [$\bar{v},u-v,\bar{w}$]	(6) $x-y,x,z+2/3$ [$\bar{u}+v,\bar{u},\bar{w}$]
	(7) $y,x,\bar{z}+1/3$ [\bar{v},\bar{u},w]	(8) $x-y,\bar{y},\bar{z}$ [$\bar{u}+v,v,w$]	(9) $\bar{x},\bar{x}+y,\bar{z}+2/3$ [u,u-v,w]
	(10) $\bar{y},\bar{x},\bar{z}+1/3$ [\bar{v},\bar{u},\bar{w}]	(11) $\bar{x}+y,y,\bar{z}$ [$\bar{u}+v,v,\bar{w}$]	(12) $x,x-y,\bar{z}+2/3$ [u,u-v, \bar{w}]
6 g ..2	$x,2x,1/2$ [u,2u,0]	$2\bar{x},\bar{x},5/6$ [2 $\bar{u},\bar{u},0$]	$x,\bar{x},1/6$ [u, $\bar{u},0$]
	$\bar{x},2\bar{x},1/2$ [u,2u,0]	$2x,x,5/6$ [2 $\bar{u},\bar{u},0$]	$\bar{x},x,1/6$ [u, $\bar{u},0$]
6 f ..2	$x,2x,0$ [u,2u,0]	$2\bar{x},\bar{x},1/3$ [2 $\bar{u},\bar{u},0$]	$x,\bar{x},2/3$ [u, $\bar{u},0$]
	$\bar{x},2\bar{x},0$ [u,2u,0]	$2x,x,1/3$ [2 $\bar{u},\bar{u},0$]	$\bar{x},x,2/3$ [u, $\bar{u},0$]
6 e .2'	$x,0,1/2$ [u,2u,w]	$0,x,5/6$ [2 \bar{u},\bar{u},w]	$\bar{x},\bar{x},1/6$ [u, \bar{u},w]
	$\bar{x},0,1/2$ [u,2u, \bar{w}]	$0,\bar{x},5/6$ [2 \bar{u},\bar{u},\bar{w}]	$x,x,1/6$ [u, \bar{u},\bar{w}]
6 d .2'	$x,0,0$ [u,2u,w]	$0,x,1/3$ [2 \bar{u},\bar{u},w]	$\bar{x},\bar{x},2/3$ [u, \bar{u},w]
	$\bar{x},0,0$ [u,2u, \bar{w}]	$0,\bar{x},1/3$ [2 \bar{u},\bar{u},\bar{w}]	$x,x,2/3$ [u, \bar{u},\bar{w}]
6 c 2'..	$0,0,z$ [u,v,0]	$0,0,z+1/3$ [$\bar{v},u-v,0$]	$0,0,z+2/3$ [$\bar{u}+v,\bar{u},0$]
	$0,0,\bar{z}+1/3$ [$\bar{v},\bar{u},0$]	$0,0,\bar{z}$ [$\bar{u}+v,v,0$]	$0,0,\bar{z}+2/3$ [u,u-v,0]
3 b 2'2'2	$0,0,1/2$ [u,2u,0]	$0,0,5/6$ [2 $\bar{u},\bar{u},0$]	$0,0,1/6$ [u, $\bar{u},0$]
3 a 2'2'2	$0,0,0$ [u,2u,0]	$0,0,1/3$ [2 $\bar{u},\bar{u},0$]	$0,0,2/3$ [u, $\bar{u},0$]

Symmetry of special projections

Along [001] $6'mm'$

Origin at 0,0,z

Along [100] $p2'm'm$ $a^* = c$

Origin at x,0,0

Along [210] $p2mm$ $a^* = c$

Origin at x,x/2,1/3

$p_{2c}6_4'22'$

6221'

Hexagonal

No. 66.5.335

$p_{2c}6_4'22'$

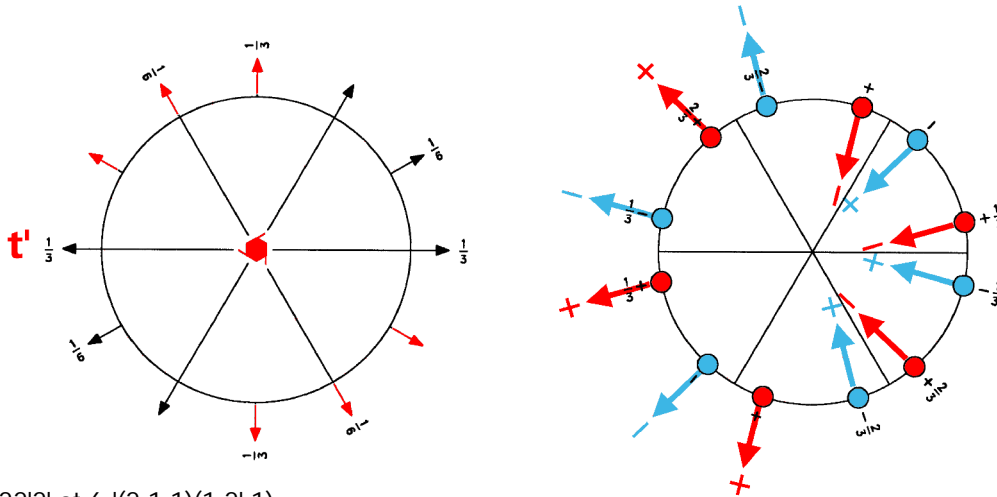

Origin on 22'2' at $6_4'(2,1,1)(1,2',1)$

Asymmetric unit $0 \leq x: 0 \leq z \leq 1/6$

Symmetry operations

For (0,0,0) + set

- | | | |
|---|---|---|
| (1) 1
(1 0,0,0) | (2) 3^+ (0,0,1/3) 0,0,z
(3_z 0,0,1/3)' | (3) 3^- (0,0,2/3) 0,0,z
(3_z^{-1} 0,0,2/3) |
| (4) $2'$ 0,0,z
(2_z 0,0,0)' | (5) 6^- (0,0,1/3) 0,0,z
(6_z^{-1} 0,0,1/3) | (6) 6^+ (0,0,2/3) 0,0,z
(6_z 0,0,2/3)' |
| (7) $2'$ x,x,1/6
(2_{xy} 0,0,1/3)' | (8) 2 x,0,0
(2_x 0,0,0) | (9) 2 0,y,1/3
(2_y 0,0,2/3) |
| (10) 2 x, \bar{x} ,1/6
(2_3 0,0,1/3) | (11) $2'$ x,2x,0
(2_2 0,0,0)' | (12) $2'$ 2x,x,1/3
(2_1 0,0,2/3)' |

For (0,01)' + set

- | | | |
|---|--|--|
| (1) t' (0,0,1)
(1 0,0,1)' | (2) 3^+ (0,0,4/3) 0,0,z
(3_z 0,0,4/3) | (3) 3^- (0,0,5/3) 0,0,z
(3_z^{-1} 0,0,5/3)' |
| (4) 2 (0,0,1) 0,0,z
(2_z 0,0,1) | (5) 6^- (0,0,4/3) 0,0,z
(6_z^{-1} 0,0,4/3)' | (6) 6^+ (0,0,5/3) 0,0,z
(6_z 0,0,5/3) |
| (7) 2 x,x,2/3
(2_{xy} 0,0,4/3) | (8) $2'$ x,0,1/2
(2_x 0,0,1)' | (9) $2'$ 0,y,5/6
(2_y 0,0,5/3)' |
| (10) $2'$ x, \bar{x} ,2/3
(2_3 0,0,4/3)' | (11) 2 x,2x,1/2
(2_2 0,0,1) | (12) 2 2x,x,5/6
(2_1 0,0,5/3) |

Generators selected (1); $t(0,0,1)'$; (2); (4); (7)

Positions

Multiplicity, Wyckoff letter, Site symmetry	Coordinates		
		(0,0,0)+	(0,0,1)' +
12 h 1	(1) $x,y,z [u,v,w]$	(2) $\bar{y},x-y,z+1/3 [v,\bar{u}+v,\bar{w}]$	(3) $\bar{x}+y,\bar{x},z+2/3 [\bar{u}+v,\bar{u},w]$
	(4) $\bar{x},\bar{y},z [u,v,\bar{w}]$	(5) $y,\bar{x}+y,z+1/3 [v,\bar{u}+v,w]$	(6) $x-y,x,z+2/3 [\bar{u}+v,\bar{u},\bar{w}]$
	(7) $y,x,\bar{z}+1/3 [\bar{v},\bar{u},w]$	(8) $x-y,\bar{y},\bar{z} [u-v,\bar{v},\bar{w}]$	(9) $\bar{x},\bar{x}+y,\bar{z}+2/3 [\bar{u},\bar{u}+v,\bar{w}]$
	(10) $\bar{y},\bar{x},\bar{z}+1/3 [\bar{v},\bar{u},\bar{w}]$	(11) $\bar{x}+y,y,\bar{z} [u-v,\bar{v},w]$	(12) $x,x-y,\bar{z}+2/3 [\bar{u},\bar{u}+v,w]$
6 g ..2	$x,2x,1/2 [u,2u,0]$	$2\bar{x},\bar{x},5/6 [2u,u,0]$	$x,\bar{x},1/6 [\bar{u},u,0]$
	$\bar{x},2\bar{x},1/2 [u,2u,0]$	$2x,x,5/6 [2u,u,0]$	$\bar{x},x,1/6 [\bar{u},u,0]$
6 f ..2'	$x,2x,0 [u,0,w]$	$2\bar{x},\bar{x},1/3 [0,\bar{u},\bar{w}]$	$x,\bar{x},2/3 [\bar{u},\bar{u},w]$
	$\bar{x},2\bar{x},0 [u,0,\bar{w}]$	$2x,x,1/3 [0,\bar{u},\bar{w}]$	$\bar{x},x,2/3 [\bar{u},\bar{u},\bar{w}]$
6 e .2'	$x,0,1/2 [u,2u,w]$	$0,x,5/6 [2u,u,w]$	$\bar{x},\bar{x},1/6 [\bar{u},u,\bar{w}]$
	$\bar{x},0,1/2 [u,2u,\bar{w}]$	$0,\bar{x},5/6 [2u,u,\bar{w}]$	$x,x,1/6 [\bar{u},u,w]$
6 d .2.	$x,0,0 [u,0,0]$	$0,x,1/3 [0,\bar{u},0]$	$\bar{x},\bar{x},2/3 [\bar{u},\bar{u},0]$
	$\bar{x},0,0 [u,0,0]$	$0,\bar{x},1/3 [0,\bar{u},0]$	$x,x,2/3 [\bar{u},\bar{u},0]$
6 c 2'..	$0,0,z [u,v,0]$	$0,0,z+1/3 [v,\bar{u}+v,0]$	$0,0,z+2/3 [\bar{u}+v,\bar{u},0]$
	$0,0,\bar{z}+1/3 [\bar{v},\bar{u},0]$	$0,0,\bar{z} [u-v,\bar{v},0]$	$0,0,\bar{z}+2/3 [\bar{u},\bar{u}+v,0]$
3 b 2'2'2	$0,0,1/2 [u,2u,0]$	$0,0,5/6 [2u,u,0]$	$0,0,1/6 [\bar{u},u,0]$
3 a 2'22'	$0,0,0 [u,0,0]$	$0,0,1/3 [0,\bar{u},0]$	$0,0,2/3 [\bar{u},\bar{u},0]$

Continued

No. 66.5.335

$p_{2c} 6_4 '22'$

Symmetry of special projections

Along [001] $6mm1'$

Origin at 0,0,z

Along [100] $p_{2a^*} 2m'm'$

$a^* = c$

Origin at x,0,0

Along [210] $p_{2a^*} 2m'm'$

$a^* = c$

Origin at x,x/2,1/3

$p_{2c}6_422$

6221'

Hexagonal

No. 66.6.336

$p_{2c}6_422$

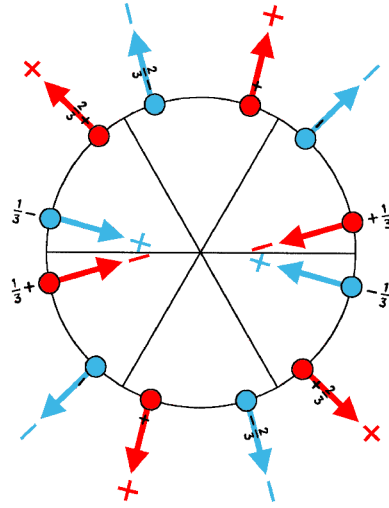
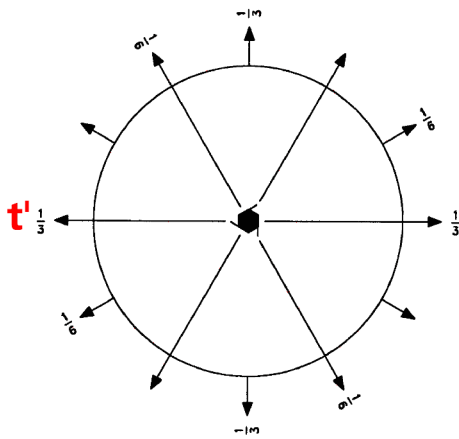

Origin on 222 at $6_4(2,1,1)(1,2,1)$

Asymmetric unit $0 \leq x: 0 \leq z \leq 1/6$

Symmetry operations

For (0,0,0) + set

- | | | |
|---|--|---|
| (1) 1
(1 0,0,0) | (2) $3^+ (0,0,1/3) \ 0,0,z$
(3_z 0,0,1/3)' | (3) $3^- (0,0,2/3) \ 0,0,z$
(3_z^{-1} 0,0,2/3) |
| (4) 2 $0,0,z$
(2_z 0,0,0) | (5) $6^- (0,0,1/3) \ 0,0,z$
(6_z^{-1} 0,0,1/3)' | (6) $6^+ (0,0,2/3) \ 0,0,z$
(6_z 0,0,2/3) |
| (7) $2' \ x,x,1/6$
(2_{xy} 0,0,1/3)' | (8) 2 $x,0,0$
(2_x 0,0,0) | (9) 2 $0,y,1/3$
(2_y 0,0,2/3) |
| (10) $2' \ x,\bar{x},1/6$
(2_3 0,0,1/3)' | (11) 2 $x,2x,0$
(2_2 0,0,0) | (12) 2 $2x,x,1/3$
(2_1 0,0,2/3) |

For (0,01)' + set

- | | | |
|--|---|--|
| (1) $t' (0,0,1)$
(1 0,0,1)' | (2) $3^+ (0,0,4/3) \ 0,0,z$
(3_z 0,0,4/3) | (3) $3^- (0,0,5/3) \ 0,0,z$
(3_z^{-1} 0,0,5/3)' |
| (4) $2' (0,0,1) \ 0,0,z$
(2_z 0,0,1)' | (5) $6^- (0,0,4/3) \ 0,0,z$
(6_z^{-1} 0,0,4/3) | (6) $6^+ (0,0,5/3) \ 0,0,z$
(6_z 0,0,5/3)' |
| (7) 2 $x,x,2/3$
(2_{xy} 0,0,4/3) | (8) $2' \ x,0,1/2$
(2_x 0,0,1)' | (9) $2' \ 0,y,5/6$
(2_y 0,0,5/3)' |
| (10) 2 $x,\bar{x},2/3$
(2_3 0,0,4/3) | (11) $2' \ x,2x,1/2$
(2_2 0,0,1)' | (12) $2' \ 2x,x,5/6$
(2_1 0,0,5/3)' |

Generators selected (1); $t(0,0,1)'$; (2); (4); (7)

Positions

Multiplicity, Wyckoff letter, Site symmetry	Coordinates		
		(0,0,0)+	(0,0,1)' +
12 h 1	(1) x,y,z [u,v,w]	(2) $\bar{y},x-y,z+1/3$ [v, $\bar{u}+v,\bar{w}$]	(3) $\bar{x}+y,\bar{x},z+2/3$ [$\bar{u}+v,\bar{u},w$]
	(4) \bar{x},\bar{y},z [\bar{u},\bar{v},w]	(5) $y,\bar{x}+y,z+1/3$ [$\bar{v},u-v,\bar{w}$]	(6) $x-y,x,z+2/3$ [u-v,u,w]
	(7) $y,x,\bar{z}+1/3$ [\bar{v},\bar{u},w]	(8) $x-y,\bar{y},\bar{z}$ [u-v, \bar{v},\bar{w}]	(9) $\bar{x},\bar{x}+y,\bar{z}+2/3$ [$\bar{u},\bar{u}+v,\bar{w}$]
	(10) $\bar{y},\bar{x},\bar{z}+1/3$ [v,u,w]	(11) $\bar{x}+y,y,\bar{z}$ [$\bar{u}+v,v,\bar{w}$]	(12) $x,x-y,\bar{z}+2/3$ [u,u-v, \bar{w}]
6 g ..2'	$x,2x,1/2$ [u,0,w]	$2\bar{x},\bar{x},5/6$ [0, \bar{u},\bar{w}]	$x,\bar{x},1/6$ [u,u, \bar{w}]
	$\bar{x},2\bar{x},1/2$ [$\bar{u},0,w$]	$2x,x,5/6$ [0,u, \bar{w}]	$\bar{x},x,1/6$ [\bar{u},\bar{u},\bar{w}]
6 f ..2	$x,2x,0$ [u,2u,0]	$2\bar{x},\bar{x},1/3$ [2u,u,0]	$x,\bar{x},2/3$ [u, $\bar{u},0$]
	$\bar{x},2\bar{x},0$ [$\bar{u},2\bar{u},0$]	$2x,x,1/3$ [2 $\bar{u},\bar{u},0$]	$\bar{x},x,2/3$ [$\bar{u},u,0$]
6 e .2'	$x,0,1/2$ [u,2u,w]	$0,x,5/6$ [2u,u, \bar{w}]	$\bar{x},\bar{x},1/6$ [\bar{u},u,\bar{w}]
	$\bar{x},0,1/2$ [$\bar{u},2\bar{u},w$]	$0,\bar{x},5/6$ [2 \bar{u},\bar{u},w]	$x,x,1/6$ [u, \bar{u},\bar{w}]
6 d .2.	$x,0,0$ [u,0,0]	$0,x,1/3$ [0, $\bar{u},0$]	$\bar{x},\bar{x},2/3$ [$\bar{u},\bar{u},0$]
	$\bar{x},0,0$ [$\bar{u},0,0$]	$0,\bar{x},1/3$ [0,u,0]	$x,x,2/3$ [u,u,0]
6 c 2..	$0,0,z$ [0,0,w]	$0,0,z+1/3$ [0,0, \bar{w}]	$0,0,z+2/3$ [0,0,w]
	$0,0,\bar{z}+1/3$ [0,0,w]	$0,0,\bar{z}$ [0,0, \bar{w}]	$0,0,\bar{z}+2/3$ [0,0, \bar{w}]
3 b 22'2'	$0,0,1/2$ [0,0,w]	$0,0,5/6$ [0,0, \bar{w}]	$0,0,1/6$ [0,0, \bar{w}]
3 a 222	$0,0,0$ [0,0,0]	$0,0,1/3$ [0,0,0]	$0,0,2/3$ [0,0,0]

Symmetry of special projections

Along [001] $6mm1'$

Origin at 0,0,z

Along [100] $p_{2a^*} 2m'm'$ $a^* = c$

Origin at x,0,0

Along [210] $p_{2a^*} 2m'm'$ $a^* = c$

Origin at x,x/2,1/3

$p6_522$

622

Hexagonal

No. 67.1.337

$p6_522$

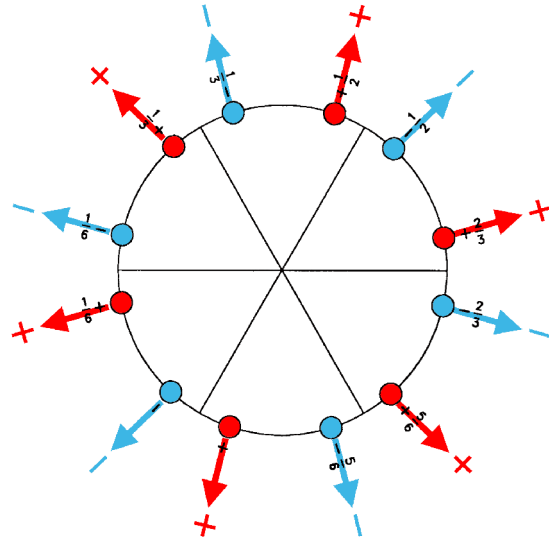
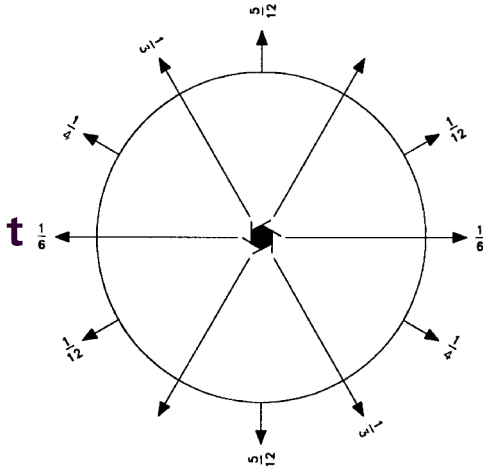

Origin on $2[100]$ at $6_5(2,1,1)$

Asymmetric unit $0 \leq z \leq 1/12$

Symmetry operations

- | | | |
|--|---|---|
| (1) 1
(1 0,0,0) | (2) 3^+ (0,0,2/3) 0,0,z
(3_z 0,0,2/3) | (3) 3^- (0,0,1/3) 0,0,z
(3_z^{-1} 0,0,1/3) |
| (4) 2 (0,0,1/2) 0,0,z
(2_z 0,0,1/2) | (5) 6^- (0,0,1/6) 0,0,z
(6_z^{-1} 0,0,1/6) | (6) 6^+ (0,0,5/6) 0,0,z
(6_z 0,0,5/6) |
| (7) 2 x,x,1/3
(2_{xy} 0,0,2/3) | (8) 2 x,0,0
(2_x 0,0,0) | (9) 2 0,y,1/6
(2_y 0,0,1/3) |
| (10) 2 x, \bar{x} ,1/12
(2_3 0,0,1/6) | (11) 2 x,2x,1/4
(2_2 0,0,1/2) | (12) 2 2x,x,5/12
(2_1 0,0,5/6) |

Generators selected (1); t(0,0,1); (2); (4); (7)

Positions

	Coordinates		
Multiplicity, Wyckoff letter, Site symmetry			
12 c 1	(1) x, y, z [u,v,w]	(2) $\bar{y}, x-y, z+2/3$ [$\bar{v}, u-v, w$]	(3) $\bar{x}+y, \bar{x}, z+1/3$ [$\bar{u}+v, \bar{u}, w$]
	(4) $\bar{x}, \bar{y}, z+1/2$ [\bar{u}, \bar{v}, w]	(5) $y, \bar{x}+y, z+1/6$ [$v, \bar{u}+v, w$]	(6) $x-y, x, z+5/6$ [$u-v, u, w$]
	(7) $y, x, \bar{z}+2/3$ [v, u, \bar{w}]	(8) $x-y, \bar{y}, \bar{z}$ [$u-v, \bar{v}, \bar{w}$]	(9) $\bar{x}, \bar{x}+y, \bar{z}+1/3$ [$\bar{u}, \bar{u}+v, \bar{w}$]
	(10) $\bar{y}, \bar{x}, \bar{z}+1/6$ [$\bar{v}, \bar{u}, \bar{w}$]	(11) $\bar{x}+y, y, \bar{z}+1/2$ [$\bar{u}+v, v, \bar{w}$]	(12) $x, x-y, \bar{z}+5/6$ [$u, u-v, \bar{w}$]
6 b ..2	$x, 2x, 3/4$ [u,2u,0]	$2\bar{x}, \bar{x}, 5/12$ [$2\bar{u}, \bar{u}, 0$]	$x, \bar{x}, 1/12$ [u, \bar{u} ,0]
	$\bar{x}, 2\bar{x}, 1/4$ [$\bar{u}, 2\bar{u}, 0$]	$2x, x, 11/12$ [$2u, u, 0$]	$\bar{x}, x, 7/12$ [$\bar{u}, u, 0$]
6 a .2.	$x, 0, 0$ [u,0,0]	$0, x, 2/3$ [0,u,0]	$\bar{x}, \bar{x}, 1/3$ [$\bar{u}, \bar{u}, 0$]
	$\bar{x}, 0, 1/2$ [$\bar{u}, 0, 0$]	$0, \bar{x}, 1/6$ [0, \bar{u} ,0]	$x, x, 5/6$ [u,u,0]

Symmetry of special projections

Along [001] 6m'm'	Along [100] p2m'g'	Along [210] p2m'g'
Origin at 0,0,z	$a^* = c$ Origin at x,0,0	$a^* = c$ Origin at x,x/2,5/12

$p6_5221'$

$6221'$

Hexagonal

No. 67.2.338

$p6_5221'$

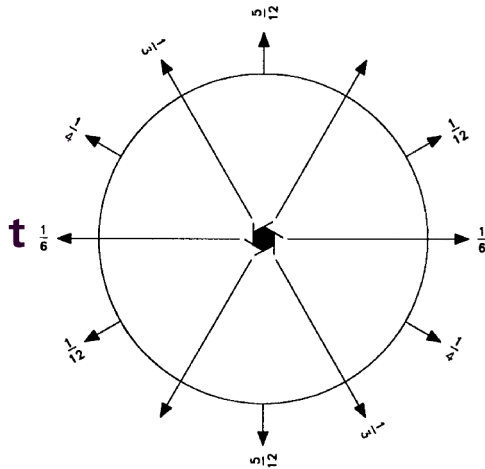

$1'$

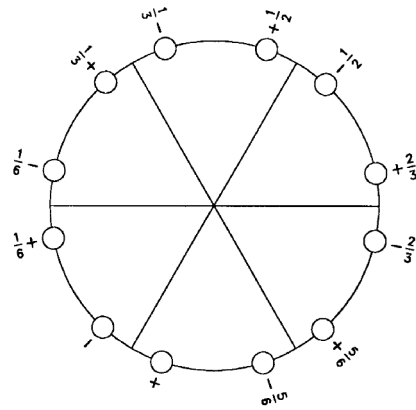

Origin on $2[100]1'$ at $6_5(2,1,1)11'$

Asymmetric unit $0 \leq z \leq 1/12$

Symmetry operations

For $1 +$ set

- | | | |
|--|--|--|
| (1) 1
($1 0,0,0$) | (2) $3^+(0,0,2/3) 0,0,z$
($3_z 0,0,2/3$) | (3) $3^-(0,0,1/3) 0,0,z$
($3_z^{-1} 0,0,1/3$) |
| (4) $2(0,0,1/2) 0,0,z$
($2_z 0,0,1/2$) | (5) $6^-(0,0,1/6) 0,0,z$
($6_z^{-1} 0,0,1/6$) | (6) $6^+(0,0,5/6) 0,0,z$
($6_z 0,0,5/6$) |
| (7) $2 x,x,1/3$
($2_{xy} 0,0,2/3$) | (8) $2 x,0,0$
($2_x 0,0,0$) | (9) $2 0,y,1/6$
($2_y 0,0,1/3$) |
| (10) $2 x,\bar{x},1/12$
($2_3 0,0,1/6$) | (11) $2 x,2x,1/4$
($2_2 0,0,1/2$) | (12) $2 2x,x,5/12$
($2_1 0,0,5/6$) |

For $1' +$ set

- | | | |
|--|--|--|
| (1) $1'$
($1 0,0,0$)' | (2) $3^{+'}(0,0,2/3) 0,0,z$
($3_z 0,0,2/3$)' | (3) $3^{-'}(0,0,1/3) 0,0,z$
($3_z^{-1} 0,0,1/3$)' |
| (4) $2'(0,0,1/2) 0,0,z$
($2_z 0,0,1/2$)' | (5) $6^{-'}(0,0,1/6) 0,0,z$
($6_z^{-1} 0,0,1/6$)' | (6) $6^{+'}(0,0,5/6) 0,0,z$
($6_z 0,0,5/6$)' |
| (7) $2' x,x,1/3$
($2_{xy} 0,0,2/3$)' | (8) $2' x,0,0$
($2_x 0,0,0$)' | (9) $2' 0,y,1/6$
($2_y 0,0,1/3$)' |
| (10) $2' x,\bar{x},1/12$
($2_3 0,0,1/6$)' | (11) $2' x,2x,1/4$
($2_2 0,0,1/2$)' | (12) $2' 2x,x,5/12$
($2_1 0,0,5/6$)' |

Generators selected (1); $t(0,0,1)$; (2); (4); (7); $1'$

Positions

Multiplicity, Wyckoff letter, Site symmetry	Coordinates		
		1+	1'+
12 c 11'	(1) x,y,z [0,0,0] (4) $\bar{x},\bar{y},z+1/2$ [0,0,0] (7) $y,x,\bar{z}+2/3$ [0,0,0] (10) $\bar{y},\bar{x},\bar{z}+1/6$ [0,0,0]	(2) $\bar{y},x-y,z+2/3$ [0,0,0] (5) $y,\bar{x}+y,z+1/6$ [0,0,0] (8) $x-y,\bar{y},\bar{z}$ [0,0,0] (11) $\bar{x}+y,y,\bar{z}+1/2$ [0,0,0]	(3) $\bar{x}+y,\bar{x},z+1/3$ [0,0,0] (6) $x-y,x,z+5/6$ [0,0,0] (9) $\bar{x},\bar{x}+y,\bar{z}+1/3$ [0,0,0] (12) $x,x-y,\bar{z}+5/6$ [0,0,0]
6 b ..21'	$x,2x,3/4$ [0,0,0] $\bar{x},2\bar{x},1/4$ [0,0,0]	$2\bar{x},\bar{x},5/12$ [0,0,0] $2x,x,11/12$ [0,0,0]	$x,\bar{x},1/12$ [0,0,0] $\bar{x},x,7/12$ [0,0,0]
6 a .2.1'	$x,0,0$ [0,0,0] $\bar{x},0,1/2$ [0,0,0]	$0,x,2/3$ [0,0,0] $0,\bar{x},1/6$ [0,0,0]	$\bar{x},\bar{x},1/3$ [0,0,0] $x,x,5/6$ [0,0,0]

Symmetry of special projections

Along [001] $6mm1'$	Along [100] $\rho 2mg1'$	Along [210] $\rho 2mg1'$
Origin at 0,0,z	$a^* = c$ Origin at $x,0,0$	$a^* = c$ Origin at $x,x/2,5/12$

$p6_5 2' 2'$

$62' 2'$

Hexagonal

No. 67.3.339

$p6_5 2' 2'$

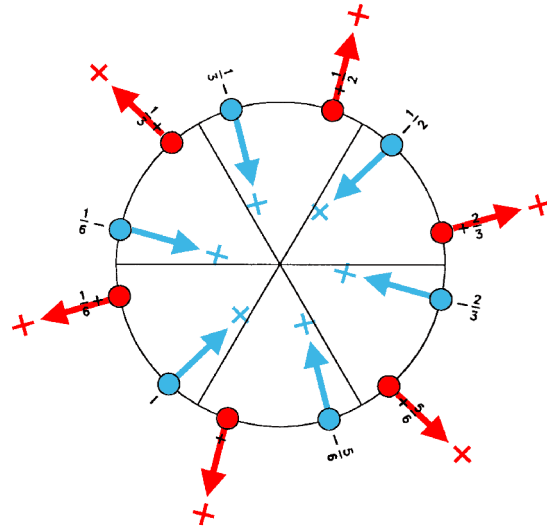
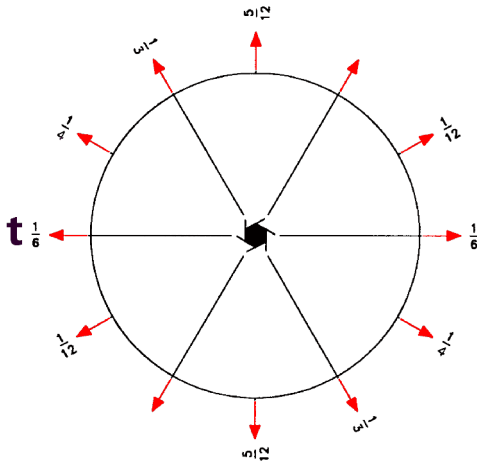

Origin on $2'[100]$ at $6_5(2', 1, 1)1$

Asymmetric unit $0 \leq z \leq 1/12$

Symmetry operations

- | | | |
|--|---|---|
| (1) 1
(1 0,0,0) | (2) $3^+ (0,0,2/3) \ 0,0,z$
(3_z 0,0,2/3) | (3) $3^- (0,0,1/3) \ 0,0,z$
(3_z^{-1} 0,0,1/3) |
| (4) $2 (0,0,1/2) \ 0,0,z$
(2_z 0,0,1/2) | (5) $6^- (0,0,1/6) \ 0,0,z$
(6_z^{-1} 0,0,1/6) | (6) $6^+ (0,0,5/6) \ 0,0,z$
(6_z 0,0,5/6) |
| (7) $2' \ x,x,1/3$
(2_{xy} 0,0,2/3)' | (8) $2' \ x,0,0$
(2_x 0,0,0)' | (9) $2' \ 0,y,1/6$
(2_y 0,0,1/3)' |
| (10) $2' \ x,\bar{x},1/12$
(2_3 0,0,1/6)' | (11) $2' \ x,2x,1/4$
(2_2 0,0,1/2)' | (12) $2' \ 2x,x,5/12$
(2_1 0,0,5/6)' |

Generators selected (1); $t(0,0,1)$; (2); (4); (7)

Positions

	Coordinates		
Multiplicity, Wyckoff letter, Site symmetry			
12 c 1	(1) x,y,z [u,v,w]	(2) $\bar{y},x-y,z+2/3$ [$\bar{v},u-v,w$]	(3) $\bar{x}+y,\bar{x},z+1/3$ [$\bar{u}+v,\bar{u},w$]
	(4) $\bar{x},\bar{y},z+1/2$ [\bar{u},\bar{v},w]	(5) $y,\bar{x}+y,z+1/6$ [$v,\bar{u}+v,w$]	(6) $x-y,x,z+5/6$ [$u-v,u,w$]
	(7) $y,x,\bar{z}+2/3$ [\bar{v},\bar{u},w]	(8) $x-y,\bar{y},\bar{z}$ [$\bar{u}+v,v,w$]	(9) $\bar{x},\bar{x}+y,\bar{z}+1/3$ [$u,u-v,w$]
	(10) $\bar{y},\bar{x},\bar{z}+1/6$ [v,u,w]	(11) $\bar{x}+y,y,\bar{z}+1/2$ [$u-v,\bar{v},w$]	(12) $x,x-y,\bar{z}+5/6$ [$\bar{u},\bar{u}+v,w$]
6 b ..2'	$x,2x,3/4$ [u,0,w]	$2\bar{x},\bar{x},5/12$ [0,u,w]	$x,\bar{x},1/12$ [\bar{u},\bar{u},w]
	$\bar{x},2\bar{x},1/4$ [$\bar{u},0,w$]	$2x,x,11/12$ [0, \bar{u},w]	$\bar{x},x,7/12$ [u,u,w]
6 a .2'	$x,0,0$ [u,2u,w]	$0,x,2/3$ [2 \bar{u},\bar{u},w]	$\bar{x},\bar{x},1/3$ [u, \bar{u},w]
	$\bar{x},0,1/2$ [$\bar{u},2\bar{u},w$]	$0,\bar{x},1/6$ [2u,u,w]	$x,x,5/6$ [\bar{u},u,w]

Symmetry of special projections

Along [001] 6mm	Along [100] $\rho 2'mg'$ $a^* = c$	Along [210] $\rho 2'mg'$ $a^* = c$
Origin at 0,0,z	Origin at x,0,0	Origin at x,x/2,5/12

$p6_5'2'2'$

$6'2'2'$

Hexagonal

No. 67.4.340

$p6_5'2'2'$

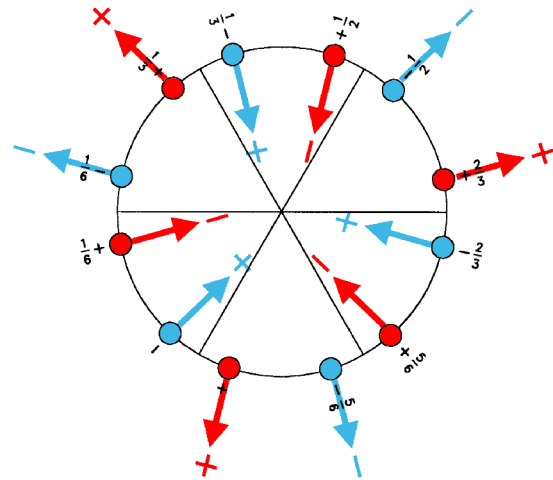
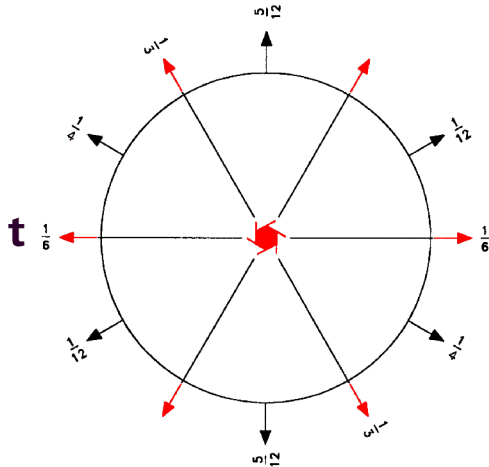

Origin on $2'[100]$ at $6_5'(2',1,1)1$

Asymmetric unit $0 \leq z \leq 1/12$

Symmetry operations

- | | | |
|--|--|---|
| (1) 1
(1 0,0,0) | (2) 3^+ (0,0,2/3) 0,0,z
(3_z 0,0,2/3) | (3) 3^- (0,0,1/3) 0,0,z
(3_z^{-1} 0,0,1/3) |
| (4) $2'$ (0,0,1/2) 0,0,z
(2_z 0,0,1/2)' | (5) 6^- (0,0,1/6) 0,0,z
(6_z^{-1} 0,0,1/6)' | (6) 6^+ (0,0,5/6) 0,0,z
(6_z 0,0,5/6)' |
| (7) $2'$ x,x,1/3
(2_{xy} 0,0,2/3)' | (8) $2'$ x,0,0
(2_x 0,0,0)' | (9) $2'$ 0,y,1/6
(2_y 0,0,1/3)' |
| (10) 2 x, \bar{x} ,1/12
(2_3 0,0,1/6) | (11) 2 x,2x,1/4
(2_2 0,0,1/2) | (12) 2 2x,x,5/12
(2_1 0,0,5/6) |

Generators selected (1); $t(0,0,1)$; (2); (4); (7)

Positions

	Coordinates		
Multiplicity, Wyckoff letter, Site symmetry			
12 c 1	(1) x,y,z [u,v,w]	(2) $\bar{y},x-y,z+2/3$ [$\bar{v},u-v,w$]	(3) $\bar{x}+y,\bar{x},z+1/3$ [$\bar{u}+v,\bar{u},w$]
	(4) $\bar{x},\bar{y},z+1/2$ [u,v, \bar{w}]	(5) $y,\bar{x}+y,z+1/6$ [$\bar{v},u-v,\bar{w}$]	(6) $x-y,x,z+5/6$ [$\bar{u}+v,\bar{u},\bar{w}$]
	(7) $y,x,\bar{z}+2/3$ [\bar{v},\bar{u},w]	(8) $x-y,\bar{y},\bar{z}$ [$\bar{u}+v,v,w$]	(9) $\bar{x},\bar{x}+y,\bar{z}+1/3$ [u,u-v,w]
	(10) $\bar{y},\bar{x},\bar{z}+1/6$ [\bar{v},\bar{u},\bar{w}]	(11) $\bar{x}+y,y,\bar{z}+1/2$ [$\bar{u}+v,v,\bar{w}$]	(12) $x,x-y,\bar{z}+5/6$ [u,u-v, \bar{w}]
6 b ..2	$x,2x,3/4$ [u,2u,0]	$2\bar{x},\bar{x},5/12$ [$2\bar{u},\bar{u},0$]	$x,\bar{x},1/12$ [u, $\bar{u},0$]
	$\bar{x},2\bar{x},1/4$ [u,2u,0]	$2x,x,11/12$ [$2\bar{u},\bar{u},0$]	$\bar{x},x,7/12$ [u, $\bar{u},0$]
6 a .2'	$x,0,0$ [u,2u,w]	$0,x,2/3$ [$2\bar{u},\bar{u},w$]	$\bar{x},\bar{x},1/3$ [u, \bar{u},w]
	$\bar{x},0,1/2$ [u,2u, \bar{w}]	$0,\bar{x},1/6$ [$2\bar{u},\bar{u},\bar{w}$]	$x,x,5/6$ [u, \bar{u},\bar{w}]

Symmetry of special projections

Along [001] $6'mm'$	Along [100] $\rho 2'm'g$	Along [210] $\rho 2mg$
Origin at 0,0,z	$a^* = c$ Origin at x,0,0	$a^* = c$ Origin at x,x/2,5/12

$\rho 6mm$

6mm

Hexagonal

No. 68.1.341

$\rho 6mm$

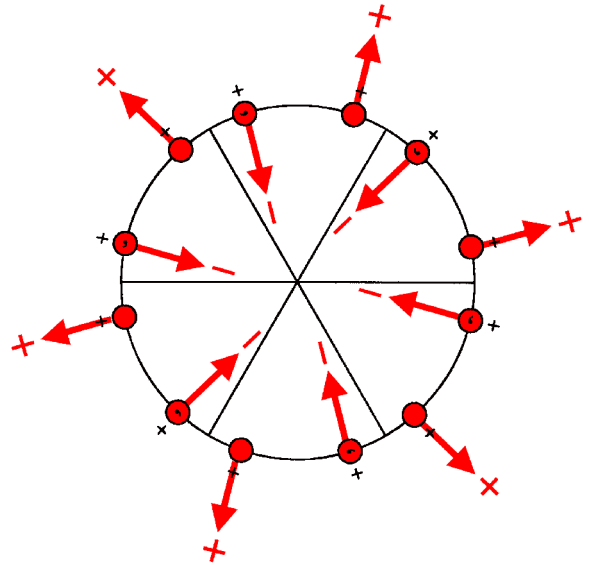
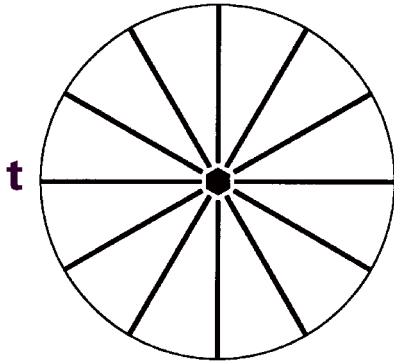

Origin on 6mm

Asymmetric unit $0 \leq x; 0 \leq y; 0 \leq z \leq 1; y \leq x/2$

Symmetry operations

- | | | |
|---|---|---|
| (1) 1
(1 0,0,0) | (2) 3^+ 0,0,z
(3_z 0,0,0) | (3) 3^- 0,0,z
(3_z^{-1} 0,0,0) |
| (4) 2 0,0,z
(2_z 0,0,0) | (5) 6^- 0,0,z
(6_z^{-1} 0,0,0) | (6) 6^+ 0,0,z
(6_z 0,0,0) |
| (7) m x, \bar{x}, z
(m_{xy} 0,0,0) | (8) m $x, 2x, z$
(m_x 0,0,0) | (9) m $2x, x, z$
(m_y 0,0,0) |
| (10) m x, x, z
(m_3 0,0,0) | (11) m $x, 0, z$
(m_2 0,0,0) | (12) m $0, y, z$
(m_1 0,0,0) |

Generators selected (1); $t(0,0,1)$; (2); (4); (7)

Positions

Multiplicity, Wyckoff letter, Site symmetry	Coordinates		
	(1) x,y,z [u,v,w]	(2) $\bar{y},x-y,z$ [$\bar{v},u-v,w$]	(3) $\bar{x}+y,\bar{x},z$ [$\bar{u}+v,\bar{u},w$]
12 d 1	(4) \bar{x},\bar{y},z [\bar{u},\bar{v},w]	(5) $y,\bar{x}+y,z$ [$v,\bar{u}+v,w$]	(6) $x-y,x,z$ [$u-v,u,w$]
	(7) \bar{y},\bar{x},z [v,u,\bar{w}]	(8) $\bar{x}+y,y,z$ [$u-v,\bar{v},\bar{w}$]	(9) $x,x-y,z$ [$\bar{u},\bar{u}+v,\bar{w}$]
	(10) y,x,z [\bar{v},\bar{u},\bar{w}]	(11) $x-y,\bar{y},z$ [$\bar{u}+v,v,\bar{w}$]	(12) $\bar{x},\bar{x}+y,z$ [$u,u-v,\bar{w}$]
6 c .m.	x,\bar{x},z [$u,u,0$]	$x,2x,z$ [$\bar{u},0,0$]	$2\bar{x},\bar{x},z$ [$0,\bar{u},0$]
	\bar{x},x,z [$\bar{u},\bar{u},0$]	$\bar{x},2\bar{x},z$ [$u,0,0$]	$2x,x,z$ [$0,u,0$]
6 b ..m	$x,0,z$ [$u,2u,0$]	$0,x,z$ [$2\bar{u},\bar{u},0$]	\bar{x},\bar{x},z [$u,\bar{u},0$]
	$\bar{x},0,z$ [$\bar{u},2\bar{u},0$]	$0,\bar{x},z$ [$2u,u,0$]	x,x,z [$\bar{u},u,0$]
1 a 6mm	$0,0,z$ [$0,0,0$]		

Symmetry of special projections

Along [001] 6mm	Along [100] $\rho 11m1'$	Along [210] $\rho 11m1'$
Origin at 0,0,z	$a^* = c$ Origin at $x,0,0$	$a^* = c$ Origin at $x,x/2,0$

$p6mm1'$

$6mm1'$

Hexagonal

No. 68.2.342

$p6mm1'$

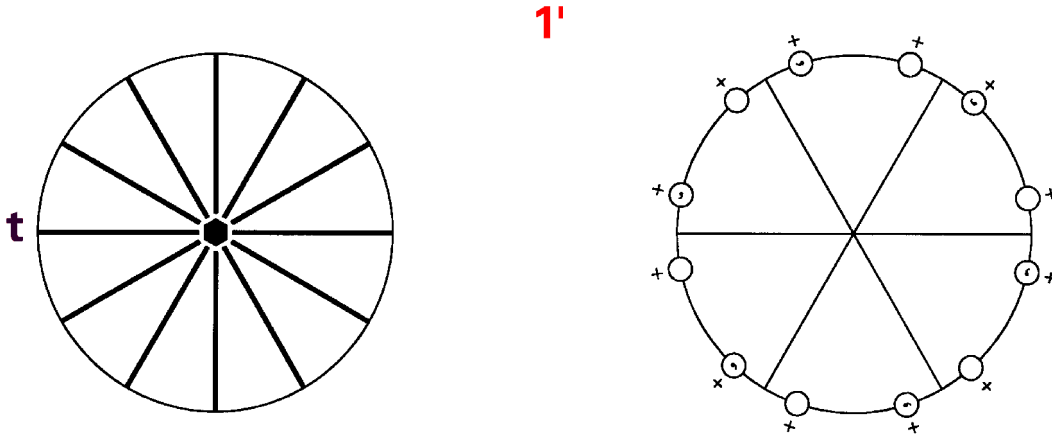

Origin on $6mm1'$

Asymmetric unit $0 \leq x; 0 \leq y; 0 \leq z \leq 1; y \leq x/2$

Symmetry operations

For $1 +$ set

- | | | |
|---|---|---|
| (1) 1
($1 0,0,0$) | (2) 3^+ $0,0,z$
($3_z 0,0,0$) | (3) 3^- $0,0,z$
($3_z^{-1} 0,0,0$) |
| (4) 2 $0,0,z$
($2_z 0,0,0$) | (5) 6^- $0,0,z$
($6_z^{-1} 0,0,0$) | (6) 6^+ $0,0,z$
($6_z 0,0,0$) |
| (7) m x,\bar{x},z
($m_{xy} 0,0,0$) | (8) m $x,2x,z$
($m_x 0,0,0$) | (9) m $2x,x,z$
($m_y 0,0,0$) |
| (10) m x,x,z
($m_3 0,0,0$) | (11) m $x,0,z$
($m_2 0,0,0$) | (12) m $0,y,z$
($m_1 0,0,0$) |

For $1' +$ set

- | | | |
|---|---|---|
| (1) $1'$
($1 0,0,0$)' | (2) $3^{+'}$ $0,0,z$
($3_z 0,0,0$)' | (3) $3^{-'}$ $0,0,z$
($3_z^{-1} 0,0,0$)' |
| (4) $2'$ $0,0,z$
($2_z 0,0,0$)' | (5) $6^{-'}$ $0,0,z$
($6_z^{-1} 0,0,0$)' | (6) $6^{+'}$ $0,0,z$
($6_z 0,0,0$)' |
| (7) m' x,\bar{x},z
($m_{xy} 0,0,0$)' | (8) m' $x,2x,z$
($m_x 0,0,0$)' | (9) m' $2x,x,z$
($m_y 0,0,0$)' |
| (10) m' x,x,z
($m_3 0,0,0$)' | (11) m' $x,0,z$
($m_2 0,0,0$)' | (12) m' $0,y,z$
($m_1 0,0,0$)' |

Generators selected (1); $t(0,0,1)$; (2); (4); (7); $1'$

Positions

Multiplicity, Wyckoff letter, Site symmetry	Coordinates		
	$1+$	$1'+$	
12 d $11'$	(1) x,y,z [0,0,0] (4) \bar{x},\bar{y},z [0,0,0] (7) \bar{y},\bar{x},z [0,0,0] (10) y,x,z [0,0,0]	(2) $\bar{y},x-y,z$ [0,0,0] (5) $y,\bar{x}+y,z$ [0,0,0] (8) $\bar{x}+y,y,z$ [0,0,0] (11) $x-y,\bar{y},z$ [0,0,0]	(3) $\bar{x}+y,\bar{x},z$ [0,0,0] (6) $x-y,x,z$ [0,0,0] (9) $x,x-y,z$ [0,0,0] (12) $\bar{x},\bar{x}+y,z$ [0,0,0]
6 c $.m.1'$	x,\bar{x},z [0,0,0] \bar{x},x,z [0,0,0]	$x,2x,z$ [0,0,0] $\bar{x},2\bar{x},z$ [0,0,0]	$2\bar{x},\bar{x},z$ [0,0,0] $2x,x,z$ [0,0,0]
6 b $..m1'$	$x,0,z$ [0,0,0] $\bar{x},0,z$ [0,0,0]	$0,x,z$ [0,0,0] $0,\bar{x},z$ [0,0,0]	\bar{x},\bar{x},z [0,0,0] x,x,z [0,0,0]
1 a $6mm1'$	$0,0,0$ [0,0,0]		

Symmetry of special projections

Along [001] $6mm1'$	Along [100] $p11m1'$	Along [210] $p11m1'$
Origin at 0,0,z	$a^* = c$ Origin at $x,0,0$	$a^* = c$ Origin at $x,x/2,0$

$\rho 6m'm'$

No. 68.3.343

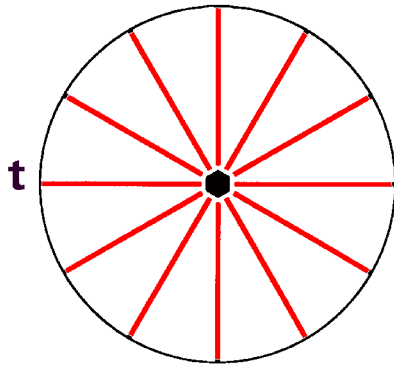

$6m'm'$

$\rho 6m'm'$

Hexagonal

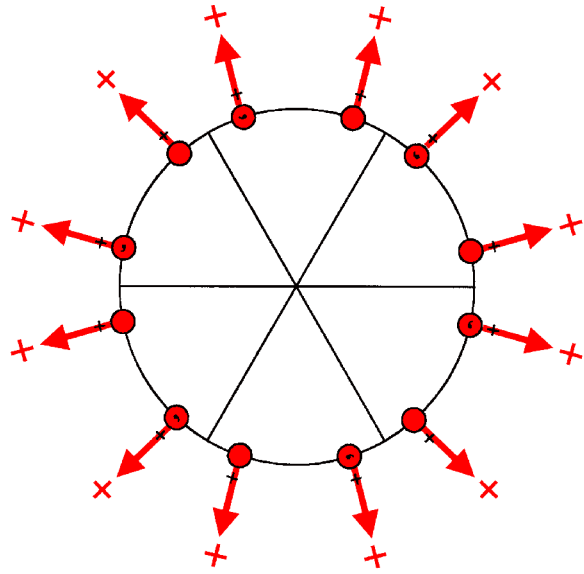

Origin on $6m'm'$

Asymmetric unit $0 \leq x; 0 \leq y; 0 \leq z \leq 1; y \leq x/2$

Symmetry operations

- | | | |
|---|---|---|
| (1) 1
(1 0,0,0) | (2) 3^+ 0,0,z
(3_z 0,0,0) | (3) 3^- 0,0,z
(3_z^{-1} 0,0,0) |
| (4) 2 0,0,z
(2_z 0,0,0) | (5) 6^- 0,0,z
(6_z^{-1} 0,0,0) | (6) 6^+ 0,0,z
(6_z 0,0,0) |
| (7) m' x, \bar{x} ,z
(m_{xy} 0,0,0)' | (8) m' x,2x,z
(m_x 0,0,0)' | (9) m' 2x,x,z
(m_y 0,0,0)' |
| (10) m' x,x,z
(m_3 0,0,0)' | (11) m' x,0,z
(m_2 0,0,0)' | (12) m' 0,y,z
(m_1 0,0,0)' |

Generators selected (1); $t(0,0,1)$; (2); (4); (7)

Positions

Multiplicity, Wyckoff letter, Site symmetry	Coordinates		
12 d 1	(1) $x,y,z [u,v,w]$	(2) $\bar{y},x-y,z [\bar{v},u-v,w]$	(3) $\bar{x}+y,\bar{x},z [\bar{u}+v,\bar{u},w]$
	(4) $\bar{x},\bar{y},z [\bar{u},\bar{v},w]$	(5) $y,\bar{x}+y,z [v,\bar{u}+v,w]$	(6) $x-y,x,z [u-v,u,w]$
	(7) $\bar{y},\bar{x},z [\bar{v},\bar{u},w]$	(8) $\bar{x}+y,y,z [\bar{u}+v,v,w]$	(9) $x,x-y,z [u,u-v,w]$
	(10) $y,x,z [v,u,w]$	(11) $x-y,\bar{y},z [u-v,\bar{v},w]$	(12) $\bar{x},\bar{x}+y,z [\bar{u},\bar{u}+v,w]$
6 c \bar{m}'	$x,\bar{x},z [u,\bar{u},w]$	$x,2x,z [u,2u,w]$	$2\bar{x},\bar{x},z [2\bar{u},\bar{u},w]$
	$\bar{x},x,z [\bar{u},u,w]$	$\bar{x},2\bar{x},z [\bar{u},2\bar{u},w]$	$2x,x,z [2u,u,w]$
6 b \bar{m}'	$x,0,z [u,0,w]$	$0,x,z [0,u,w]$	$\bar{x},\bar{x},z [\bar{u},\bar{u},w]$
	$\bar{x},0,z [\bar{u},0,w]$	$0,\bar{x},z [0,\bar{u},w]$	$x,x,z [u,u,w]$
1 a $6m'm'$	$0,0,z [0,0,w]$		

Symmetry of special projections

Along [001] $6m'm'$	Along [100] $\rho 11m'$	Along [210] $\rho 11m'$
Origin at 0,0,z	$a^* = c$ Origin at $x,0,0$	$a^* = c$ Origin at $x,x/2,0$

$p6'mm'$

No. 68.4.344

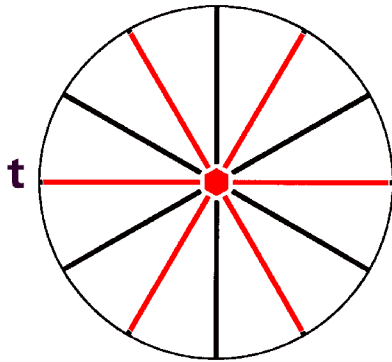

$6'mm'$

$p6'mm'$

Hexagonal

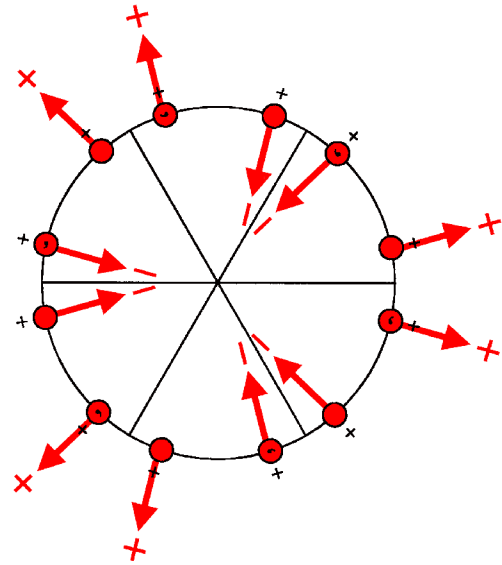

Origin on $6'mm'$

Asymmetric unit $0 \leq x; 0 \leq y; 0 \leq z \leq 1; y \leq x/2$

Symmetry operations

- | | | |
|---|--|---|
| (1) 1
(1 0,0,0) | (2) 3^+ 0,0,z
(3_z 0,0,0) | (3) 3^- 0,0,z
(3_z^{-1} 0,0,0) |
| (4) $2'$ 0,0,z
(2_z 0,0,0)' | (5) 6^- 0,0,z
(6_z^{-1} 0,0,0)' | (6) 6^+ 0,0,z
(6_z 0,0,0)' |
| (7) m x, \bar{x} ,z
(m_{xy} 0,0,0) | (8) m x,2x,z
(m_x 0,0,0) | (9) m 2x,x,z
(m_y 0,0,0) |
| (10) m' x,x,z
(m_3 0,0,0)' | (11) m' x,0,z
(m_2 0,0,0)' | (12) m' 0,y,z
(m_1 0,0,0)' |

Generators selected (1); $t(0,0,1)$; (2); (4); (7)

Positions

Multiplicity, Wyckoff letter, Site symmetry	Coordinates		
12 d 1	(1) x,y,z [u,v,w]	(2) $\bar{y},x-y,z$ [$\bar{v},u-v,w$]	(3) $\bar{x}+y,\bar{x},z$ [$\bar{u}+v,\bar{u},w$]
	(4) \bar{x},\bar{y},z [u,v,\bar{w}]	(5) $y,\bar{x}+y,z$ [$\bar{v},u-v,\bar{w}$]	(6) $x-y,x,z$ [$\bar{u}+v,\bar{u},\bar{w}$]
	(7) \bar{y},\bar{x},z [v,u,\bar{w}]	(8) $\bar{x}+y,y,z$ [$u-v,\bar{v},\bar{w}$]	(9) $x,x-y,z$ [$\bar{u},\bar{u}+v,\bar{w}$]
	(10) y,x,z [v,u,w]	(11) $x-y,\bar{y},z$ [$u-v,\bar{v},w$]	(12) $\bar{x},\bar{x}+y,z$ [$\bar{u},\bar{u}+v,w$]
6 c .m.	x,\bar{x},z [$u,u,0$]	$x,2x,z$ [$\bar{u},0,0$]	$2\bar{x},\bar{x},z$ [$0,\bar{u},0$]
	\bar{x},x,z [$u,u,0$]	$\bar{x},2\bar{x},z$ [$\bar{u},0,0$]	$2x,x,z$ [$0,\bar{u},0$]
6 b ..m'	$x,0,z$ [$u,0,w$]	$0,x,z$ [$0,u,w$]	\bar{x},\bar{x},z [\bar{u},\bar{u},w]
	$\bar{x},0,z$ [$u,0,\bar{w}$]	$0,\bar{x},z$ [$0,u,\bar{w}$]	x,x,z [\bar{u},\bar{u},\bar{w}]
1 a 6'mm'	$0,0,z$ [$0,0,0$]		

Symmetry of special projections

Along [001] $6'mm'$	Along [100] $p11m1'$	Along [210] $p11m$
Origin at $0,0,z$	$a^* = c$ Origin at $x,0,0$	$a^* = c$ Origin at $x,x/2,0$

$\rho_{2c} 6m'm'$

$6mm1'$

Hexagonal

No. 68.5.345

$\rho_{2c} 6m'm'$

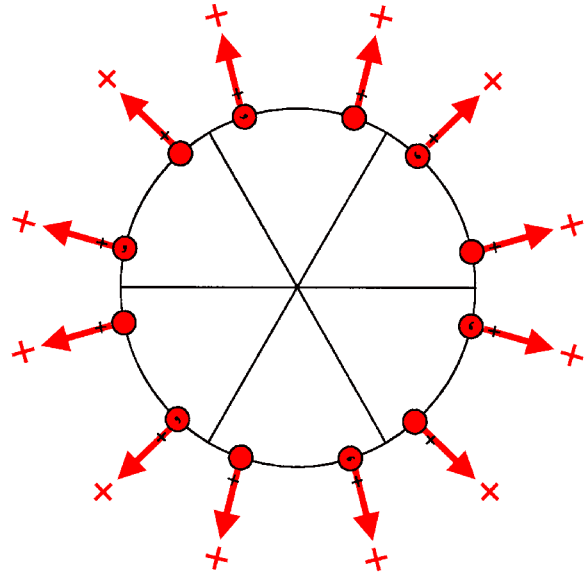
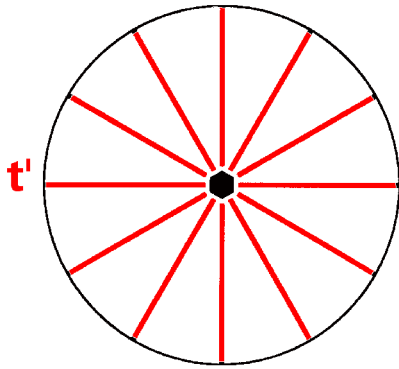

Origin on $6m'm'$

Asymmetric unit $0 \leq x; 0 \leq y; 0 \leq z \leq 1; y \leq x/2$

Symmetry operations

For $(0,0,0) +$ set

- | | | |
|---|---|---|
| (1) 1
(1 0,0,0) | (2) 3^+ 0,0,z
(3_z 0,0,0) | (3) 3^- 0,0,z
(3_z^{-1} 0,0,0) |
| (4) 2 0,0,z
(2_z 0,0,0) | (5) 6^- 0,0,z
(6_z^{-1} 0,0,0) | (6) 6^+ 0,0,z
(6_z 0,0,0) |
| (7) m' x, \bar{x} ,z
(m_{xy} 0,0,0)' | (8) m' x,2x,z
(m_x 0,0,0)' | (9) m' 2x,x,z
(m_y 0,0,0)' |
| (10) m' x,x,z
(m_3 0,0,0)' | (11) m' x,0,z
(m_2 0,0,0)' | (12) m' 0,y,z
(m_1 0,0,0)' |

For $(0,0,1) +$ set

- | | | |
|--|---|---|
| (1) t' (0,0,1)
(1 0,0,1)' | (2) 3^{+-} (0,0,1) 0,0,z
(3_z 0,0,1)' | (3) 3^{-+} (0,0,1) 0,0,z
(3_z^{-1} 0,0,1)' |
| (4) $2'$ (0,0,1) 0,0,z
(2_z 0,0,1)' | (5) 6^{-+} (0,0,1) 0,0,z
(6_z^{-1} 0,0,1)' | (6) 6^{+-} (0,0,1) 0,0,z
(6_z 0,0,1)' |
| (7) c (0,0,1) x, \bar{x} ,z
(m_{xy} 0,0,1)' | (8) c (0,0,1) x,2x,z
(m_x 0,0,1)' | (9) c (0,0,1) 2x,x,z
(m_y 0,0,1)' |
| (10) c (0,0,1) x,x,z
(m_3 0,0,1)' | (11) c (0,0,1) x,0,z
(m_2 0,0,1)' | (12) c (0,0,1) 0,y,z
(m_1 0,0,1)' |

Generators selected (1); $t(0,0,1)'$; (2); (4); (7)

Positions

Multiplicity, Wyckoff letter, Site symmetry	Coordinates		
		(0,0,0)+	(0,0,1)' +
12 d 1	(1) $x,y,z [u,v,w]$	(2) $\bar{y},x-y,z [\bar{v},u-v,w]$	(3) $\bar{x}+y,\bar{x},z [\bar{u}+v,\bar{u},w]$
	(4) $\bar{x},\bar{y},z [\bar{u},\bar{v},w]$	(5) $y,\bar{x}+y,z [v,\bar{u}+v,w]$	(6) $x-y,x,z [u-v,u,w]$
	(7) $\bar{y},\bar{x},z [\bar{v},\bar{u},w]$	(8) $\bar{x}+y,y,z [\bar{u}+v,v,w]$	(9) $x,x-y,z [u,u-v,w]$
	(10) $y,x,z [v,u,w]$	(11) $x-y,\bar{y},z [u-v,\bar{v},w]$	(12) $\bar{x},\bar{x}+y,z [\bar{u},\bar{u}+v,w]$
6 c $..m'$	$x,\bar{x},z [u,\bar{u},w]$	$x,2x,z [u,2u,w]$	$2\bar{x},\bar{x},z [2\bar{u},\bar{u},w]$
	$\bar{x},x,z [\bar{u},u,w]$	$\bar{x},2\bar{x},z [\bar{u},2\bar{u},w]$	$2x,x,z [2u,u,w]$
6 b $..m'$	$x,0,z [u,0,w]$	$0,x,z [0,u,w]$	$\bar{x},\bar{x},z [\bar{u},\bar{u},w]$
	$\bar{x},0,z [\bar{u},0,w]$	$0,\bar{x},z [0,\bar{u},w]$	$x,x,z [u,u,w]$
1 a $6m'm'$	$0,0,z [0,0,w]$		

Symmetry of special projections

Along [001] $6mm1'$	Along [100] $\rho_{2a^*} 11m'$	Along [210] $\rho_{2a^*} 11m'$
Origin at 0,0,z	$a^* = c$ Origin at $x,0,0$	$a^* = c$ Origin at $x,x/2,0$

$\rho_{2c} 6'mm'$

$6mm1'$

Hexagonal

No. 68.6.346

$\rho_{2c} 6'mm'$

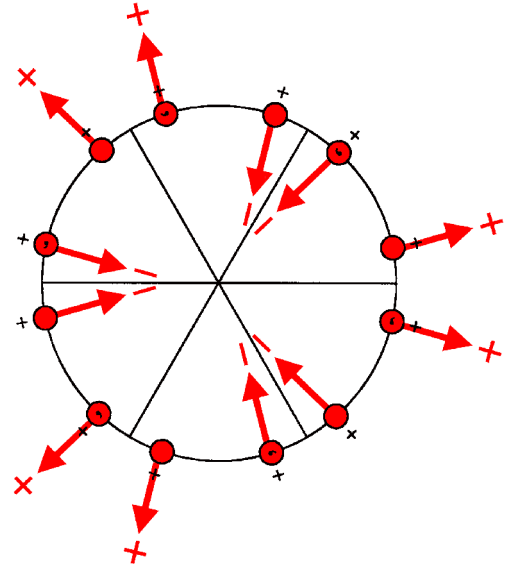
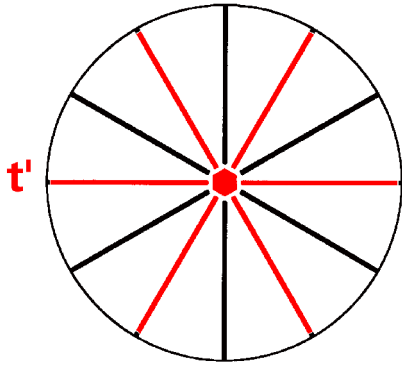

Origin on $6'mm'$

Asymmetric unit $0 \leq x; 0 \leq y; 0 \leq z \leq 1; y \leq x/2$

Symmetry operations

- | | | |
|---|---|---|
| (1) 1
(1 0,0,0) | (2) 3^+ 0,0,z
(3_z 0,0,0) | (3) 3^- 0,0,z
(3_z^{-1} 0,0,0) |
| (4) $2'$ 0,0,z
(2_z 0,0,0)' | (5) 6^- 0,0,z
(6_z^{-1} 0,0,0)' | (6) 6^+ 0,0,z
(6_z 0,0,0)' |
| (7) m x, \bar{x}, z
(m_{xy} 0,0,0) | (8) m $x, 2x, z$
(m_x 0,0,0) | (9) m $2x, x, z$
(m_y 0,0,0) |
| (10) m' x, x, z
(m_3 0,0,0)' | (11) m' $x, 0, z$
(m_2 0,0,0)' | (12) m' $0, y, z$
(m_1 0,0,0)' |
| For (0,0,1)' + set | | |
| (1) t' (0,0,1)
(1 0,0,1)' | (2) $3^{+'}$ (0,0,1) 0,0,z
(3_z 0,0,1)' | (3) $3^{-'}$ (0,0,1) 0,0,z
(3_z^{-1} 0,0,1)' |
| (4) 2 (0,0,1) 0,0,z
(2_z 0,0,1) | (5) 6^- (0,0,1) 0,0,z
(6_z^{-1} 0,0,1) | (6) 6^+ (0,0,1) 0,0,z
(6_z 0,0,1) |
| (7) c' (0,0,1) x, \bar{x}, z
(m_{xy} 0,0,1)' | (8) c' (0,0,1) $x, 2x, z$
(m_x 0,0,1)' | (9) c' (0,0,1) $2x, x, z$
(m_y 0,0,1)' |
| (10) c (0,0,1) x, x, z
(m_3 0,0,1) | (11) c (0,0,1) $x, 0, z$
(m_2 0,0,1) | (12) c (0,0,1) $0, y, z$
(m_1 0,0,1) |

Generators selected (1); $t(0,0,1)'$; (2); (4); (7)

Positions

Multiplicity, Wyckoff letter, Site symmetry	Coordinates		
		(0,0,0)+	(0,0,1)' +
12 d 1	(1) $x,y,z [u,v,w]$	(2) $\bar{y},x-y,z [\bar{v},u-v,w]$	(3) $\bar{x}+y,\bar{x},z [\bar{u}+v,\bar{u},w]$
	(4) $\bar{x},\bar{y},z [u,v,\bar{w}]$	(5) $y,\bar{x}+y,z [\bar{v},u-v,\bar{w}]$	(6) $x-y,x,z [\bar{u}+v,\bar{u},\bar{w}]$
	(7) $\bar{y},\bar{x},z [v,u,\bar{w}]$	(8) $\bar{x}+y,y,z [u-v,\bar{v},\bar{w}]$	(9) $x,x-y,z [\bar{u},\bar{u}+v,\bar{w}]$
	(10) $y,x,z [v,u,w]$	(11) $x-y,\bar{y},z [u-v,\bar{v},w]$	(12) $\bar{x},\bar{x}+y,z [\bar{u},\bar{u}+v,w]$
6 c .m.	$x,\bar{x},z [u,u,0]$	$x,2x,z [\bar{u},0,0]$	$2\bar{x},\bar{x},z [0,\bar{u},0]$
	$\bar{x},x,z [u,u,0]$	$\bar{x},2\bar{x},z [\bar{u},0,0]$	$2x,x,z [0,\bar{u},0]$
6 b ..m'	$x,0,z [u,0,w]$	$0,x,z [0,u,w]$	$\bar{x},\bar{x},z [\bar{u},\bar{u},w]$
	$\bar{x},0,z [u,0,\bar{w}]$	$0,\bar{x},z [0,u,\bar{w}]$	$x,x,z [\bar{u},\bar{u},\bar{w}]$
1 a 6'mm'	$0,0,z [0,0,0]$		

Symmetry of special projections

Along [001] $6mm1'$	Along [100] $p11m1'$	Along [210] $p_{2a^*} 11m$
Origin at 0,0,z	$a^* = c$ Origin at $x,0,0$	$a^* = c$ Origin at $x,x/2,0$

$\rho_{2c} 6mm$

$6mm1'$

Hexagonal

No. 68.7.347

$\rho_{2c} 6mm$

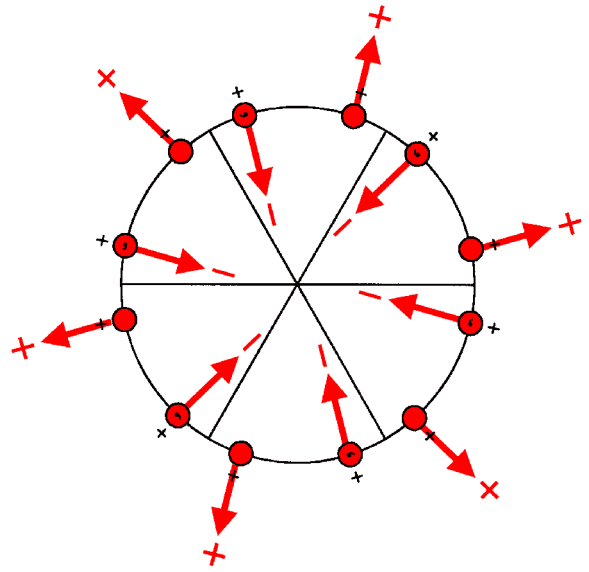
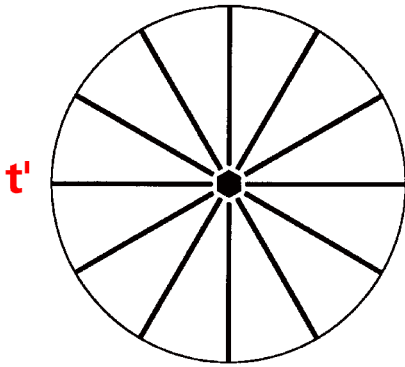

Origin on $6mm$

Asymmetric unit $0 \leq x; 0 \leq y; 0 \leq z \leq 1; y \leq x/2$

Symmetry operations

- | | | |
|---|---|---|
| (1) 1
(1 0,0,0) | (2) 3^+ 0,0,z
(3_z 0,0,0) | (3) 3^- 0,0,z
(3_z^{-1} 0,0,0) |
| (4) 2 0,0,z
(2_z 0,0,0) | (5) 6^- 0,0,z
(6_z^{-1} 0,0,0) | (6) 6^+ 0,0,z
(6_z 0,0,0) |
| (7) m x, \bar{x}, z
(m_{xy} 0,0,0) | (8) m $x, 2x, z$
(m_x 0,0,0) | (9) m $2x, x, z$
(m_y 0,0,0) |
| (10) m x, x, z
(m_3 0,0,0) | (11) m $x, 0, z$
(m_2 0,0,0) | (12) m $0, y, z$
(m_1 0,0,0) |
| For (0,0,1)' + set | | |
| (1) t' (0,0,1)
(1 0,0,1)' | (2) $3^{+'}$ (0,0,1) 0,0,z
(3_z 0,0,1)' | (3) $3^{-'}$ (0,0,1) 0,0,z
(3_z^{-1} 0,0,1)' |
| (4) 2' (0,0,1) 0,0,z
(2_z 0,0,1)' | (5) $6^{-'}$ (0,0,1) 0,0,z
(6_z^{-1} 0,0,1)' | (6) $6^{+'}$ (0,0,1) 0,0,z
(6_z 0,0,1)' |
| (7) c' (0,0,1) x, \bar{x}, z
(m_{xy} 0,0,1)' | (8) c' (0,0,1) $x, 2x, z$
(m_x 0,0,1)' | (9) c' (0,0,1) $2x, x, z$
(m_y 0,0,1)' |
| (10) c' (0,0,1) x, x, z
(m_3 0,0,1)' | (11) c' (0,0,1) $x, 0, z$
(m_2 0,0,1)' | (12) c' (0,0,1) $0, y, z$
(m_1 0,0,1)' |

Generators selected (1); $t(0,0,1)'$; (2); (4); (7)

Positions

Multiplicity, Wyckoff letter, Site symmetry	Coordinates		
	(0,0,0)+	(0,0,1)' +	
12 d 1	(1) $x,y,z [u,v,w]$ (4) $\bar{x},\bar{y},z [\bar{u},\bar{v},w]$ (7) $\bar{y},\bar{x},z [v,u,\bar{w}]$ (10) $y,x,z [\bar{v},\bar{u},\bar{w}]$	(2) $\bar{y},x-y,z [\bar{v},u-v,w]$ (5) $y,\bar{x}+y,z [v,\bar{u}+v,w]$ (8) $\bar{x}+y,y,z [u-v,\bar{v},\bar{w}]$ (11) $x-y,\bar{y},z [\bar{u}+v,v,\bar{w}]$	(3) $\bar{x}+y,\bar{x},z [\bar{u}+v,\bar{u},w]$ (6) $x-y,x,z [u-v,u,w]$ (9) $x,x-y,z [\bar{u},\bar{u}+v,\bar{w}]$ (12) $\bar{x},\bar{x}+y,z [u,u-v,\bar{w}]$
6 c .m.	$x,\bar{x},z [u,u,0]$ $\bar{x},x,z [\bar{u},\bar{u},0]$	$x,2x,z [\bar{u},0,0]$ $\bar{x},2\bar{x},z [u,0,0]$	$2\bar{x},\bar{x},z [0,\bar{u},0]$ $2x,x,z [0,u,0]$
6 b ..m	$x,0,z [u,2u,0]$ $\bar{x},0,z [\bar{u},2\bar{u},0]$	$0,x,z [2\bar{u},\bar{u},0]$ $0,\bar{x},z [2u,u,0]$	$\bar{x},\bar{x},z [u,\bar{u},0]$ $x,x,z [\bar{u},u,0]$
1 a 6mm	$0,0,z [0,0,0]$		

Symmetry of special projections

Along [001] 6mm1'	Along [100] $p11m1'$ $a^* = c$	Along [210] $p11m1'$ $a^* = c$
Origin at 0,0,z	Origin at $x,0,0$	Origin at $x,x/2,0$

$p6cc$

$6mm$

Hexagonal

No. 69.1.348

$p6cc$

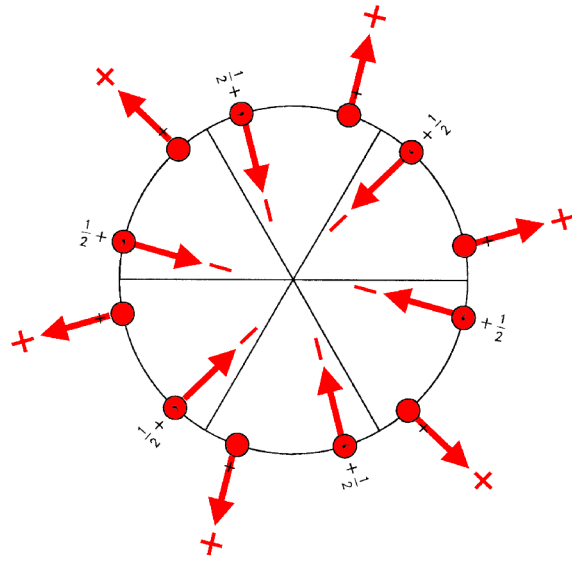
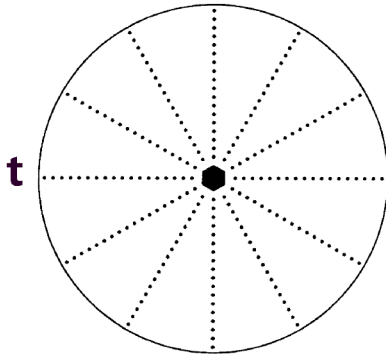

Origin on $6cc$

Asymmetric unit $0 \leq x$; $0 \leq y$; $0 \leq z \leq 1/2$; $y \leq x$

Symmetry operations

- | | | |
|---|---|---|
| (1) 1
(1 0,0,0) | (2) 3^+ 0,0,z
(3_z 0,0,0) | (3) 3^- 0,0,z
(3_z^{-1} 0,0,0) |
| (4) 2 0,0,z
(2_z 0,0,0) | (5) 6^- 0,0,z
(6_z^{-1} 0,0,0) | (6) 6^+ 0,0,z
(6_z 0,0,0) |
| (7) c (0,0,1/2) x, \bar{x} ,z
(m_{xy} 0,0,1/2) | (8) c (0,0,1/2) x,2x,z
(m_x 0,0,1/2) | (9) c (0,0,1/2) 2x,x,z
(m_y 0,0,1/2) |
| (10) c (0,0,1/2) x,x,z
(m_3 0,0,1/2) | (11) c (0,0,1/2) x,0,z
(m_2 0,0,1/2) | (12) c (0,0,1/2) 0,y,z
(m_1 0,0,1/2) |

Generators selected (1); t(0,0,1); (2); (4); (7)

Positions

Multiplicity, Wyckoff letter, Site symmetry	Coordinates		
	(1) x,y,z [u,v,w]	(2) $\bar{y},x-y,z$ [$\bar{v},u-v,w$]	(3) $\bar{x}+y,\bar{x},z$ [$\bar{u}+v,\bar{u},w$]
12 b 1	(4) \bar{x},\bar{y},z [\bar{u},\bar{v},w]	(5) $y,\bar{x}+y,z$ [$v,\bar{u}+v,w$]	(6) x-y,x,z [u-v,u,w]
	(7) $\bar{y},\bar{x},z+1/2$ [v,u,\bar{w}]	(8) $\bar{x}+y,y,z+1/2$ [$u-v,\bar{v},\bar{w}$]	(9) x,x-y,z+1/2 [$\bar{u},\bar{u}+v,\bar{w}$]
	(10) $y,x,z+1/2$ [\bar{v},\bar{u},\bar{w}]	(11) x-y, $\bar{y},z+1/2$ [$\bar{u}+v,v,\bar{w}$]	(12) $\bar{x},\bar{x}+y,z+1/2$ [$u,u-v,\bar{w}$]
2 a 6..	0,0,z [0,0,w]	0,0,z+1/2 [0,0, \bar{w}]	

Symmetry of special projections

Along [001] 6mm	Along [100] p_{2a^*} 11m'	Along [210] p_{2a^*} 11m'
Origin at 0,0,z	$a^* = c/2$ Origin at x,0,0	$a^* = c/2$ Origin at x,x/2,0

$p6cc1'$

$6mm1'$

Hexagonal

No. 69.2.349

$p6cc1'$

1'

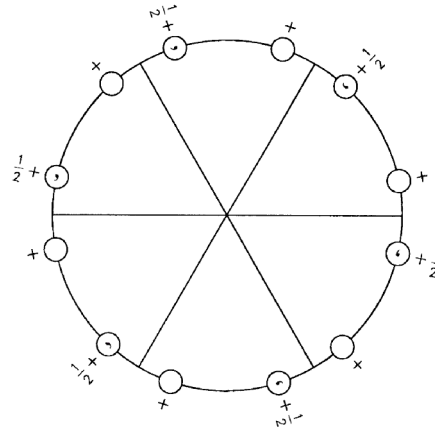
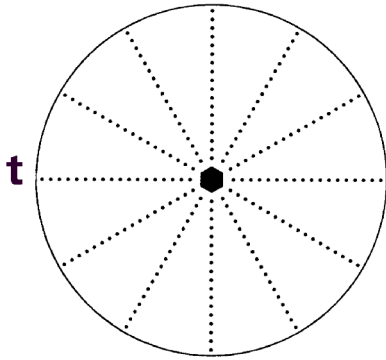

Origin on $6cc1'$

Asymmetric unit $0 \leq x$; $0 \leq y$; $0 \leq z \leq 1/2$; $y \leq x$

Symmetry operations

For $1 +$ set

- | | | |
|---|---|---|
| (1) 1
($1 0,0,0$) | (2) 3^+ $0,0,z$
($3_z 0,0,0$) | (3) 3^- $0,0,z$
($3_z^{-1} 0,0,0$) |
| (4) 2 $0,0,z$
($2_z 0,0,0$) | (5) 6^- $0,0,z$
($6_z^{-1} 0,0,0$) | (6) 6^+ $0,0,z$
($6_z 0,0,0$) |
| (7) c $(0,0,1/2)$ x,\bar{x},z
($m_{xy} 0,0,1/2$) | (8) c $(0,0,1/2)$ $x,2x,z$
($m_x 0,0,1/2$) | (9) c $(0,0,1/2)$ $2x,x,z$
($m_y 0,0,1/2$) |
| (10) c $(0,0,1/2)$ x,x,z
($m_3 0,0,1/2$) | (11) c $(0,0,1/2)$ $x,0,z$
($m_2 0,0,1/2$) | (12) c $(0,0,1/2)$ $0,y,z$
($m_1 0,0,1/2$) |

For $1' +$ set

- | | | |
|---|---|---|
| (1) $1'$
($1 0,0,0$)' | (2) $3^{+'}$ $0,0,z$
($3_z 0,0,0$)' | (3) $3^{-'}$ $0,0,z$
($3_z^{-1} 0,0,0$)' |
| (4) $2'$ $0,0,z$
($2_z 0,0,0$)' | (5) $6^{-'}$ $0,0,z$
($6_z^{-1} 0,0,0$)' | (6) $6^{+'}$ $0,0,z$
($6_z 0,0,0$)' |
| (7) c' $(0,0,1/2)$ x,\bar{x},z
($m_{xy} 0,0,1/2$)' | (8) c' $(0,0,1/2)$ $x,2x,z$
($m_x 0,0,1/2$)' | (9) c' $(0,0,1/2)$ $2x,x,z$
($m_y 0,0,1/2$)' |
| (10) c' $(0,0,1/2)$ x,x,z
($m_3 0,0,1/2$)' | (11) c' $(0,0,1/2)$ $x,0,z$
($m_2 0,0,1/2$)' | (12) c' $(0,0,1/2)$ $0,y,z$
($m_1 0,0,1/2$)' |

Generators selected (1); t(0,0,1); (2); (4); (7); 1'

Positions

Multiplicity, Wyckoff letter, Site symmetry	Coordinates		
	1+	1' +	
12 b 11'	(1) x,y,z [0,0,0]	(2) $\bar{y},x-y,z$ [0,0,0]	(3) $\bar{x}+y,\bar{x},z$ [0,0,0]
	(4) \bar{x},\bar{y},z [0,0,0]	(5) $y,\bar{x}+y,z$ [0,0,0]	(6) x-y,x,z [0,0,0]
	(7) $\bar{y},\bar{x},z+1/2$ [0,0,0]	(8) $\bar{x}+y,y,z+1/2$ [0,0,0]	(9) x,x-y,z+1/2 [0,0,0]
	(10) y,x,z+1/2 [0,0,0]	(11) x-y, $\bar{y},z+1/2$ [0,0,0]	(12) $\bar{x},\bar{x}+y,z+1/2$ [0,0,0]
2 a 6..1'	0,0,z [0,0,0]	0,0,z+1/2 [0,0,0]	

Symmetry of special projections

Along [001] 6mm1'	Along [100] p11m1' a* = c/2	Along [210] p11m1' a* = c/2
Origin at 0,0,z	Origin at x,0,0	Origin at x,x/2,0

$p6c'c'$

No. 69.3.350

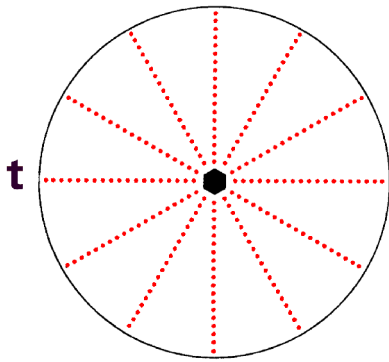

$6m'm'$

$p6c'c'$

Hexagonal

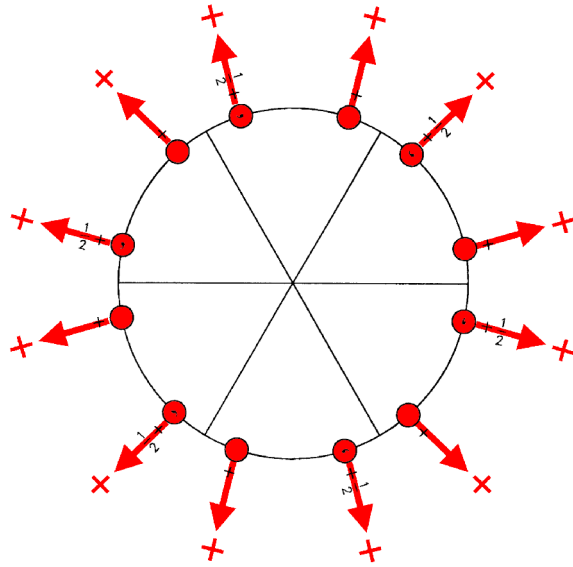

Origin on $6c'c'$

Asymmetric unit $0 \leq x; 0 \leq y; 0 \leq z \leq 1/2; y \leq x$

Symmetry operations

- | | | |
|---|---|---|
| (1) 1
(1 0,0,0) | (2) 3^+ 0,0,z
(3_z 0,0,0) | (3) 3^- 0,0,z
(3_z^{-1} 0,0,0) |
| (4) 2 0,0,z
(2_z 0,0,0) | (5) 6^- 0,0,z
(6_z^{-1} 0,0,0) | (6) 6^+ 0,0,z
(6_z 0,0,0) |
| (7) c' (0,0,1/2) x, \bar{x}, z
(m_{xy} 0,0,1/2)' | (8) c' (0,0,1/2) $x, 2x, z$
(m_x 0,0,1/2)' | (9) c' (0,0,1/2) $2x, x, z$
(m_y 0,0,1/2)' |
| (10) c' (0,0,1/2) x, x, z
(m_3 0,0,1/2)' | (11) c' (0,0,1/2) $x, 0, z$
(m_2 0,0,1/2)' | (12) c' (0,0,1/2) $0, y, z$
(m_1 0,0,1/2)' |

Generators selected (1); t(0,0,1); (2); (4); (7)

Positions

Multiplicity, Wyckoff letter, Site symmetry	Coordinates		
	(1) x,y,z [u,v,w]	(2) $\bar{y},x-y,z$ [$\bar{v},u-v,w$]	(3) $\bar{x}+y,\bar{x},z$ [$\bar{u}+v,\bar{u},w$]
12 b 1	(4) \bar{x},\bar{y},z [\bar{u},\bar{v},w]	(5) $y,\bar{x}+y,z$ [$v,\bar{u}+v,w$]	(6) x-y,x,z [u-v,u,w]
	(7) $\bar{y},\bar{x},z+1/2$ [\bar{v},\bar{u},w]	(8) $\bar{x}+y,y,z+1/2$ [$\bar{u}+v,v,w$]	(9) x,x-y,z+1/2 [u,u-v,w]
	(10) y,x,z+1/2 [v,u,w]	(11) x-y, $\bar{y},z+1/2$ [u-v, \bar{v},w]	(12) $\bar{x},\bar{x}+y,z+1/2$ [$\bar{u},\bar{u}+v,w$]
	2 a 6..	0,0,z [0,0,w]	0,0,z+1/2 [0,0,w]

Symmetry of special projections

Along [001] 6m'm'	Along [100] p11m' a* = c/2	Along [210] p11m' a* = c/2
Origin at 0,0,z	Origin at x,0,0	Origin at x,x/2,0

$p6'cc'$

No. 69.4.351

$6'mm'$

$p6'cc'$

Hexagonal

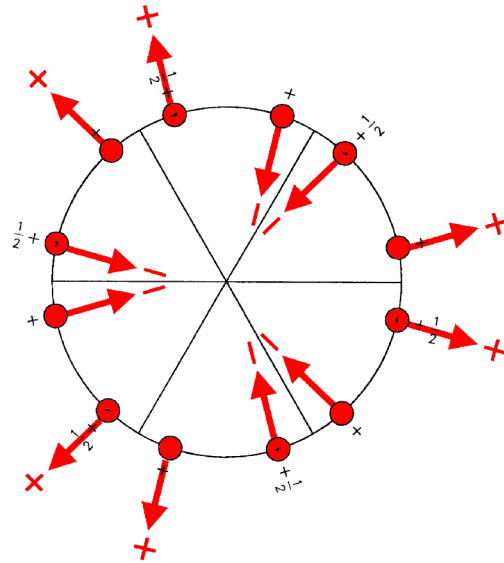
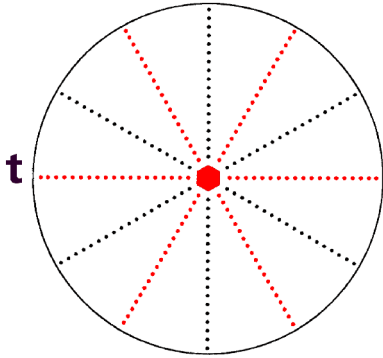

Origin on $6'cc'$

Asymmetric unit $0 \leq x; 0 \leq y; 0 \leq z \leq 1/2; y \leq x$

Symmetry operations

- | | | |
|---|---|---|
| (1) 1
(1 0,0,0) | (2) 3^+ 0,0,z
(3_z 0,0,0) | (3) 3^- 0,0,z
(3_z^{-1} 0,0,0) |
| (4) $2'$ 0,0,z
(2_z 0,0,0)' | (5) 6^- 0,0,z
(6_z^{-1} 0,0,0)' | (6) 6^+ 0,0,z
(6_z 0,0,0)' |
| (7) c (0,0,1/2) x, \bar{x} ,z
(m_{xy} 0,0,1/2) | (8) c (0,0,1/2) x,2x,z
(m_x 0,0,1/2) | (9) c (0,0,1/2) 2x,x,z
(m_y 0,0,1/2) |
| (10) c' (0,0,1/2) x,x,z
(m_3 0,0,1/2)' | (11) c' (0,0,1/2) x,0,z
(m_2 0,0,1/2)' | (12) c' (0,0,1/2) 0,y,z
(m_1 0,0,1/2)' |

Generators selected (1); $t(0,0,1)$; (2); (4); (7)

Positions

Multiplicity, Wyckoff letter, Site symmetry	Coordinates		
	(1) x,y,z [u,v,w]	(2) $\bar{y},x-y,z$ [$\bar{v},u-v,w$]	(3) $\bar{x}+y,\bar{x},z$ [$\bar{u}+v,\bar{u},w$]
12 b 1	(4) \bar{x},\bar{y},z [u,v,\bar{w}]	(5) $y,\bar{x}+y,z$ [$\bar{v},u-v,\bar{w}$]	(6) $x-y,x,z$ [$\bar{u}+v,\bar{u},\bar{w}$]
	(7) $\bar{y},\bar{x},z+1/2$ [v,u,\bar{w}]	(8) $\bar{x}+y,y,z+1/2$ [$u-v,\bar{v},\bar{w}$]	(9) $x,x-y,z+1/2$ [$\bar{u},\bar{u}+v,\bar{w}$]
	(10) $y,x,z+1/2$ [v,u,w]	(11) $x-y,\bar{y},z+1/2$ [$u-v,\bar{v},w$]	(12) $\bar{x},\bar{x}+y,z+1/2$ [$\bar{u},\bar{u}+v,w$]
	2 a 6'..	$0,0,z$ [$0,0,0$]	$0,0,z+1/2$ [$0,0,0$]

Symmetry of special projections

Along [001] $6'mm'$	Along [100] $\rho_{2a^*} 11m$ $a^* = c/2$	Along [210] $\rho 11m$ $a^* = c/2$
Origin at $0,0,z$	Origin at $x,0,0$	Origin at $x,x/2,0$

$\rho 6_3 mc$

6mm

Hexagonal

No. 70.1.352

$\rho 6_3 mc$

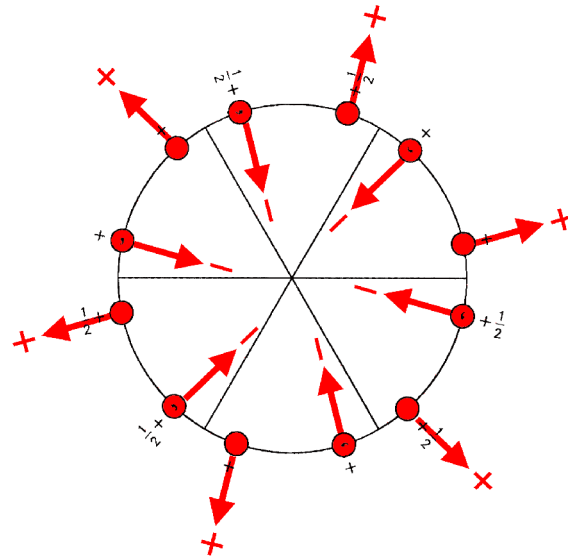
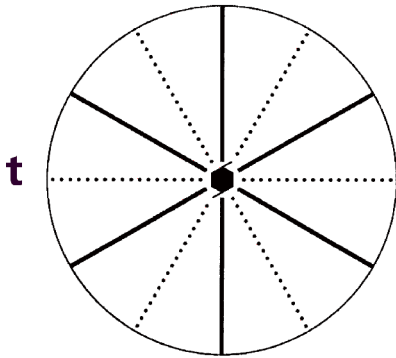

Origin on 3m1 on $6_3 mc$

Asymmetric unit $0 \leq x$; $0 \leq y$; $0 \leq z \leq 1$; $y \leq x/2$

Symmetry operations

- | | | |
|---|---|--|
| (1) 1
(1 0,0,0) | (2) 3^+ 0,0,z
(3_z 0,0,0) | (3) 3^- 0,0,z
(3_z^{-1} 0,0,0) |
| (4) 2 (0,0,1/2) 0,0,z
(2_z 0,0,1/2) | (5) 6^- (0,0,1/2) 0,0,z
(6_z^{-1} 0,0,1/2) | (6) 6^+ (0,0,1/2) 0,0,z
(6_z 0,0,1/2) |
| (7) m x, \bar{x}, z
(m_{xy} 0,0,0) | (8) m $x, 2x, z$
(m_x 0,0,0) | (9) m $2x, x, z$
(m_y 0,0,0) |
| (10) c (0,0,1/2) x, x, z
(m_3 0,0,1/2) | (11) c (0,0,1/2) $x, 0, z$
(m_2 0,0,1/2) | (12) c (0,0,1/2) 0,y,z
(m_1 0,0,1/2) |

Generators selected (1); $t(0,0,1)$; (2); (4); (7)

Positions

Multiplicity, Wyckoff letter, Site symmetry	Coordinates		
12 c 1	(1) $x,y,z [u,v,w]$	(2) $\bar{y},x-y,z [\bar{v},u-v,w]$	(3) $\bar{x}+y,\bar{x},z [\bar{u}+v,\bar{u},w]$
	(4) $\bar{x},\bar{y},z+1/2 [\bar{u},\bar{v},w]$	(5) $y,\bar{x}+y,z+1/2 [v,\bar{u}+v,w]$	(6) $x-y,x,z+1/2 [u-v,u,w]$
	(7) $\bar{y},\bar{x},z [v,u,\bar{w}]$	(8) $\bar{x}+y,y,z [u-v,\bar{v},\bar{w}]$	(9) $x,x-y,z [\bar{u},\bar{u}+v,\bar{w}]$
	(10) $y,x,z+1/2 [\bar{v},\bar{u},\bar{w}]$	(11) $x-y,\bar{y},z+1/2 [\bar{u}+v,v,\bar{w}]$	(12) $\bar{x},\bar{x}+y,z+1/2 [u,u-v,\bar{w}]$
6 b .m.	$x,\bar{x},z [u,u,0]$	$x,2x,z [\bar{u},0,0]$	$2\bar{x},\bar{x},z [0,\bar{u},0]$
	$\bar{x},x,z+1/2 [\bar{u},\bar{u},0]$	$\bar{x},2\bar{x},z+1/2 [u,0,0]$	$2x,x,z+1/2 [0,u,0]$
2 a 3m.	$0,0,z [0,0,0]$	$0,0,z+1/2 [0,0,0]$	

Symmetry of special projections

Along [001] $6mm$	Along [100] $\rho 11g1'$ $a^* = c$	Along [210] $\rho_{2a^*} 11m$ $a^* = c/2$
Origin at $0,0,z$	Origin at $x,0,0$	Origin at $x,x/2,0$

$p6_3mc1'$

$6mm1'$

Hexagonal

No. 70.2.353

$p6_3mc1'$

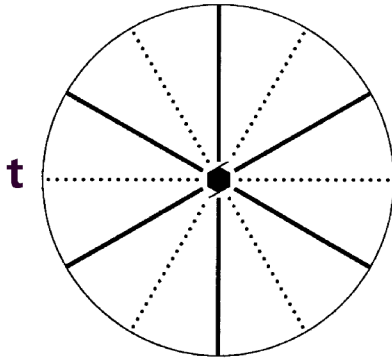

1'

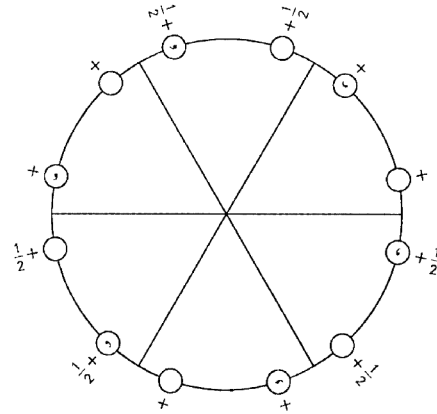

Origin on $3m11'$ on $6_3mc1'$

Asymmetric unit $0 \leq x; 0 \leq y; 0 \leq z \leq 1; y \leq x/2$

Symmetry operations

For 1 + set

- | | | |
|---|---|---|
| (1) 1
(1 0,0,0) | (2) 3^+ 0,0,z
(3_z 0,0,0) | (3) 3^- 0,0,z
(3_z^{-1} 0,0,0) |
| (4) 2 (0,0,1/2) 0,0,z
(2_z 0,0,1/2) | (5) 6^- (0,0,1/2) 0,0,z
(6_z^{-1} 0,0,1/2) | (6) 6^+ (0,0,1/2) 0,0,z
(6_z 0,0,1/2) |
| (7) m x, \bar{x}, z
(m_{xy} 0,0,0) | (8) m $x, 2x, z$
(m_x 0,0,0) | (9) m $2x, x, z$
(m_y 0,0,0) |
| (10) c (0,0,1/2) x, x, z
(m_3 0,0,1/2) | (11) c (0,0,1/2) $x, 0, z$
(m_2 0,0,1/2) | (12) c (0,0,1/2) $0, y, z$
(m_1 0,0,1/2) |

For 1' + set

- | | | |
|---|---|--|
| (1) 1'
(1 0,0,0)' | (2) $3^{+'}$ 0,0,z
(3_z 0,0,0)' | (3) $3^{-'}$ 0,0,z
(3_z^{-1} 0,0,0)' |
| (4) 2' (0,0,1/2) 0,0,z
(2_z 0,0,1/2)' | (5) $6^{-'}$ (0,0,1/2) 0,0,z
(6_z^{-1} 0,0,1/2)' | (6) $6^{+'}$ (0,0,1/2) 0,0,z
(6_z 0,0,1/2)' |
| (7) m' x, \bar{x}, z
(m_{xy} 0,0,0)' | (8) m' $x, 2x, z$
(m_x 0,0,0)' | (9) m' $2x, x, z$
(m_y 0,0,0)' |
| (10) c' (0,0,1/2) x, x, z
(m_3 0,0,1/2)' | (11) c' (0,0,1/2) $x, 0, z$
(m_2 0,0,1/2)' | (12) c' (0,0,1/2) $0, y, z$
(m_1 0,0,1/2)' |

Generators selected (1); $t(0,0,1)$; (2); (4); (7); $1'$

Positions

Multiplicity, Wyckoff letter, Site symmetry	Coordinates		
	$1+$	$1'+$	
12 c $11'$	(1) $x,y,z [0,0,0]$ (4) $\bar{x},\bar{y},z+1/2 [0,0,0]$ (7) $\bar{y},\bar{x},z [0,0,0]$ (10) $y,x,z+1/2 [0,0,0]$	(2) $\bar{y},x-y,z [0,0,0]$ (5) $y,\bar{x}+y,z+1/2 [0,0,0]$ (8) $\bar{x}+y,y,z [0,0,0]$ (11) $x-y,\bar{y},z+1/2 [0,0,0]$	(3) $\bar{x}+y,\bar{x},z [0,0,0]$ (6) $x-y,x,z+1/2 [0,0,0]$ (9) $x,x-y,z [0,0,0]$ (12) $\bar{x},\bar{x}+y,z+1/2 [0,0,0]$
6 b $.m.1'$	$x,\bar{x},z [0,0,0]$ $\bar{x},x,z+1/2 [0,0,0]$	$x,2x,z [0,0,0]$ $\bar{x},2\bar{x},z+1/2 [0,0,0]$	$2\bar{x},\bar{x},z [0,0,0]$ $2x,x,z+1/2 [0,0,0]$
2 a $3m.1'$	$0,0,z [0,0,0]$	$0,0,z+1/2 [0,0,0]$	

Symmetry of special projections

Along [001] $6mm1'$	Along [100] $\rho 11g1'$ $a^* = c$	Along [210] $\rho 11m1'$ $a^* = c/2$
Origin at $0,0,z$	Origin at $x,0,0$	Origin at $x,x/2,0$

$\rho 6_3 m' c'$

No. 70.3.354

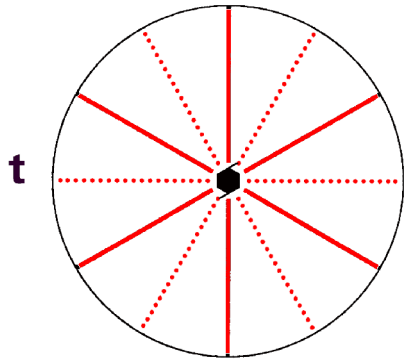

$6m'm'$

$\rho 6_3 m' c'$

Hexagonal

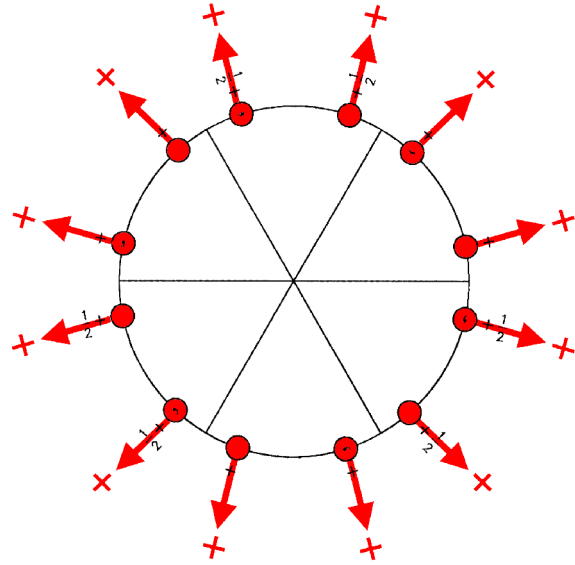

Origin on $3m'1$ on $6_3 m' c'$

Asymmetric unit $0 \leq x; 0 \leq y; 0 \leq z \leq 1; y \leq x/2$

Symmetry operations

- | | | |
|---|---|---|
| (1) 1
(1 0,0,0) | (2) 3^+ 0,0,z
(3_z 0,0,0) | (3) 3^- 0,0,z
(3_z^{-1} 0,0,0) |
| (4) 2 (0,0,1/2) 0,0,z
(2_z 0,0,1/2) | (5) 6^- (0,0,1/2) 0,0,z
(6_z^{-1} 0,0,1/2) | (6) 6^+ (0,0,1/2) 0,0,z
(6_z 0,0,1/2) |
| (7) m' x, \bar{x} ,z
(m_{xy} 0,0,0)' | (8) m' x,2x,z
(m_x 0,0,0)' | (9) m' 2x,x,z
(m_y 0,0,0)' |
| (10) c' (0,0,1/2) x,x,z
(m_3 0,0,1/2)' | (11) c' (0,0,1/2) x,0,z
(m_2 0,0,1/2)' | (12) c' (0,0,1/2) 0,y,z
(m_1 0,0,1/2)' |

Generators selected (1); $t(0,0,1)$; (2); (4); (7)

Positions

	Coordinates		
Multiplicity, Wyckoff letter, Site symmetry			
12 c 1	(1) $x,y,z [u,v,w]$	(2) $\bar{y},x-y,z [\bar{v},u-v,w]$	(3) $\bar{x}+y,\bar{x},z [\bar{u}+v,\bar{u},w]$
	(4) $\bar{x},\bar{y},z+1/2 [\bar{u},\bar{v},w]$	(5) $y,\bar{x}+y,z+1/2 [v,\bar{u}+v,w]$	(6) $x-y,x,z+1/2 [u-v,u,w]$
	(7) $\bar{y},\bar{x},z [\bar{v},\bar{u},w]$	(8) $\bar{x}+y,y,z [\bar{u}+v,v,w]$	(9) $x,x-y,z [u,u-v,w]$
	(10) $y,x,z+1/2 [v,u,w]$	(11) $x-y,\bar{y},z+1/2 [u-v,\bar{v},w]$	(12) $\bar{x},\bar{x}+y,z+1/2 [\bar{u},\bar{u}+v,w]$
6 b .m'	$x,\bar{x},z [u,\bar{u},w]$	$x,2x,z [u,2u,w]$	$2\bar{x},\bar{x},z [2\bar{u},\bar{u},w]$
	$\bar{x},x,z+1/2 [\bar{u},u,w]$	$\bar{x},2\bar{x},z+1/2 [\bar{u},2\bar{u},w]$	$2x,x,z+1/2 [2u,u,w]$
2 a 3m'	$0,0,z [0,0,w]$	$0,0,z+1/2 [0,0,w]$	

Symmetry of special projections

Along [001] $6m'm'$	Along [100] $\rho 11g'$	Along [210] $\rho 11m'$
Origin at 0,0,z	$a^* = c$ Origin at x,0,0	$a^* = c/2$ Origin at x,x/2,0

$\rho 6_3 'mc'$

No. 70.4.355

$6' mm'$

$\rho 6_3 'mc'$

Hexagonal

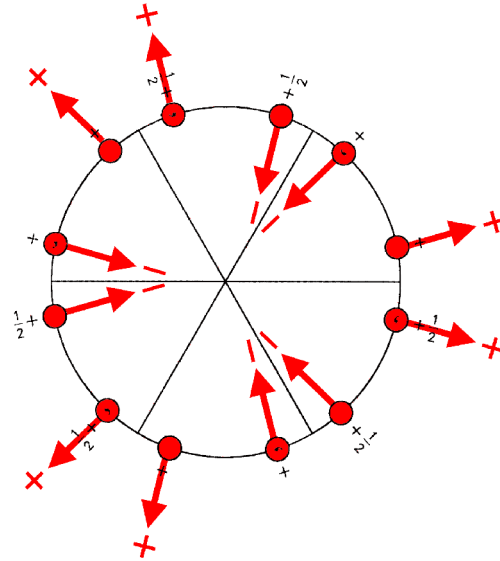
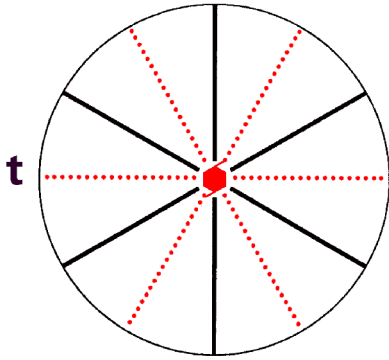

Origin on $3m1$ on $6_3 'mc'$

Asymmetric unit $0 \leq x; 0 \leq y; 0 \leq z \leq 1; y \leq x/2$

Symmetry operations

- | | | |
|---|--|---|
| (1) 1
(1 0,0,0) | (2) 3^+ 0,0,z
(3_z 0,0,0) | (3) 3^- 0,0,z
(3_z^{-1} 0,0,0) |
| (4) $2'$ (0,0,1/2) 0,0,z
(2_z 0,0,1/2)' | (5) 6^- (0,0,1/2) 0,0,z
(6_z^{-1} 0,0,1/2)' | (6) 6^+ (0,0,1/2) 0,0,z
(6_z 0,0,1/2)' |
| (7) m x, \bar{x}, z
(m_{xy} 0,0,0) | (8) m $x, 2x, z$
(m_x 0,0,0) | (9) m $2x, x, z$
(m_y 0,0,0) |
| (10) c' (0,0,1/2) x, x, z
(m_3 0,0,1/2)' | (11) c' (0,0,1/2) $x, 0, z$
(m_2 0,0,1/2)' | (12) c' (0,0,1/2) $0, y, z$
(m_1 0,0,1/2)' |

Generators selected (1); t(0,0,1); (2); (4); (7)

Positions

Multiplicity, Wyckoff letter, Site symmetry	Coordinates		
12 c 1	(1) x, y, z [u,v,w]	(2) $\bar{y}, x-y, z$ [\bar{v} ,u-v,w]	(3) $\bar{x}+y, \bar{x}, z$ [$\bar{u}+v, \bar{u}$,w]
	(4) $\bar{x}, \bar{y}, z+1/2$ [u,v, \bar{w}]	(5) $y, \bar{x}+y, z+1/2$ [\bar{v} ,u-v, \bar{w}]	(6) $x-y, x, z+1/2$ [$\bar{u}+v, \bar{u}$, \bar{w}]
	(7) \bar{y}, \bar{x}, z [v,u, \bar{w}]	(8) $\bar{x}+y, y, z$ [u-v, \bar{v} , \bar{w}]	(9) $x, x-y, z$ [$\bar{u}, \bar{u}+v, \bar{w}$]
	(10) $y, x, z+1/2$ [v,u,w]	(11) $x-y, \bar{y}, z+1/2$ [u-v, \bar{v} ,w]	(12) $\bar{x}, \bar{x}+y, z+1/2$ [$\bar{u}, \bar{u}+v, w$]
6 b .m.	x, \bar{x}, z [u,u,0]	$x, 2x, z$ [\bar{u} ,0,0]	$2\bar{x}, \bar{x}, z$ [0, \bar{u} ,0]
	$\bar{x}, x, z+1/2$ [u,u,0]	$\bar{x}, 2\bar{x}, z+1/2$ [\bar{u} ,0,0]	$2x, x, z+1/2$ [0, \bar{u} ,0]
2 a 3m.	$0, 0, z$ [0,0,0]	$0, 0, z+1/2$ [0,0,0]	

Symmetry of special projections

Along [001] $6'mm'$	Along [100] $\rho 11g1'$	Along [210] $\rho 11m$
Origin at 0,0,z	$a^* = c$ Origin at x,0,0	$a^* = c/2$ Origin at x,x/2,0

$p6_3'm'c$

No. 70.5.356

$6'm'm$

$p6_3'm'c$

Hexagonal

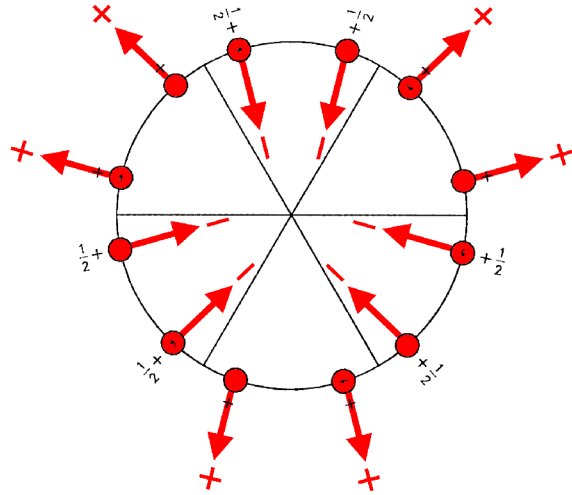
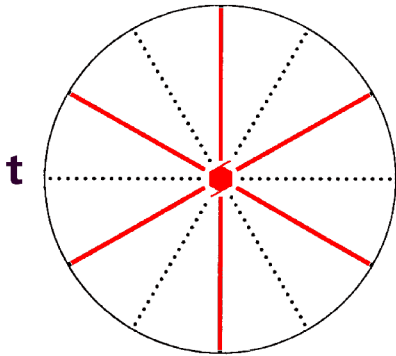

Origin on $3m'1$ on $6_3'm'c$

Asymmetric unit $0 \leq x; 0 \leq y; 0 \leq z \leq 1; y \leq x/2$

Symmetry operations

- | | | |
|---|--|---|
| (1) 1
(1 0,0,0) | (2) 3^+ 0,0,z
(3_z 0,0,0) | (3) 3^- 0,0,z
(3_z^{-1} 0,0,0) |
| (4) $2'$ (0,0,1/2) 0,0,z
(2_z 0,0,1/2)' | (5) 6^- (0,0,1/2) 0,0,z
(6_z^{-1} 0,0,1/2)' | (6) 6^+ (0,0,1/2) 0,0,z
(6_z 0,0,1/2)' |
| (7) m' x, \bar{x} ,z
(m_{xy} 0,0,0)' | (8) m' x,2x,z
(m_x 0,0,0)' | (9) m' 2x,x,z
(m_y 0,0,0)' |
| (10) c (0,0,1/2) x,x,z
(m_3 0,0,1/2) | (11) c (0,0,1/2) x,0,z
(m_2 0,0,1/2) | (12) c (0,0,1/2) 0,y,z
(m_1 0,0,1/2) |

Generators selected (1); $t(0,0,1)$; (2); (4); (7)

Positions

	Coordinates		
Multiplicity, Wyckoff letter, Site symmetry			
12 c 1	(1) $x,y,z [u,v,w]$	(2) $\bar{y},x-y,z [\bar{v},u-v,w]$	(3) $\bar{x}+y,\bar{x},z [\bar{u}+v,\bar{u},w]$
	(4) $\bar{x},\bar{y},z+1/2 [u,v,\bar{w}]$	(5) $y,\bar{x}+y,z+1/2 [\bar{v},u-v,\bar{w}]$	(6) $x-y,x,z+1/2 [\bar{u}+v,\bar{u},\bar{w}]$
	(7) $\bar{y},\bar{x},z [\bar{v},\bar{u},w]$	(8) $\bar{x}+y,y,z [\bar{u}+v,v,w]$	(9) $x,x-y,z [u,u-v,w]$
	(10) $y,x,z+1/2 [\bar{v},\bar{u},\bar{w}]$	(11) $x-y,\bar{y},z+1/2 [\bar{u}+v,v,\bar{w}]$	(12) $\bar{x},\bar{x}+y,z+1/2 [u,u-v,\bar{w}]$
6 b .m'	$x,\bar{x},z [u,\bar{u},w]$	$x,2x,z [u,2u,w]$	$2\bar{x},\bar{x},z [2\bar{u},\bar{u},w]$
	$\bar{x},x,z+1/2 [u,\bar{u},\bar{w}]$	$\bar{x},2\bar{x},z+1/2 [u,2u,\bar{w}]$	$2x,x,z+1/2 [2\bar{u},\bar{u},\bar{w}]$
2 a 3m'	$0,0,z [0,0,w]$	$0,0,z+1/2 [0,0,\bar{w}]$	

Symmetry of special projections

Along [001] $6'm'm$	Along [100] $\rho 11g$	Along [210] $\rho_{2a^*} 11m'$
Origin at 0,0,z	$a^* = c$ Origin at $x,0,0$	$a^* = c/2$ Origin at $x,x/2,0$

$\rho\bar{6}m2$

No. 71.1.357

$\bar{6}m2$

$\rho\bar{6}m2$

Hexagonal

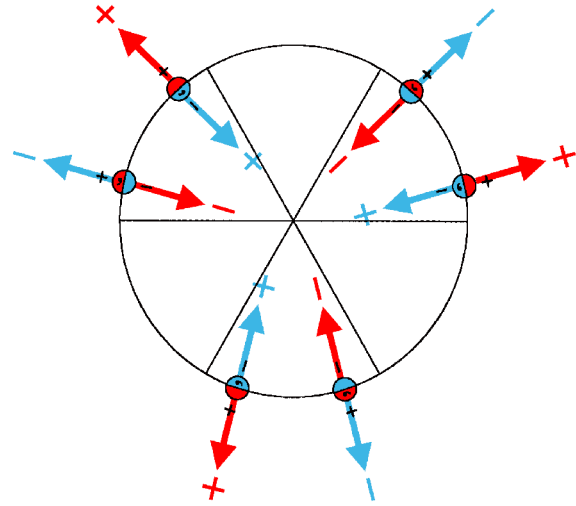
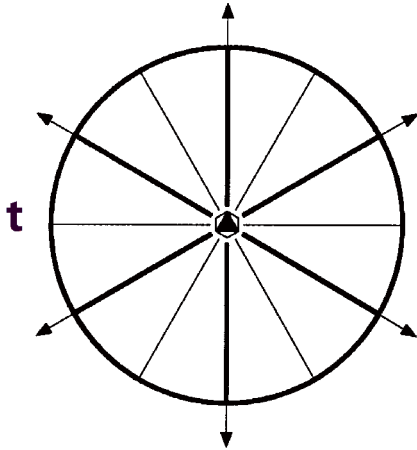

Origin on $\bar{6}m2$

Asymmetric unit $y \leq x/2; y \geq -x; 0 \leq z \leq 1/2$

Symmetry operations

- | | | |
|---|--|---|
| (1) 1
(1 0,0,0) | (2) 3^+ 0,0,z
(3_z 0,0,0) | (3) 3^- 0,0,z
(3_z^{-1} 0,0,0) |
| (4) m x,y,0
(m_z 0,0,0) | (5) $\bar{6}^-$ 0,0,z; 0,0,0
($\bar{6}_z^{-1}$ 0,0,0) | (6) $\bar{6}^+$ 0,0,z; 0,0,0
($\bar{6}_z$ 0,0,0) |
| (7) m x, \bar{x} ,z
(m_{xy} 0,0,0) | (8) m x,2x,z
(m_x 0,0,0) | (9) m 2x,x,z
(m_y 0,0,0) |
| (10) 2 x, \bar{x} ,0
(2_3 0,0,0) | (11) 2 x,2x,0
(2_2 0,0,0) | (12) 2 2x,x,0
(2_1 0,0,0) |

Generators selected (1); $t(0,0,1)$; (2); (4); (7)

Positions

	Coordinates		
Multiplicity, Wyckoff letter, Site symmetry			
12 i 1	(1) x,y,z [u,v,w]	(2) $\bar{y},x-y,z$ [$\bar{v},u-v,w$]	(3) $\bar{x}+y,\bar{x},z$ [$\bar{u}+v,\bar{u},w$]
	(4) x,y,\bar{z} [\bar{u},\bar{v},w]	(5) $\bar{y},x-y,\bar{z}$ [$v,\bar{u}+v,w$]	(6) $\bar{x}+y,\bar{x},\bar{z}$ [$u-v,u,w$]
	(7) \bar{y},\bar{x},z [v,u,\bar{w}]	(8) $\bar{x}+y,y,z$ [$u-v,\bar{v},\bar{w}$]	(9) $x,x-y,z$ [$\bar{u},\bar{u}+v,\bar{w}$]
	(10) \bar{y},\bar{x},\bar{z} [\bar{v},\bar{u},\bar{w}]	(11) $\bar{x}+y,y,\bar{z}$ [$\bar{u}+v,v,\bar{w}$]	(12) $x,x-y,\bar{z}$ [$u,u-v,\bar{w}$]
6 h .m.	x,\bar{x},z [$u,u,0$]	$x,2x,z$ [$\bar{u},0,0$]	$2\bar{x},\bar{x},z$ [$0,\bar{u},0$]
	x,\bar{x},\bar{z} [$\bar{u},\bar{u},0$]	$x,2x,\bar{z}$ [$u,0,0$]	$2\bar{x},\bar{x},\bar{z}$ [$0,u,0$]
6 g m..	$x,y,1/2$ [$0,0,w$]	$\bar{y},x-y,1/2$ [$0,0,w$]	$\bar{x}+y,\bar{x},1/2$ [$0,0,w$]
	$\bar{y},\bar{x},1/2$ [$0,0,\bar{w}$]	$\bar{x}+y,y,1/2$ [$0,0,\bar{w}$]	$x,x-y,1/2$ [$0,0,\bar{w}$]
6 f m..	$x,y,0$ [$0,0,w$]	$\bar{y},x-y,0$ [$0,0,w$]	$\bar{x}+y,\bar{x},0$ [$0,0,w$]
	$\bar{y},\bar{x},0$ [$0,0,\bar{w}$]	$\bar{x}+y,y,0$ [$0,0,\bar{w}$]	$x,x-y,0$ [$0,0,\bar{w}$]
3 e mm2	$x,\bar{x},1/2$ [$0,0,0$]	$x,2x,1/2$ [$0,0,0$]	$2\bar{x},\bar{x},1/2$ [$0,0,0$]
3 d mm2	$x,\bar{x},0$ [$0,0,0$]	$x,2x,0$ [$0,0,0$]	$2\bar{x},\bar{x},0$ [$0,0,0$]
2 c 3m.	$0,0,z$ [$0,0,0$]	$0,0,\bar{z}$ [$0,0,0$]	
1 b $\bar{6}m2$	$0,0,1/2$ [$0,0,0$]		
1 a $\bar{6}m2$	$0,0,0$ [$0,0,0$]		

Continued

No. 71.1.357

$\bar{p}6m2$

Symmetry of special projections

Along [001] $3m1'$

Origin at 0,0,z

Along [100] $p1m11'$

$a^* = c$

Origin at x,0,0

Along [210] $p2mm$

$a^* = c$

Origin at x,x/2,0

$\overline{p6}m21'$

$\overline{6}m21'$

Hexagonal

No. 71.2.358

$\overline{p6}m21'$

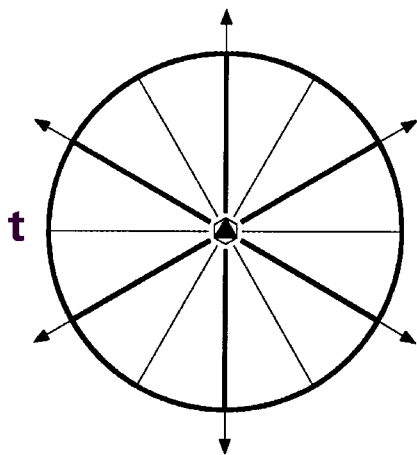

1'

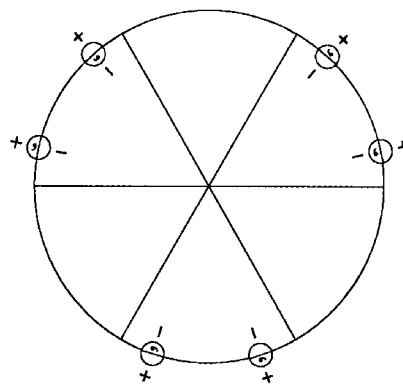

Origin on $\overline{6}m21'$

Asymmetric unit $y \leq x/2; y \geq -x; 0 \leq z \leq 1/2$

Symmetry operations

For 1 + set

- | | | |
|---|--|---|
| (1) 1
(1 0,0,0) | (2) 3^+ 0,0,z
(3_z 0,0,0) | (3) 3^- 0,0,z
(3_z^{-1} 0,0,0) |
| (4) m x,y,0
(m_z 0,0,0) | (5) $\overline{6}^-$ 0,0,z; 0,0,0
($\overline{6}_z^{-1}$ 0,0,0) | (6) $\overline{6}^+$ 0,0,z; 0,0,0
($\overline{6}_z$ 0,0,0) |
| (7) m x, \bar{x} ,z
(m_{xy} 0,0,0) | (8) m x,2x,z
(m_x 0,0,0) | (9) m 2x,x,z
(m_y 0,0,0) |
| (10) 2 x, \bar{x} ,0
(2_3 0,0,0) | (11) 2 x,2x,0
(2_2 0,0,0) | (12) 2 2x,x,0
(2_1 0,0,0) |

For 1' + set

- | | | |
|---|--|---|
| (1) 1'
(1 0,0,0)' | (2) $3^{+'}$ 0,0,z
(3_z 0,0,0)' | (3) $3^{-'}$ 0,0,z
(3_z^{-1} 0,0,0)' |
| (4) m' x,y,0
(m_z 0,0,0)' | (5) $\overline{6}^{-'}$ 0,0,z; 0,0,0
($\overline{6}_z^{-1}$ 0,0,0)' | (6) $\overline{6}^{+'}$ 0,0,z; 0,0,0
($\overline{6}_z$ 0,0,0)' |
| (7) m' x, \bar{x} ,z
(m_{xy} 0,0,0)' | (8) m' x,2x,z
(m_x 0,0,0)' | (9) m' 2x,x,z
(m_y 0,0,0)' |
| (10) 2' x, \bar{x} ,0
(2_3 0,0,0)' | (11) 2' x,2x,0
(2_2 0,0,0)' | (12) 2' 2x,x,0
(2_1 0,0,0)' |

Generators selected (1); $t(0,0,1)$; (2); (4); (7); $1'$

Positions

Multiplicity, Wyckoff letter, Site symmetry	Coordinates		
		$1+$	$1'+$
12 i $11'$	(1) x,y,z [0,0,0]	(2) $\bar{y},x-y,z$ [0,0,0]	(3) $\bar{x}+y,\bar{x},z$ [0,0,0]
	(4) x,y,\bar{z} [0,0,0]	(5) $\bar{y},x-y,\bar{z}$ [0,0,0]	(6) $\bar{x}+y,\bar{x},\bar{z}$ [0,0,0]
	(7) \bar{y},\bar{x},z [0,0,0]	(8) $\bar{x}+y,y,z$ [0,0,0]	(9) $x,x-y,z$ [0,0,0]
	(10) \bar{y},\bar{x},\bar{z} [0,0,0]	(11) $\bar{x}+y,y,\bar{z}$ [0,0,0]	(12) $x,x-y,\bar{z}$ [0,0,0]
6 h $.m.1'$	x,\bar{x},z [0,0,0]	$x,2x,z$ [0,0,0]	$2\bar{x},\bar{x},z$ [0,0,0]
	x,\bar{x},\bar{z} [0,0,0]	$x,2x,\bar{z}$ [0,0,0]	$2\bar{x},\bar{x},\bar{z}$ [0,0,0]
6 g $m..1'$	$x,y,1/2$ [0,0,0]	$\bar{y},x-y,1/2$ [0,0,0]	$\bar{x}+y,\bar{x},1/2$ [0,0,0]
	$\bar{y},\bar{x},1/2$ [0,0,0]	$\bar{x}+y,y,1/2$ [0,0,0]	$x,x-y,1/2$ [0,0,0]
6 f $m..1'$	$x,y,0$ [0,0,0]	$\bar{y},x-y,0$ [0,0,0]	$\bar{x}+y,\bar{x},0$ [0,0,0]
	$\bar{y},\bar{x},0$ [0,0,0]	$\bar{x}+y,y,0$ [0,0,0]	$x,x-y,0$ [0,0,0]
3 e $mm21'$	$x,\bar{x},1/2$ [0,0,0]	$x,2x,1/2$ [0,0,0]	$2\bar{x},\bar{x},1/2$ [0,0,0]
3 d $mm21'$	$x,\bar{x},0$ [0,0,0]	$x,2x,0$ [0,0,0]	$2\bar{x},\bar{x},0$ [0,0,0]
2 c $3m.1'$	$0,0,z$ [0,0,0]	$0,0,\bar{z}$ [0,0,0]	
1 b $\overline{6m}21'$	$0,0,1/2$ [0,0,0]		
1 a $\overline{6m}21'$	$0,0,0$ [0,0,0]		

Continued

No. 71.2.358

$\bar{p}6m21'$

Symmetry of special projections

Along [001] $3m1'$

Origin at 0,0,z

Along [100] $p1m11'$

$a^* = c$

Origin at x,0,0

Along [210] $p2mm1'$

$a^* = c$

Origin at x,x/2,0

$\rho\bar{6}m'2'$

No. 71.3.359

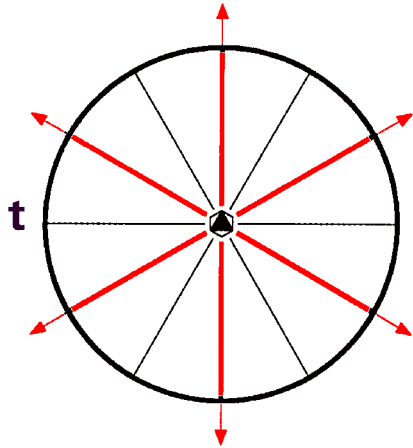

$\bar{6}m'2'$

$\rho\bar{6}m'2'$

Hexagonal

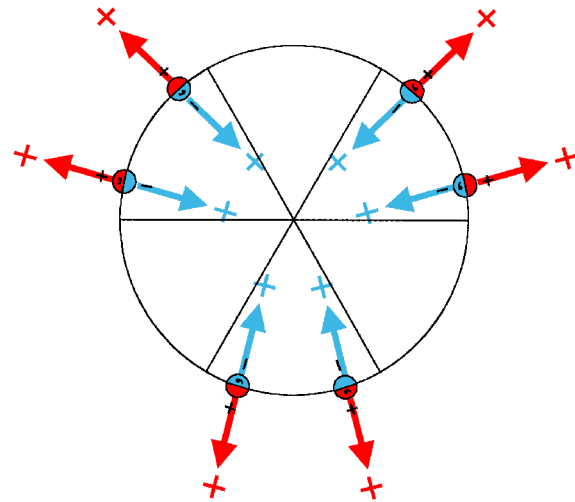

Origin on $\bar{6}m'2'$

Asymmetric unit $y \leq x/2; y \geq -x; 0 \leq z \leq 1/2$

Symmetry operations

- | | | |
|---|--|---|
| (1) 1
(1 0,0,0) | (2) 3^+ 0,0,z
(3_z 0,0,0) | (3) 3^- 0,0,z
(3_z^{-1} 0,0,0) |
| (4) m x,y,0
(m_z 0,0,0) | (5) $\bar{6}^-$ 0,0,z; 0,0,0
($\bar{6}_z^{-1}$ 0,0,0) | (6) $\bar{6}^+$ 0,0,z; 0,0,0
($\bar{6}_z$ 0,0,0) |
| (7) m' x, \bar{x} ,z
(m_{xy} 0,0,0)' | (8) m' x,2x,z
(m_x 0,0,0)' | (9) m' 2x,x,z
(m_y 0,0,0)' |
| (10) $2'$ x, \bar{x} ,0
(2_3 0,0,0)' | (11) $2'$ x,2x,0
(2_2 0,0,0)' | (12) $2'$ 2x,x,0
(2_1 0,0,0)' |

Generators selected (1); $t(0,0,1)$; (2); (4); (7)

Positions

	Coordinates		
Multiplicity, Wyckoff letter, Site symmetry			
12 i 1	(1) x,y,z [u,v,w]	(2) $\bar{y},x-y,z$ [$\bar{v},u-v,w$]	(3) $\bar{x}+y,\bar{x},z$ [$\bar{u}+v,\bar{u},w$]
	(4) x,y,\bar{z} [\bar{u},\bar{v},w]	(5) $\bar{y},x-y,\bar{z}$ [$v,\bar{u}+v,w$]	(6) $\bar{x}+y,\bar{x},\bar{z}$ [u-v,u,w]
	(7) \bar{y},\bar{x},z [\bar{v},\bar{u},w]	(8) $\bar{x}+y,y,z$ [$\bar{u}+v,v,w$]	(9) $x,x-y,z$ [u,u-v,w]
	(10) \bar{y},\bar{x},\bar{z} [v,u,w]	(11) $\bar{x}+y,y,\bar{z}$ [u-v, \bar{v},w]	(12) $x,x-y,\bar{z}$ [$\bar{u},\bar{u}+v,w$]
6 h .m'	x,\bar{x},z [u, \bar{u},w]	$x,2x,z$ [u,2u,w]	$2\bar{x},\bar{x},z$ [2 \bar{u},\bar{u},w]
	x,\bar{x},\bar{z} [\bar{u},u,w]	$x,2x,\bar{z}$ [$\bar{u},2\bar{u},w$]	$2\bar{x},\bar{x},\bar{z}$ [2u,u,w]
6 g m..	$x,y,1/2$ [0,0,w]	$\bar{y},x-y,1/2$ [0,0,w]	$\bar{x}+y,\bar{x},1/2$ [0,0,w]
	$\bar{y},\bar{x},1/2$ [0,0,w]	$\bar{x}+y,y,1/2$ [0,0,w]	$x,x-y,1/2$ [0,0,w]
6 f m..	$x,y,0$ [0,0,w]	$\bar{y},x-y,0$ [0,0,w]	$\bar{x}+y,\bar{x},0$ [0,0,w]
	$\bar{y},\bar{x},0$ [0,0,w]	$\bar{x}+y,y,0$ [0,0,w]	$x,x-y,0$ [0,0,w]
3 e mm'2'	$x,\bar{x},1/2$ [0,0,w]	$x,2x,1/2$ [0,0,w]	$2\bar{x},\bar{x},1/2$ [0,0,w]
3 d mm'2'	$x,\bar{x},0$ [0,0,w]	$x,2x,0$ [0,0,w]	$2\bar{x},\bar{x},0$ [0,0,w]
2 c 3m'	$0,0,z$ [0,0,w]	$0,0,\bar{z}$ [0,0,w]	
1 b $\bar{6}m'2'$	$0,0,1/2$ [0,0,w]		
1 a $\bar{6}m'2'$	$0,0,0$ [0,0,w]		

Continued

No. 71.3.359

$\bar{p}6m'2'$

Symmetry of special projections

Along [001] $3m'1'$

Origin at 0,0,z

Along [100] $p1m1$

$a^* = c$

Origin at x,0,0

Along [210] $p2'mm'$

$a^* = c$

Origin at x,x/2,0

$\bar{p}\bar{6}'m2'$

No. 71.4.360

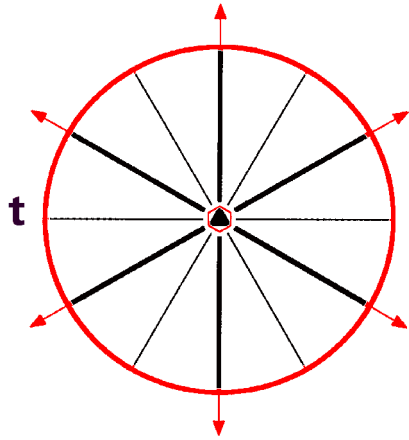

$\bar{6}'m2'$

$\bar{p}\bar{6}'m2'$

Hexagonal

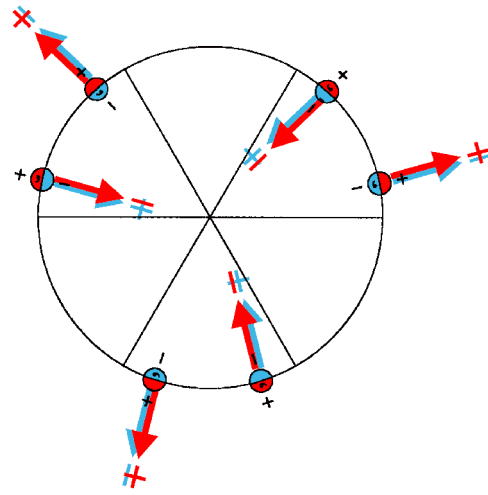

Origin on $\bar{6}'m2'$

Asymmetric unit $y \leq x/2; y \geq -x; 0 \leq z \leq 1/2$

Symmetry operations

- | | | |
|---|--|---|
| (1) 1
(1 0,0,0) | (2) 3^+ 0,0,z
(3_z 0,0,0) | (3) 3^- 0,0,z
(3_z^{-1} 0,0,0) |
| (4) m' x,y,0
(m_z 0,0,0)' | (5) $\bar{6}^-'$ 0,0,z; 0,0,0
($\bar{6}_z^{-1}$ 0,0,0)' | (6) $\bar{6}^+'$ 0,0,z; 0,0,0
($\bar{6}_z$ 0,0,0)' |
| (7) m x, \bar{x} ,z
(m_{xy} 0,0,0) | (8) m x,2x,z
(m_x 0,0,0) | (9) m 2x,x,z
(m_y 0,0,0) |
| (10) $2'$ x, \bar{x} ,0
(2_3 0,0,0)' | (11) $2'$ x,2x,0
(2_2 0,0,0)' | (12) $2'$ 2x,x,0
(2_1 0,0,0)' |

Generators selected (1); t(0,0,1); (2); (4); (7)

Positions

	Coordinates		
Multiplicity, Wyckoff letter, Site symmetry			
12 i 1	(1) x,y,z [u,v,w]	(2) $\bar{y},x-y,z$ [$\bar{v},u-v,w$]	(3) $\bar{x}+y,\bar{x},z$ [$\bar{u}+v,\bar{u},w$]
	(4) x,y, \bar{z} [u,v, \bar{w}]	(5) $\bar{y},x-y,\bar{z}$ [$\bar{v},u-v,\bar{w}$]	(6) $\bar{x}+y,\bar{x},\bar{z}$ [$\bar{u}+v,\bar{u},\bar{w}$]
	(7) \bar{y},\bar{x},z [v,u, \bar{w}]	(8) $\bar{x}+y,y,z$ [u-v, \bar{v},\bar{w}]	(9) x,x-y,z [$\bar{u},\bar{u}+v,\bar{w}$]
	(10) \bar{y},\bar{x},\bar{z} [v,u,w]	(11) $\bar{x}+y,y,\bar{z}$ [u-v, \bar{v},w]	(12) x,x-y, \bar{z} [$\bar{u},\bar{u}+v,w$]
6 h .m.	x, \bar{x},z [u,u,0]	x,2x,z [$\bar{u},0,0$]	2 \bar{x},\bar{x},z [0, $\bar{u},0$]
	x, \bar{x},\bar{z} [u,u,0]	x,2x, \bar{z} [$\bar{u},0,0$]	2 \bar{x},\bar{x},\bar{z} [0, $\bar{u},0$]
6 g m'..	x,y,1/2 [u,v,0]	$\bar{y},x-y,1/2$ [$\bar{v},u-v,0$]	$\bar{x}+y,\bar{x},1/2$ [$\bar{u}+v,\bar{u},0$]
	$\bar{y},\bar{x},1/2$ [v,u,0]	$\bar{x}+y,y,1/2$ [u-v, $\bar{v},0$]	x,x-y,1/2 [$\bar{u},\bar{u}+v,0$]
6 f m'..	x,y,0 [u,v,0]	$\bar{y},x-y,0$ [$\bar{v},u-v,0$]	$\bar{x}+y,\bar{x},0$ [$\bar{u}+v,\bar{u},0$]
	$\bar{y},\bar{x},0$ [v,u,0]	$\bar{x}+y,y,0$ [u-v, $\bar{v},0$]	x,x-y,0 [$\bar{u},\bar{u}+v,0$]
3 e m'm2'	x, $\bar{x},1/2$ [u,u,0]	x,2x,1/2 [$\bar{u},0,0$]	2 $\bar{x},\bar{x},1/2$ [0, $\bar{u},0$]
3 d m'm2'	x, $\bar{x},0$ [u,u,0]	x,2x,0 [$\bar{u},0,0$]	2 $\bar{x},\bar{x},0$ [0, $\bar{u},0$]
2 c 3m.	0,0,z [0,0,0]	0,0, \bar{z} [0,0,0]	
1 b $\bar{6}'m2'$	0,0,1/2 [0,0,0]		
1 a $\bar{6}'m2'$	0,0,0 [0,0,0]		

Continued

No. 71.4.360

$\bar{p}6'm2'$

Symmetry of special projections

Along [001] $3m$

Origin at 0,0,z

Along [100] $p1m1'$

$a^* = c$

Origin at x,0,0

Along [210] $p2'm'm$

$a^* = c$

Origin at x,x/2,0

$\rho\bar{6}'m'2'$

No. 71.5.361

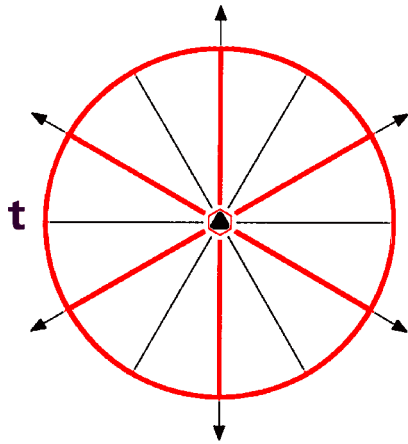

$\bar{6}'m'2'$

$\rho\bar{6}'m'2'$

Hexagonal

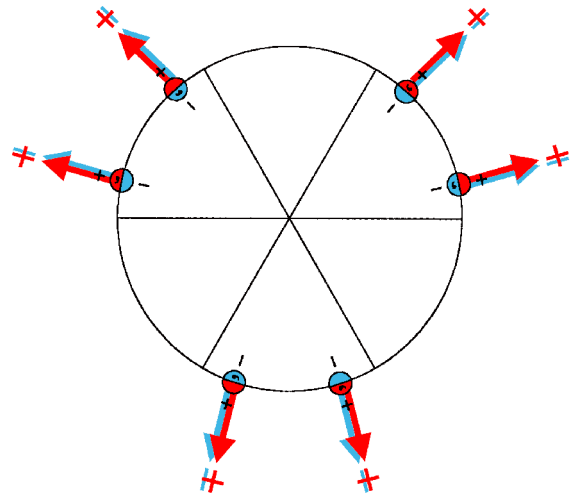

Origin on $\bar{6}'m'2'$

Asymmetric unit $y \leq x/2; y \geq -x; 0 \leq z \leq 1/2$

Symmetry operations

- | | | |
|---|--|--|
| (1) 1
(1 0,0,0) | (2) 3^+ 0,0,z
(3_z 0,0,0) | (3) 3^- 0,0,z
(3_z^{-1} 0,0,0) |
| (4) m' x,y,0
(m_z 0,0,0)' | (5) $\bar{6}'$ 0,0,z; 0,0,0
($\bar{6}_z^{-1}$ 0,0,0)' | (6) $\bar{6}^+$ 0,0,z; 0,0,0
($\bar{6}_z$ 0,0,0)' |
| (7) m' x, \bar{x} ,z
(m_{xy} 0,0,0)' | (8) m' x,2x,z
(m_x 0,0,0)' | (9) m' 2x,x,z
(m_y 0,0,0)' |
| (10) 2 x, \bar{x} ,0
(2_3 0,0,0) | (11) 2 x,2x,0
(2_2 0,0,0) | (12) 2 2x,x,0
(2_1 0,0,0) |

Generators selected (1); $t(0,0,1)$; (2); (4); (7)

Positions

	Coordinates		
Multiplicity, Wyckoff letter, Site symmetry			
12 i 1	(1) x,y,z $[u,v,w]$	(2) $\bar{y},x-y,z$ $[\bar{v},u-v,w]$	(3) $\bar{x}+y,\bar{x},z$ $[\bar{u}+v,\bar{u},w]$
	(4) x,y,\bar{z} $[u,v,\bar{w}]$	(5) $\bar{y},x-y,\bar{z}$ $[\bar{v},u-v,\bar{w}]$	(6) $\bar{x}+y,\bar{x},\bar{z}$ $[\bar{u}+v,\bar{u},\bar{w}]$
	(7) \bar{y},\bar{x},z $[\bar{v},\bar{u},w]$	(8) $\bar{x}+y,y,z$ $[\bar{u}+v,v,w]$	(9) $x,x-y,z$ $[u,u-v,w]$
	(10) \bar{y},\bar{x},\bar{z} $[\bar{v},\bar{u},\bar{w}]$	(11) $\bar{x}+y,y,\bar{z}$ $[\bar{u}+v,v,\bar{w}]$	(12) $x,x-y,\bar{z}$ $[u,u-v,\bar{w}]$
6 h .m'	x,\bar{x},z $[u,\bar{u},w]$	$x,2x,z$ $[u,2u,w]$	$2\bar{x},\bar{x},z$ $[2\bar{u},\bar{u},w]$
	x,\bar{x},\bar{z} $[u,\bar{u},\bar{w}]$	$x,2x,\bar{z}$ $[u,2u,\bar{w}]$	$2\bar{x},\bar{x},\bar{z}$ $[2\bar{u},\bar{u},\bar{w}]$
6 g m'..	$x,y,1/2$ $[u,v,0]$	$\bar{y},x-y,1/2$ $[\bar{v},u-v,0]$	$\bar{x}+y,\bar{x},1/2$ $[\bar{u}+v,\bar{u},0]$
	$\bar{y},\bar{x},1/2$ $[\bar{v},\bar{u},0]$	$\bar{x}+y,y,1/2$ $[\bar{u}+v,v,0]$	$x,x-y,1/2$ $[u,u-v,0]$
6 f m'..	$x,y,0$ $[u,v,0]$	$\bar{y},x-y,0$ $[\bar{v},u-v,0]$	$\bar{x}+y,\bar{x},0$ $[\bar{u}+v,\bar{u},0]$
	$\bar{y},\bar{x},0$ $[\bar{v},\bar{u},0]$	$\bar{x}+y,y,0$ $[\bar{u}+v,v,0]$	$x,x-y,0$ $[u,u-v,0]$
3 e m'm'2	$x,\bar{x},1/2$ $[u,\bar{u},0]$	$x,2x,1/2$ $[u,2u,0]$	$2\bar{x},\bar{x},1/2$ $[2\bar{u},\bar{u},0]$
3 d m'm'2	$x,\bar{x},0$ $[u,\bar{u},0]$	$x,2x,0$ $[u,2u,0]$	$2\bar{x},\bar{x},0$ $[2\bar{u},\bar{u},0]$
2 c 3m'	$0,0,z$ $[0,0,w]$	$0,0,\bar{z}$ $[0,0,\bar{w}]$	
1 b $\bar{6}'m'2$	$0,0,1/2$ $[0,0,0]$		
1 a $\bar{6}'m'2$	$0,0,0$ $[0,0,0]$		

Continued

No. 71.5.361

$\bar{p}6'm'2$

Symmetry of special projections

Along [001] $3m'$

Origin at 0,0,z

Along [100] $p1m'1$

$a^* = c$

Origin at x,0,0

Along [210] $p2m'm'$

$a^* = c$

Origin at x,x/2,0

$\rho_{2c}\bar{6}m'2'$

No. 71.6.362

 $\bar{6}m21'$ $\rho_{2c}\bar{6}m'2'$

Hexagonal

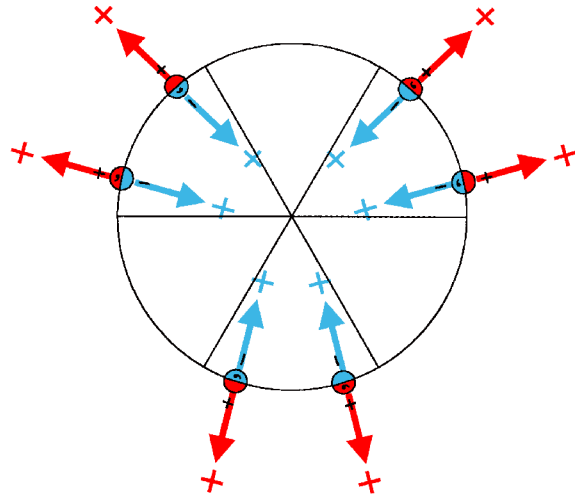
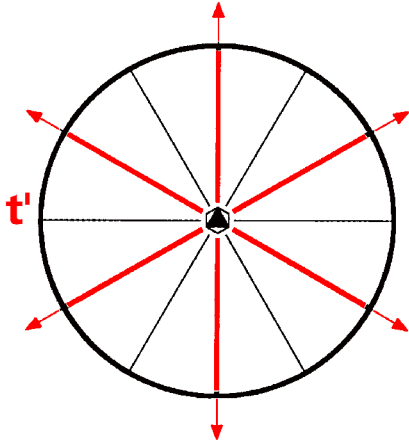
Origin on $\bar{6}m'2'$ Asymmetric unit $y \leq x/2$; $y \geq -x$; $0 \leq z \leq 1/2$

Symmetry operations

For (0,0,0) + set

- | | | |
|---|--|---|
| (1) 1
(1 0,0,0) | (2) 3^+ 0,0,z
(3_z 0,0,0) | (3) 3^- 0,0,z
(3_z^{-1} 0,0,0) |
| (4) m x,y,0
(m_z 0,0,0) | (5) $\bar{6}^-$ 0,0,z; 0,0,0
($\bar{6}_z^{-1}$ 0,0,0) | (6) $\bar{6}^+$ 0,0,z; 0,0,0
($\bar{6}_z$ 0,0,0) |
| (7) m' x, \bar{x} ,z
(m_{xy} 0,0,0)' | (8) m' x,2x,z
(m_x 0,0,0)' | (9) m' 2x,x,z
(m_y 0,0,0)' |
| (10) 2' x, \bar{x} ,0
(2_3 0,0,0)' | (11) 2' x,2x,0
(2_2 0,0,0)' | (12) 2' 2x,x,0
(2_1 0,0,0)' |

For (0,0,1)' + set

- | | | |
|---|--|---|
| (1) t' (0,0,1)
(1 0,0,0)' | (2) $3^{+'}$ (0,0,1) 0,0,z
(3_z 0,0,1)' | (3) $3^{-'}$ (0,0,1) 0,0,z
(3_z^{-1} 0,0,1)' |
| (4) m' x,y,1/2
(m_z 0,0,1)' | (5) $\bar{6}^{-'}$ 0,0,z; 0,0,1/2
($\bar{6}_z^{-1}$ 0,0,1)' | (6) $\bar{6}^{+'}$ 0,0,z; 0,0,1/2
($\bar{6}_z$ 0,0,1)' |
| (7) c (0,0,1) x, \bar{x} ,z
(m_{xy} 0,0,1) | (8) c (0,0,1) x,2x,z
(m_x 0,0,1) | (9) c (0,0,1) 2x,x,z
(m_y 0,0,1) |
| (10) 2 x, \bar{x} ,1/2
(2_3 0,0,1) | (11) 2 x,2x,1/2
(2_2 0,0,1) | (12) 2 2x,x,1/2
(2_1 0,0,1) |

Generators selected (1); $t(0,0,1)'$; (2); (4); (7)

Positions

Multiplicity, Wyckoff letter, Site symmetry	Coordinates		
		(0,0,0)+	(0,0,1)' +
12 i 1	(1) $x,y,z [u,v,w]$	(2) $\bar{y},x-y,z [\bar{v},u-v,w]$	(3) $\bar{x}+y,\bar{x},z [\bar{u}+v,\bar{u},w]$
	(4) $x,y,\bar{z} [\bar{u},\bar{v},w]$	(5) $\bar{y},x-y,\bar{z} [v,\bar{u}+v,w]$	(6) $\bar{x}+y,\bar{x},\bar{z} [u-v,u,w]$
	(7) $\bar{y},\bar{x},z [\bar{v},\bar{u},w]$	(8) $\bar{x}+y,y,z [\bar{u}+v,v,w]$	(9) $x,x-y,z [u,u-v,w]$
	(10) $\bar{y},\bar{x},\bar{z} [v,u,w]$	(11) $\bar{x}+y,y,\bar{z} [u-v,\bar{v},w]$	(12) $x,x-y,\bar{z} [\bar{u},\bar{u}+v,w]$
6 h .m'	$x,\bar{x},z [u,\bar{u},w]$	$x,2x,z [u,2u,w]$	$2\bar{x},\bar{x},z [2\bar{u},\bar{u},w]$
	$x,\bar{x},\bar{z} [\bar{u},u,w]$	$x,2x,\bar{z} [\bar{u},2\bar{u},w]$	$2\bar{x},\bar{x},\bar{z} [2u,u,w]$
6 g m'..	$x,y,1/2 [u,v,0]$	$\bar{y},x-y,1/2 [\bar{v},u-v,0]$	$\bar{x}+y,\bar{x},1/2 [\bar{u}+v,\bar{u},0]$
	$\bar{y},\bar{x},1/2 [\bar{v},\bar{u},0]$	$\bar{x}+y,y,1/2 [\bar{u}+v,v,0]$	$x,x-y,1/2 [u,u-v,0]$
6 f m..	$x,y,0 [0,0,w]$	$\bar{y},x-y,0 [0,0,w]$	$\bar{x}+y,\bar{x},0 [0,0,w]$
	$\bar{y},\bar{x},0 [0,0,w]$	$\bar{x}+y,y,0 [0,0,w]$	$x,x-y,0 [0,0,w]$
3 e m'm'2	$x,\bar{x},1/2 [u,\bar{u},0]$	$x,2x,1/2 [u,2u,0]$	$2\bar{x},\bar{x},1/2 [2\bar{u},\bar{u},0]$
3 d mm'2'	$x,\bar{x},0 [0,0,w]$	$x,2x,0 [0,0,w]$	$2\bar{x},\bar{x},0 [0,0,w]$
2 c 3m'	$0,0,z [0,0,w]$	$0,0,\bar{z} [0,0,w]$	
1 b $\bar{6}m'2$	$0,0,1/2 [0,0,0]$		
1 a $\bar{6}m'2'$	$0,0,0 [0,0,w]$		

Continued

No. 71.6.362

$p_{2c} \bar{6}m'2'$

Symmetry of special projections

Along [001] $3m'1'$

Origin at 0,0,z

Along [100] $p_{2a^*} 1m1$

$a^* = c$

Origin at x,0,0

Along [210] $p_{2a^*} 2'mm'$

$a^* = c$

Origin at x,x/2,0

$\rho_{2c} \bar{6}m2$ $\bar{6}m21'$

Hexagonal

No. 71.7.363

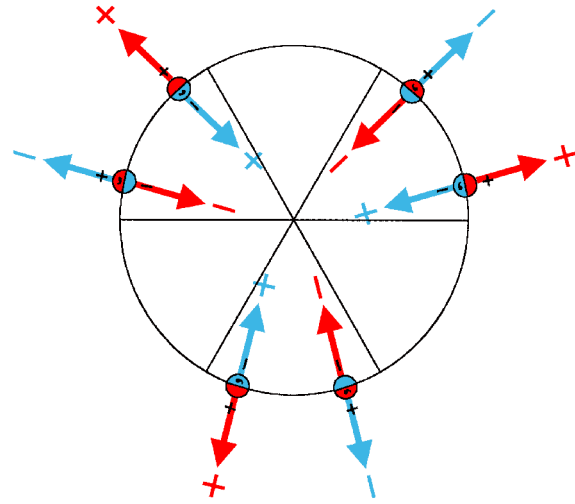
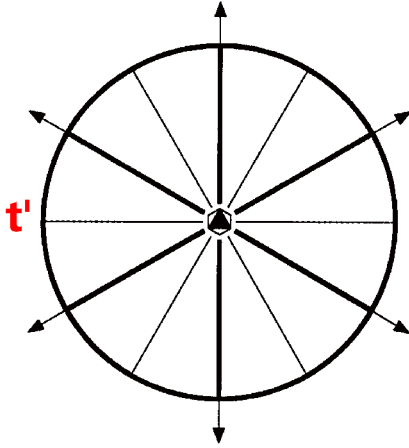
 $\rho_{2c} \bar{6}m2$ Origin on $\bar{6}m2$ Asymmetric unit $y \leq x/2$; $y \geq -x$; $0 \leq z \leq 1/2$

Symmetry operations

(1) 1
(1|0,0,0)

(2) 3^+ 0,0,z
(3_z |0,0,0)

(3) 3^- 0,0,z
(3_z^{-1} |0,0,0)

(4) m x,y,0
(m_z |0,0,0)

(5) $\bar{6}^-$ 0,0,z; 0,0,0
($\bar{6}_z^{-1}$ |0,0,0)

(6) $\bar{6}^+$ 0,0,z; 0,0,0
($\bar{6}_z$ |0,0,0)

(7) m x, \bar{x} ,z
(m_{xy} |0,0,0)

(8) m x,2x,z
(m_x |0,0,0)

(9) m 2x,x,z
(m_y |0,0,0)

(10) 2 x, \bar{x} ,0
(2_3 |0,0,0)

(11) 2 x,2x,0
(2_2 |0,0,0)

(12) 2 2x,x,0
(2_1 |0,0,0)

For (0,0,1)' + set

(1) t' (0,0,1)
(1|0,0,0)'

(2) $3^{+'}$ (0,0,1) 0,0,z
(3_z |0,0,1)'

(3) $3^{-'}$ (0,0,1) 0,0,z
(3_z^{-1} |0,0,1)'

(4) m' x,y,1/2
(m_z |0,0,1)'

(5) $\bar{6}^{-'}$ 0,0,z; 0,0,1/2
($\bar{6}_z^{-1}$ |0,0,1)'

(6) $\bar{6}^{+'}$ 0,0,z; 0,0,1/2
($\bar{6}_z$ |0,0,1)'

(7) c' (0,0,1) x, \bar{x} ,z
(m_{xy} |0,0,1)'

(8) c' (0,0,1) x,2x,z
(m_x |0,0,1)'

(9) c' (0,0,1) 2x,x,z
(m_y |0,0,1)'

(10) 2' x, \bar{x} ,1/2
(2_3 |0,0,1)'

(11) 2' x,2x,1/2
(2_2 |0,0,1)'

(12) 2' 2x,x,1/2
(2_1 |0,0,1)'

Generators selected (1); $t(0,0,1)'$; (2); (4); (7)

Positions

Multiplicity, Wyckoff letter, Site symmetry	Coordinates		
		(0,0,0) ⁺	(0,0,1)' +
12 i 1	(1) x,y,z [u,v,w]	(2) $\bar{y},x-y,z$ [$\bar{v},u-v,w$]	(3) $\bar{x}+y,\bar{x},z$ [$\bar{u}+v,\bar{u},w$]
	(4) x,y,\bar{z} [\bar{u},\bar{v},w]	(5) $\bar{y},x-y,\bar{z}$ [$v,\bar{u}+v,w$]	(6) $\bar{x}+y,\bar{x},\bar{z}$ [$u-v,u,w$]
	(7) \bar{y},\bar{x},z [v,u,\bar{w}]	(8) $\bar{x}+y,y,z$ [$u-v,\bar{v},\bar{w}$]	(9) $x,x-y,z$ [$\bar{u},\bar{u}+v,\bar{w}$]
	(10) \bar{y},\bar{x},\bar{z} [\bar{v},\bar{u},\bar{w}]	(11) $\bar{x}+y,y,\bar{z}$ [$\bar{u}+v,v,\bar{w}$]	(12) $x,x-y,\bar{z}$ [$u,u-v,\bar{w}$]
6 h .m.	x,\bar{x},z [u,u,0]	$x,2x,z$ [$\bar{u},0,0$]	$2\bar{x},\bar{x},z$ [0, $\bar{u},0$]
	x,\bar{x},\bar{z} [$\bar{u},\bar{u},0$]	$x,2x,\bar{z}$ [u,0,0]	$2\bar{x},\bar{x},\bar{z}$ [0,u,0]
6 g m'..	$x,y,1/2$ [u,v,0]	$\bar{y},x-y,1/2$ [$\bar{v},u-v,0$]	$\bar{x}+y,\bar{x},1/2$ [$\bar{u}+v,\bar{u},0$]
	$\bar{y},\bar{x},1/2$ [v,u,0]	$\bar{x}+y,y,1/2$ [$u-v,\bar{v},0$]	$x,x-y,1/2$ [$\bar{u},\bar{u}+v,0$]
6 f m..	$x,y,0$ [0,0,w]	$\bar{y},x-y,0$ [0,0,w]	$\bar{x}+y,\bar{x},0$ [0,0,w]
	$\bar{y},\bar{x},0$ [0,0, \bar{w}]	$\bar{x}+y,y,0$ [0,0, \bar{w}]	$x,x-y,0$ [0,0, \bar{w}]
3 e m'm2'	$x,\bar{x},1/2$ [u,u,0]	$x,2x,1/2$ [$\bar{u},0,0$]	$2\bar{x},\bar{x},1/2$ [0, $\bar{u},0$]
3 d mm2	$x,\bar{x},0$ [u, $\bar{u},0$]	$x,2x,0$ [u,2u,0]	$2\bar{x},\bar{x},0$ [2 $\bar{u},\bar{u},0$]
2 c 3m.	0,0,z [0,0,0]	0,0, \bar{z} [0,0,0]	
1 b $\bar{6}m2'$	0,0,1/2 [0,0,0]		
1 a $\bar{6}m2$	0,0,0 [0,0,0]		

Continued

No. 71.7.363

$p_{2c}\bar{6}m2$

Symmetry of special projections

Along [001] $3m1'$

Origin at 0,0,z

Along [100] $p1m11'$

$a^* = c$

Origin at x,0,0

Along [210] $p_{2a^*}2mm$

$a^* = c$

Origin at x,x/2,0

$\overline{p6c2}$

No. 72.1.364

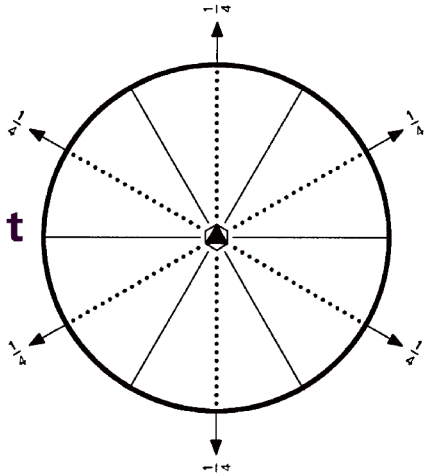

$\overline{6m2}$

$\overline{p6c2}$

Hexagonal

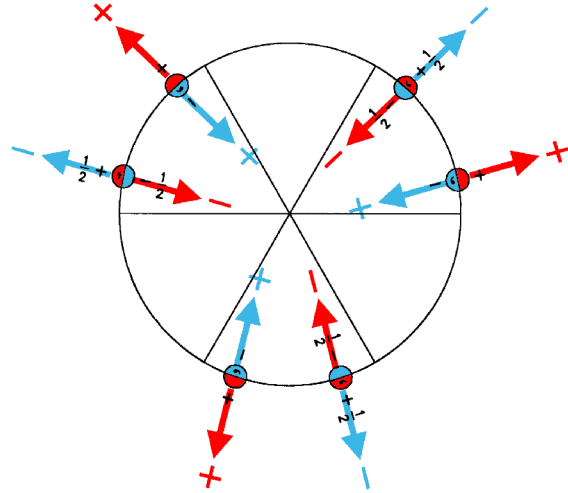

Origin on $\overline{6c1}$

Asymmetric unit $0 \leq x; 0 \leq y; 0 \leq z \leq 1/4$

Symmetry operations

- | | | |
|---|--|---|
| (1) 1
(1 0,0,0) | (2) 3^+ 0,0,z
(3_z 0,0,0) | (3) 3^- 0,0,z
(3_z^{-1} 0,0,0) |
| (4) m x,y,0
(m_z 0,0,0) | (5) $\overline{6}^-$ 0,0,z; 0,0,0
($\overline{6}_z^{-1}$ 0,0,0) | (6) $\overline{6}^+$ 0,0,z; 0,0,0
($\overline{6}_z$ 0,0,0) |
| (7) c (0,0,1/2) x, \bar{x} ,z
(m_{xy} 0,0,1/2) | (8) c (0,0,1/2) x,2x,z
(m_x 0,0,1/2) | (9) c (0,0,1/2) 2x,x,z
(m_y 0,0,1/2) |
| (10) 2 x, \bar{x} ,1/4
(2_3 0,0,1/2) | (11) 2 x,2x,1/4
(2_2 0,0,1/2) | (12) 2 2x,x,1/4
(2_1 0,0,1/2) |

Generators selected (1); $t(0,0,1)$; (2); (4); (7)

Positions

	Coordinates		
Multiplicity, Wyckoff letter, Site symmetry			
12 f 1	(1) x,y,z [u,v,w]	(2) $\bar{y},x-y,z$ [$\bar{v},u-v,w$]	(3) $\bar{x}+y,\bar{x},z$ [$\bar{u}+v,\bar{u},w$]
	(4) x,y,\bar{z} [\bar{u},\bar{v},w]	(5) $\bar{y},x-y,\bar{z}$ [$v,\bar{u}+v,w$]	(6) $\bar{x}+y,\bar{x},\bar{z}$ [$u-v,u,w$]
	(7) $\bar{y},\bar{x},z+1/2$ [v,u,\bar{w}]	(8) $\bar{x}+y,y,z+1/2$ [$u-v,\bar{v},\bar{w}$]	(9) $x,x-y,z+1/2$ [$\bar{u},\bar{u}+v,\bar{w}$]
	(10) $\bar{y},\bar{x},\bar{z}+1/2$ [\bar{v},\bar{u},\bar{w}]	(11) $\bar{x}+y,y,\bar{z}+1/2$ [$\bar{u}+v,v,\bar{w}$]	(12) $x,x-y,\bar{z}+1/2$ [$u,u-v,\bar{w}$]
6 e m..	$x,y,0$ [$0,0,w$]	$\bar{y},x-y,0$ [$0,0,w$]	$\bar{x}+y,\bar{x},0$ [$0,0,w$]
	$\bar{y},\bar{x},1/2$ [$0,0,\bar{w}$]	$\bar{x}+y,y,1/2$ [$0,0,\bar{w}$]	$x,x-y,1/2$ [$0,0,\bar{w}$]
6 d ..2	$x,\bar{x},1/4$ [$u,\bar{u},0$]	$x,2x,1/4$ [$u,2u,0$]	$2\bar{x},\bar{x},1/4$ [$2\bar{u},\bar{u},0$]
	$x,\bar{x},3/4$ [$\bar{u},u,0$]	$x,2x,3/4$ [$\bar{u},2\bar{u},0$]	$2\bar{x},\bar{x},3/4$ [$2u,u,0$]
4 c 3..	$0,0,z$ [$0,0,w$]	$0,0,\bar{z}$ [$0,0,w$]	
	$0,0,z+1/2$ [$0,0,\bar{w}$]	$0,0,\bar{z}+1/2$ [$0,0,\bar{w}$]	
2 b $\bar{6}$..	$0,0,0$ [$0,0,w$]	$0,0,1/2$ [$0,0,\bar{w}$]	
2 a 3.2	$0,0,1/4$ [$0,0,0$]	$0,0,3/4$ [$0,0,0$]	

Symmetry of special projections

Along [001] $3m1'$	Along [100] $p_{2a^*}1m1$	Along [210] $p2mg$
Origin at $0,0,z$	$a^* = c/2$ Origin at $x,0,0$	$a^* = c$ Origin at $x,x/2,1/4$

$\bar{p}\bar{6}c21'$

$\bar{6}m21'$

Hexagonal

No. 72.2.365

$\bar{p}\bar{6}c21'$

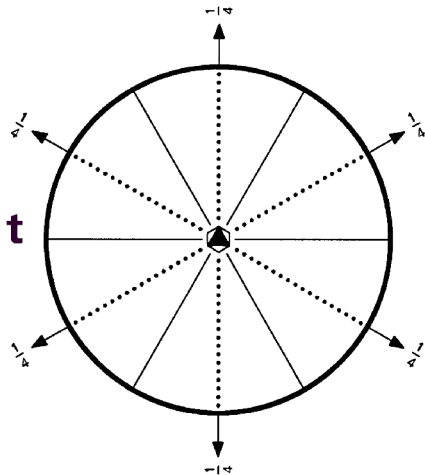

1'

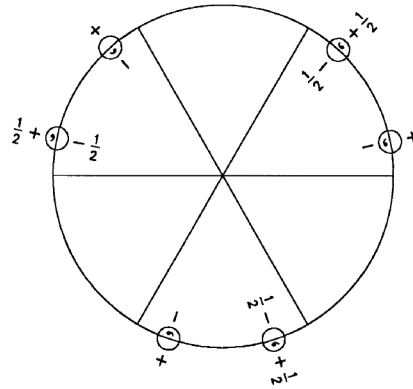

Origin on $\bar{6}c11'$

Asymmetric unit $0 \leq x; 0 \leq y; 0 \leq z \leq 1/4$

Symmetry operations

For 1 + set

- | | | |
|---|--|---|
| (1) 1
(1 0,0,0) | (2) 3^+ 0,0,z
(3_z 0,0,0) | (3) 3^- 0,0,z
(3_z^{-1} 0,0,0) |
| (4) m x,y,0
(m_z 0,0,0) | (5) $\bar{6}^-$ 0,0,z; 0,0,0
($\bar{6}_z^{-1}$ 0,0,0) | (6) $\bar{6}^+$ 0,0,z; 0,0,0
($\bar{6}_z$ 0,0,0) |
| (7) c (0,0,1/2) x, \bar{x} ,z
(m_{xy} 0,0,1/2) | (8) c (0,0,1/2) x,2x,z
(m_x 0,0,1/2) | (9) c (0,0,1/2) 2x,x,z
(m_y 0,0,1/2) |
| (10) 2 x, \bar{x} ,1/4
(2_3 0,0,1/2) | (11) 2 x,2x,1/4
(2_2 0,0,1/2) | (12) 2 2x,x,1/4
(2_1 0,0,1/2) |

For 1' + set

- | | | |
|---|--|---|
| (1) 1'
(1 0,0,0)' | (2) $3^{+'}$ 0,0,z
(3_z 0,0,0)' | (3) $3^{-'}$ 0,0,z
(3_z^{-1} 0,0,0)' |
| (4) m' x,y,0
(m_z 0,0,0)' | (5) $\bar{6}^{-'}$ 0,0,z; 0,0,0
($\bar{6}_z^{-1}$ 0,0,0)' | (6) $\bar{6}^{+'}$ 0,0,z; 0,0,0
($\bar{6}_z$ 0,0,0)' |
| (7) c' (0,0,1/2) x, \bar{x} ,z
(m_{xy} 0,0,1/2)' | (8) c' (0,0,1/2) x,2x,z
(m_x 0,0,1/2)' | (9) c' (0,0,1/2) 2x,x,z
(m_y 0,0,1/2)' |
| (10) 2' x, \bar{x} ,1/4
(2_3 0,0,1/2)' | (11) 2' x,2x,1/4
(2_2 0,0,1/2)' | (12) 2' 2x,x,1/4
(2_1 0,0,1/2)' |

Generators selected (1); $t(0,0,1)$; (2); (4); (7); $1'$

Positions

Multiplicity, Wyckoff letter, Site symmetry	Coordinates		
		$1+$	$1'+$
12 f $11'$	(1) x,y,z [0,0,0]	(2) $\bar{y},x-y,z$ [0,0,0]	(3) $\bar{x}+y,\bar{x},z$ [0,0,0]
	(4) x,y,\bar{z} [0,0,0]	(5) $\bar{y},x-y,\bar{z}$ [0,0,0]	(6) $\bar{x}+y,\bar{x},\bar{z}$ [0,0,0]
	(7) $\bar{y},\bar{x},z+1/2$ [0,0,0]	(8) $\bar{x}+y,y,z+1/2$ [0,0,0]	(9) $x,x-y,z+1/2$ [0,0,0]
	(10) $\bar{y},\bar{x},\bar{z}+1/2$ [0,0,0]	(11) $\bar{x}+y,y,\bar{z}+1/2$ [0,0,0]	(12) $x,x-y,\bar{z}+1/2$ [0,0,0]
6 e $m..1'$	$x,y,0$ [0,0,0]	$\bar{y},x-y,0$ [0,0,0]	$\bar{x}+y,\bar{x},0$ [0,0,0]
	$\bar{y},\bar{x},1/2$ [0,0,0]	$\bar{x}+y,y,1/2$ [0,0,0]	$x,x-y,1/2$ [0,0,0]
6 d $..21'$	$x,\bar{x},1/4$ [0,0,0]	$x,2x,1/4$ [0,0,0]	$2\bar{x},\bar{x},1/4$ [0,0,0]
	$x,\bar{x},3/4$ [0,0,0]	$x,2x,3/4$ [0,0,0]	$2\bar{x},\bar{x},3/4$ [0,0,0]
4 c $3..1'$	$0,0,z$ [0,0,0]	$0,0,\bar{z}$ [0,0,0]	
	$0,0,z+1/2$ [0,0,0]	$0,0,\bar{z}+1/2$ [0,0,0]	
2 b $\bar{6}..1'$	$0,0,0$ [0,0,0]	$0,0,1/2$ [0,0,0]	
2 a $3.21'$	$0,0,1/4$ [0,0,0]	$0,0,3/4$ [0,0,0]	

Symmetry of special projections

Along [001] $3m1'$	Along [100] $p1m11'$	Along [210] $p2mg1'$
Origin at $0,0,z$	$a^* = c/2$ Origin at $x,0,0$	$a^* = c$ Origin at $x,x/2,1/4$

$\overline{p6c}2'$

No. 72.3.366

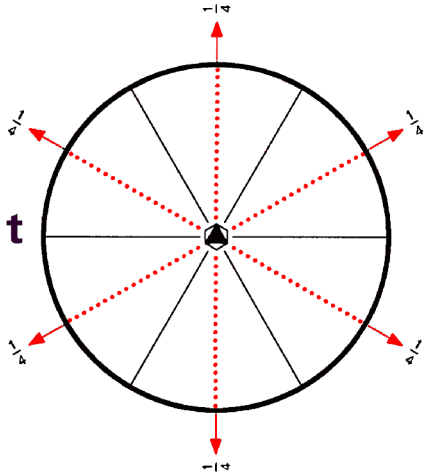

$\overline{6m}2'$

$\overline{p6c}2'$

Hexagonal

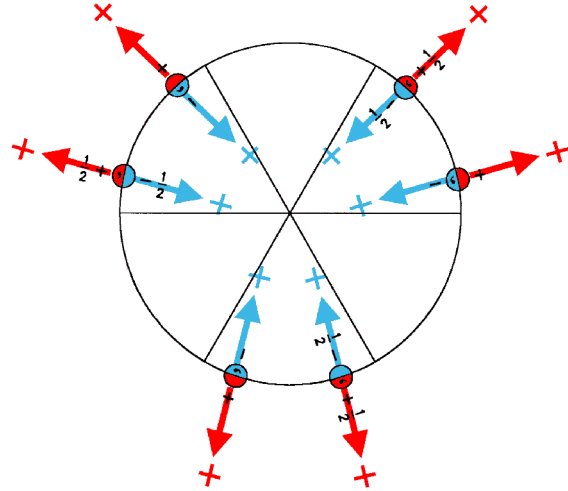

Origin on $\overline{6c}1$

Asymmetric unit $0 \leq x; 0 \leq y; 0 \leq z \leq 1/4$

Symmetry operations

- | | | |
|---|--|---|
| (1) 1
(1 0,0,0) | (2) 3^+ 0,0,z
(3_z 0,0,0) | (3) 3^- 0,0,z
(3_z^{-1} 0,0,0) |
| (4) m x,y,0
(m_z 0,0,0) | (5) $\overline{6}^-$ 0,0,z; 0,0,0
($\overline{6}_z^{-1}$ 0,0,0) | (6) $\overline{6}^+$ 0,0,z; 0,0,0
($\overline{6}_z$ 0,0,0) |
| (7) c' (0,0,1/2) x, \bar{x} ,z
(m_{xy} 0,0,1/2)' | (8) c' (0,0,1/2) x,2x,z
(m_x 0,0,1/2)' | (9) c' (0,0,1/2) 2x,x,z
(m_y 0,0,1/2)' |
| (10) $2'$ x, \bar{x} ,1/4
(2_3 0,0,1/2)' | (11) $2'$ x,2x,1/4
(2_2 0,0,1/2)' | (12) $2'$ 2x,x,1/4
(2_1 0,0,1/2)' |

Generators selected (1); $t(0,0,1)$; (2); (4); (7)

Positions

	Coordinates		
Multiplicity, Wyckoff letter, Site symmetry			
12 f 1	(1) x,y,z [u,v,w]	(2) $\bar{y},x-y,z$ [$\bar{v},u-v,w$]	(3) $\bar{x}+y,\bar{x},z$ [$\bar{u}+v,\bar{u},w$]
	(4) x,y,\bar{z} [\bar{u},\bar{v},w]	(5) $\bar{y},x-y,\bar{z}$ [$v,\bar{u}+v,w$]	(6) $\bar{x}+y,\bar{x},\bar{z}$ [$u-v,u,w$]
	(7) $\bar{y},\bar{x},z+1/2$ [\bar{v},\bar{u},w]	(8) $\bar{x}+y,y,z+1/2$ [$\bar{u}+v,v,w$]	(9) $x,x-y,z+1/2$ [$u,u-v,w$]
	(10) $\bar{y},\bar{x},\bar{z}+1/2$ [v,u,w]	(11) $\bar{x}+y,y,\bar{z}+1/2$ [$u-v,\bar{v},w$]	(12) $x,x-y,\bar{z}+1/2$ [$\bar{u},\bar{u}+v,w$]
6 e m..	$x,y,0$ [$0,0,w$]	$\bar{y},x-y,0$ [$0,0,w$]	$\bar{x}+y,\bar{x},0$ [$0,0,w$]
	$\bar{y},\bar{x},1/2$ [$0,0,w$]	$\bar{x}+y,y,1/2$ [$0,0,w$]	$x,x-y,1/2$ [$0,0,w$]
6 d ..2'	$x,\bar{x},1/4$ [u,u,w]	$x,2x,1/4$ [$\bar{u},0,w$]	$2\bar{x},\bar{x},1/4$ [$0,\bar{u},w$]
	$x,\bar{x},3/4$ [\bar{u},\bar{u},w]	$x,2x,3/4$ [$u,0,w$]	$2\bar{x},\bar{x},3/4$ [$0,u,w$]
4 c 3..	$0,0,z$ [$0,0,w$]	$0,0,\bar{z}$ [$0,0,w$]	
	$0,0,z+1/2$ [$0,0,w$]	$0,0,\bar{z}+1/2$ [$0,0,w$]	
2 b $\bar{6}$..	$0,0,0$ [$0,0,w$]	$0,0,1/2$ [$0,0,w$]	
2 a 3.2'	$0,0,1/4$ [$0,0,w$]	$0,0,3/4$ [$0,0,w$]	

Symmetry of special projections

Along [001] $3m1'$	Along [100] $p1m1$	Along [210] $p2'mg'$
Origin at $0,0,z$	$a^* = c/2$ Origin at $x,0,0$	$a^* = c$ Origin at $x,x/2,1/4$

$\bar{p}\bar{6}'c2'$

No. 72.4.367

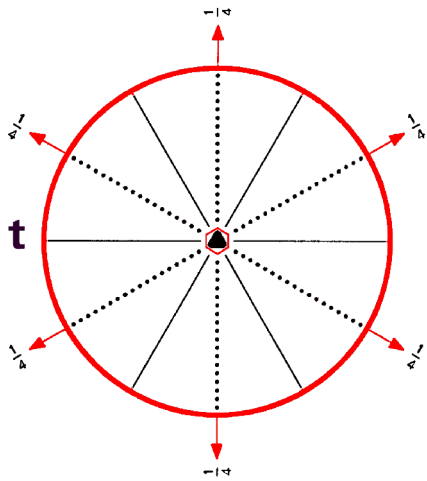

$\bar{6}'m2'$

$\bar{p}\bar{6}'c2'$

Hexagonal

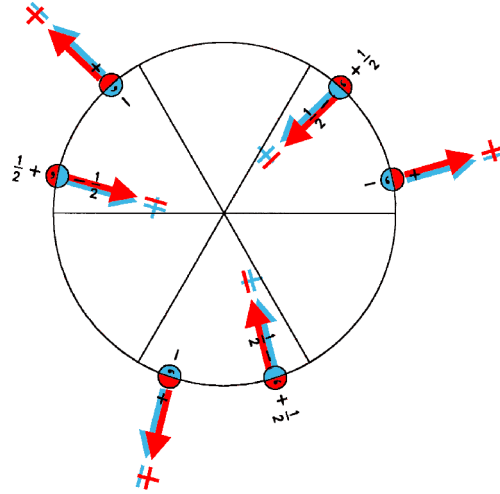

Origin on $\bar{6}'c1$

Asymmetric unit $0 \leq x; 0 \leq y; 0 \leq z \leq 1/4$

Symmetry operations

- | | | |
|---|---|--|
| (1) 1
(1 0,0,0) | (2) 3^+ 0,0,z
(3_z 0,0,0) | (3) 3^- 0,0,z
(3_z^{-1} 0,0,0) |
| (4) m' x,y,0
(m_z 0,0,0)' | (5) $\bar{6}^-$ 0,0,z; 0,0,0
($\bar{6}_z^{-1}$ 0,0,0)' | (6) $\bar{6}^+$ 0,0,z; 0,0,0
($\bar{6}_z$ 0,0,0)' |
| (7) c (0,0,1/2) x, \bar{x} ,z
(m_{xy} 0,0,1/2) | (8) c (0,0,1/2) x,2x,z
(m_x 0,0,1/2) | (9) c (0,0,1/2) 2x,x,z
(m_y 0,0,1/2) |
| (10) $2'$ x, \bar{x} ,1/4
(2_3 0,0,1/2)' | (11) $2'$ x,2x,1/4
(2_2 0,0,1/2)' | (12) $2'$ 2x,x,1/4
(2_1 0,0,1/2)' |

Generators selected (1); $t(0,0,1)$; (2); (4); (7)

Positions

	Coordinates		
Multiplicity, Wyckoff letter, Site symmetry			
12 f 1	(1) x,y,z [u,v,w]	(2) $\bar{y},x-y,z$ [$\bar{v},u-v,w$]	(3) $\bar{x}+y,\bar{x},z$ [$\bar{u}+v,\bar{u},w$]
	(4) x,y,\bar{z} [u,v, \bar{w}]	(5) $\bar{y},x-y,\bar{z}$ [$\bar{v},u-v,\bar{w}$]	(6) $\bar{x}+y,\bar{x},\bar{z}$ [$\bar{u}+v,\bar{u},\bar{w}$]
	(7) $\bar{y},\bar{x},z+1/2$ [v,u, \bar{w}]	(8) $\bar{x}+y,y,z+1/2$ [u-v, \bar{v},\bar{w}]	(9) $x,x-y,z+1/2$ [$\bar{u},\bar{u}+v,\bar{w}$]
	(10) $\bar{y},\bar{x},\bar{z}+1/2$ [v,u,w]	(11) $\bar{x}+y,y,\bar{z}+1/2$ [u-v, \bar{v},w]	(12) $x,x-y,\bar{z}+1/2$ [$\bar{u},\bar{u}+v,w$]
6 e m'..	$x,y,0$ [u,v,0]	$\bar{y},x-y,0$ [$\bar{v},u-v,0$]	$\bar{x}+y,\bar{x},0$ [$\bar{u}+v,\bar{u},0$]
	$\bar{y},\bar{x},1/2$ [v,u,0]	$\bar{x}+y,y,1/2$ [u-v, $\bar{v},0$]	$x,x-y,1/2$ [$\bar{u},\bar{u}+v,0$]
6 d ..2'	$x,\bar{x},1/4$ [u,u,w]	$x,2x,1/4$ [$\bar{u},0,w$]	$2\bar{x},\bar{x},1/4$ [0, \bar{u},w]
	$x,\bar{x},3/4$ [u,u, \bar{w}]	$x,2x,3/4$ [0, \bar{u},\bar{w}]	$2\bar{x},\bar{x},3/4$ [$\bar{u},0,\bar{w}$]
4 c 3..	$0,0,z$ [0,0,w]	$0,0,\bar{z}$ [0,0, \bar{w}]	
	$0,0,z+1/2$ [0,0, \bar{w}]	$0,0,\bar{z}+1/2$ [0,0,w]	
2 b $\bar{6}'..$	$0,0,0$ [0,0,0]	$0,0,1/2$ [0,0,0]	
2 a 3.2'	$0,0,1/4$ [0,0,w]	$0,0,3/4$ [0,0, \bar{w}]	

Symmetry of special projections

Along [001] 3m	Along [100] $p_{2a^*}1m'1$	Along [210] $p2'm'g$
Origin at 0,0,z	$a^* = c/2$ Origin at x,0,0	$a^* = c$ Origin at x,x/2,1/4

$\bar{p}\bar{6}'c'2$

No. 72.5.368

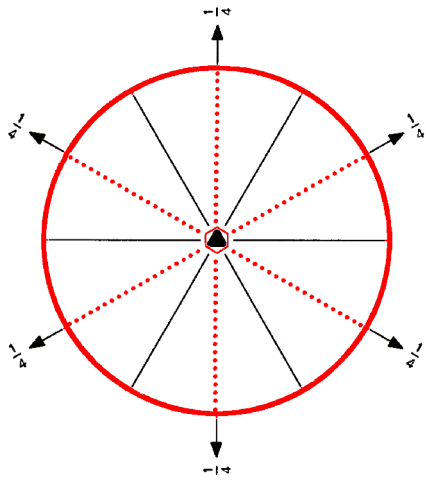

$\bar{6}'m'2$

$\bar{p}\bar{6}'c'2$

Hexagonal

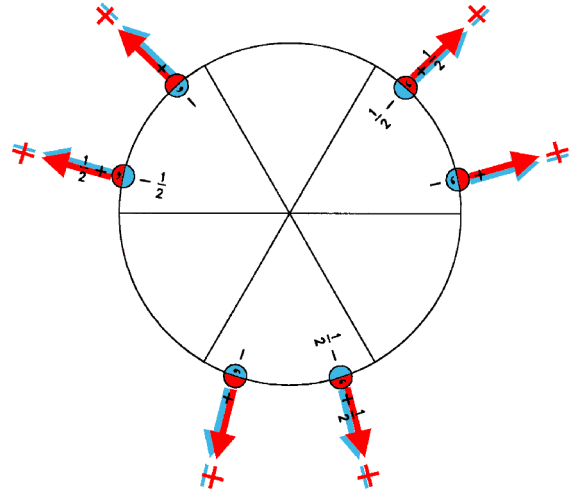

Origin on $\bar{6}'c'1$

Asymmetric unit $0 \leq x; 0 \leq y; 0 \leq z \leq 1/4$

Symmetry operations

- | | | |
|---|--|---|
| (1) 1
(1 0,0,0) | (2) 3^+ 0,0,z
(3_z 0,0,0) | (3) 3^- 0,0,z
(3_z^{-1} 0,0,0) |
| (4) m' x,y,0
(m_z 0,0,0)' | (5) $\bar{6}'$ 0,0,z; 0,0,0
($\bar{6}_z^{-1}$ 0,0,0)' | (6) $\bar{6}^{+'}$ 0,0,z; 0,0,0
($\bar{6}_z$ 0,0,0)' |
| (7) c' (0,0,1/2) x, \bar{x} ,z
(m_{xy} 0,0,1/2)' | (8) c' (0,0,1/2) x,2x,z
(m_x 0,0,1/2)' | (9) c' (0,0,1/2) 2x,x,z
(m_y 0,0,1/2)' |
| (10) 2 x, \bar{x} ,1/4
(2_3 0,0,1/2) | (11) 2 x,2x,1/4
(2_2 0,0,1/2) | (12) 2 2x,x,1/4
(2_1 0,0,1/2) |

Generators selected (1); $t(0,0,1)$; (2); (4); (7)

Positions

	Coordinates		
Multiplicity, Wyckoff letter, Site symmetry			
12 f 1	(1) x,y,z [u,v,w]	(2) $\bar{y},x-y,z$ [$\bar{v},u-v,w$]	(3) $\bar{x}+y,\bar{x},z$ [$\bar{u}+v,\bar{u},w$]
	(4) x,y,\bar{z} [u,v,\bar{w}]	(5) $\bar{y},x-y,\bar{z}$ [$\bar{v},u-v,\bar{w}$]	(6) $\bar{x}+y,\bar{x},\bar{z}$ [$\bar{u}+v,\bar{u},\bar{w}$]
	(7) $\bar{y},\bar{x},z+1/2$ [\bar{v},\bar{u},w]	(8) $\bar{x}+y,y,z+1/2$ [$\bar{u}+v,v,w$]	(9) $x,x-y,z+1/2$ [$u,u-v,w$]
	(10) $\bar{y},\bar{x},\bar{z}+1/2$ [\bar{v},\bar{u},\bar{w}]	(11) $\bar{x}+y,y,\bar{z}+1/2$ [$\bar{u}+v,v,\bar{w}$]	(12) $x,x-y,\bar{z}+1/2$ [$u,u-v,\bar{w}$]
6 e m'..	$x,y,0$ [$u,v,0$]	$\bar{y},x-y,0$ [$\bar{v},u-v,0$]	$\bar{x}+y,\bar{x},0$ [$\bar{u}+v,\bar{u},0$]
	$\bar{y},\bar{x},1/2$ [$\bar{v},\bar{u},0$]	$\bar{x}+y,y,1/2$ [$\bar{u}+v,v,0$]	$x,x-y,1/2$ [$u,u-v,0$]
6 d ..2	$x,\bar{x},1/4$ [$u,\bar{u},0$]	$x,2x,1/4$ [$u,2u,0$]	$2\bar{x},\bar{x},1/4$ [$2\bar{u},\bar{u},0$]
	$x,\bar{x},3/4$ [$u,\bar{u},0$]	$x,2x,3/4$ [$2\bar{u},\bar{u},0$]	$2\bar{x},\bar{x},3/4$ [$u,2u,0$]
4 c 3..	$0,0,z$ [$0,0,w$]	$0,0,\bar{z}$ [$0,0,\bar{w}$]	
	$0,0,z+1/2$ [$0,0,w$]	$0,0,\bar{z}+1/2$ [$0,0,\bar{w}$]	
2 b $\bar{6}'..$	$0,0,0$ [$0,0,0$]	$0,0,1/2$ [$0,0,0$]	
2 a 3.2	$0,0,1/4$ [$0,0,0$]	$0,0,3/4$ [$0,0,0$]	

Symmetry of special projections

Along [001] $3m'$	Along [100] $p1m'1$	Along [210] $p2m'g'$
Origin at $0,0,z$	$a^* = c/2$ Origin at $x,0,0$	$a^* = c$ Origin at $x,x/2,1/4$

$p6/mmm$

$6/mmm$

Hexagonal

No. 73.1.369

$p6/m2/m2/m$

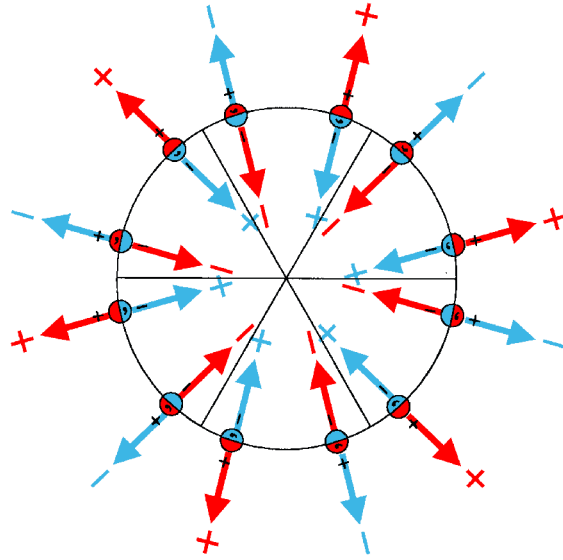
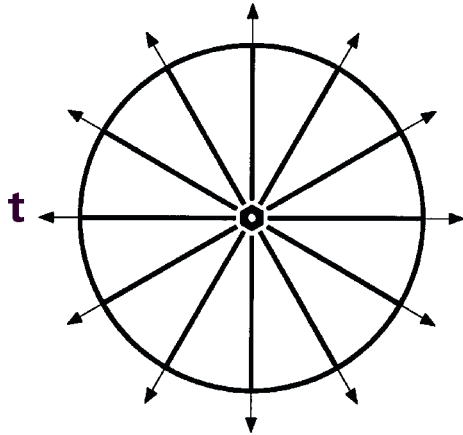

Origin at center ($6/mmm$)

Asymmetric unit $0 \leq x$; $0 \leq y$; $0 \leq z \leq 1/2$; $y \leq x/2$

Symmetry operations

- | | | |
|--|---|---|
| (1) 1
(1 0,0,0) | (2) 3^+ 0,0,z
(3_z 0,0,0) | (3) 3^- 0,0,z
(3_z^{-1} 0,0,0) |
| (4) 2 0,0,z
(2_z 0,0,0) | (5) 6^- 0,0,z
(6_z^{-1} 0,0,0) | (6) 6^+ 0,0,z
(6_z 0,0,0) |
| (7) 2 x,x,0
(2_{xy} 0,0,0) | (8) 2 x,0,0
(2_x 0,0,0) | (9) 2 0,y,0
(2_y 0,0,0) |
| (10) 2 x, \bar{x} ,0
(2_3 0,0,0) | (11) 2 x,2x,0
(2_2 0,0,0) | (12) 2 2x,x,0
(2_1 0,0,0) |
| (13) $\bar{1}$ 0,0,0
($\bar{1}$ 0,0,0) | (14) $\bar{3}^+$ 0,0,z; 0,0,0
($\bar{3}_z$ 0,0,0) | (15) $\bar{3}^-$ 0,0,z; 0,0,0
($\bar{3}_z^{-1}$ 0,0,0) |
| (16) m x,y,0
(m_z 0,0,0) | (17) $\bar{6}^-$ 0,0,z; 0,0,0
($\bar{6}_z^{-1}$ 0,0,0) | (18) $\bar{6}^+$ 0,0,z; 0,0,0
($\bar{6}_z$ 0,0,0) |
| (19) m x, \bar{x} ,z
(m_{xy} 0,0,0) | (20) m x,2x,z
(m_x 0,0,0) | (21) m 2x,x,z
(m_y 0,0,0) |
| (22) m x,x,z
(m_3 0,0,0) | (23) m x,0,z
(m_2 0,0,0) | (24) m 0,y,z
(m_1 0,0,0) |

Generators selected (1); t(0,0,1); (2); (4); (7); (13)

Positions

	Coordinates		
Multiplicity, Wyckoff letter, Site symmetry			
24 l 1	(1) x, y, z [u,v,w]	(2) $\bar{y}, x-y, z$ [$\bar{v}, u-v, w$]	(3) $\bar{x}+y, \bar{x}, z$ [$\bar{u}+v, \bar{u}, w$]
	(4) \bar{x}, \bar{y}, z [\bar{u}, \bar{v}, w]	(5) $y, \bar{x}+y, z$ [$v, \bar{u}+v, w$]	(6) $x-y, x, z$ [u-v,u,w]
	(7) y, x, \bar{z} [v,u, \bar{w}]	(8) $x-y, \bar{y}, \bar{z}$ [u-v, \bar{v}, \bar{w}]	(9) $\bar{x}, \bar{x}+y, \bar{z}$ [$\bar{u}, \bar{u}+v, \bar{w}$]
	(10) $\bar{y}, \bar{x}, \bar{z}$ [$\bar{v}, \bar{u}, \bar{w}$]	(11) $\bar{x}+y, y, \bar{z}$ [$\bar{u}+v, v, \bar{w}$]	(12) $x, x-y, \bar{z}$ [u,u-v, \bar{w}]
	(13) $\bar{x}, \bar{y}, \bar{z}$ [u,v,w]	(14) $y, \bar{x}+y, \bar{z}$ [$\bar{v}, u-v, w$]	(15) $x-y, x, \bar{z}$ [$\bar{u}+v, \bar{u}, w$]
	(16) x, y, \bar{z} [\bar{u}, \bar{v}, w]	(17) $\bar{y}, x-y, \bar{z}$ [$v, \bar{u}+v, w$]	(18) $\bar{x}+y, \bar{x}, \bar{z}$ [u-v,u,w]
	(19) \bar{y}, \bar{x}, z [v,u, \bar{w}]	(20) $\bar{x}+y, y, z$ [u-v, \bar{v}, \bar{w}]	(21) $x, x-y, z$ [$\bar{u}, \bar{u}+v, \bar{w}$]
	(22) y, x, z [$\bar{v}, \bar{u}, \bar{w}$]	(23) $x-y, \bar{y}, z$ [$\bar{u}+v, v, \bar{w}$]	(24) $\bar{x}, \bar{x}+y, z$ [u,u-v, \bar{w}]
12 k m..	$x, y, 1/2$ [0,0,w]	$\bar{y}, x-y, 1/2$ [0,0,w]	$\bar{x}+y, \bar{x}, 1/2$ [0,0,w]
	$\bar{x}, \bar{y}, 1/2$ [0,0,w]	$y, \bar{x}+y, 1/2$ [0,0,w]	$x-y, x, 1/2$ [0,0,w]
	$y, x, 1/2$ [0,0, \bar{w}]	$x-y, \bar{y}, 1/2$ [0,0, \bar{w}]	$\bar{x}, \bar{x}+y, 1/2$ [0,0, \bar{w}]
	$\bar{y}, \bar{x}, 1/2$ [0,0, \bar{w}]	$\bar{x}+y, y, 1/2$ [0,0, \bar{w}]	$x, x-y, 1/2$ [0,0, \bar{w}]
12 j m..	$x, y, 0$ [0,0,w]	$\bar{y}, x-y, 0$ [0,0,w]	$\bar{x}+y, \bar{x}, 0$ [0,0,w]
	$\bar{x}, \bar{y}, 0$ [0,0,w]	$y, \bar{x}+y, 0$ [0,0,w]	$x-y, x, 0$ [0,0,w]
	$y, x, 0$ [0,0, \bar{w}]	$x-y, \bar{y}, 0$ [0,0, \bar{w}]	$\bar{x}, \bar{x}+y, 0$ [0,0, \bar{w}]
	$\bar{y}, \bar{x}, 0$ [0,0, \bar{w}]	$\bar{x}+y, y, 0$ [0,0, \bar{w}]	$x, x-y, 0$ [0,0, \bar{w}]

Continued

No. 73.1.369

p6/mmm

12 i .m.	$x, 2x, z [u, 0, 0]$	$2\bar{x}, \bar{x}, z [0, u, 0]$	$x, \bar{x}, z [\bar{u}, \bar{u}, 0]$
	$\bar{x}, 2\bar{x}, z [\bar{u}, 0, 0]$	$2x, x, z [0, \bar{u}, 0]$	$\bar{x}, x, z [u, u, 0]$
	$2x, x, \bar{z} [0, u, 0]$	$\bar{x}, 2\bar{x}, \bar{z} [u, 0, 0]$	$\bar{x}, x, \bar{z} [\bar{u}, \bar{u}, 0]$
	$2\bar{x}, \bar{x}, \bar{z} [0, \bar{u}, 0]$	$x, 2x, \bar{z} [\bar{u}, 0, 0]$	$x, \bar{x}, \bar{z} [u, u, 0]$
12 h .m	$x, 0, z [u, 2u, 0]$	$0, x, z [2\bar{u}, \bar{u}, 0]$	$\bar{x}, \bar{x}, z [u, \bar{u}, 0]$
	$\bar{x}, 0, z [\bar{u}, 2\bar{u}, 0]$	$0, \bar{x}, z [2u, u, 0]$	$x, x, z [\bar{u}, u, 0]$
	$0, x, \bar{z} [2u, u, 0]$	$x, 0, \bar{z} [\bar{u}, 2\bar{u}, 0]$	$\bar{x}, \bar{x}, \bar{z} [\bar{u}, u, 0]$
	$0, \bar{x}, \bar{z} [2\bar{u}, \bar{u}, 0]$	$\bar{x}, 0, \bar{z} [u, 2u, 0]$	$x, x, \bar{z} [u, \bar{u}, 0]$
6 g mm2	$x, 2x, 1/2 [0, 0, 0]$	$2\bar{x}, \bar{x}, 1/2 [0, 0, 0]$	$x, \bar{x}, 1/2 [0, 0, 0]$
	$\bar{x}, 2\bar{x}, 1/2 [0, 0, 0]$	$2x, x, 1/2 [0, 0, 0]$	$\bar{x}, x, 1/2 [0, 0, 0]$
6 f mm2	$x, 2x, 0 [0, 0, 0]$	$2\bar{x}, \bar{x}, 0 [0, 0, 0]$	$x, \bar{x}, 0 [0, 0, 0]$
	$\bar{x}, 2\bar{x}, 0 [0, 0, 0]$	$2x, x, 0 [0, 0, 0]$	$\bar{x}, x, 0 [0, 0, 0]$
6 e m2m	$x, 0, 1/2 [0, 0, 0]$	$0, x, 1/2 [0, 0, 0]$	$\bar{x}, \bar{x}, 1/2 [0, 0, 0]$
	$\bar{x}, 0, 1/2 [0, 0, 0]$	$0, \bar{x}, 1/2 [0, 0, 0]$	$x, x, 1/2 [0, 0, 0]$
6 d m2m	$x, 0, 0 [0, 0, 0]$	$0, x, 0 [0, 0, 0]$	$\bar{x}, \bar{x}, 0 [0, 0, 0]$
	$\bar{x}, 0, 0 [0, 0, 0]$	$0, \bar{x}, 0 [0, 0, 0]$	$x, x, 0 [0, 0, 0]$
2 c 6mm	$0, 0, z [0, 0, 0]$	$0, 0, \bar{z} [0, 0, 0]$	
1 b 6/mmm	$0, 0, 1/2 [0, 0, 0]$		
1 a 6/mmm	$0, 0, 0 [0, 0, 0]$		

Continued

No. 73.1.369

p6/mmm

Symmetry of special projections

Along [001] 6mm

Origin at 0,0,z

Along [100] $p2mm1'$

$a^* = c$

Origin at x,0,0

Along [210] $p2mm1'$

$a^* = c$

Origin at x,x/2,0

$p6/mmm1'$

$6/mmm1'$

Hexagonal

No. 73.2.370

$p6/m2/m2/m1'$

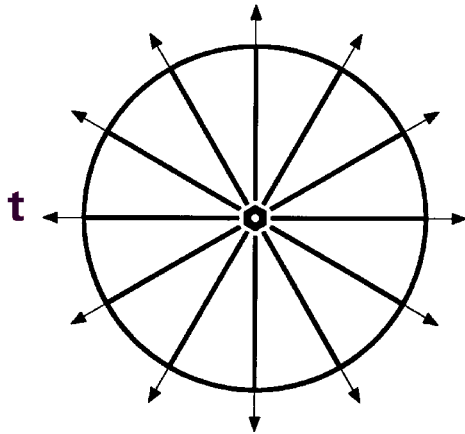

1'

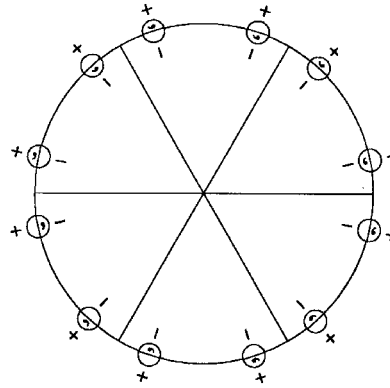

Origin at center ($6/mmm$) $1'$

Asymmetric unit $0 \leq x$; $0 \leq y$; $0 \leq z \leq 1/2$; $y \leq x/2$

Symmetry operations

For $1 +$ set

- | | | |
|---|---|---|
| (1) 1
($1 0,0,0$) | (2) 3^+ $0,0,z$
($3_z 0,0,0$) | (3) 3^- $0,0,z$
($3_z^{-1} 0,0,0$) |
| (4) 2 $0,0,z$
($2_z 0,0,0$) | (5) 6^- $0,0,z$
($6_z^{-1} 0,0,0$) | (6) 6^+ $0,0,z$
($6_z 0,0,0$) |
| (7) 2 $x,x,0$
($2_{xy} 0,0,0$) | (8) 2 $x,0,0$
($2_x 0,0,0$) | (9) 2 $0,y,0$
($2_y 0,0,0$) |
| (10) 2 $x,\bar{x},0$
($2_3 0,0,0$) | (11) 2 $x,2x,0$
($2_2 0,0,0$) | (12) 2 $2x,x,0$
($2_1 0,0,0$) |
| (13) $\bar{1}$ $0,0,0$
($\bar{1} 0,0,0$) | (14) $\bar{3}^+$ $0,0,z; 0,0,0$
($\bar{3}_z 0,0,0$) | (15) $\bar{3}^-$ $0,0,z; 0,0,0$
($\bar{3}_z^{-1} 0,0,0$) |
| (16) m $x,y,0$
($m_z 0,0,0$) | (17) $\bar{6}^-$ $0,0,z; 0,0,0$
($\bar{6}_z^{-1} 0,0,0$) | (18) $\bar{6}^+$ $0,0,z; 0,0,0$
($\bar{6}_z 0,0,0$) |
| (19) m x,\bar{x},z
($m_{xy} 0,0,0$) | (20) m $x,2x,z$
($m_x 0,0,0$) | (21) m $2x,x,z$
($m_y 0,0,0$) |
| (22) m x,x,z
($m_3 0,0,0$) | (23) m $x,0,z$
($m_2 0,0,0$) | (24) m $0,y,z$
($m_1 0,0,0$) |

For 1' + set

$$(1) 1' \\ (1|0,0,0)'$$

$$(4) 2' \quad 0,0,z \\ (2_z|0,0,0)'$$

$$(7) 2' \quad x,x,0 \\ (2_{xy}|0,0,0)'$$

$$(10) 2' \quad x,\bar{x},0 \\ (2_3|0,0,0)'$$

$$(13) \bar{1}' \quad 0,0,0 \\ (\bar{1}|0,0,0)'$$

$$(16) m' \quad x,y,0 \\ (m_z|0,0,0)'$$

$$(19) m' \quad x,\bar{x},z \\ (m_{xy}|0,0,0)'$$

$$(22) m' \quad x,x,z \\ (m_3|0,0,0)'$$

$$(2) 3^{+'} \quad 0,0,z \\ (3_z|0,0,0)'$$

$$(5) 6^{-'} \quad 0,0,z \\ (6_z^{-1}|0,0,0)'$$

$$(8) 2' \quad x,0,0 \\ (2_x|0,0,0)'$$

$$(11) 2' \quad x,2x,0 \\ (2_2|0,0,0)'$$

$$(14) \bar{3}^{+'} \quad 0,0,z; 0,0,0 \\ (\bar{3}_z|0,0,0)'$$

$$(17) \bar{6}^{-'} \quad 0,0,z; 0,0,0 \\ (\bar{6}_z^{-1}|0,0,0)'$$

$$(20) m' \quad x,2x,z \\ (m_x|0,0,0)'$$

$$(23) m' \quad x,0,z \\ (m_2|0,0,0)'$$

$$(3) 3^{-'} \quad 0,0,z \\ (3_z^{-1}|0,0,0)'$$

$$(6) 6^{+'} \quad 0,0,z \\ (6_z|0,0,0)'$$

$$(9) 2' \quad 0,y,0 \\ (2_y|0,0,0)'$$

$$(12) 2' \quad 2x,x,0 \\ (2_1|0,0,0)'$$

$$(15) \bar{3}^{-'} \quad 0,0,z; 0,0,0 \\ (\bar{3}_z^{-1}|0,0,0)'$$

$$(18) \bar{6}^{+'} \quad 0,0,z; 0,0,0 \\ (\bar{6}_z|0,0,0)'$$

$$(21) m' \quad 2x,x,z \\ (m_y|0,0,0)'$$

$$(24) m' \quad 0,y,z \\ (m_1|0,0,0)'$$

Generators selected (1); t(0,0,1); (2); (4); (7); (13); 1'

Positions

Multiplicity, Wyckoff letter, Site symmetry	Coordinates		
		1+	1' +
24 l 11'	(1) x,y,z [0,0,0]	(2) $\bar{y},x-y,z$ [0,0,0]	(3) $\bar{x}+y,\bar{x},z$ [0,0,0]
	(4) \bar{x},\bar{y},z [0,0,0]	(5) $y,\bar{x}+y,z$ [0,0,0]	(6) x-y,x,z [0,0,0]
	(7) y,x, \bar{z} [0,0,0]	(8) x-y, \bar{y},\bar{z} [0,0,0]	(9) $\bar{x},\bar{x}+y,\bar{z}$ [0,0,0]
	(10) \bar{y},\bar{x},\bar{z} [0,0,0]	(11) $\bar{x}+y,y,\bar{z}$ [0,0,0]	(12) x,x-y, \bar{z} [0,0,0]
	(13) \bar{x},\bar{y},\bar{z} [0,0,0]	(14) $y,\bar{x}+y,\bar{z}$ [0,0,0]	(15) x-y,x, \bar{z} [0,0,0]
	(16) x,y, \bar{z} [0,0,0]	(17) $\bar{y},x-y,\bar{z}$ [0,0,0]	(18) $\bar{x}+y,\bar{x},\bar{z}$ [0,0,0]
	(19) \bar{y},\bar{x},z [0,0,0]	(20) $\bar{x}+y,y,z$ [0,0,0]	(21) x,x-y,z [0,0,0]
	(22) y,x,z [0,0,0]	(23) x-y, \bar{y},z [0,0,0]	(24) $\bar{x},\bar{x}+y,z$ [0,0,0]
12 k m..1'	x,y,1/2 [0,0,0]	$\bar{y},x-y,1/2$ [0,0,0]	$\bar{x}+y,\bar{x},1/2$ [0,0,0]
	$\bar{x},\bar{y},1/2$ [0,0,0]	$y,\bar{x}+y,1/2$ [0,0,0]	x-y,x,1/2 [0,0,0]
	y,x,1/2 [0,0,0]	x-y, $\bar{y},1/2$ [0,0,0]	$\bar{x},\bar{x}+y,1/2$ [0,0,0]
	$\bar{y},\bar{x},1/2$ [0,0,0]	$\bar{x}+y,y,1/2$ [0,0,0]	x,x-y,1/2 [0,0,0]
12 j m..1'	x,y,0 [0,0,0]	$\bar{y},x-y,0$ [0,0,0]	$\bar{x}+y,\bar{x},0$ [0,0,0]
	$\bar{x},\bar{y},0$ [0,0,0]	$y,\bar{x}+y,0$ [0,0,0]	x-y,x,0 [0,0,0]
	y,x,0 [0,0,0]	x-y, $\bar{y},0$ [0,0,0]	$\bar{x},\bar{x}+y,0$ [0,0,0]
	$\bar{y},\bar{x},0$ [0,0,0]	$\bar{x}+y,y,0$ [0,0,0]	x,x-y,0 [0,0,0]

Continued		No. 73.2.370	<i>p6/mmm1'</i>
12 i .m.1'	x,2x,z [0,0,0]	2 \bar{x} , \bar{x} ,z [0,0,0]	x, \bar{x} ,z [0,0,0]
	\bar{x} ,2 \bar{x} ,z [0,0,0]	2x,x,z [0,0,0]	\bar{x} ,x,z [0,0,0]
	2x,x, \bar{z} [0,0,0]	\bar{x} ,2 \bar{x} , \bar{z} [0,0,0]	\bar{x} ,x, \bar{z} [0,0,0]
	2 \bar{x} , \bar{x} , \bar{z} [0,0,0]	x,2x, \bar{z} [0,0,0]	x, \bar{x} , \bar{z} [0,0,0]
12 h ..m1'	x,0,z [0,0,0]	0,x,z [0,0,0]	\bar{x} , \bar{x} ,z [0,0,0]
	\bar{x} ,0,z [0,0,0]	0, \bar{x} ,z [0,0,0]	x,x,z [0,0,0]
	0,x, \bar{z} [0,0,0]	x,0, \bar{z} [0,0,0]	\bar{x} , \bar{x} , \bar{z} [0,0,0]
	0, \bar{x} , \bar{z} [0,0,0]	\bar{x} ,0, \bar{z} [0,0,0]	x,x, \bar{z} [0,0,0]
6 g mm21'	x,2x,1/2 [0,0,0]	2 \bar{x} , \bar{x} ,1/2 [0,0,0]	x, \bar{x} ,1/2 [0,0,0]
	\bar{x} ,2 \bar{x} ,1/2 [0,0,0]	2x,x,1/2 [0,0,0]	\bar{x} ,x,1/2 [0,0,0]
6 f mm21'	x,2x,0 [0,0,0]	2 \bar{x} , \bar{x} ,0 [0,0,0]	x, \bar{x} ,0 [0,0,0]
	\bar{x} ,2 \bar{x} ,0 [0,0,0]	2x,x,0 [0,0,0]	\bar{x} ,x,0 [0,0,0]
6 e m2m1'	x,0,1/2 [0,0,0]	0,x,1/2 [0,0,0]	\bar{x} , \bar{x} ,1/2 [0,0,0]
	\bar{x} ,0,1/2 [0,0,0]	0, \bar{x} ,1/2 [0,0,0]	x,x,1/2 [0,0,0]
6 d m2m1'	x,0,0 [0,0,0]	0,x,0 [0,0,0]	\bar{x} , \bar{x} ,0 [0,0,0]
	\bar{x} ,0,0 [0,0,0]	0, \bar{x} ,0 [0,0,0]	x,x,0 [0,0,0]
2 c 6mm1'	0,0,z [0,0,0]	0,0, \bar{z} [0,0,0]	
1 b 6/mmm1'	0,0,1/2 [0,0,0]		
1 a 6/mmm1'	0,0,0 [0,0,0]		

Continued

No. 73.2.370

p6/mmm1'

Symmetry of special projections

Along [001] $6mm1'$

Origin at 0,0,z

Along [100] $p2mm1'$

$a^* = c$

Origin at x,0,0

Along [210] $p2mm1'$

$a^* = c$

Origin at x,x/2,0

$p6/m'm'm'$

$6/m'm'm'$

Hexagonal

No. 73.3.371

$p6/m'2/m'2/m'$

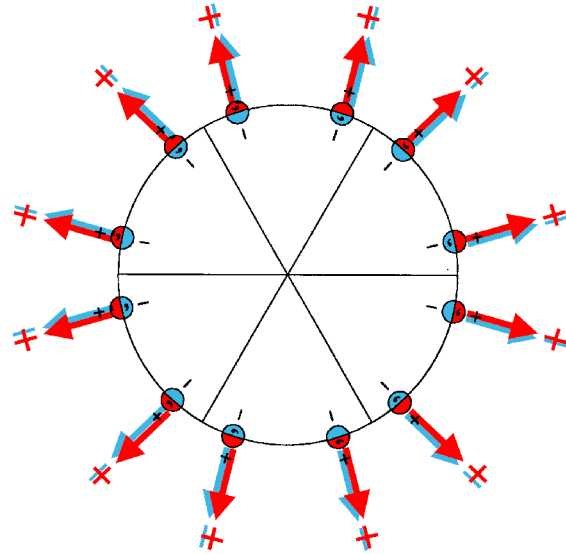
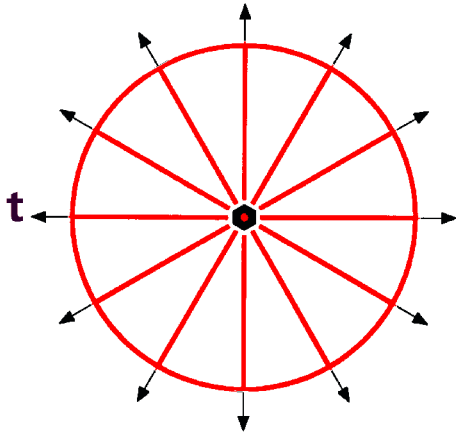

Origin at center ($6/m'm'm'$)

Asymmetric unit $0 \leq x$; $0 \leq y$; $0 \leq z \leq 1/2$; $y \leq x/2$

Symmetry operations

- | | | |
|--|--|--|
| (1) 1
(1 0,0,0) | (2) 3^+ 0,0,z
(3_z 0,0,0) | (3) 3^- 0,0,z
(3_z^{-1} 0,0,0) |
| (4) 2 0,0,z
(2_z 0,0,0) | (5) 6^- 0,0,z
(6_z^{-1} 0,0,0) | (6) 6^+ 0,0,z
(6_z 0,0,0) |
| (7) 2 x,x,0
(2_{xy} 0,0,0) | (8) 2 x,0,0
(2_x 0,0,0) | (9) 2 0,y,0
(2_y 0,0,0) |
| (10) 2 x, \bar{x} ,0
(2_3 0,0,0) | (11) 2 x,2x,0
(2_2 0,0,0) | (12) 2 2x,x,0
(2_1 0,0,0) |
| (13) $\bar{1}$ 0,0,0
($\bar{1}$ 0,0,0)' | (14) $\bar{3}^+$ 0,0,z; 0,0,0
($\bar{3}_z$ 0,0,0)' | (15) $\bar{3}^-$ 0,0,z; 0,0,0
($\bar{3}_z^{-1}$ 0,0,0)' |
| (16) m' x,y,0
(m_z 0,0,0)' | (17) $\bar{6}^-$ 0,0,z; 0,0,0
($\bar{6}_z^{-1}$ 0,0,0)' | (18) $\bar{6}^+$ 0,0,z; 0,0,0
($\bar{6}_z$ 0,0,0)' |
| (19) m' x, \bar{x} ,z
(m_{xy} 0,0,0)' | (20) m' x,2x,z
(m_x 0,0,0)' | (21) m' 2x,x,z
(m_y 0,0,0)' |
| (22) m' x,x,z
(m_3 0,0,0)' | (23) m' x,0,z
(m_2 0,0,0)' | (24) m' 0,y,z
(m_1 0,0,0)' |

Generators selected (1); t(0,0,1); (2); (4); (7); (13)

Positions

	Coordinates		
Multiplicity, Wyckoff letter, Site symmetry			
24 l 1	(1) x,y,z [u,v,w]	(2) $\bar{y},x-y,z$ [$\bar{v},u-v,w$]	(3) $\bar{x}+y,\bar{x},z$ [$\bar{u}+v,\bar{u},w$]
	(4) \bar{x},\bar{y},z [\bar{u},\bar{v},w]	(5) $y,\bar{x}+y,z$ [$v,\bar{u}+v,w$]	(6) x-y,x,z [u-v,u,w]
	(7) y,x, \bar{z} [v,u, \bar{w}]	(8) x-y, \bar{y},\bar{z} [u-v, \bar{v},\bar{w}]	(9) $\bar{x},\bar{x}+y,\bar{z}$ [$\bar{u},\bar{u}+v,\bar{w}$]
	(10) \bar{y},\bar{x},\bar{z} [\bar{v},\bar{u},\bar{w}]	(11) $\bar{x}+y,y,\bar{z}$ [$\bar{u}+v,v,\bar{w}$]	(12) x,x-y, \bar{z} [u,u-v, \bar{w}]
	(13) \bar{x},\bar{y},\bar{z} [\bar{u},\bar{v},\bar{w}]	(14) $y,\bar{x}+y,\bar{z}$ [$v,\bar{u}+v,\bar{w}$]	(15) x-y,x, \bar{z} [u-v,u, \bar{w}]
	(16) x,y, \bar{z} [u,v, \bar{w}]	(17) $\bar{y},x-y,\bar{z}$ [$\bar{v},u-v,\bar{w}$]	(18) $\bar{x}+y,\bar{x},\bar{z}$ [$\bar{u}+v,\bar{u},\bar{w}$]
	(19) \bar{y},\bar{x},z [\bar{v},\bar{u},w]	(20) $\bar{x}+y,y,z$ [$\bar{u}+v,v,w$]	(21) x,x-y,z [u,u-v,w]
	(22) y,x,z [v,u,w]	(23) x-y, \bar{y},z [u-v, \bar{v},w]	(24) $\bar{x},\bar{x}+y,z$ [$\bar{u},\bar{u}+v,w$]
12 k m'..	x,y,1/2 [u,v,0]	$\bar{y},x-y,1/2$ [$\bar{v},u-v,0$]	$\bar{x}+y,\bar{x},1/2$ [$\bar{u}+v,\bar{u},0$]
	$\bar{x},\bar{y},1/2$ [$\bar{u},\bar{v},0$]	$y,\bar{x}+y,1/2$ [$v,\bar{u}+v,0$]	x-y,x,1/2 [u-v,v,0]
	y,x,1/2 [v,u,0]	x-y, $\bar{y},1/2$ [u-v, $\bar{v},0$]	$\bar{x},\bar{x}+y,1/2$ [$\bar{u},\bar{u}+v,0$]
	$\bar{y},\bar{x},1/2$ [$\bar{v},\bar{u},0$]	$\bar{x}+y,y,1/2$ [$\bar{u}+v,v,0$]	x,x-y,1/2 [u,u-v,0]
12 j m'..	x,y,0 [u,v,0]	$\bar{y},x-y,0$ [$\bar{v},u-v,0$]	$\bar{x}+y,\bar{x},0$ [$\bar{u}+v,\bar{u},0$]
	$\bar{x},\bar{y},0$ [$\bar{u},\bar{v},0$]	$y,\bar{x}+y,0$ [$v,\bar{u}+v,0$]	x-y,x,0 [u-v,v,0]
	y,x,0 [v,u,0]	x-y, $\bar{y},0$ [u-v, $\bar{v},0$]	$\bar{x},\bar{x}+y,0$ [$\bar{u},\bar{u}+v,0$]
	$\bar{y},\bar{x},0$ [$\bar{v},\bar{u},0$]	$\bar{x}+y,y,0$ [$\bar{u}+v,v,0$]	x,x-y,0 [u,u-v,0]

Continued

No. 73.3.371

p6/m'm'm'

12 i .m'	x,2x,z [u,2u,w]	2 \bar{x} , \bar{x} ,z [2 \bar{u} , \bar{u} ,w]	x, \bar{x} ,z [u, \bar{u} ,w]
	\bar{x} ,2 \bar{x} ,z [\bar{u} ,2 \bar{u} ,w]	2x,x,z [2u,u,w]	\bar{x} ,x,z [\bar{u} ,u,w]
	2x,x, \bar{z} [2u,u, \bar{w}]	\bar{x} ,2 \bar{x} , \bar{z} [\bar{u} ,2 \bar{u} , \bar{w}]	\bar{x} ,x, \bar{z} [\bar{u} ,u, \bar{w}]
	2 \bar{x} , \bar{x} , \bar{z} [2 \bar{u} , \bar{u} , \bar{w}]	x,2x, \bar{z} [u,2u, \bar{w}]	x, \bar{x} , \bar{z} [u, \bar{u} , \bar{w}]
12 h ..m'	x,0,z [u,0,w]	0,x,z [0,u,w]	\bar{x} , \bar{x} ,z [\bar{u} , \bar{u} ,w]
	\bar{x} ,0,z [\bar{u} ,0,w]	0, \bar{x} ,z [0, \bar{u} ,w]	x,x,z [u,u,w]
	0,x, \bar{z} [0,u, \bar{w}]	x,0, \bar{z} [u,0, \bar{w}]	\bar{x} , \bar{x} , \bar{z} [\bar{u} , \bar{u} , \bar{w}]
	0, \bar{x} , \bar{z} [0, \bar{u} , \bar{w}]	\bar{x} ,0, \bar{z} [\bar{u} ,0, \bar{w}]	x,x, \bar{z} [u,u, \bar{w}]
6 g m'm'2	x,2x,1/2 [u,2u,0]	2 \bar{x} , \bar{x} ,1/2 [2 \bar{u} , \bar{u} ,0]	x, \bar{x} ,1/2 [u, \bar{u} ,0]
	\bar{x} ,2 \bar{x} ,1/2 [\bar{u} ,2 \bar{u} ,0]	2x,x,1/2 [2u,u,0]	\bar{x} ,x,1/2 [\bar{u} ,u,0]
6 f m'm'2	x,2x,0 [u,2u,0]	2 \bar{x} , \bar{x} ,0 [2 \bar{u} , \bar{u} ,0]	x, \bar{x} ,0 [u, \bar{u} ,0]
	\bar{x} ,2 \bar{x} ,0 [\bar{u} ,2 \bar{u} ,0]	2x,x,0 [2u,u,0]	\bar{x} ,x,0 [\bar{u} ,u,0]
6 e m'2m'	x,0,1/2 [u,0,0]	0,x,1/2 [0,u,0]	\bar{x} , \bar{x} ,1/2 [\bar{u} , \bar{u} ,0]
	\bar{x} ,0,1/2 [\bar{u} ,0,0]	0, \bar{x} ,1/2 [0, \bar{u} ,0]	x,x,1/2 [u,u,0]
6 d m'2m'	x,0,0 [u,0,0]	0,x,0 [0,u,0]	\bar{x} , \bar{x} ,0 [\bar{u} , \bar{u} ,0]
	\bar{x} ,0,0 [\bar{u} ,0,0]	0, \bar{x} ,0 [0, \bar{u} ,0]	x,x,0 [u,u,0]
2 c 6m'm'	0,0,z [0,0,w]	0,0, \bar{z} [0,0, \bar{w}]	
1 b 6/m'm'm'	0,0,1/2 [0,0,0]		
1 a 6/m'm'm'	0,0,0 [0,0,0]		

Continued

No. 73.3.371

$p6/m'm'm'$

Symmetry of special projections

Along [001] $6mm1'$

Origin at 0,0,z

Along [100] $p2m'm'$

$a^* = c$

Origin at x,0,0

Along [210] $p2m'm'$

$a^* = c$

Origin at x,x/2,0

$p6/mm'm'$

$6/mm'm'$

Hexagonal

No. 73.4.372

$p6/m2'/m'2'/m'$

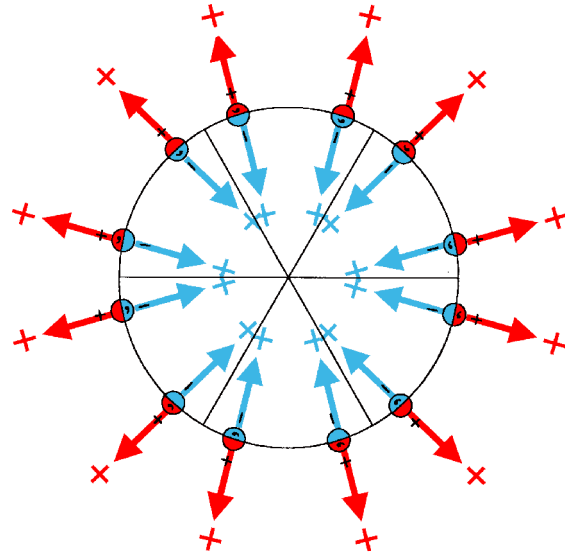
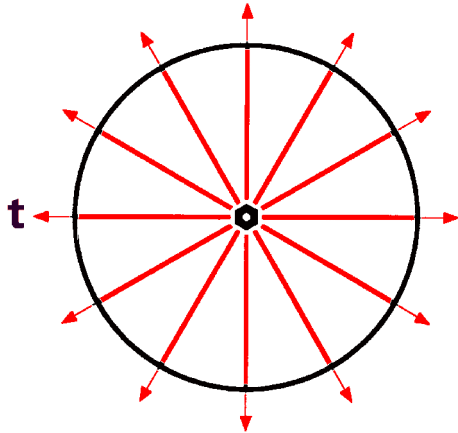

Origin at center ($6/mm'm'$)

Asymmetric unit $0 \leq x; 0 \leq y; 0 \leq z \leq 1/2; y \leq x/2$

Symmetry operations

- | | | |
|--|---|---|
| (1) 1
(1 0,0,0) | (2) 3^+ 0,0,z
(3_z 0,0,0) | (3) 3^- 0,0,z
(3_z^{-1} 0,0,0) |
| (4) 2 0,0,z
(2_z 0,0,0) | (5) 6^- 0,0,z
(6_z^{-1} 0,0,0) | (6) 6^+ 0,0,z
(6_z 0,0,0) |
| (7) $2'$ x,x,0
(2_{xy} 0,0,0)' | (8) $2'$ x,0,0
(2_x 0,0,0)' | (9) $2'$ 0,y,0
(2_y 0,0,0)' |
| (10) $2'$ x, \bar{x} ,0
(2_3 0,0,0)' | (11) $2'$ x,2x,0
(2_2 0,0,0)' | (12) $2'$ 2x,x,0
(2_1 0,0,0)' |
| (13) $\bar{1}$ 0,0,0
($\bar{1}$ 0,0,0) | (14) $\bar{3}^+$ 0,0,z; 0,0,0
($\bar{3}_z$ 0,0,0) | (15) $\bar{3}^-$ 0,0,z; 0,0,0
($\bar{3}_z^{-1}$ 0,0,0) |
| (16) m x,y,0
(m_z 0,0,0) | (17) $\bar{6}^-$ 0,0,z; 0,0,0
($\bar{6}_z^{-1}$ 0,0,0) | (18) $\bar{6}^+$ 0,0,z; 0,0,0
($\bar{6}_z$ 0,0,0) |
| (19) m' x, \bar{x} ,z
(m_{xy} 0,0,0)' | (20) m' x,2x,z
(m_x 0,0,0)' | (21) m' 2x,x,z
(m_y 0,0,0)' |
| (22) m' x,x,z
(m_3 0,0,0)' | (23) m' x,0,z
(m_2 0,0,0)' | (24) m' 0,y,z
(m_1 0,0,0)' |

Generators selected (1); t(0,0,1); (2); (4); (7); (13)

Positions

	Coordinates		
Multiplicity, Wyckoff letter, Site symmetry			
24 l 1	(1) x,y,z [u,v,w]	(2) $\bar{y},x-y,z$ [$\bar{v},u-v,w$]	(3) $\bar{x}+y,\bar{x},z$ [$\bar{u}+v,\bar{u},w$]
	(4) \bar{x},\bar{y},z [\bar{u},\bar{v},w]	(5) $y,\bar{x}+y,z$ [$v,\bar{u}+v,w$]	(6) x-y,x,z [u-v,u,w]
	(7) y,x, \bar{z} [\bar{v},\bar{u},w]	(8) x-y, \bar{y},\bar{z} [$\bar{u}+v,v,w$]	(9) $\bar{x},\bar{x}+y,\bar{z}$ [u,u-v,w]
	(10) \bar{y},\bar{x},\bar{z} [v,u,w]	(11) $\bar{x}+y,y,\bar{z}$ [u-v, \bar{v},w]	(12) x,x-y, \bar{z} [$\bar{u},\bar{u}+v,w$]
	(13) \bar{x},\bar{y},\bar{z} [u,v,w]	(14) $y,\bar{x}+y,\bar{z}$ [$\bar{v},u-v,w$]	(15) x-y,x, \bar{z} [$\bar{u}+v,\bar{u},w$]
	(16) x,y, \bar{z} [\bar{u},\bar{v},w]	(17) $\bar{y},x-y,\bar{z}$ [v, $\bar{u}+v,w$]	(18) $\bar{x}+y,\bar{x},\bar{z}$ [u-v,u,w]
	(19) \bar{y},\bar{x},z [\bar{v},\bar{u},w]	(20) $\bar{x}+y,y,z$ [$\bar{u}+v,v,w$]	(21) x,x-y,z [u,u-v,w]
	(22) y,x,z [v,u,w]	(23) x-y, \bar{y},z [u-v, \bar{v},w]	(24) $\bar{x},\bar{x}+y,z$ [$\bar{u},\bar{u}+v,w$]
12 k m..	x,y,1/2 [0,0,w]	$\bar{y},x-y,1/2$ [0,0,w]	$\bar{x}+y,\bar{x},1/2$ [0,0,w]
	$\bar{x},\bar{y},1/2$ [0,0,w]	y, $\bar{x}+y,1/2$ [0,0,w]	x-y,x,1/2 [0,0,w]
	y,x,1/2 [0,0,w]	x-y, $\bar{y},1/2$ [0,0,w]	$\bar{x},\bar{x}+y,1/2$ [0,0,w]
	$\bar{y},\bar{x},1/2$ [0,0,w]	$\bar{x}+y,y,1/2$ [0,0,w]	x,x-y,1/2 [0,0,w]
12 j m..	x,y,0 [0,0,w]	$\bar{y},x-y,0$ [0,0,w]	$\bar{x}+y,\bar{x},0$ [0,0,w]
	$\bar{x},\bar{y},0$ [0,0,w]	y, $\bar{x}+y,0$ [0,0,w]	x-y,x,0 [0,0,w]
	y,x,0 [0,0,w]	x-y, $\bar{y},0$ [0,0,w]	$\bar{x},\bar{x}+y,0$ [0,0,w]
	$\bar{y},\bar{x},0$ [0,0,w]	$\bar{x}+y,y,0$ [0,0,w]	x,x-y,0 [0,0,w]

Continued		No. 73.4.372	$\rho_6/mm'm'$
12 i .m'	$x,2x,z [u,2u,w]$	$2\bar{x},\bar{x},z [2\bar{u},\bar{u},w]$	$x,\bar{x},z [u,\bar{u},w]$
	$\bar{x},2\bar{x},z [\bar{u},2\bar{u},w]$	$2x,x,z [2u,u,w]$	$\bar{x},x,z [\bar{u},u,w]$
	$2x,x,\bar{z} [2\bar{u},\bar{u},w]$	$\bar{x},2\bar{x},\bar{z} [u,2u,w]$	$\bar{x},x,\bar{z} [u,\bar{u},w]$
	$2\bar{x},\bar{x},\bar{z} [2u,u,w]$	$x,2x,\bar{z} [\bar{u},2\bar{u},w]$	$x,\bar{x},\bar{z} [\bar{u},u,w]$
12 h ..m'	$x,0,z [u,0,w]$	$0,x,z [0,u,w]$	$\bar{x},\bar{x},z [\bar{u},\bar{u},w]$
	$\bar{x},0,z [\bar{u},0,w]$	$0,\bar{x},z [0,\bar{u},w]$	$x,x,z [u,u,w]$
	$0,x,\bar{z} [0,\bar{u},w]$	$x,0,\bar{z} [\bar{u},0,w]$	$\bar{x},\bar{x},\bar{z} [u,u,w]$
	$0,\bar{x},\bar{z} [0,u,w]$	$\bar{x},0,\bar{z} [u,0,w]$	$x,x,\bar{z} [\bar{u},\bar{u},w]$
6 g mm'2'	$x,2x,1/2 [0,0,w]$	$2\bar{x},\bar{x},1/2 [0,0,w]$	$x,\bar{x},1/2 [0,0,w]$
	$\bar{x},2\bar{x},1/2 [0,0,w]$	$2x,x,1/2 [0,0,w]$	$\bar{x},x,1/2 [0,0,w]$
6 f mm'2'	$x,2x,0 [0,0,w]$	$2\bar{x},\bar{x},0 [0,0,w]$	$x,\bar{x},0 [0,0,w]$
	$\bar{x},2\bar{x},0 [0,0,w]$	$2x,x,0 [0,0,w]$	$\bar{x},x,0 [0,0,w]$
6 e m2'm'	$x,0,1/2 [0,0,w]$	$0,x,1/2 [0,0,w]$	$\bar{x},\bar{x},1/2 [0,0,w]$
	$\bar{x},0,1/2 [0,0,w]$	$0,\bar{x},1/2 [0,0,w]$	$x,x,1/2 [0,0,w]$
6 d m2'm'	$x,0,0 [0,0,w]$	$0,x,0 [0,0,w]$	$\bar{x},\bar{x},0 [0,0,w]$
	$\bar{x},0,0 [0,0,w]$	$0,\bar{x},0 [0,0,w]$	$x,x,0 [0,0,w]$
2 c 6m'm'	$0,0,z [0,0,w]$	$0,0,\bar{z} [0,0,w]$	
1 b 6/mm'm'	$0,0,1/2 [0,0,w]$		
1 a 6/mm'm'	$0,0,0 [0,0,w]$		

Continued

No. 73.4.372

$p6/mm'm'$

Symmetry of special projections

Along $[001]$ $6m'm'$

Origin at $0,0,z$

Along $[100]$ $p2'mm'$

$a^* = c$

Origin at $x,0,0$

Along $[210]$ $p2'mm'$

$a^* = c$

Origin at $x,x/2,0$

$p6/m'mm$

$6/m'mm$

Hexagonal

No. 73.5.373

$p6/m'2/m2'/m$

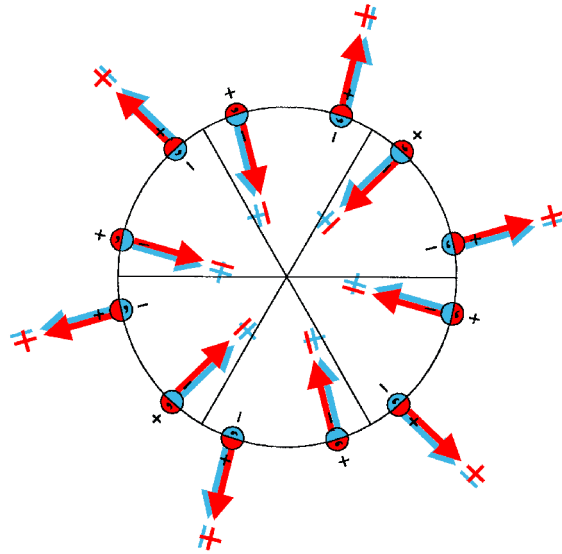
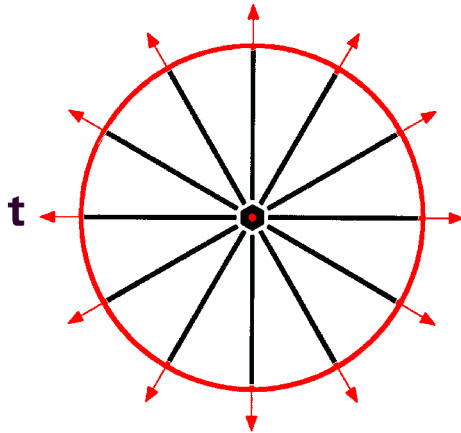

Origin at center ($6/m'mm$)

Asymmetric unit $0 \leq x; 0 \leq y; 0 \leq z \leq 1/2; y \leq x/2$

Symmetry operations

- | | | |
|---|--|--|
| (1) 1
(1 0,0,0) | (2) 3^+ 0,0,z
(3_z 0,0,0) | (3) 3^- 0,0,z
(3_z^{-1} 0,0,0) |
| (4) 2 0,0,z
(2_z 0,0,0) | (5) 6^- 0,0,z
(6_z^{-1} 0,0,0) | (6) 6^+ 0,0,z
(6_z 0,0,0) |
| (7) $2'$ x,x,0
(2_{xy} 0,0,0)' | (8) $2'$ x,0,0
(2_x 0,0,0)' | (9) $2'$ 0,y,0
(2_y 0,0,0)' |
| (10) $2'$ x, \bar{x} ,0
(2_3 0,0,0)' | (11) $2'$ x,2x,0
(2_2 0,0,0)' | (12) $2'$ 2x,x,0
(2_1 0,0,0)' |
| (13) $\bar{1}$ 0,0,0
($\bar{1}$ 0,0,0)' | (14) $\bar{3}^+$ 0,0,z; 0,0,0
($\bar{3}_z$ 0,0,0)' | (15) $\bar{3}^-$ 0,0,z; 0,0,0
($\bar{3}_z^{-1}$ 0,0,0)' |
| (16) m' x,y,0
(m_z 0,0,0)' | (17) $\bar{6}^-$ 0,0,z; 0,0,0
($\bar{6}_z^{-1}$ 0,0,0)' | (18) $\bar{6}^+$ 0,0,z; 0,0,0
($\bar{6}_z$ 0,0,0)' |
| (19) m x, \bar{x} ,z
(m_{xy} 0,0,0) | (20) m x,2x,z
(m_x 0,0,0) | (21) m 2x,x,z
(m_y 0,0,0) |
| (22) m x,x,z
(m_3 0,0,0) | (23) m x,0,z
(m_2 0,0,0) | (24) m 0,y,z
(m_1 0,0,0) |

Generators selected (1); t(0,0,1); (2); (4); (7); (13)

Positions

	Coordinates		
Multiplicity, Wyckoff letter, Site symmetry			
24 l 1	(1) x,y,z [u,v,w]	(2) $\bar{y},x-y,z$ [$\bar{v},u-v,w$]	(3) $\bar{x}+y,\bar{x},z$ [$\bar{u}+v,\bar{u},w$]
	(4) \bar{x},\bar{y},z [\bar{u},\bar{v},w]	(5) $y,\bar{x}+y,z$ [$v,\bar{u}+v,w$]	(6) x-y,x,z [u-v,u,w]
	(7) y,x, \bar{z} [\bar{v},\bar{u},w]	(8) x-y, \bar{y},\bar{z} [$\bar{u}+v,v,w$]	(9) $\bar{x},\bar{x}+y,\bar{z}$ [u,u-v,w]
	(10) \bar{y},\bar{x},\bar{z} [v,u,w]	(11) $\bar{x}+y,y,\bar{z}$ [u-v, \bar{v},w]	(12) x,x-y, \bar{z} [$\bar{u},\bar{u}+v,w$]
	(13) \bar{x},\bar{y},\bar{z} [\bar{u},\bar{v},\bar{w}]	(14) $y,\bar{x}+y,\bar{z}$ [$v,\bar{u}+v,\bar{w}$]	(15) x-y,x, \bar{z} [u-v,u, \bar{w}]
	(16) x,y, \bar{z} [u,v, \bar{w}]	(17) $\bar{y},x-y,\bar{z}$ [$\bar{v},u-v,\bar{w}$]	(18) $\bar{x}+y,\bar{x},\bar{z}$ [$\bar{u}+v,\bar{u},\bar{w}$]
	(19) \bar{y},\bar{x},z [v,u, \bar{w}]	(20) $\bar{x}+y,y,z$ [u-v, \bar{v},\bar{w}]	(21) x,x-y,z [$\bar{u},\bar{u}+v,\bar{w}$]
	(22) y,x,z [\bar{v},\bar{u},\bar{w}]	(23) x-y, \bar{y},z [$\bar{u}+v,v,\bar{w}$]	(24) $\bar{x},\bar{x}+y,z$ [u,u-v, \bar{w}]
12 k m'..	x,y,1/2 [u,v,0]	$\bar{y},x-y,1/2$ [$\bar{v},u-v,0$]	$\bar{x}+y,\bar{x},1/2$ [$\bar{u}+v,\bar{u},0$]
	$\bar{x},\bar{y},1/2$ [$\bar{u},\bar{v},0$]	$y,\bar{x}+y,1/2$ [v, $\bar{u}+v,0$]	x-y,x,1/2 [u-v,u,0]
	y,x,1/2 [$\bar{v},\bar{u},0$]	x-y, $\bar{y},1/2$ [$\bar{u}+v,v,0$]	$\bar{x},\bar{x}+y,1/2$ [u,u-v,0]
	$\bar{y},\bar{x},1/2$ [v,u,0]	$\bar{x}+y,y,1/2$ [u-v, $\bar{v},0$]	x,x-y,1/2 [$\bar{u},\bar{u}+v,0$]
12 j m'..	x,y,0 [u,v,0]	$\bar{y},x-y,0$ [$\bar{v},u-v,0$]	$\bar{x}+y,\bar{x},0$ [$\bar{u}+v,\bar{u},0$]
	$\bar{x},\bar{y},0$ [$\bar{u},\bar{v},0$]	$y,\bar{x}+y,0$ [v, $\bar{u}+v,0$]	x-y,x,0 [u-v,u,0]
	y,x,0 [$\bar{v},\bar{u},0$]	x-y, $\bar{y},0$ [$\bar{u}+v,v,0$]	$\bar{x},\bar{x}+y,0$ [u,u-v,0]
	$\bar{y},\bar{x},0$ [v,u,0]	$\bar{x}+y,y,0$ [u-v, $\bar{v},0$]	x,x-y,0 [$\bar{u},\bar{u}+v,0$]

Continued

No. 73.5.373

 $p6/m'mm$

12 i .m.	$x, 2x, z [u, 0, 0]$	$2\bar{x}, \bar{x}, z [0, u, 0]$	$x, \bar{x}, z [\bar{u}, \bar{u}, 0]$
	$\bar{x}, 2\bar{x}, z [\bar{u}, 0, 0]$	$2x, x, z [0, \bar{u}, 0]$	$\bar{x}, x, z [u, u, 0]$
	$2x, x, \bar{z} [0, \bar{u}, 0]$	$\bar{x}, 2\bar{x}, \bar{z} [\bar{u}, 0, 0]$	$\bar{x}, x, \bar{z} [u, u, 0]$
	$2\bar{x}, \bar{x}, \bar{z} [0, u, 0]$	$x, 2x, \bar{z} [u, 0, 0]$	$x, \bar{x}, \bar{z} [\bar{u}, \bar{u}, 0]$
12 h ..m	$x, 0, z [u, 2u, 0]$	$0, x, z [2\bar{u}, \bar{u}, 0]$	$\bar{x}, \bar{x}, z [u, \bar{u}, 0]$
	$\bar{x}, 0, z [\bar{u}, 2\bar{u}, 0]$	$0, \bar{x}, z [2u, u, 0]$	$x, x, z [\bar{u}, u, 0]$
	$0, x, \bar{z} [2\bar{u}, \bar{u}, 0]$	$x, 0, \bar{z} [u, 2u, 0]$	$\bar{x}, \bar{x}, \bar{z} [u, \bar{u}, 0]$
	$0, \bar{x}, \bar{z} [2u, u, 0]$	$\bar{x}, 0, \bar{z} [\bar{u}, 2\bar{u}, 0]$	$x, x, \bar{z} [\bar{u}, u, 0]$
6 g m'm2'	$x, 2x, 1/2 [u, 0, 0]$	$2\bar{x}, \bar{x}, 1/2 [0, u, 0]$	$x, \bar{x}, 1/2 [\bar{u}, \bar{u}, 0]$
	$\bar{x}, 2\bar{x}, 1/2 [\bar{u}, 0, 0]$	$2x, x, 1/2 [0, \bar{u}, 0]$	$\bar{x}, x, 1/2 [u, u, 0]$
6 f m'm2'	$x, 2x, 0 [u, 0, 0]$	$2\bar{x}, \bar{x}, 0 [0, u, 0]$	$x, \bar{x}, 0 [\bar{u}, \bar{u}, 0]$
	$\bar{x}, 2\bar{x}, 0 [\bar{u}, 0, 0]$	$2x, x, 0 [0, \bar{u}, 0]$	$\bar{x}, x, 0 [u, u, 0]$
6 e m'2'm	$x, 0, 1/2 [u, 2u, 0]$	$0, x, 1/2 [2\bar{u}, \bar{u}, 0]$	$\bar{x}, \bar{x}, 1/2 [u, \bar{u}, 0]$
	$\bar{x}, 0, 1/2 [\bar{u}, 2\bar{u}, 0]$	$0, \bar{x}, 1/2 [2u, u, 0]$	$x, x, 1/2 [\bar{u}, u, 0]$
6 d m'2'm	$x, 0, 0 [u, 2u, 0]$	$0, x, 0 [2\bar{u}, \bar{u}, 0]$	$\bar{x}, \bar{x}, 0 [u, \bar{u}, 0]$
	$\bar{x}, 0, 0 [\bar{u}, 2\bar{u}, 0]$	$0, \bar{x}, 0 [2u, u, 0]$	$x, x, 0 [\bar{u}, u, 0]$
2 c 6mm	$0, 0, z [0, 0, 0]$	$0, 0, \bar{z} [0, 0, 0]$	
1 b 6/m'mm	$0, 0, 1/2 [0, 0, 0]$		
1 a 6/m'mm	$0, 0, 0 [0, 0, 0]$		

Continued

No. 73.5.373

$p6/m'mm$

Symmetry of special projections

Along $[001]$ $6mm1'$

Origin at $0,0,z$

Along $[100]$ $p2mm1'$

$a^* = c$

Origin at $x,0,0$

Along $[210]$ $p2mm1'$

$a^* = c$

Origin at $x,x/2,0$

$p6'/m'm'm$

$6'/m'm'm$

Hexagonal

No. 73.6.374

$p6'/m'2'/m'2'/m$

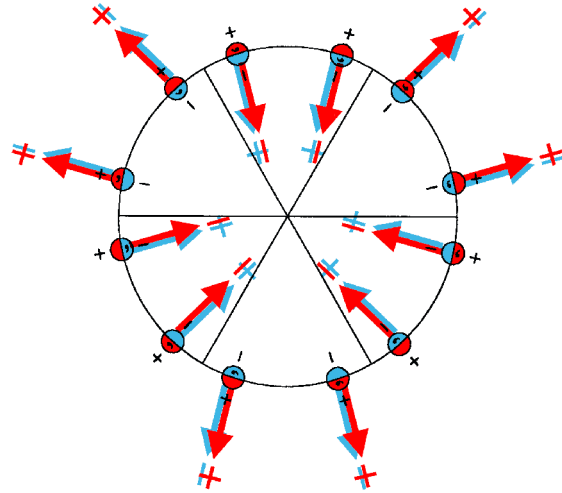
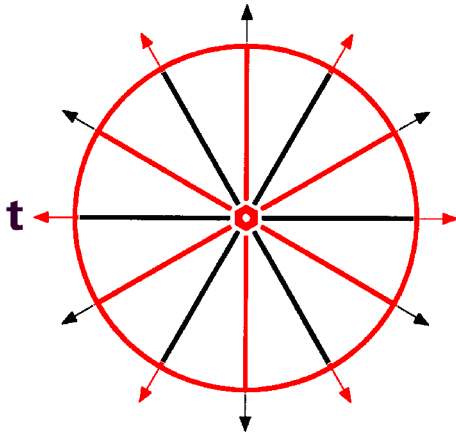

Origin at center ($6'/m'm'm$)

Asymmetric unit $0 \leq x$; $0 \leq y$; $0 \leq z \leq 1/2$; $y \leq x/2$

Symmetry operations

- | | | |
|--|--|---|
| (1) 1
(1 0,0,0) | (2) 3^+ 0,0,z
(3_z 0,0,0) | (3) 3^- 0,0,z
(3_z^{-1} 0,0,0) |
| (4) $2'$ 0,0,z
(2_z 0,0,0)' | (5) 6^- 0,0,z
(6_z^{-1} 0,0,0)' | (6) 6^+ 0,0,z
(6_z 0,0,0)' |
| (7) $2'$ x,x,0
(2_{xy} 0,0,0)' | (8) $2'$ x,0,0
(2_x 0,0,0)' | (9) $2'$ 0,y,0
(2_y 0,0,0)' |
| (10) 2 x, \bar{x} ,0
(2_3 0,0,0) | (11) 2 x,2x,0
(2_2 0,0,0) | (12) 2 2x,x,0
(2_1 0,0,0) |
| (13) $\bar{1}$ 0,0,0
($\bar{1}$ 0,0,0) | (14) $\bar{3}^+$ 0,0,z; 0,0,0
($\bar{3}_z$ 0,0,0) | (15) $\bar{3}^-$ 0,0,z; 0,0,0
($\bar{3}_z^{-1}$ 0,0,0) |
| (16) m' x,y,0
(m_z 0,0,0)' | (17) $\bar{6}^-$ 0,0,z; 0,0,0
($\bar{6}_z^{-1}$ 0,0,0)' | (18) $\bar{6}^+$ 0,0,z; 0,0,0
($\bar{6}_z$ 0,0,0)' |
| (19) m' x, \bar{x} ,z
(m_{xy} 0,0,0)' | (20) m' x,2x,z
(m_x 0,0,0)' | (21) m' 2x,x,z
(m_y 0,0,0)' |
| (22) m x,x,z
(m_3 0,0,0) | (23) m x,0,z
(m_2 0,0,0) | (24) m 0,y,z
(m_1 0,0,0) |

Generators selected (1); t(0,0,1); (2); (4); (7); (13)

Positions

	Coordinates		
Multiplicity, Wyckoff letter, Site symmetry			
24 l 1	(1) x,y,z [u,v,w]	(2) $\bar{y},x-y,z$ [$\bar{v},u-v,w$]	(3) $\bar{x}+y,\bar{x},z$ [$\bar{u}+v,\bar{u},w$]
	(4) \bar{x},\bar{y},z [u,v, \bar{w}]	(5) $y,\bar{x}+y,z$ [$\bar{v},u-v,\bar{w}$]	(6) x-y,x,z [$\bar{u}+v,\bar{u},\bar{w}$]
	(7) y,x, \bar{z} [\bar{v},\bar{u},w]	(8) x-y, \bar{y},\bar{z} [$\bar{u}+v,v,w$]	(9) $\bar{x},\bar{x}+y,\bar{z}$ [u,u-v,w]
	(10) \bar{y},\bar{x},\bar{z} [\bar{v},\bar{u},\bar{w}]	(11) $\bar{x}+y,y,\bar{z}$ [$\bar{u}+v,v,\bar{w}$]	(12) x,x-y, \bar{z} [u,u-v, \bar{w}]
	(13) \bar{x},\bar{y},\bar{z} [u,v,w]	(14) $y,\bar{x}+y,\bar{z}$ [$\bar{v},u-v,w$]	(15) x-y,x, \bar{z} [$\bar{u}+v,\bar{u},w$]
	(16) x,y, \bar{z} [u,v, \bar{w}]	(17) $\bar{y},x-y,\bar{z}$ [$\bar{v},u-v,\bar{w}$]	(18) $\bar{x}+y,\bar{x},\bar{z}$ [$\bar{u}+v,\bar{u},\bar{w}$]
	(19) \bar{y},\bar{x},z [\bar{v},\bar{u},w]	(20) $\bar{x}+y,y,z$ [$\bar{u}+v,v,w$]	(21) x,x-y,z [u,u-v,w]
	(22) y,x,z [\bar{v},\bar{u},\bar{w}]	(23) x-y, \bar{y},z [$\bar{u}+v,v,\bar{w}$]	(24) $\bar{x},\bar{x}+y,z$ [u,u-v, \bar{w}]
12 k m'..	x,y,1/2 [u,v,0]	$\bar{y},x-y,1/2$ [$\bar{v},u-v,0$]	$\bar{x}+y,\bar{x},1/2$ [$\bar{u}+v,\bar{u},0$]
	$\bar{x},\bar{y},1/2$ [u,v,0]	$y,\bar{x}+y,1/2$ [$\bar{v},u-v,0$]	x-y,x,1/2 [$\bar{u}+v,\bar{u},0$]
	y,x,1/2 [$\bar{v},\bar{u},0$]	x-y, $\bar{y},1/2$ [$\bar{u}+v,v,0$]	$\bar{x},\bar{x}+y,1/2$ [u,u-v,0]
	$\bar{y},\bar{x},1/2$ [$\bar{v},\bar{u},0$]	$\bar{x}+y,y,1/2$ [$\bar{u}+v,v,0$]	x,x-y,1/2 [u,u-v,0]
12 j m'..	x,y,0 [u,v,0]	$\bar{y},x-y,0$ [$\bar{v},u-v,0$]	$\bar{x}+y,\bar{x},0$ [$\bar{u}+v,\bar{u},0$]
	$\bar{x},\bar{y},0$ [u,v,0]	$y,\bar{x}+y,0$ [$\bar{v},u-v,0$]	x-y,x,0 [$\bar{u}+v,\bar{u},0$]
	y,x,0 [$\bar{v},\bar{u},0$]	x-y, $\bar{y},0$ [$\bar{u}+v,v,0$]	$\bar{x},\bar{x}+y,0$ [u,u-v,0]
	$\bar{y},\bar{x},0$ [$\bar{v},\bar{u},0$]	$\bar{x}+y,y,0$ [$\bar{u}+v,v,0$]	x,x-y,0 [u,u-v,0]

Continued

No. 73.6.374

p6'/m'm'm

12 i .m'	x,2x,z [u,2u,w]	2 \bar{x} , \bar{x} ,z [2 \bar{u} , \bar{u} ,w]	x, \bar{x} ,z [u, \bar{u} ,w]
	\bar{x} ,2 \bar{x} ,z [u,2u, \bar{w}]	2x,x,z [2 \bar{u} , \bar{u} , \bar{w}]	\bar{x} ,x,z [u, \bar{u} , \bar{w}]
	2x,x, \bar{z} [2 \bar{u} , \bar{u} ,w]	\bar{x} ,2 \bar{x} , \bar{z} [u,2u,w]	\bar{x} ,x, \bar{z} [u, \bar{u} ,w]
	2 \bar{x} , \bar{x} , \bar{z} [2 \bar{u} , \bar{u} , \bar{w}]	x,2x, \bar{z} [u,2u, \bar{w}]	x, \bar{x} , \bar{z} [u, \bar{u} , \bar{w}]
12 h ..m	x,0,z [u,2u,0]	0,x,z [2 \bar{u} , \bar{u} ,0]	\bar{x} , \bar{x} ,z [u, \bar{u} ,0]
	\bar{x} ,0,z [u,2u,0]	0, \bar{x} ,z [2 \bar{u} , \bar{u} ,0]	x,x,z [u, \bar{u} ,0]
	0,x, \bar{z} [2 \bar{u} , \bar{u} ,0]	x,0, \bar{z} [u,2u,0]	\bar{x} , \bar{x} , \bar{z} [u, \bar{u} ,0]
	0, \bar{x} , \bar{z} [2 \bar{u} , \bar{u} ,0]	\bar{x} ,0, \bar{z} [u,2u,0]	x,x, \bar{z} [u, \bar{u} ,0]
6 g m'm'2	x,2x,1/2 [u,2u,0]	2 \bar{x} , \bar{x} ,1/2 [2 \bar{u} , \bar{u} ,0]	x, \bar{x} ,1/2 [u, \bar{u} ,0]
	\bar{x} ,2 \bar{x} ,1/2 [u,2u,0]	2x,x,1/2 [2 \bar{u} , \bar{u} ,0]	\bar{x} ,x,1/2 [u, \bar{u} ,0]
6 f m'm'2	x,2x,0 [u,2u,0]	2 \bar{x} , \bar{x} ,0 [2 \bar{u} , \bar{u} ,0]	x, \bar{x} ,0 [u, \bar{u} ,0]
	\bar{x} ,2 \bar{x} ,0 [u,2u,0]	2x,x,0 [2 \bar{u} , \bar{u} ,0]	\bar{x} ,x,0 [u, \bar{u} ,0]
6 e m'2'm	x,0,1/2 [u,2u,0]	0,x,1/2 [2 \bar{u} , \bar{u} ,0]	\bar{x} , \bar{x} ,1/2 [u, \bar{u} ,0]
	\bar{x} ,0,1/2 [u,2u,0]	0, \bar{x} ,1/2 [2 \bar{u} , \bar{u} ,0]	x,x,1/2 [u, \bar{u} ,0]
6 d m'2'm	x,0,0 [u,2u,0]	0,x,0 [2 \bar{u} , \bar{u} ,0]	\bar{x} , \bar{x} ,0 [u, \bar{u} ,0]
	\bar{x} ,0,0 [u,2u,0]	0, \bar{x} ,0 [2 \bar{u} , \bar{u} ,0]	x,x,0 [u, \bar{u} ,0]
2 c 6'm'm	0,0,z [0,0,0]	0,0, \bar{z} [0,0,0]	
1 b 6'/m'm'm	0,0,1/2 [0,0,0]		
1 a 6'/m'm'm	0,0,0 [0,0,0]		

Continued

No. 73.6.374

$p6'/m'm'm$

Symmetry of special projections

Along [001] $6mm1'$

Origin at 0,0,z

Along [100] $p2'm'm$

$a^* = c$

Origin at x,0,0

Along [210] $p2mm1'$

$a^* = c$

Origin at x,x/2,0

$p6'/mmm'$

$6'/mmm'$

Hexagonal

No. 73.7.375

$p6'/m2'/m2'/m'$

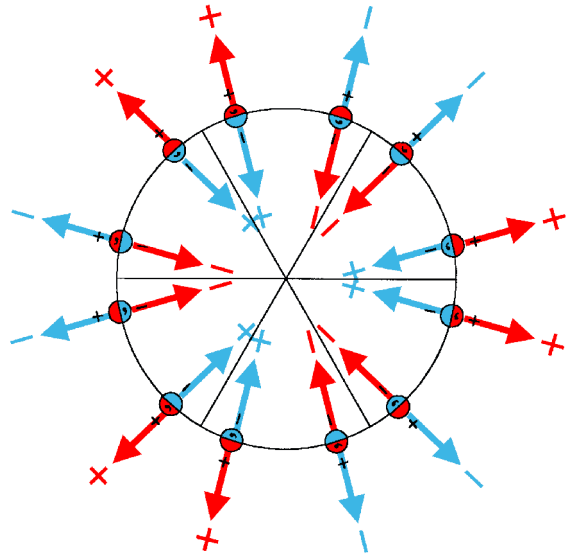
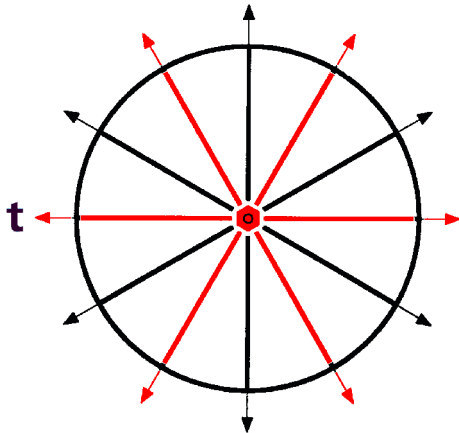

Origin at center ($6'/mmm'$)

Asymmetric unit $0 \leq x$; $0 \leq y$; $0 \leq z \leq 1/2$; $y \leq x/2$

Symmetry operations

- | | | |
|--|---|--|
| (1) 1
(1 0,0,0) | (2) 3^+ 0,0,z
(3_z 0,0,0) | (3) 3^- 0,0,z
(3_z^{-1} 0,0,0) |
| (4) $2'$ 0,0,z
(2_z 0,0,0)' | (5) 6^- 0,0,z
(6_z^{-1} 0,0,0)' | (6) 6^+ 0,0,z
(6_z 0,0,0)' |
| (7) $2'$ x,x,0
(2_{xy} 0,0,0)' | (8) $2'$ x,0,0
(2_x 0,0,0)' | (9) $2'$ 0,y,0
(2_y 0,0,0)' |
| (10) 2 x, \bar{x} ,0
(2_3 0,0,0) | (11) 2 x,2x,0
(2_2 0,0,0) | (12) 2 2x,x,0
(2_1 0,0,0) |
| (13) $\bar{1}$ 0,0,0
($\bar{1}$ 0,0,0)' | (14) $\bar{3}^+$ 0,0,z; 0,0,0
($\bar{3}_z$ 0,0,0)' | (15) $\bar{3}^-$ 0,0,z; 0,0,0
($\bar{3}_z^{-1}$ 0,0,0)' |
| (16) m x,y,0
(m_z 0,0,0) | (17) $\bar{6}^-$ 0,0,z; 0,0,0
($\bar{6}_z^{-1}$ 0,0,0) | (18) $\bar{6}^+$ 0,0,z; 0,0,0
($\bar{6}_z$ 0,0,0) |
| (19) m x, \bar{x} ,z
(m_{xy} 0,0,0) | (20) m x,2x,z
(m_x 0,0,0) | (21) m 2x,x,z
(m_y 0,0,0) |
| (22) m' x,x,z
(m_3 0,0,0)' | (23) m' x,0,z
(m_2 0,0,0)' | (24) m' 0,y,z
(m_1 0,0,0)' |

Generators selected (1); t(0,0,1); (2); (4); (7); (13)

Positions

	Coordinates		
Multiplicity, Wyckoff letter, Site symmetry			
24 l 1	(1) x,y,z [u,v,w]	(2) $\bar{y},x-y,z$ [$\bar{v},u-v,w$]	(3) $\bar{x}+y,\bar{x},z$ [$\bar{u}+v,\bar{u},w$]
	(4) \bar{x},\bar{y},z [u,v, \bar{w}]	(5) $y,\bar{x}+y,z$ [$\bar{v},u-v,\bar{w}$]	(6) x-y,x,z [$\bar{u}+v,\bar{u},\bar{w}$]
	(7) y,x, \bar{z} [\bar{v},\bar{u},w]	(8) x-y, \bar{y},\bar{z} [$\bar{u}+v,v,w$]	(9) $\bar{x},\bar{x}+y,\bar{z}$ [u,u-v,w]
	(10) \bar{y},\bar{x},\bar{z} [\bar{v},\bar{u},\bar{w}]	(11) $\bar{x}+y,y,\bar{z}$ [$\bar{u}+v,v,\bar{w}$]	(12) x,x-y, \bar{z} [u,u-v, \bar{w}]
	(13) \bar{x},\bar{y},\bar{z} [\bar{u},\bar{v},\bar{w}]	(14) $y,\bar{x}+y,\bar{z}$ [v, $\bar{u}+v,\bar{w}$]	(15) x-y,x, \bar{z} [u-v,u, \bar{w}]
	(16) x,y, \bar{z} [\bar{u},\bar{v},w]	(17) $\bar{y},x-y,\bar{z}$ [v, $\bar{u}+v,w$]	(18) $\bar{x}+y,\bar{x},\bar{z}$ [u-v,u,w]
	(19) \bar{y},\bar{x},z [v,u, \bar{w}]	(20) $\bar{x}+y,y,z$ [u-v, \bar{v},\bar{w}]	(21) x,x-y,z [$\bar{u},\bar{u}+v,\bar{w}$]
	(22) y,x,z [v,u,w]	(23) x-y, \bar{y},z [u-v, \bar{v},w]	(24) $\bar{x},\bar{x}+y,z$ [$\bar{u},\bar{u}+v,w$]
12 k m..	x,y,1/2 [0,0,w]	$\bar{y},x-y,1/2$ [0,0,w]	$\bar{x}+y,\bar{x},1/2$ [0,0,w]
	$\bar{x},\bar{y},1/2$ [0,0, \bar{w}]	$y,\bar{x}+y,1/2$ [0,0, \bar{w}]	x-y,x,1/2 [0,0, \bar{w}]
	y,x,1/2 [0,0,w]	x-y, $\bar{y},1/2$ [0,0,w]	$\bar{x},\bar{x}+y,1/2$ [0,0,w]
	$\bar{y},\bar{x},1/2$ [0,0, \bar{w}]	$\bar{x}+y,y,1/2$ [0,0, \bar{w}]	x,x-y,1/2 [0,0, \bar{w}]
12 j m..	x,y,0 [0,0,w]	$\bar{y},x-y,0$ [0,0,w]	$\bar{x}+y,\bar{x},0$ [0,0,w]
	$\bar{x},\bar{y},0$ [0,0, \bar{w}]	$y,\bar{x}+y,0$ [0,0, \bar{w}]	x-y,x,0 [0,0, \bar{w}]
	y,x,0 [0,0,w]	x-y, $\bar{y},0$ [0,0,w]	$\bar{x},\bar{x}+y,0$ [0,0,w]
	$\bar{y},\bar{x},0$ [0,0, \bar{w}]	$\bar{x}+y,y,0$ [0,0, \bar{w}]	x,x-y,0 [0,0, \bar{w}]

Continued		No. 73.7.375	$p6'/mmm'$
12 i .m.	$x, 2x, z [u, 0, 0]$	$2\bar{x}, \bar{x}, z [0, u, 0]$	$x, \bar{x}, z [\bar{u}, \bar{u}, 0]$
	$\bar{x}, 2\bar{x}, z [u, 0, 0]$	$2x, x, z [0, u, 0]$	$\bar{x}, x, z [\bar{u}, \bar{u}, 0]$
	$2x, x, \bar{z} [0, \bar{u}, 0]$	$\bar{x}, 2\bar{x}, \bar{z} [\bar{u}, 0, 0]$	$\bar{x}, x, \bar{z} [u, u, 0]$
	$2\bar{x}, \bar{x}, \bar{z} [0, \bar{u}, 0]$	$x, 2x, \bar{z} [\bar{u}, 0, 0]$	$x, \bar{x}, \bar{z} [u, u, 0]$
12 h ..m'	$x, 0, z [u, 0, w]$	$0, x, z [0, u, w]$	$\bar{x}, \bar{x}, z [\bar{u}, \bar{u}, w]$
	$\bar{x}, 0, z [u, 0, \bar{w}]$	$0, \bar{x}, z [0, u, \bar{w}]$	$x, x, z [\bar{u}, \bar{u}, \bar{w}]$
	$0, x, \bar{z} [0, \bar{u}, w]$	$x, 0, \bar{z} [\bar{u}, 0, w]$	$\bar{x}, \bar{x}, \bar{z} [u, u, w]$
	$0, \bar{x}, \bar{z} [0, \bar{u}, \bar{w}]$	$\bar{x}, 0, \bar{z} [\bar{u}, 0, \bar{w}]$	$x, x, \bar{z} [u, u, \bar{w}]$
6 g mm2	$x, 2x, 1/2 [0, 0, 0]$	$2\bar{x}, \bar{x}, 1/2 [0, 0, 0]$	$x, \bar{x}, 1/2 [0, 0, 0]$
	$\bar{x}, 2\bar{x}, 1/2 [0, 0, 0]$	$2x, x, 1/2 [0, 0, 0]$	$\bar{x}, x, 1/2 [0, 0, 0]$
6 f mm2	$x, 2x, 0 [0, 0, 0]$	$2\bar{x}, \bar{x}, 0 [0, 0, 0]$	$x, \bar{x}, 0 [0, 0, 0]$
	$\bar{x}, 2\bar{x}, 0 [0, 0, 0]$	$2x, x, 0 [0, 0, 0]$	$\bar{x}, x, 0 [0, 0, 0]$
6 e m2'm'	$x, 0, 1/2 [0, 0, w]$	$0, x, 1/2 [0, 0, w]$	$\bar{x}, \bar{x}, 1/2 [0, 0, w]$
	$\bar{x}, 0, 1/2 [0, 0, \bar{w}]$	$0, \bar{x}, 1/2 [0, 0, \bar{w}]$	$x, x, 1/2 [0, 0, \bar{w}]$
6 d m2'm'	$x, 0, 0 [0, 0, w]$	$0, x, 0 [0, 0, w]$	$\bar{x}, \bar{x}, 0 [0, 0, w]$
	$\bar{x}, 0, 0 [0, 0, \bar{w}]$	$0, \bar{x}, 0 [0, 0, \bar{w}]$	$x, x, 0 [0, 0, \bar{w}]$
2 c 6'mm'	$0, 0, z [0, 0, 0]$	$0, 0, \bar{z} [0, 0, 0]$	
1 b 6'/mmm'	$0, 0, 1/2 [0, 0, 0]$		
1 a 6'/mmm'	$0, 0, 0 [0, 0, 0]$		

Continued

No. 73.7.375

$p6'/mmm'$

Symmetry of special projections

Along $[001]$ $6'mm'$

Origin at $0,0,z$

Along $[100]$ $p2mm1'$

$a^* = c$

Origin at $x,0,0$

Along $[210]$ $p2mm$

$a^* = c$

Origin at $x,x/2,0$

$\rho_{2c} 6/mm'm'$

$6/mmm1'$

Hexagonal

No. 73.8.376

$\rho_{2c} 6/mm'm'$

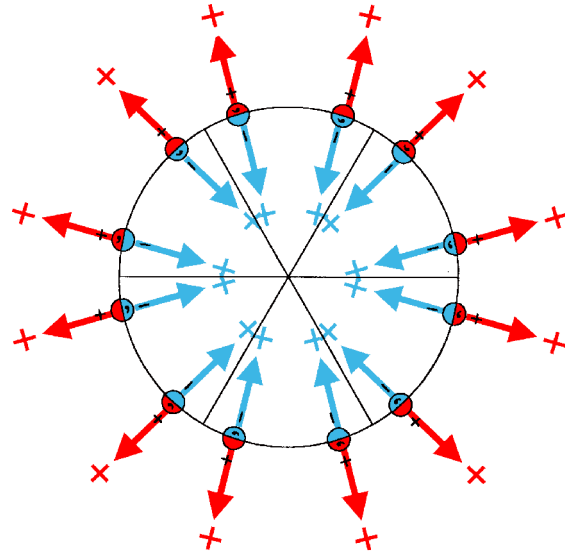
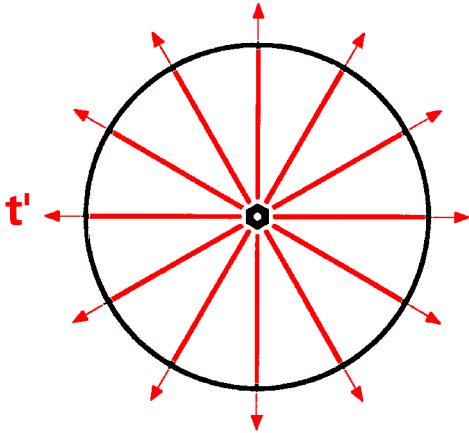

Origin at center ($6/mm'm'$)

Asymmetric unit $0 \leq x$; $0 \leq y$; $0 \leq z \leq 1/2$; $y \leq x/2$

Symmetry operations

For (0,0,0) + set

- | | | |
|--|---|---|
| (1) 1
(1 0,0,0) | (2) 3^+ 0,0,z
(3_z 0,0,0) | (3) 3^- 0,0,z
(3_z^{-1} 0,0,0) |
| (4) 2 0,0,z
(2_z 0,0,0) | (5) 6^- 0,0,z
(6_z^{-1} 0,0,0) | (6) 6^+ 0,0,z
(6_z 0,0,0) |
| (7) $2'$ x,x,0
(2_{xy} 0,0,0)' | (8) $2'$ x,0,0
(2_x 0,0,0)' | (9) $2'$ 0,y,0
(2_y 0,0,0)' |
| (10) $2'$ x, \bar{x} ,0
(2_3 0,0,0)' | (11) $2'$ x,2x,0
(2_2 0,0,0)' | (12) $2'$ 2x,x,0
(2_1 0,0,0)' |
| (13) $\bar{1}$ 0,0,0
($\bar{1}$ 0,0,0) | (14) $\bar{3}^+$ 0,0,z; 0,0,0
($\bar{3}_z$ 0,0,0) | (15) $\bar{3}^-$ 0,0,z; 0,0,0
($\bar{3}_z^{-1}$ 0,0,0) |
| (16) m x,y,0
(m_z 0,0,0) | (17) $\bar{6}^-$ 0,0,z; 0,0,0
($\bar{6}_z^{-1}$ 0,0,0) | (18) $\bar{6}^+$ 0,0,z; 0,0,0
($\bar{6}_z$ 0,0,0) |
| (19) m' x, \bar{x} ,z
(m_{xy} 0,0,0)' | (20) m' x,2x,z
(m_x 0,0,0)' | (21) m' 2x,x,z
(m_y 0,0,0)' |
| (22) m' x,x,z
(m_3 0,0,0)' | (23) m' x,0,z
(m_2 0,0,0)' | (24) m' 0,y,z
(m_1 0,0,0)' |

For $(0,0,1)'$ + set

$$(1) t' (0,0,1) \\ (1|0,0,1)'$$

$$(4) 2' (0,0,1) \quad 0,0,z \\ (2_z|0,0,1)'$$

$$(7) 2 \quad x,x,1/2 \\ (2_{xy}|0,0,1)$$

$$(10) 2 \quad x,\bar{x},1/2 \\ (2_3|0,0,1)$$

$$(13) \bar{1}' \quad 0,0,1/2 \\ (\bar{1}|0,0,1)'$$

$$(16) m' \quad x,y,1/2 \\ (m_z|0,0,1)'$$

$$(19) c (0,0,1) \quad x,\bar{x},z \\ (m_{xy}|0,0,1)$$

$$(22) c (0,0,1) \quad x,x,z \\ (m_3|0,0,1)$$

$$(2) 3^{+'} (0,0,1) \quad 0,0,z \\ (3_z|0,0,1)'$$

$$(5) 6^{-'} (0,0,1) \quad 0,0,z \\ (6_z^{-1}|0,0,1)'$$

$$(8) 2 \quad x,0,1/2 \\ (2_x|0,0,1)$$

$$(11) 2 \quad x,2x,1/2 \\ (2_2|0,0,1)$$

$$(14) \bar{3}^{+'} \quad 0,0,z; 0,0,1/2 \\ (\bar{3}_z|0,0,1)'$$

$$(17) \bar{6}^{-'} \quad 0,0,z; 0,0,1/2 \\ (\bar{6}_z^{-1}|0,0,1)'$$

$$(20) c (0,0,1) \quad x,2x,z \\ (m_x|0,0,1)$$

$$(23) c (0,0,1) \quad x,0,z \\ (m_2|0,0,1)$$

$$(3) 3^{-'} (0,0,1) \quad 0,0,z \\ (3_z^{-1}|0,0,1)'$$

$$(6) 6^{+'} (0,0,1) \quad 0,0,z \\ (6_z|0,0,1)'$$

$$(9) 2 \quad 0,y,1/2 \\ (2_y|0,0,1)$$

$$(12) 2 \quad 2x,x,1/2 \\ (2_1|0,0,1)$$

$$(15) \bar{3}^{-'} \quad 0,0,z; 0,0,1/2 \\ (\bar{3}_z^{-1}|0,0,1)'$$

$$(18) \bar{6}^{+'} \quad 0,0,z; 0,0,1/2 \\ (\bar{6}_z|0,0,1)'$$

$$(21) c (0,0,1) \quad 2x,x,z \\ (m_y|0,0,1)$$

$$(24) c (0,0,1) \quad 0,y,z \\ (m_1|0,0,1)$$

Generators selected (1); $t(0,0,1)'$; (2); (4); (7); (13)

Positions

Multiplicity, Wyckoff letter, Site symmetry	Coordinates		
		(0,0,0)+	(0,0,1)' +
24 l 1	(1) $x,y,z [u,v,w]$	(2) $\bar{y},x-y,z [\bar{v},u-v,w]$	(3) $\bar{x}+y,\bar{x},z [\bar{u}+v,\bar{u},w]$
	(4) $\bar{x},\bar{y},z [\bar{u},\bar{v},w]$	(5) $y,\bar{x}+y,z [v,\bar{u}+v,w]$	(6) $x-y,x,z [u-v,u,w]$
	(7) $y,x,\bar{z} [\bar{v},\bar{u},w]$	(8) $x-y,\bar{y},\bar{z} [\bar{u}+v,v,w]$	(9) $\bar{x},\bar{x}+y,\bar{z} [u,u-v,w]$
	(10) $\bar{y},\bar{x},\bar{z} [v,u,w]$	(11) $\bar{x}+y,y,\bar{z} [u-v,\bar{v},w]$	(12) $x,x-y,\bar{z} [\bar{u},\bar{u}+v,w]$
	(13) $\bar{x},\bar{y},\bar{z} [u,v,w]$	(14) $y,\bar{x}+y,\bar{z} [\bar{v},u-v,w]$	(15) $x-y,x,\bar{z} [\bar{u}+v,\bar{u},w]$
	(16) $x,y,\bar{z} [\bar{u},\bar{v},w]$	(17) $\bar{y},x-y,\bar{z} [v,\bar{u}+v,w]$	(18) $\bar{x}+y,\bar{x},\bar{z} [u-v,u,w]$
	(19) $\bar{y},\bar{x},z [\bar{v},\bar{u},w]$	(20) $\bar{x}+y,y,z [\bar{u}+v,v,w]$	(21) $x,x-y,z [u,u-v,w]$
	(22) $y,x,z [v,u,w]$	(23) $x-y,\bar{y},z [u-v,\bar{v},w]$	(24) $\bar{x},\bar{x}+y,z [\bar{u},\bar{u}+v,w]$
12 k $m'\bar{..}$	$x,y,1/2 [u,v,0]$	$\bar{y},x-y,1/2 [\bar{v},u-v,0]$	$\bar{x}+y,\bar{x},1/2 [\bar{u}+v,\bar{u},0]$
	$\bar{x},\bar{y},1/2 [\bar{u},\bar{v},0]$	$y,\bar{x}+y,1/2 [v,\bar{u}+v,0]$	$x-y,x,1/2 [u-v,u,0]$
	$y,x,1/2 [\bar{v},\bar{u},0]$	$x-y,\bar{y},1/2 [\bar{u}+v,v,0]$	$\bar{x},\bar{x}+y,1/2 [u,u-v,0]$
	$\bar{y},\bar{x},1/2 [v,u,0]$	$\bar{x}+y,y,1/2 [u-v,\bar{v},0]$	$x,x-y,1/2 [\bar{u},\bar{u}+v,0]$
12 j $m\bar{..}$	$x,y,0 [0,0,w]$	$\bar{y},x-y,0 [0,0,w]$	$\bar{x}+y,\bar{x},0 [0,0,w]$
	$\bar{x},\bar{y},0 [0,0,w]$	$y,\bar{x}+y,0 [0,0,w]$	$x-y,x,0 [0,0,w]$
	$y,x,0 [0,0,w]$	$x-y,\bar{y},0 [0,0,w]$	$\bar{x},\bar{x}+y,0 [0,0,w]$
	$\bar{y},\bar{x},0 [0,0,w]$	$\bar{x}+y,y,0 [0,0,w]$	$x,x-y,0 [0,0,w]$

Continued

No. 73.8.376

 $p_{2c} 6/mm'm'$

12 i .m'	$x, 2x, z [u, 2u, w]$	$2\bar{x}, \bar{x}, z [2\bar{u}, \bar{u}, w]$	$x, \bar{x}, z [u, \bar{u}, w]$
	$\bar{x}, 2\bar{x}, z [\bar{u}, 2\bar{u}, w]$	$2x, x, z [2u, u, w]$	$\bar{x}, x, z [\bar{u}, u, w]$
	$2x, x, \bar{z} [2\bar{u}, \bar{u}, w]$	$\bar{x}, 2\bar{x}, \bar{z} [u, 2u, w]$	$\bar{x}, x, \bar{z} [u, \bar{u}, w]$
	$2\bar{x}, \bar{x}, \bar{z} [2u, u, w]$	$x, 2x, \bar{z} [\bar{u}, 2\bar{u}, w]$	$x, \bar{x}, \bar{z} [\bar{u}, u, w]$
12 h ..m'	$x, 0, z [u, 0, w]$	$0, x, z [0, u, w]$	$\bar{x}, \bar{x}, z [\bar{u}, \bar{u}, w]$
	$\bar{x}, 0, z [\bar{u}, 0, w]$	$0, \bar{x}, z [0, \bar{u}, w]$	$x, x, z [u, u, w]$
	$0, x, \bar{z} [0, \bar{u}, w]$	$x, 0, \bar{z} [\bar{u}, 0, w]$	$\bar{x}, \bar{x}, \bar{z} [u, u, w]$
	$0, \bar{x}, \bar{z} [0, u, w]$	$\bar{x}, 0, \bar{z} [u, 0, w]$	$x, x, \bar{z} [\bar{u}, \bar{u}, w]$
6 g m'm'2	$x, 2x, 1/2 [u, 2u, 0]$	$2\bar{x}, \bar{x}, 1/2 [2\bar{u}, \bar{u}, 0]$	$x, \bar{x}, 1/2 [u, \bar{u}, 0]$
	$\bar{x}, 2\bar{x}, 1/2 [\bar{u}, 2\bar{u}, 0]$	$2x, x, 1/2 [2u, u, 0]$	$\bar{x}, x, 1/2 [\bar{u}, u, 0]$
6 f mm'2'	$x, 2x, 0 [0, 0, w]$	$2\bar{x}, \bar{x}, 0 [0, 0, w]$	$x, \bar{x}, 0 [0, 0, w]$
	$\bar{x}, 2\bar{x}, 0 [0, 0, w]$	$2x, x, 0 [0, 0, w]$	$\bar{x}, x, 0 [0, 0, w]$
6 e m'2m'	$x, 0, 1/2 [u, 0, 0]$	$0, x, 1/2 [0, u, 0]$	$\bar{x}, \bar{x}, 1/2 [\bar{u}, \bar{u}, 0]$
	$\bar{x}, 0, 1/2 [\bar{u}, 0, 0]$	$0, \bar{x}, 1/2 [0, \bar{u}, 0]$	$x, x, 1/2 [u, u, 0]$
6 d m2'm'	$x, 0, 0 [0, 0, w]$	$0, x, 0 [0, 0, w]$	$\bar{x}, \bar{x}, 0 [0, 0, w]$
	$\bar{x}, 0, 0 [0, 0, w]$	$0, \bar{x}, 0 [0, 0, w]$	$x, x, 0 [0, 0, w]$
2 c 6m'm'	$0, 0, z [0, 0, w]$	$0, 0, \bar{z} [0, 0, w]$	
1 b 6/m'm'm'	$0, 0, 1/2 [0, 0, 0]$		
1 a 6/mm'm'	$0, 0, 0 [0, 0, w]$		

Continued

No. 73.8.376

$p_{2c} 6/mm'm'$

Symmetry of special projections

Along [001] $6mm1'$

Origin at 0,0,z

Along [100] $p_{2a^*} 2'mm'$

$a^* = c$

Origin at x,0,0

Along [210] $p_{2a^*} 2'mm'$

$a^* = c$

Origin at x,x/2,0

$\rho_{2c} 6'/m'mm'$

$6'/m'mm'$

Hexagonal

No. 73.9.377

$\rho_{2c} 6'/m'mm'$

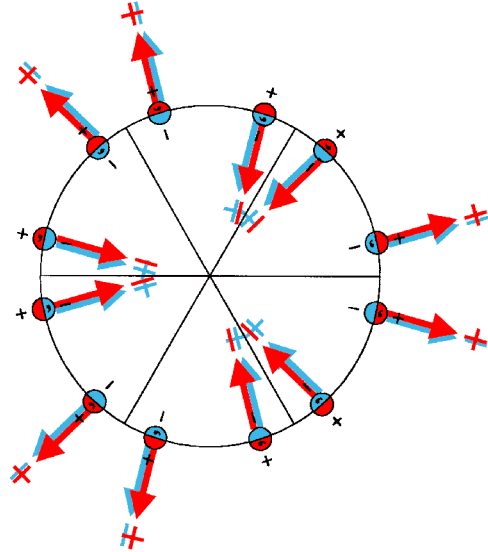
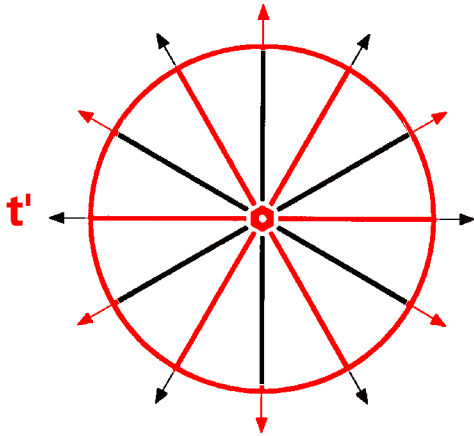

Origin at center ($6'/m'mm'$)

Asymmetric unit $0 \leq x$; $0 \leq y$; $0 \leq z \leq 1/2$; $y \leq x/2$

Symmetry operations

For (0,0,0) + set

- | | | |
|---|--|---|
| (1) 1
(1 0,0,0) | (2) 3^+ 0,0,z
(3_z 0,0,0) | (3) 3^- 0,0,z
(3_z^{-1} 0,0,0) |
| (4) $2'$ 0,0,z
(2_z 0,0,0)' | (5) 6^- 0,0,z
(6_z^{-1} 0,0,0)' | (6) 6^+ 0,0,z
(6_z 0,0,0)' |
| (7) 2 x,x,0
(2_{xy} 0,0,0) | (8) 2 x,0,0
(2_x 0,0,0) | (9) 2 0,y,0
(2_y 0,0,0) |
| (10) $2'$ x, \bar{x} ,0
(2_3 0,0,0)' | (11) $2'$ x,2x,0
(2_2 0,0,0)' | (12) $2'$ 2x,x,0
(2_1 0,0,0)' |
| (13) $\bar{1}$ 0,0,0
($\bar{1}$ 0,0,0) | (14) $\bar{3}^+$ 0,0,z; 0,0,0
($\bar{3}_z$ 0,0,0) | (15) $\bar{3}^-$ 0,0,z; 0,0,0
($\bar{3}_z^{-1}$ 0,0,0) |
| (16) m' x,y,0
(m_z 0,0,0)' | (17) $\bar{6}^-$ 0,0,z; 0,0,0
($\bar{6}_z^{-1}$ 0,0,0)' | (18) $\bar{6}^+$ 0,0,z; 0,0,0
($\bar{6}_z$ 0,0,0)' |
| (19) m x, \bar{x} ,z
(m_{xy} 0,0,0) | (20) m x,2x,z
(m_x 0,0,0) | (21) m 2x,x,z
(m_y 0,0,0) |
| (22) m' x,x,z
(m_3 0,0,0)' | (23) m' x,0,z
(m_2 0,0,0)' | (24) m' 0,y,z
(m_1 0,0,0)' |

For $(0,0,1)'$ + set

$$(1) t' (0,0,1) \\ (1|0,0,1)'$$

$$(4) 2 (0,0,1) \quad 0,0,z \\ (2_z|0,0,1)$$

$$(7) 2' \quad x,x,1/2 \\ (2_{xy}|0,0,1)'$$

$$(10) 2 \quad x,\bar{x},1/2 \\ (2_3|0,0,1)$$

$$(13) \bar{1}' \quad 0,0,1/2 \\ (\bar{1}|0,0,1)'$$

$$(16) m \quad x,y,1/2 \\ (m_z|0,0,1)$$

$$(19) c' (0,0,1) \quad x,\bar{x},z \\ (m_{xy}|0,0,1)'$$

$$(22) c (0,0,1) \quad x,x,z \\ (m_3|0,0,1)$$

$$(2) 3^{+'} (0,0,1) \quad 0,0,z \\ (3_z|0,0,1)'$$

$$(5) 6^- (0,0,1) \quad 0,0,z \\ (6_z^{-1}|0,0,1)$$

$$(8) 2' \quad x,0,1/2 \\ (2_x|0,0,1)'$$

$$(11) 2 \quad x,2x,1/2 \\ (2_2|0,0,1)$$

$$(14) \bar{3}^{+'} \quad 0,0,z; 0,0,1/2 \\ (\bar{3}_z|0,0,1)'$$

$$(17) \bar{6}^- \quad 0,0,z; 0,0,1/2 \\ (\bar{6}_z^{-1}|0,0,1)$$

$$(20) c' (0,0,1) \quad x,2x,z \\ (m_x|0,0,1)'$$

$$(23) c (0,0,1) \quad x,0,z \\ (m_2|0,0,1)$$

$$(3) 3^{-'} (0,0,1) \quad 0,0,z \\ (3_z^{-1}|0,0,1)'$$

$$(6) 6^+ (0,0,1) \quad 0,0,z \\ (6_z|0,0,1)$$

$$(9) 2' \quad 0,y,1/2 \\ (2_y|0,0,1)'$$

$$(12) 2 \quad 2x,x,1/2 \\ (2_1|0,0,1)$$

$$(15) \bar{3}^{-'} \quad 0,0,z; 0,0,1/2 \\ (\bar{3}_z^{-1}|0,0,1)'$$

$$(18) \bar{6}^+ \quad 0,0,z; 0,0,1/2 \\ (\bar{6}_z|0,0,1)$$

$$(21) c' (0,0,1) \quad 2x,x,z \\ (m_y|0,0,1)'$$

$$(24) c (0,0,1) \quad 0,y,z \\ (m_1|0,0,1)$$

Generators selected (1); $t(0,0,1)'$; (2); (4); (7); (13)

Positions

Multiplicity, Wyckoff letter, Site symmetry	Coordinates		
		(0,0,0)+	(0,0,1)' +
24 l 1	(1) $x,y,z [u,v,w]$	(2) $\bar{y},x-y,z [\bar{v},u-v,w]$	(3) $\bar{x}+y,\bar{x},z [\bar{u}+v,\bar{u},w]$
	(4) $\bar{x},\bar{y},z [u,v,\bar{w}]$	(5) $y,\bar{x}+y,z [\bar{v},u-v,\bar{w}]$	(6) $x-y,x,z [\bar{u}+v,\bar{u},\bar{w}]$
	(7) $y,x,\bar{z} [v,u,\bar{w}]$	(8) $x-y,\bar{y},\bar{z} [u-v,\bar{v},\bar{w}]$	(9) $\bar{x},\bar{x}+y,\bar{z} [\bar{u},\bar{u}+v,\bar{w}]$
	(10) $\bar{y},\bar{x},\bar{z} [v,u,w]$	(11) $\bar{x}+y,y,\bar{z} [u-v,\bar{v},w]$	(12) $x,x-y,\bar{z} [\bar{u},\bar{u}+v,w]$
	(13) $\bar{x},\bar{y},\bar{z} [u,v,w]$	(14) $y,\bar{x}+y,\bar{z} [\bar{v},u-v,w]$	(15) $x-y,x,\bar{z} [\bar{u}+v,\bar{u},w]$
	(16) $x,y,\bar{z} [u,v,\bar{w}]$	(17) $\bar{y},x-y,\bar{z} [\bar{v},u-v,\bar{w}]$	(18) $\bar{x}+y,\bar{x},\bar{z} [\bar{u}+v,\bar{u},\bar{w}]$
	(19) $\bar{y},\bar{x},z [v,u,\bar{w}]$	(20) $\bar{x}+y,y,z [u-v,\bar{v},\bar{w}]$	(21) $x,x-y,z [\bar{u},\bar{u}+v,\bar{w}]$
	(22) $y,x,z [v,u,w]$	(23) $x-y,\bar{y},z [u-v,\bar{v},w]$	(24) $\bar{x},\bar{x}+y,z [\bar{u},\bar{u}+v,w]$
12 k m..	$x,y,1/2 [0,0,w]$	$\bar{y},x-y,1/2 [0,0,w]$	$\bar{x}+y,\bar{x},1/2 [0,0,w]$
	$\bar{x},\bar{y},1/2 [0,0,\bar{w}]$	$y,\bar{x}+y,1/2 [0,0,\bar{w}]$	$x-y,x,1/2 [0,0,\bar{w}]$
	$y,x,1/2 [0,0,\bar{w}]$	$x-y,\bar{y},1/2 [0,0,\bar{w}]$	$\bar{x},\bar{x}+y,1/2 [0,0,\bar{w}]$
	$\bar{y},\bar{x},1/2 [0,0,w]$	$\bar{x}+y,y,1/2 [0,0,w]$	$x,x-y,1/2 [0,0,w]$
12 j m'..	$x,y,0 [u,v,0]$	$\bar{y},x-y,0 [\bar{v},u-v,0]$	$\bar{x}+y,\bar{x},0 [\bar{u}+v,\bar{u},0]$
	$\bar{x},\bar{y},0 [u,v,0]$	$y,\bar{x}+y,0 [\bar{v},u-v,0]$	$x-y,x,0 [\bar{u}+v,\bar{u},0]$
	$y,x,0 [v,u,0]$	$x-y,\bar{y},0 [u-v,\bar{v},0]$	$\bar{x},\bar{x}+y,0 [\bar{u},\bar{u}+v,0]$
	$\bar{y},\bar{x},0 [v,u,0]$	$\bar{x}+y,y,0 [u-v,\bar{v},0]$	$x,x-y,0 [\bar{u},\bar{u}+v,0]$

Continued

No. 73.9.377

 $p_{2c} 6'/m'mm'$

12 i .m.	$x, 2x, z [u, 0, 0]$	$2\bar{x}, \bar{x}, z [0, u, 0]$	$x, \bar{x}, z [\bar{u}, \bar{u}, 0]$
	$\bar{x}, 2\bar{x}, z [u, 0, 0]$	$2x, x, z [0, u, 0]$	$\bar{x}, x, z [\bar{u}, \bar{u}, 0]$
	$2x, x, \bar{z} [0, u, 0]$	$\bar{x}, 2\bar{x}, \bar{z} [u, 0, 0]$	$\bar{x}, x, \bar{z} [\bar{u}, \bar{u}, 0]$
	$2\bar{x}, \bar{x}, \bar{z} [0, u, 0]$	$x, 2x, \bar{z} [u, 0, 0]$	$x, \bar{x}, \bar{z} [\bar{u}, \bar{u}, 0]$
12 h ..m'	$x, 0, z [u, 0, w]$	$0, x, z [0, u, w]$	$\bar{x}, \bar{x}, z [\bar{u}, \bar{u}, w]$
	$\bar{x}, 0, z [u, 0, \bar{w}]$	$0, \bar{x}, z [0, u, \bar{w}]$	$x, x, z [\bar{u}, \bar{u}, \bar{w}]$
	$0, x, \bar{z} [0, u, \bar{w}]$	$x, 0, \bar{z} [u, 0, \bar{w}]$	$\bar{x}, \bar{x}, \bar{z} [\bar{u}, \bar{u}, \bar{w}]$
	$0, \bar{x}, \bar{z} [0, u, w]$	$\bar{x}, 0, \bar{z} [u, 0, w]$	$x, x, \bar{z} [\bar{u}, \bar{u}, w]$
6 g mm ²	$x, 2x, 1/2 [0, 0, 0]$	$2\bar{x}, \bar{x}, 1/2 [0, 0, 0]$	$x, \bar{x}, 1/2 [0, 0, 0]$
	$\bar{x}, 2\bar{x}, 1/2 [0, 0, 0]$	$2x, x, 1/2 [0, 0, 0]$	$\bar{x}, x, 1/2 [0, 0, 0]$
6 f m'm ² '	$x, 2x, 0 [u, 0, 0]$	$2\bar{x}, \bar{x}, 0 [0, u, 0]$	$x, \bar{x}, 0 [\bar{u}, \bar{u}, 0]$
	$\bar{x}, 2\bar{x}, 0 [u, 0, 0]$	$2x, x, 0 [0, u, 0]$	$\bar{x}, x, 0 [\bar{u}, \bar{u}, 0]$
6 e m ² m'	$x, 0, 1/2 [0, 0, w]$	$0, x, 1/2 [0, 0, w]$	$\bar{x}, \bar{x}, 1/2 [0, 0, w]$
	$\bar{x}, 0, 1/2 [0, 0, \bar{w}]$	$0, \bar{x}, 1/2 [0, 0, \bar{w}]$	$x, x, 1/2 [0, 0, \bar{w}]$
6 d m ² m'	$x, 0, 0 [u, 0, 0]$	$0, x, 0 [0, u, 0]$	$\bar{x}, \bar{x}, 0 [\bar{u}, \bar{u}, 0]$
	$\bar{x}, 0, 0 [u, 0, 0]$	$0, \bar{x}, 0 [0, u, 0]$	$x, x, 0 [\bar{u}, \bar{u}, 0]$
2 c 6'mm'	$0, 0, z [0, 0, 0]$	$0, 0, \bar{z} [0, 0, 0]$	
1 b 6'/mmm'	$0, 0, 1/2 [0, 0, 0]$		
1 a 6'/m'mm'	$0, 0, 0 [0, 0, 0]$		

Continued

No. 73.9.377

$p_{2c} 6'/m'mm'$

Symmetry of special projections

Along [001] $6mm1'$

Origin at 0,0,z

Along [100] $p2mm1'$

$a^* = c$

Origin at x,0,0

Along [210] $p_{2a^*} 2'm'm$

$a^* = c$

Origin at x,x/2,0

$p_{2c}6/mmm$

$6/mmm$

Hexagonal

No. 73.10.378

$p_{2c}6/mmm$

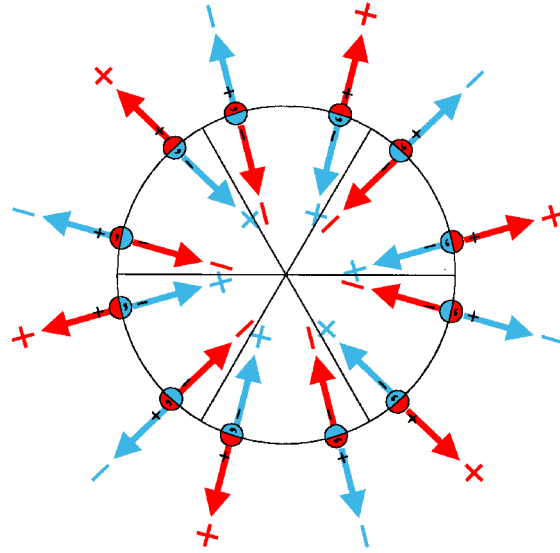
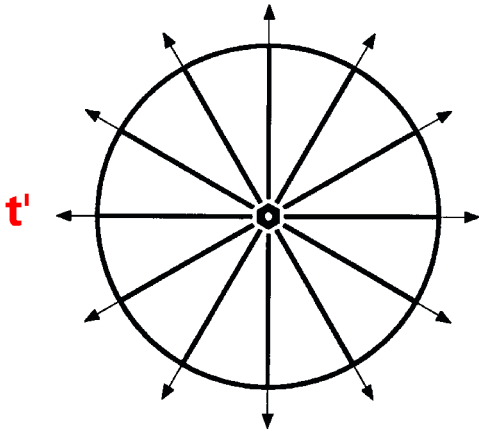

Origin at center ($6/mmm$)

Asymmetric unit $0 \leq x$; $0 \leq y$; $0 \leq z \leq 1/2$; $y \leq x/2$

Symmetry operations

For (0,0,0) + set

- | | | |
|--|---|---|
| (1) 1
(1 0,0,0) | (2) 3^+ 0,0,z
(3_z 0,0,0) | (3) 3^- 0,0,z
(3_z^{-1} 0,0,0) |
| (4) 2 0,0,z
(2_z 0,0,0) | (5) 6^- 0,0,z
(6_z^{-1} 0,0,0) | (6) 6^+ 0,0,z
(6_z 0,0,0) |
| (7) 2 x,x,0
(2_{xy} 0,0,0) | (8) 2 x,0,0
(2_x 0,0,0) | (9) 2 0,y,0
(2_y 0,0,0) |
| (10) 2 x, \bar{x} ,0
(2_3 0,0,0) | (11) 2 x,2x,0
(2_2 0,0,0) | (12) 2 2x,x,0
(2_1 0,0,0) |
| (13) $\bar{1}$ 0,0,0
($\bar{1}$ 0,0,0) | (14) $\bar{3}^+$ 0,0,z; 0,0,0
($\bar{3}_z$ 0,0,0) | (15) $\bar{3}^-$ 0,0,z; 0,0,0
($\bar{3}_z^{-1}$ 0,0,0) |
| (16) m x,y,0
(m_z 0,0,0) | (17) $\bar{6}^-$ 0,0,z; 0,0,0
($\bar{6}_z^{-1}$ 0,0,0) | (18) $\bar{6}^+$ 0,0,z; 0,0,0
($\bar{6}_z$ 0,0,0) |
| (19) m x, \bar{x} ,z
(m_{xy} 0,0,0) | (20) m x,2x,z
(m_x 0,0,0) | (21) m 2x,x,z
(m_y 0,0,0) |
| (22) m x,x,z
(m_3 0,0,0) | (23) m x,0,z
(m_2 0,0,0) | (24) m 0,y,z
(m_1 0,0,0) |

For $(0,0,1)'$ + set

$$(1) t' (0,0,1) \\ (1|0,0,1)'$$

$$(4) 2' (0,0,1) \quad 0,0,z \\ (2_z|0,0,1)'$$

$$(7) 2' \quad x,x,1/2 \\ (2_{xy}|0,0,1)'$$

$$(10) 2' \quad x,\bar{x},1/2 \\ (2_3|0,0,1)'$$

$$(13) \bar{1}' \quad 0,0,1/2 \\ (\bar{1}|0,0,1)'$$

$$(16) m' \quad x,y,1/2 \\ (m_z|0,0,1)'$$

$$(19) c' (0,0,1) \quad x,\bar{x},z \\ (m_{xy}|0,0,1)'$$

$$(22) c' (0,0,1) \quad x,x,z \\ (m_3|0,0,1)'$$

$$(2) 3^{+'} (0,0,1) \quad 0,0,z \\ (3_z|0,0,1)'$$

$$(5) 6^{-'} (0,0,1) \quad 0,0,z \\ (6_z^{-1}|0,0,1)'$$

$$(8) 2' \quad x,0,1/2 \\ (2_x|0,0,1)'$$

$$(11) 2' \quad x,2x,1/2 \\ (2_2|0,0,1)'$$

$$(14) \bar{3}^{+'} \quad 0,0,z; 0,0,1/2 \\ (\bar{3}_z|0,0,1)'$$

$$(17) \bar{6}^{-'} \quad 0,0,z; 0,0,1/2 \\ (\bar{6}_z^{-1}|0,0,1)'$$

$$(20) c' (0,0,1) \quad x,2x,z \\ (m_x|0,0,1)'$$

$$(23) c' (0,0,1) \quad x,0,z \\ (m_2|0,0,1)'$$

$$(3) 3^{-'} (0,0,1) \quad 0,0,z \\ (3_z^{-1}|0,0,1)'$$

$$(6) 6^{+'} (0,0,1) \quad 0,0,z \\ (6_z|0,0,1)'$$

$$(9) 2' \quad 0,y,1/2 \\ (2_y|0,0,1)'$$

$$(12) 2' \quad 2x,x,1/2 \\ (2_1|0,0,1)'$$

$$(15) \bar{3}^{-'} \quad 0,0,z; 0,0,1/2 \\ (\bar{3}_z^{-1}|0,0,1)'$$

$$(18) \bar{6}^{+'} \quad 0,0,z; 0,0,1/2 \\ (\bar{6}_z|0,0,1)'$$

$$(21) c' (0,0,1) \quad 2x,x,z \\ (m_y|0,0,1)'$$

$$(24) c' (0,0,1) \quad 0,y,z \\ (m_1|0,0,1)'$$

Generators selected (1); $t(0,0,1)'$; (2); (4); (7); (13)

Positions

Multiplicity, Wyckoff letter, Site symmetry	Coordinates		
		(0,0,0)+	(0,0,1)' +
24 l 1	(1) $x,y,z [u,v,w]$	(2) $\bar{y},x-y,z [\bar{v},u-v,w]$	(3) $\bar{x}+y,\bar{x},z [\bar{u}+v,\bar{u},w]$
	(4) $\bar{x},\bar{y},z [\bar{u},\bar{v},w]$	(5) $y,\bar{x}+y,z [v,\bar{u}+v,w]$	(6) $x-y,x,z [u-v,u,w]$
	(7) $y,x,\bar{z} [v,u,\bar{w}]$	(8) $x-y,\bar{y},\bar{z} [u-v,\bar{v},\bar{w}]$	(9) $\bar{x},\bar{x}+y,\bar{z} [\bar{u},\bar{u}+v,\bar{w}]$
	(10) $\bar{y},\bar{x},\bar{z} [\bar{v},\bar{u},\bar{w}]$	(11) $\bar{x}+y,y,\bar{z} [\bar{u}+v,v,\bar{w}]$	(12) $x,x-y,\bar{z} [u,u-v,\bar{w}]$
	(13) $\bar{x},\bar{y},\bar{z} [u,v,w]$	(14) $y,\bar{x}+y,\bar{z} [\bar{v},u-v,w]$	(15) $x-y,x,\bar{z} [\bar{u}+v,\bar{u},w]$
	(16) $x,y,\bar{z} [\bar{u},\bar{v},w]$	(17) $\bar{y},x-y,\bar{z} [v,\bar{u}+v,w]$	(18) $\bar{x}+y,\bar{x},\bar{z} [u-v,u,w]$
	(19) $\bar{y},\bar{x},z [v,u,\bar{w}]$	(20) $\bar{x}+y,y,z [u-v,\bar{v},\bar{w}]$	(21) $x,x-y,z [\bar{u},\bar{u}+v,\bar{w}]$
	(22) $y,x,z [\bar{v},\bar{u},\bar{w}]$	(23) $x-y,\bar{y},z [\bar{u}+v,v,\bar{w}]$	(24) $\bar{x},\bar{x}+y,z [u,u-v,\bar{w}]$
12 k m'..	$x,y,1/2 [u,v,0]$	$\bar{y},x-y,1/2 [\bar{v},u-v,0]$	$\bar{x}+y,\bar{x},1/2 [\bar{u}+v,\bar{u},0]$
	$\bar{x},\bar{y},1/2 [\bar{u},\bar{v},0]$	$y,\bar{x}+y,1/2 [v,\bar{u}+v,0]$	$x-y,x,1/2 [u-v,u,0]$
	$y,x,1/2 [v,u,0]$	$x-y,\bar{y},1/2 [u-v,\bar{v},0]$	$\bar{x},\bar{x}+y,1/2 [\bar{u},\bar{u}+v,0]$
	$\bar{y},\bar{x},1/2 [\bar{v},\bar{u},0]$	$\bar{x}+y,y,1/2 [\bar{u}+v,v,0]$	$x,x-y,1/2 [u,u-v,0]$
12 j m..	$x,y,0 [0,0,w]$	$\bar{y},x-y,0 [0,0,w]$	$\bar{x}+y,\bar{x},0 [0,0,w]$
	$\bar{x},\bar{y},0 [0,0,w]$	$y,\bar{x}+y,0 [0,0,w]$	$x-y,x,0 [0,0,w]$
	$y,x,0 [0,0,\bar{w}]$	$x-y,\bar{y},0 [0,0,\bar{w}]$	$\bar{x},\bar{x}+y,0 [0,0,\bar{w}]$
	$\bar{y},\bar{x},0 [0,0,\bar{w}]$	$\bar{x}+y,y,0 [0,0,\bar{w}]$	$x,x-y,0 [0,0,\bar{w}]$

Continued

No. 73.10.378

 $p_{2c} \bar{6}/mmm$

12 i .m.	$x, 2x, z [u, 0, 0]$	$2\bar{x}, \bar{x}, z [0, u, 0]$	$x, \bar{x}, z [\bar{u}, \bar{u}, 0]$
	$\bar{x}, 2\bar{x}, z [\bar{u}, 0, 0]$	$2x, x, z [0, \bar{u}, 0]$	$\bar{x}, x, z [u, u, 0]$
	$2x, x, \bar{z} [0, u, 0]$	$\bar{x}, 2\bar{x}, \bar{z} [u, 0, 0]$	$\bar{x}, x, \bar{z} [\bar{u}, \bar{u}, 0]$
	$2\bar{x}, \bar{x}, \bar{z} [0, \bar{u}, 0]$	$x, 2x, \bar{z} [\bar{u}, 0, 0]$	$x, \bar{x}, \bar{z} [u, u, 0]$
12 h ..m	$x, 0, z [u, 2u, 0]$	$0, x, z [2\bar{u}, \bar{u}, 0]$	$\bar{x}, \bar{x}, z [u, \bar{u}, 0]$
	$\bar{x}, 0, z [\bar{u}, 2\bar{u}, 0]$	$0, \bar{x}, z [2u, u, 0]$	$x, x, z [\bar{u}, u, 0]$
	$0, x, \bar{z} [2u, u, 0]$	$x, 0, \bar{z} [\bar{u}, 2\bar{u}, 0]$	$\bar{x}, \bar{x}, \bar{z} [\bar{u}, u, 0]$
	$0, \bar{x}, \bar{z} [2\bar{u}, \bar{u}, 0]$	$\bar{x}, 0, \bar{z} [u, 2u, 0]$	$x, x, \bar{z} [u, \bar{u}, 0]$
6 g m'm2'	$x, 2x, 1/2 [u, 0, 0]$	$2\bar{x}, \bar{x}, 1/2 [0, u, 0]$	$x, \bar{x}, 1/2 [\bar{u}, \bar{u}, 0]$
	$\bar{x}, 2\bar{x}, 1/2 [\bar{u}, 0, 0]$	$2x, x, 1/2 [0, \bar{u}, 0]$	$\bar{x}, x, 1/2 [u, u, 0]$
6 f mm2	$x, 2x, 0 [0, 0, 0]$	$2\bar{x}, \bar{x}, 0 [0, 0, 0]$	$x, \bar{x}, 0 [0, 0, 0]$
	$\bar{x}, 2\bar{x}, 0 [0, 0, 0]$	$2x, x, 0 [0, 0, 0]$	$\bar{x}, x, 0 [0, 0, 0]$
6 e m'2'm	$x, 0, 1/2 [u, 2u, 0]$	$0, x, 1/2 [2\bar{u}, \bar{u}, 0]$	$\bar{x}, \bar{x}, 1/2 [u, \bar{u}, 0]$
	$\bar{x}, 0, 1/2 [\bar{u}, 2\bar{u}, 0]$	$0, \bar{x}, 1/2 [2u, u, 0]$	$x, x, 1/2 [\bar{u}, u, 0]$
6 d m2m	$x, 0, 0 [0, 0, 0]$	$0, x, 0 [0, 0, 0]$	$\bar{x}, \bar{x}, 0 [0, 0, 0]$
	$\bar{x}, 0, 0 [0, 0, 0]$	$0, \bar{x}, 0 [0, 0, 0]$	$x, x, 0 [0, 0, 0]$
2 c 6mm	$0, 0, z [0, 0, w]$	$0, 0, \bar{z} [0, 0, \bar{w}]$	
1 b 6/m'mm	$0, 0, 1/2 [0, 0, 0]$		
1 a 6/mmm	$0, 0, 0 [0, 0, 0]$		

Continued

No. 73.10.378

$p_{2c} 6/mmm$

Symmetry of special projections

Along [001] $6mm1'$

Origin at 0,0,z

Along [100] $p2mm1'$

$a^* = c$

Origin at x,0,0

Along [210] $p2mm1'$

$a^* = c$

Origin at x,x/2,0

$p6/mcc$

$6/mmm$

Hexagonal

No. 74.1.379

$p6/m2/c2/c$

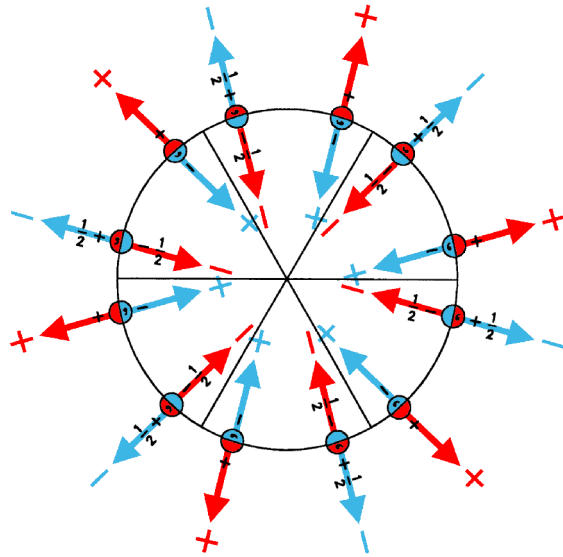
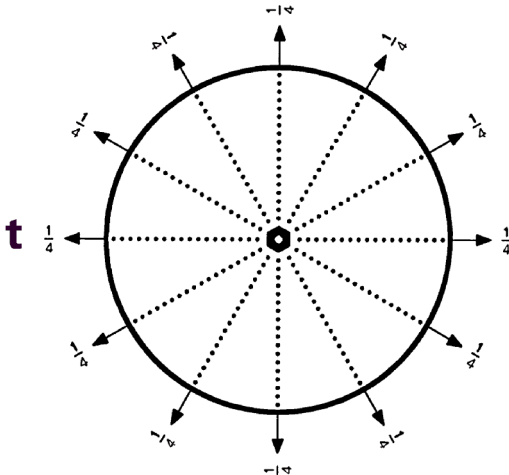

Origin at center ($6/m$) at $6/mcc$

Asymmetric unit $0 \leq x$; $0 \leq y$; $0 \leq z \leq 1/4$; $y \leq x$

Symmetry operations

- | | | |
|--|---|---|
| (1) 1
(1 0,0,0) | (2) 3^+ 0,0,z
(3_z 0,0,0) | (3) 3^- 0,0,z
(3_z^{-1} 0,0,0) |
| (4) 2 0,0,z
(2_z 0,0,0) | (5) 6^- 0,0,z
(6_z^{-1} 0,0,0) | (6) 6^+ 0,0,z
(6_z 0,0,0) |
| (7) 2 x,x,1/4
(2_{xy} 0,0,1/2) | (8) 2 x,0,1/4
(2_x 0,0,1/2) | (9) 2 0,y,1/4
(2_y 0,0,1/2) |
| (10) 2 x, \bar{x} ,1/4
(2_3 0,0,1/2) | (11) 2 x,2x,1/4
(2_2 0,0,1/2) | (12) 2 2x,x,1/4
(2_1 0,0,1/2) |
| (13) $\bar{1}$ 0,0,0
($\bar{1}$ 0,0,0) | (14) $\bar{3}^+$ 0,0,z; 0,0,0
($\bar{3}_z$ 0,0,0) | (15) $\bar{3}^-$ 0,0,z; 0,0,0
($\bar{3}_z^{-1}$ 0,0,0) |
| (16) m x,y,0
(m_z 0,0,0) | (17) $\bar{6}^-$ 0,0,z; 0,0,0
($\bar{6}_z^{-1}$ 0,0,0) | (18) $\bar{6}^+$ 0,0,z; 0,0,0
($\bar{6}_z$ 0,0,0) |
| (19) c (0,0,1/2) x, \bar{x} ,z
(m_{xy} 0,0,1/2) | (20) c (0,0,1/2) x,2x,z
(m_x 0,0,1/2) | (21) c (0,0,1/2) 2x,x,z
(m_y 0,0,1/2) |
| (22) c (0,0,1/2) x,x,z
(m_3 0,0,1/2) | (23) c (0,0,1/2) x,0,z
(m_2 0,0,1/2) | (24) c (0,0,1/2) 0,y,z
(m_1 0,0,1/2) |

Generators selected (1); t(0,0,1); (2); (4); (7); (13)

Positions

	Coordinates		
Multiplicity, Wyckoff letter, Site symmetry			
24 g 1	(1) x,y,z [u,v,w]	(2) $\bar{y},x-y,z$ [$\bar{v},u-v,w$]	(3) $\bar{x}+y,\bar{x},z$ [$\bar{u}+v,\bar{u},w$]
	(4) \bar{x},\bar{y},z [\bar{u},\bar{v},w]	(5) $y,\bar{x}+y,z$ [$v,\bar{u}+v,w$]	(6) $x-y,x,z$ [$u-v,u,w$]
	(7) $y,x,\bar{z}+1/2$ [v,u,\bar{w}]	(8) $x-y,\bar{y},\bar{z}+1/2$ [$u-v,\bar{v},\bar{w}$]	(9) $\bar{x},\bar{x}+y,\bar{z}+1/2$ [$\bar{u},\bar{u}+v,\bar{w}$]
	(10) $\bar{y},\bar{x},\bar{z}+1/2$ [\bar{v},\bar{u},\bar{w}]	(11) $\bar{x}+y,y,\bar{z}+1/2$ [$\bar{u}+v,v,\bar{w}$]	(12) $x,x-y,\bar{z}+1/2$ [$u,u-v,\bar{w}$]
	(13) \bar{x},\bar{y},\bar{z} [u,v,w]	(14) $y,\bar{x}+y,\bar{z}$ [$\bar{v},u-v,w$]	(15) $x-y,x,\bar{z}$ [$\bar{u}+v,\bar{u},w$]
	(16) x,y,\bar{z} [\bar{u},\bar{v},w]	(17) $\bar{y},x-y,\bar{z}$ [$v,\bar{u}+v,w$]	(18) $\bar{x}+y,\bar{x},\bar{z}$ [$u-v,u,w$]
	(19) $\bar{y},\bar{x},z+1/2$ [v,u,\bar{w}]	(20) $\bar{x}+y,y,z+1/2$ [$u-v,\bar{v},\bar{w}$]	(21) $x,x-y,z+1/2$ [$\bar{u},\bar{u}+v,\bar{w}$]
	(22) $y,x,z+1/2$ [\bar{v},\bar{u},\bar{w}]	(23) $x-y,\bar{y},z+1/2$ [$\bar{u}+v,v,\bar{w}$]	(24) $\bar{x},\bar{x}+y,z+1/2$ [$u,u-v,\bar{w}$]
12 f m..	$x,y,0$ [0,0,w]	$\bar{y},x-y,0$ [0,0,w]	$\bar{x}+y,\bar{x},0$ [0,0,w]
	$\bar{x},\bar{y},0$ [0,0,w]	$y,\bar{x}+y,0$ [0,0,w]	$x-y,x,0$ [0,0,w]
	$y,x,1/2$ [0,0, \bar{w}]	$x-y,\bar{y},1/2$ [0,0, \bar{w}]	$\bar{x},\bar{x}+y,1/2$ [0,0, \bar{w}]
	$\bar{y},\bar{x},1/2$ [0,0, \bar{w}]	$\bar{x}+y,y,1/2$ [0,0, \bar{w}]	$x,x-y,1/2$ [0,0, \bar{w}]
12 e ..2	$x,2x,1/4$ [u,2u,0]	$2\bar{x},\bar{x},1/4$ [2 $\bar{u},\bar{u},0$]	$x,\bar{x},1/4$ [u, $\bar{u},0$]
	$\bar{x},2\bar{x},1/4$ [$\bar{u},2\bar{u},0$]	$2x,x,1/4$ [2u,u,0]	$\bar{x},x,1/4$ [$\bar{u},u,0$]
	$2x,x,3/4$ [2 $\bar{u},\bar{u},0$]	$\bar{x},2\bar{x},3/4$ [u,2u,0]	$\bar{x},x,3/4$ [u, $\bar{u},0$]
	$2\bar{x},\bar{x},3/4$ [2u,u,0]	$x,2x,3/4$ [$\bar{u},2\bar{u},0$]	$x,\bar{x},3/4$ [$\bar{u},u,0$]

Continued

No. 74.1.379

p6/mcc

12 d .2.	x,0,1/4 [u,0,0]	0,x,1/4 [0,u,0]	$\bar{x},\bar{x},1/4 [\bar{u},\bar{u},0]$
	$\bar{x},0,1/4 [\bar{u},0,0]$	0, $\bar{x},1/4 [0,\bar{u},0]$	x,x,1/4 [u,u,0]
	$\bar{x},0,3/4 [u,0,0]$	0, $\bar{x},3/4 [0,u,0]$	x,x,3/4 [$\bar{u},\bar{u},0$]
	x,0,3/4 [$\bar{u},0,0$]	0,x,3/4 [0, $\bar{u},0$]	$\bar{x},\bar{x},3/4 [u,u,0]$
4 c 6..	0,0,z [0,0,w]	0,0, $\bar{z}+1/2 [0,0,\bar{w}]$	
	0,0, $\bar{z} [0,0,w]$	0,0,z+1/2 [0,0, $\bar{w}]$	
2 b 6/m..	0,0,0 [0,0,w]	0,0,1/2 [0,0, $\bar{w}]$	
2 a 622	0,0,1/4 [0,0,0]	0,0,3/4 [0,0,0]	

Symmetry of special projections

Along [001] 6mm	Along [100] $p_{2a^*}2'mm'$	Along [210] $p_{2a^*}2'mm'$
Origin at 0,0,z	$a^* = c/2$ Origin at x,0,0	$a^* = c/2$ Origin at x,x/2,0

$p6/mcc1'$

$6/mmm1'$

Hexagonal

No. 74.2.380

$p6/m2/c2/c1'$

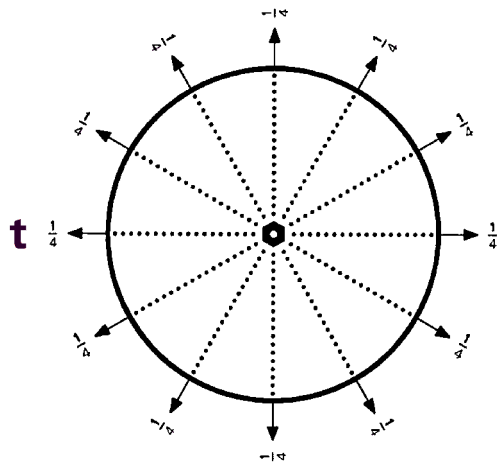

1'

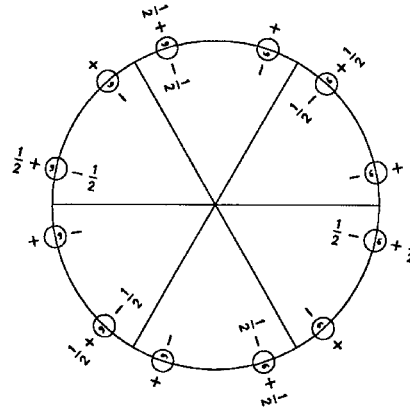

Origin at center ($6/m1'$) at $6/mcc1'$

Asymmetric unit $0 \leq x$; $0 \leq y$; $0 \leq z \leq 1/4$; $y \leq x$

Symmetry operations

For 1 + set

- | | | |
|--|---|---|
| (1) 1
(1 0,0,0) | (2) 3^+ 0,0,z
(3_z 0,0,0) | (3) 3^- 0,0,z
(3_z^{-1} 0,0,0) |
| (4) 2 0,0,z
(2_z 0,0,0) | (5) 6^- 0,0,z
(6_z^{-1} 0,0,0) | (6) 6^+ 0,0,z
(6_z 0,0,0) |
| (7) 2 x,x,1/4
(2_{xy} 0,0,1/2) | (8) 2 x,0,1/4
(2_x 0,0,1/2) | (9) 2 0,y,1/4
(2_y 0,0,1/2) |
| (10) 2 x, \bar{x} ,1/4
(2_3 0,0,1/2) | (11) 2 x,2x,1/4
(2_2 0,0,1/2) | (12) 2 2x,x,1/4
(2_1 0,0,1/2) |
| (13) $\bar{1}$ 0,0,0
($\bar{1}$ 0,0,0) | (14) $\bar{3}^+$ 0,0,z; 0,0,0
($\bar{3}_z$ 0,0,0) | (15) $\bar{3}^-$ 0,0,z; 0,0,0
($\bar{3}_z^{-1}$ 0,0,0) |
| (16) m x,y,0
(m_z 0,0,0) | (17) $\bar{6}^-$ 0,0,z; 0,0,0
($\bar{6}_z^{-1}$ 0,0,0) | (18) $\bar{6}^+$ 0,0,z; 0,0,0
($\bar{6}_z$ 0,0,0) |
| (19) c (0,0,1/2) x, \bar{x} ,z
(m_{xy} 0,0,1/2) | (20) c (0,0,1/2) x,2x,z
(m_x 0,0,1/2) | (21) c (0,0,1/2) 2x,x,z
(m_y 0,0,1/2) |
| (22) c (0,0,1/2) x,x,z
(m_3 0,0,1/2) | (23) c (0,0,1/2) x,0,z
(m_2 0,0,1/2) | (24) c (0,0,1/2) 0,y,z
(m_1 0,0,1/2) |

For 1' + set

- | | | |
|---|--|--|
| (1) 1'
(1 0,0,0)' | (2) 3 ⁺ ' 0,0,z
(3 _z ⁻¹ 0,0,0)' | (3) 3 ⁻ ' 0,0,z
(3 _z ⁻¹ 0,0,0)' |
| (4) 2' 0,0,z
(2 _z 0,0,0)' | (5) 6 ⁻ ' 0,0,z
(6 _z ⁻¹ 0,0,0)' | (6) 6 ⁺ ' 0,0,z
(6 _z 0,0,0)' |
| (7) 2' x,x,1/4
(2 _{xy} 0,0,1/2)' | (8) 2' x,0,1/4
(2 _x 0,0,1/2)' | (9) 2' 0,y,1/4
(2 _y 0,0,1/2)' |
| (10) 2' x,x̄,1/4
(2 ₃ 0,0,1/2)' | (11) 2' x,2x,1/4
(2 ₂ 0,0,1/2)' | (12) 2' 2x,x,1/4
(2 ₁ 0,0,1/2)' |
| (13) 1̄' 0,0,0
(1̄ 0,0,0)' | (14) 3̄ ⁺ ' 0,0,z; 0,0,0
(3̄ _z 0,0,0)' | (15) 3̄ ⁻ ' 0,0,z; 0,0,0
(3̄ _z ⁻¹ 0,0,0)' |
| (16) m' x,y,0
(m _z 0,0,0)' | (17) 6̄ ⁻ ' 0,0,z; 0,0,0
(6̄ _z ⁻¹ 0,0,0)' | (18) 6̄ ⁺ ' 0,0,z; 0,0,0
(6̄ _z 0,0,0)' |
| (19) c' (0,0,1/2) x,x̄,z
(m _{xy} 0,0,1/2)' | (20) c' (0,0,1/2) x,2x,z
(m _x 0,0,1/2)' | (21) c' (0,0,1/2) 2x,x,z
(m _y 0,0,1/2)' |
| (22) c' (0,0,1/2) x,x,z
(m ₃ 0,0,1/2)' | (23) c' (0,0,1/2) x,0,z
(m ₂ 0,0,1/2)' | (24) c' (0,0,1/2) 0,y,z
(m ₁ 0,0,1/2)' |

Generators selected (1); t(0,0,1); (2); (4); (7); (13); 1'

Positions

Multiplicity, Wyckoff letter, Site symmetry	Coordinates		
	1+	1' +	
24 g 11'	(1) x,y,z [0,0,0]	(2) $\bar{y},x-y,z$ [0,0,0]	(3) $\bar{x}+y,\bar{x},z$ [0,0,0]
	(4) \bar{x},\bar{y},z [0,0,0]	(5) $y,\bar{x}+y,z$ [0,0,0]	(6) x-y,x,z [0,0,0]
	(7) y,x, $\bar{z}+1/2$ [0,0,0]	(8) x-y, $\bar{y},\bar{z}+1/2$ [0,0,0]	(9) $\bar{x},\bar{x}+y,\bar{z}+1/2$ [0,0,0]
	(10) $\bar{y},\bar{x},\bar{z}+1/2$ [0,0,0]	(11) $\bar{x}+y,y,\bar{z}+1/2$ [0,0,0]	(12) x,x-y, $\bar{z}+1/2$ [0,0,0]
	(13) \bar{x},\bar{y},\bar{z} [0,0,0]	(14) $y,\bar{x}+y,\bar{z}$ [0,0,0]	(15) x-y,x, \bar{z} [0,0,0]
	(16) x,y, \bar{z} [0,0,0]	(17) $\bar{y},x-y,\bar{z}$ [0,0,0]	(18) $\bar{x}+y,\bar{x},\bar{z}$ [0,0,0]
	(19) $\bar{y},\bar{x},z+1/2$ [0,0,0]	(20) $\bar{x}+y,y,z+1/2$ [0,0,0]	(21) x,x-y,z+1/2 [0,0,0]
	(22) y,x,z+1/2 [0,0,0]	(23) x-y, $\bar{y},z+1/2$ [0,0,0]	(24) $\bar{x},\bar{x}+y,z+1/2$ [0,0,0]
12 f m..1'	x,y,0 [0,0,0]	$\bar{y},x-y,0$ [0,0,0]	$\bar{x}+y,\bar{x},0$ [0,0,0]
	$\bar{x},\bar{y},0$ [0,0,0]	y, $\bar{x}+y,0$ [0,0,0]	x-y,x,0 [0,0,0]
	y,x,1/2 [0,0,0]	x-y, $\bar{y},1/2$ [0,0,0]	$\bar{x},\bar{x}+y,1/2$ [0,0,0]
	$\bar{y},\bar{x},1/2$ [0,0,0]	$\bar{x}+y,y,1/2$ [0,0,0]	x,x-y,1/2 [0,0,0]
12 e ..21'	x,2x,1/4 [0,0,0]	2 $\bar{x},\bar{x},1/4$ [0,0,0]	x, $\bar{x},1/4$ [0,0,0]
	$\bar{x},2\bar{x},1/4$ [0,0,0]	2x,x,1/4 [0,0,0]	$\bar{x},x,1/4$ [0,0,0]
	2x,x,3/4 [0,0,0]	$\bar{x},2\bar{x},3/4$ [0,0,0]	$\bar{x},x,3/4$ [0,0,0]
	2 $\bar{x},\bar{x},3/4$ [0,0,0]	x,2x,3/4 [0,0,0]	x, $\bar{x},3/4$ [0,0,0]

Continued

No. 74.2.380

 $p6/mcc1'$

12 d	.2.1'	$x, 0, 1/4 [0, 0, 0]$	$0, x, 1/4 [0, 0, 0]$	$\bar{x}, \bar{x}, 1/4 [0, 0, 0]$
		$\bar{x}, 0, 1/4 [0, 0, 0]$	$0, \bar{x}, 1/4 [0, 0, 0]$	$x, x, 1/4 [0, 0, 0]$
		$\bar{x}, 0, 3/4 [0, 0, 0]$	$0, \bar{x}, 3/4 [0, 0, 0]$	$x, x, 3/4 [0, 0, 0]$
		$x, 0, 3/4 [0, 0, 0]$	$0, x, 3/4 [0, 0, 0]$	$\bar{x}, \bar{x}, 3/4 [0, 0, 0]$
4 c	6..1'	$0, 0, z [0, 0, 0]$	$0, 0, \bar{z} + 1/2 [0, 0, 0]$	
		$0, 0, \bar{z} [0, 0, 0]$	$0, 0, z + 1/2 [0, 0, 0]$	
2 b	6/m..1'	$0, 0, 0 [0, 0, 0]$	$0, 0, 1/2 [0, 0, 0]$	
2 a	6221'	$0, 0, 1/4 [0, 0, 0]$	$0, 0, 3/4 [0, 0, 0]$	

Symmetry of special projectionsAlong [001] $6mm1'$ Origin at $0, 0, z$ Along [100] $p2mm1'$ $a^* = c/2$ Origin at $x, 0, 0$ Along [210] $p2mm1'$ $a^* = c/2$ Origin at $x, x/2, 0$

$p6/m'c'c'$

$6/m'm'm'$

Hexagonal

No. 74.3.381

$p6/m'2/c'2/c'$

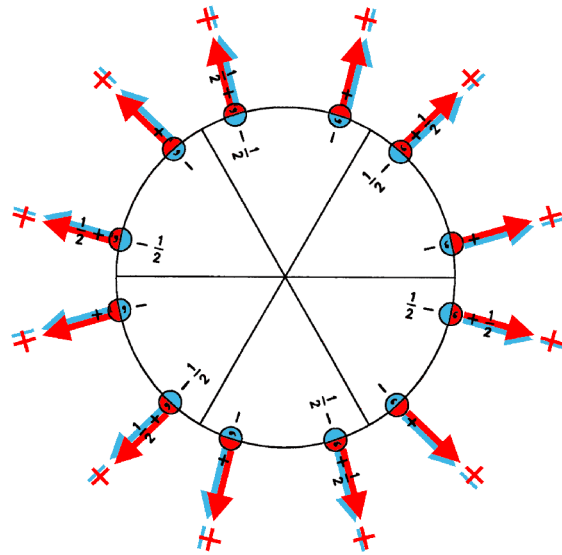
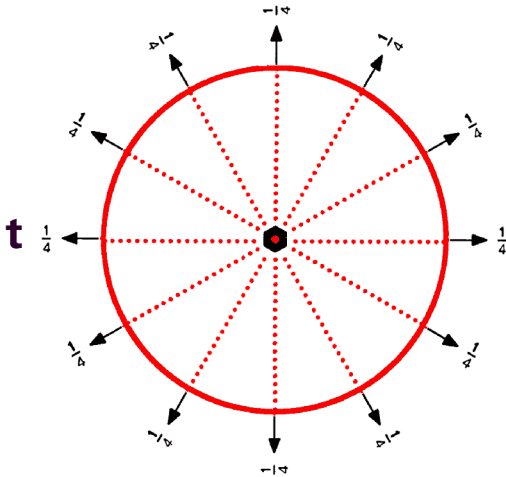

Origin at center ($6/m'$) at $6/m'c'c'$

Asymmetric unit $0 \leq x$; $0 \leq y$; $0 \leq z \leq 1/4$; $y \leq x$

Symmetry operations

- | | | |
|--|--|--|
| (1) 1
(1 0,0,0) | (2) 3^+ 0,0,z
(3_z 0,0,0) | (3) 3^- 0,0,z
(3_z^{-1} 0,0,0) |
| (4) 2 0,0,z
(2_z 0,0,0) | (5) 6^- 0,0,z
(6_z^{-1} 0,0,0) | (6) 6^+ 0,0,z
(6_z 0,0,0) |
| (7) 2 x,x,1/4
(2_{xy} 0,0,1/2) | (8) 2 x,0,1/4
(2_x 0,0,1/2) | (9) 2 0,y,1/4
(2_y 0,0,1/2) |
| (10) 2 x, \bar{x} ,1/4
(2_3 0,0,1/2) | (11) 2 x,2x,1/4
(2_2 0,0,1/2) | (12) 2 2x,x,1/4
(2_1 0,0,1/2) |
| (13) $\bar{1}$ 0,0,0
($\bar{1}$ 0,0,0)' | (14) $\bar{3}^+$ 0,0,z; 0,0,0
($\bar{3}_z$ 0,0,0)' | (15) $\bar{3}^-$ 0,0,z; 0,0,0
($\bar{3}_z^{-1}$ 0,0,0)' |
| (16) m' x,y,0
(m_z 0,0,0)' | (17) $\bar{6}^-$ 0,0,z; 0,0,0
($\bar{6}_z^{-1}$ 0,0,0)' | (18) $\bar{6}^+$ 0,0,z; 0,0,0
($\bar{6}_z$ 0,0,0)' |
| (19) c' (0,0,1/2) x, \bar{x} ,z
(m_{xy} 0,0,1/2)' | (20) c' (0,0,1/2) x,2x,z
(m_x 0,0,1/2)' | (21) c' (0,0,1/2) 2x,x,z
(m_y 0,0,1/2)' |
| (22) c' (0,0,1/2) x,x,z
(m_3 0,0,1/2)' | (23) c' (0,0,1/2) x,0,z
(m_2 0,0,1/2)' | (24) c' (0,0,1/2) 0,y,z
(m_1 0,0,1/2)' |

Generators selected (1); t(0,0,1); (2); (4); (7); (13)

Positions

	Coordinates		
Multiplicity, Wyckoff letter, Site symmetry			
24 g 1	(1) x,y,z [u,v,w]	(2) $\bar{y},x-y,z$ [$\bar{v},u-v,w$]	(3) $\bar{x}+y,\bar{x},z$ [$\bar{u}+v,\bar{u},w$]
	(4) \bar{x},\bar{y},z [\bar{u},\bar{v},w]	(5) $y,\bar{x}+y,z$ [$v,\bar{u}+v,w$]	(6) $x-y,x,z$ [u-v,u,w]
	(7) $y,x,\bar{z}+1/2$ [v,u, \bar{w}]	(8) $x-y,\bar{y},\bar{z}+1/2$ [u-v, \bar{v},\bar{w}]	(9) $\bar{x},\bar{x}+y,\bar{z}+1/2$ [$\bar{u},\bar{u}+v,\bar{w}$]
	(10) $\bar{y},\bar{x},\bar{z}+1/2$ [\bar{v},\bar{u},\bar{w}]	(11) $\bar{x}+y,y,\bar{z}+1/2$ [$\bar{u}+v,v,\bar{w}$]	(12) $x,x-y,\bar{z}+1/2$ [u,u-v, \bar{w}]
	(13) \bar{x},\bar{y},\bar{z} [\bar{u},\bar{v},\bar{w}]	(14) $y,\bar{x}+y,\bar{z}$ [$v,\bar{u}+v,\bar{w}$]	(15) $x-y,x,\bar{z}$ [u-v,u, \bar{w}]
	(16) x,y,\bar{z} [u,v, \bar{w}]	(17) $\bar{y},x-y,\bar{z}$ [$\bar{v},u-v,\bar{w}$]	(18) $\bar{x}+y,\bar{x},\bar{z}$ [$\bar{u}+v,\bar{u},\bar{w}$]
	(19) $\bar{y},\bar{x},z+1/2$ [\bar{v},\bar{u},w]	(20) $\bar{x}+y,y,z+1/2$ [$\bar{u}+v,v,w$]	(21) $x,x-y,z+1/2$ [u,u-v,w]
	(22) $y,x,z+1/2$ [v,u,w]	(23) $x-y,\bar{y},z+1/2$ [u-v, \bar{v},w]	(24) $\bar{x},\bar{x}+y,z+1/2$ [$\bar{u},\bar{u}+v,w$]
12 f m'..	$x,y,0$ [u,v,0]	$\bar{y},x-y,0$ [$\bar{v},u-v,0$]	$\bar{x}+y,\bar{x},0$ [$\bar{u}+v,\bar{u},0$]
	$\bar{x},\bar{y},0$ [$\bar{u},\bar{v},0$]	$y,\bar{x}+y,0$ [$v,\bar{u}+v,0$]	$x-y,x,0$ [u-v,u,0]
	$y,x,1/2$ [v,u,0]	$x-y,\bar{y},1/2$ [u-v, $\bar{v},0$]	$\bar{x},\bar{x}+y,1/2$ [$\bar{u},\bar{u}+v,0$]
	$\bar{y},\bar{x},1/2$ [$\bar{v},\bar{u},0$]	$\bar{x}+y,y,1/2$ [$\bar{u}+v,v,0$]	$x,x-y,1/2$ [u,u-v,0]
12 e ..2	$x,2x,1/4$ [u,2u,0]	$2\bar{x},\bar{x},1/4$ [$2\bar{u},\bar{u},0$]	$x,\bar{x},1/4$ [u, $\bar{u},0$]
	$\bar{x},2\bar{x},1/4$ [$\bar{u},2\bar{u},0$]	$2x,x,1/4$ [2u,u,0]	$\bar{x},x,1/4$ [$\bar{u},u,0$]
	$2x,x,3/4$ [2u,u,0]	$\bar{x},2\bar{x},3/4$ [$\bar{u},2\bar{u},0$]	$\bar{x},x,3/4$ [$\bar{u},u,0$]
	$2\bar{x},\bar{x},3/4$ [$2\bar{u},\bar{u},0$]	$x,2x,3/4$ [u,2u,0]	$x,\bar{x},3/4$ [u, $\bar{u},0$]

Continued

No. 74.3.381

 $p6/m'c'$

12 d .2.	$x,0,1/4 [u,0,0]$	$0,x,1/4 [0,u,0]$	$\bar{x},\bar{x},1/4 [\bar{u},\bar{u},0]$
	$\bar{x},0,1/4 [\bar{u},0,0]$	$0,\bar{x},1/4 [0,\bar{u},0]$	$x,x,1/4 [u,u,0]$
	$\bar{x},0,3/4 [\bar{u},0,0]$	$0,\bar{x},3/4 [0,\bar{u},0]$	$x,x,3/4 [u,u,0]$
	$x,0,3/4 [u,0,0]$	$0,x,3/4 [0,u,0]$	$\bar{x},\bar{x},3/4 [\bar{u},\bar{u},0]$
4 c 6..	$0,0,z [0,0,w]$	$0,0,\bar{z}+1/2 [0,0,\bar{w}]$	
	$0,0,\bar{z} [0,0,\bar{w}]$	$0,0,z+1/2 [0,0,w]$	
2 b $6/m'..$	$0,0,0 [0,0,0]$	$0,0,1/2 [0,0,0]$	
2 a 622	$0,0,1/4 [0,0,0]$	$0,0,3/4 [0,0,0]$	

Symmetry of special projectionsAlong [001] $6mm1'$ Origin at $0,0,z$ Along [100] $p2m'm'$ $a^* = c/2$ Origin at $x,0,0$ Along [210] $p2m'm'$ $a^* = c/2$ Origin at $x,x/2,0$

$p6/mc'c'$

$6/m\bar{m}'m'$

Hexagonal

No. 74.4.382

$p6/m2'c'2'/c'$

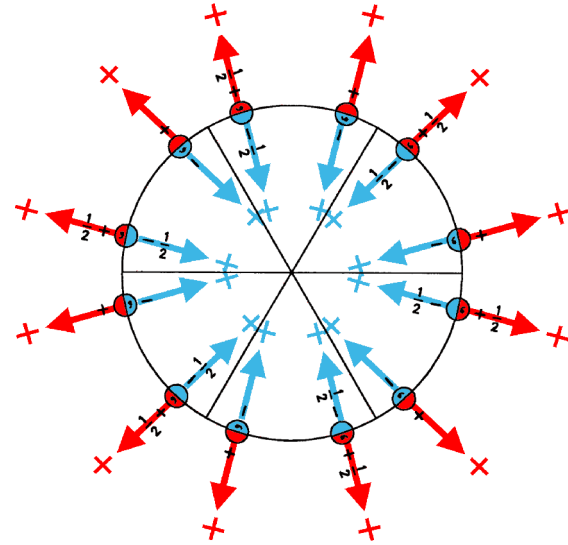
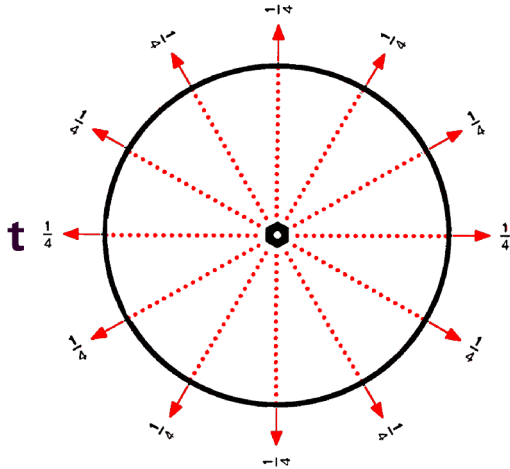

Origin at center ($6/m$) at $6/mc'c'$

Asymmetric unit $0 \leq x$; $0 \leq y$; $0 \leq z \leq 1/4$; $y \leq x$

Symmetry operations

- | | | |
|--|---|---|
| (1) 1
(1 0,0,0) | (2) 3^+ 0,0,z
(3_z 0,0,0) | (3) 3^- 0,0,z
(3_z^{-1} 0,0,0) |
| (4) 2 0,0,z
(2_z 0,0,0) | (5) 6^- 0,0,z
(6_z^{-1} 0,0,0) | (6) 6^+ 0,0,z
(6_z 0,0,0) |
| (7) $2'$ x,x,1/4
(2_{xy} 0,0,1/2)' | (8) $2'$ x,0,1/4
(2_x 0,0,1/2)' | (9) $2'$ 0,y,1/4
(2_y 0,0,1/2)' |
| (10) $2'$ x, \bar{x} ,1/4
(2_3 0,0,1/2)' | (11) $2'$ x,2x,1/4
(2_2 0,0,1/2)' | (12) $2'$ 2x,x,1/4
(2_1 0,0,1/2)' |
| (13) $\bar{1}$ 0,0,0
($\bar{1}$ 0,0,0) | (14) $\bar{3}^+$ 0,0,z; 0,0,0
($\bar{3}_z$ 0,0,0) | (15) $\bar{3}^-$ 0,0,z; 0,0,0
($\bar{3}_z^{-1}$ 0,0,0) |
| (16) m x,y,0
(m_z 0,0,0) | (17) $\bar{6}^-$ 0,0,z; 0,0,0
($\bar{6}_z^{-1}$ 0,0,0) | (18) $\bar{6}^+$ 0,0,z; 0,0,0
($\bar{6}_z$ 0,0,0) |
| (19) c' (0,0,1/2) x, \bar{x} ,z
(m_{xy} 0,0,1/2)' | (20) c' (0,0,1/2) x,2x,z
(m_x 0,0,1/2)' | (21) c' (0,0,1/2) 2x,x,z
(m_y 0,0,1/2)' |
| (22) c' (0,0,1/2) x,x,z
(m_3 0,0,1/2)' | (23) c' (0,0,1/2) x,0,z
(m_2 0,0,1/2)' | (24) c' (0,0,1/2) 0,y,z
(m_1 0,0,1/2)' |

Generators selected (1); t(0,0,1); (2); (4); (7); (13)

Positions

Multiplicity, Wyckoff letter, Site symmetry	Coordinates		
	(1)	(2)	(3)
24 g 1	(1) x, y, z [u,v,w]	(2) $\bar{y}, x-y, z$ [$\bar{v}, u-v, w$]	(3) $\bar{x}+y, \bar{x}, z$ [$\bar{u}+v, \bar{u}, w$]
	(4) \bar{x}, \bar{y}, z [\bar{u}, \bar{v}, w]	(5) $y, \bar{x}+y, z$ [$v, \bar{u}+v, w$]	(6) $x-y, x, z$ [$u-v, u, w$]
	(7) $y, x, \bar{z}+1/2$ [\bar{v}, \bar{u}, w]	(8) $x-y, \bar{y}, \bar{z}+1/2$ [$\bar{u}+v, v, w$]	(9) $\bar{x}, \bar{x}+y, \bar{z}+1/2$ [$u, u-v, w$]
	(10) $\bar{y}, \bar{x}, \bar{z}+1/2$ [v, u, w]	(11) $\bar{x}+y, y, \bar{z}+1/2$ [$u-v, \bar{v}, w$]	(12) $x, x-y, \bar{z}+1/2$ [$\bar{u}, \bar{u}+v, w$]
	(13) $\bar{x}, \bar{y}, \bar{z}$ [u,v,w]	(14) $y, \bar{x}+y, \bar{z}$ [$\bar{v}, u-v, w$]	(15) $x-y, x, \bar{z}$ [$\bar{u}+v, \bar{u}, w$]
	(16) x, y, \bar{z} [\bar{u}, \bar{v}, w]	(17) $\bar{y}, x-y, \bar{z}$ [$v, \bar{u}+v, w$]	(18) $\bar{x}+y, \bar{x}, \bar{z}$ [$u-v, u, w$]
	(19) $\bar{y}, \bar{x}, z+1/2$ [\bar{v}, \bar{u}, w]	(20) $\bar{x}+y, y, z+1/2$ [$\bar{u}+v, v, w$]	(21) $x, x-y, z+1/2$ [$u, u-v, w$]
(22) $y, x, z+1/2$ [v, u, w]	(23) $x-y, \bar{y}, z+1/2$ [$u-v, \bar{v}, w$]	(24) $\bar{x}, \bar{x}+y, z+1/2$ [$\bar{u}, \bar{u}+v, w$]	
12 f m..	$x, y, 0$ [0,0,w]	$\bar{y}, x-y, 0$ [0,0,w]	$\bar{x}+y, \bar{x}, 0$ [0,0,w]
	$\bar{x}, \bar{y}, 0$ [0,0,w]	$y, \bar{x}+y, 0$ [0,0,w]	$x-y, x, 0$ [0,0,w]
	$y, x, 1/2$ [0,0,w]	$x-y, \bar{y}, 1/2$ [0,0,w]	$\bar{x}, \bar{x}+y, 1/2$ [0,0,w]
	$\bar{y}, \bar{x}, 1/2$ [0,0,w]	$\bar{x}+y, y, 1/2$ [0,0,w]	$x, x-y, 1/2$ [0,0,w]
12 e ..2'	$x, 2x, 1/4$ [u,0,w]	$2\bar{x}, \bar{x}, 1/4$ [0,u,w]	$x, \bar{x}, 1/4$ [\bar{u}, \bar{u}, w]
	$\bar{x}, 2\bar{x}, 1/4$ [$\bar{u}, 0, w$]	$2x, x, 1/4$ [0, \bar{u}, w]	$\bar{x}, x, 1/4$ [u,u,w]
	$2x, x, 3/4$ [0,u,w]	$\bar{x}, 2\bar{x}, 3/4$ [u,0,w]	$\bar{x}, x, 3/4$ [\bar{u}, \bar{u}, w]
	$2\bar{x}, \bar{x}, 3/4$ [0, \bar{u}, w]	$x, 2x, 3/4$ [$\bar{u}, 0, w$]	$x, \bar{x}, 3/4$ [u,u,w]

Continued

No. 74.4.382

 $p6/mc'c'$

12 d .2'	$x,0,1/4 [u,2u,w]$	$0,x,1/4 [2\bar{u},\bar{u},w]$	$\bar{x},\bar{x},1/4 [u,\bar{u},w]$
	$\bar{x},0,1/4 [\bar{u},2\bar{u},w]$	$0,\bar{x},1/4 [2u,u,w]$	$x,x,1/4 [\bar{u},u,w]$
	$\bar{x},0,3/4 [u,2u,w]$	$0,\bar{x},3/4 [2\bar{u},\bar{u},w]$	$x,x,3/4 [u,\bar{u},w]$
	$x,0,3/4 [\bar{u},2\bar{u},w]$	$0,x,3/4 [2u,u,w]$	$\bar{x},\bar{x},3/4 [\bar{u},u,w]$
4 c 6..	$0,0,z [0,0,w]$	$0,0,\bar{z}+1/2 [0,0,w]$	
	$0,0,\bar{z} [0,0,w]$	$0,0,z+1/2 [0,0,w]$	
2 b 6/m..	$0,0,0 [0,0,w]$	$0,0,1/2 [0,0,w]$	
2 a 62'2'	$0,0,1/4 [0,0,w]$	$0,0,3/4 [0,0,w]$	

Symmetry of special projectionsAlong [001] $6m'm'$

Origin at 0,0,z

Along [100] $p2'mm'$ $a^* = c/2$

Origin at x,0,0

Along [210] $p2'mm'$ $a^* = c/2$

Origin at x,x/2,0

$p6/m'cc$

$6/m'mm$

Hexagonal

No. 74.5.383

$p6/m'2'c2'/c$

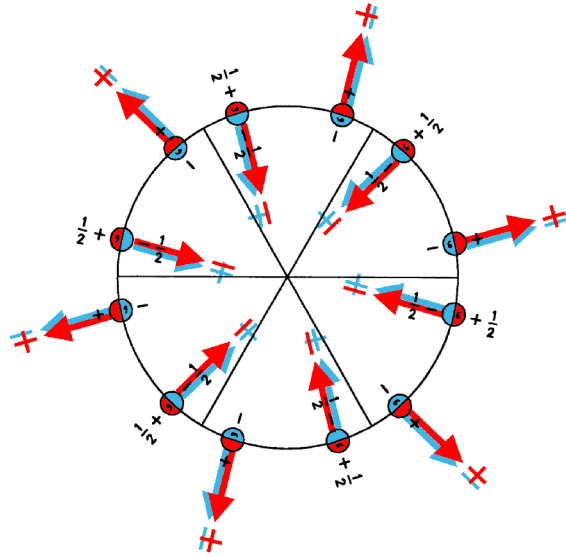
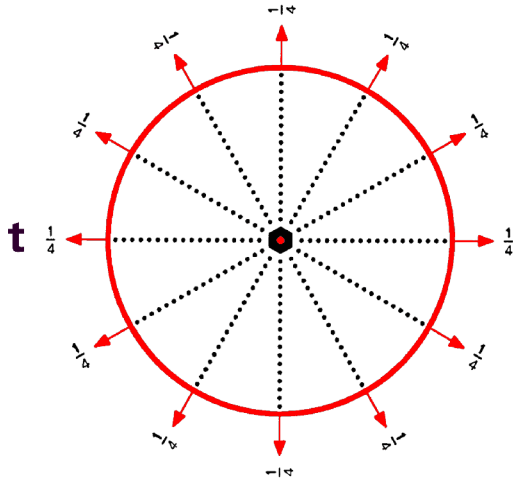

Origin at center ($6/m'$) at $6/m'cc$

Asymmetric unit $0 \leq x$; $0 \leq y$; $0 \leq z \leq 1/4$; $y \leq x$

Symmetry operations

- | | | |
|--|--|--|
| (1) 1
(1 0,0,0) | (2) 3^+ 0,0,z
(3_z 0,0,0) | (3) 3^- 0,0,z
(3_z^{-1} 0,0,0) |
| (4) 2 0,0,z
(2_z 0,0,0) | (5) 6^- 0,0,z
(6_z^{-1} 0,0,0) | (6) 6^+ 0,0,z
(6_z 0,0,0) |
| (7) $2'$ x,x,1/4
(2_{xy} 0,0,1/2)' | (8) $2'$ x,0,1/4
(2_x 0,0,1/2)' | (9) $2'$ 0,y,1/4
(2_y 0,0,1/2)' |
| (10) $2'$ x, \bar{x} ,1/4
(2_3 0,0,1/2)' | (11) $2'$ x,2x,1/4
(2_2 0,0,1/2)' | (12) $2'$ 2x,x,1/4
(2_1 0,0,1/2)' |
| (13) $\bar{1}$ 0,0,0
($\bar{1}$ 0,0,0)' | (14) $\bar{3}^+$ 0,0,z; 0,0,0
($\bar{3}_z$ 0,0,0)' | (15) $\bar{3}^-$ 0,0,z; 0,0,0
($\bar{3}_z^{-1}$ 0,0,0)' |
| (16) m' x,y,0
(m_z 0,0,0)' | (17) $\bar{6}^-$ 0,0,z; 0,0,0
($\bar{6}_z^{-1}$ 0,0,0)' | (18) $\bar{6}^+$ 0,0,z; 0,0,0
($\bar{6}_z$ 0,0,0)' |
| (19) c (0,0,1/2) x, \bar{x} ,z
(m_{xy} 0,0,1/2) | (20) c (0,0,1/2) x,2x,z
(m_x 0,0,1/2) | (21) c (0,0,1/2) 2x,x,z
(m_y 0,0,1/2) |
| (22) c (0,0,1/2) x,x,z
(m_3 0,0,1/2) | (23) c (0,0,1/2) x,0,z
(m_2 0,0,1/2) | (24) c (0,0,1/2) 0,y,z
(m_1 0,0,1/2) |

Generators selected (1); t(0,0,1); (2); (4); (7); (13)

Positions

	Coordinates		
Multiplicity, Wyckoff letter, Site symmetry			
24 g 1	(1) x,y,z [u,v,w]	(2) $\bar{y},x-y,z$ [$\bar{v},u-v,w$]	(3) $\bar{x}+y,\bar{x},z$ [$\bar{u}+v,\bar{u},w$]
	(4) \bar{x},\bar{y},z [\bar{u},\bar{v},w]	(5) $y,\bar{x}+y,z$ [$v,\bar{u}+v,w$]	(6) x-y,x,z [u-v,u,w]
	(7) y,x, $\bar{z}+1/2$ [\bar{v},\bar{u},w]	(8) x-y, $\bar{y},\bar{z}+1/2$ [$\bar{u}+v,v,w$]	(9) $\bar{x},\bar{x}+y,\bar{z}+1/2$ [u,u-v,w]
	(10) $\bar{y},\bar{x},\bar{z}+1/2$ [v,u,w]	(11) $\bar{x}+y,y,\bar{z}+1/2$ [u-v, \bar{v},w]	(12) x,x-y, $\bar{z}+1/2$ [$\bar{u},\bar{u}+v,w$]
	(13) \bar{x},\bar{y},\bar{z} [\bar{u},\bar{v},\bar{w}]	(14) $y,\bar{x}+y,\bar{z}$ [v, $\bar{u}+v,\bar{w}$]	(15) x-y,x, \bar{z} [u-v,u, \bar{w}]
	(16) x,y, \bar{z} [u,v, \bar{w}]	(17) $\bar{y},x-y,\bar{z}$ [$\bar{v},u-v,\bar{w}$]	(18) $\bar{x}+y,\bar{x},\bar{z}$ [$\bar{u}+v,\bar{u},\bar{w}$]
	(19) $\bar{y},\bar{x},z+1/2$ [v,u, \bar{w}]	(20) $\bar{x}+y,y,z+1/2$ [u-v, \bar{v},\bar{w}]	(21) x,x-y,z+1/2 [$\bar{u},\bar{u}+v,\bar{w}$]
	(22) y,x,z+1/2 [\bar{v},\bar{u},\bar{w}]	(23) x-y, $\bar{y},z+1/2$ [$\bar{u}+v,v,\bar{w}$]	(24) $\bar{x},\bar{x}+y,z+1/2$ [u,u-v, \bar{w}]
12 f m..	x,y,0 [u,v,0]	$\bar{y},x-y,0$ [$\bar{v},u-v,0$]	$\bar{x}+y,\bar{x},0$ [$\bar{u}+v,\bar{u},0$]
	$\bar{x},\bar{y},0$ [$\bar{u},\bar{v},0$]	y, $\bar{x}+y,0$ [v, $\bar{u}+v,0$]	x-y,x,0 [u-v,u,0]
	y,x,1/2 [$\bar{v},\bar{u},0$]	x-y, $\bar{y},1/2$ [$\bar{u}+v,v,0$]	$\bar{x},\bar{x}+y,1/2$ [u,u-v,0]
	$\bar{y},\bar{x},1/2$ [v,u,0]	$\bar{x}+y,y,1/2$ [u-v, $\bar{v},0$]	x,x-y,1/2 [$\bar{u},\bar{u}+v,0$]
12 e ..2	x,2x,1/4 [u,0,w]	2 $\bar{x},\bar{x},1/4$ [0,u,w]	x, $\bar{x},1/4$ [\bar{u},\bar{u},w]
	$\bar{x},2\bar{x},1/4$ [$\bar{u},0,w$]	2x,x,1/4 [0, \bar{u},w]	$\bar{x},x,1/4$ [u,u,w]
	2x,x,3/4 [0, \bar{u},\bar{w}]	$\bar{x},2\bar{x},3/4$ [$\bar{u},0,\bar{w}$]	$\bar{x},x,3/4$ [u,u, \bar{w}]
	2 $\bar{x},\bar{x},3/4$ [0,u, \bar{w}]	x,2x,3/4 [u,0, \bar{w}]	x, $\bar{x},3/4$ [\bar{u},\bar{u},\bar{w}]

Continued

No. 74.5.383

 $p6/m'cc$

12 d .2'	$x,0,1/4 [u,2u,w]$	$0,x,1/4 [2\bar{u},\bar{u},w]$	$\bar{x},\bar{x},1/4 [u,\bar{u},w]$
	$\bar{x},0,1/4 [\bar{u},2\bar{u},w]$	$0,\bar{x},1/4 [2u,u,w]$	$x,x,1/4 [\bar{u},u,w]$
	$\bar{x},0,3/4 [\bar{u},2\bar{u},\bar{w}]$	$0,\bar{x},3/4 [2u,u,\bar{w}]$	$x,x,3/4 [\bar{u},u,\bar{w}]$
	$x,0,3/4 [u,2u,\bar{w}]$	$0,x,3/4 [2\bar{u},\bar{u},\bar{w}]$	$\bar{x},\bar{x},3/4 [\bar{u},u,\bar{w}]$
4 c 6..	$0,0,z [0,0,w]$	$0,0,\bar{z}+1/2 [0,0,w]$	
	$0,0,\bar{z} [0,0,\bar{w}]$	$0,0,z+1/2 [0,0,\bar{w}]$	
2 b $6/m'..$	$0,0,0 [0,0,0]$	$0,0,1/2 [0,0,0]$	
2 a $6'2'2'$	$0,0,1/4 [0,0,w]$	$0,0,3/4 [0,0,\bar{w}]$	

Symmetry of special projections

Along [001] $6mm1'$	Along [100] $p_{2a^*}2m'm'$	Along [210] $p_{2a^*}2m'm'$
Origin at 0,0,z	$a^* = c/2$ Origin at x,0,0	$a^* = c/2$ Origin at x,x/2,0

$p6'/m'c'c$

$6'/m'm'm$

Hexagonal

No. 74.6.384

$p6'/m'2'/c'2/c$

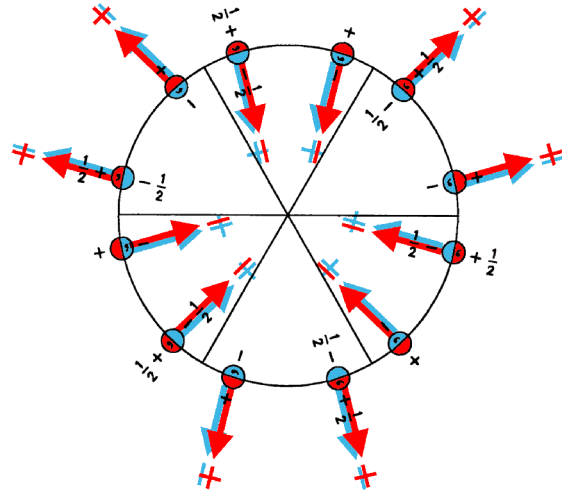
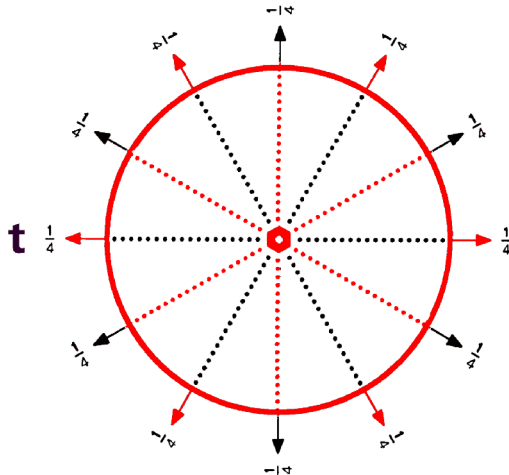

Origin at center ($6'/m'$) at $6'/m'c'c$

Asymmetric unit $0 \leq x$; $0 \leq y$; $0 \leq z \leq 1/4$; $y \leq x$

Symmetry operations

- | | | |
|--|--|---|
| (1) 1
(1 0,0,0) | (2) 3^+ 0,0,z
(3_z 0,0,0) | (3) 3^- 0,0,z
(3_z^{-1} 0,0,0) |
| (4) $2'$ 0,0,z
(2_z 0,0,0)' | (5) 6^- 0,0,z
(6_z^{-1} 0,0,0)' | (6) 6^+ 0,0,z
(6_z 0,0,0)' |
| (7) $2'$ x,x,1/4
(2_{xy} 0,0,1/2)' | (8) $2'$ x,0,1/4
(2_x 0,0,1/2)' | (9) $2'$ 0,y,1/4
(2_y 0,0,1/2)' |
| (10) 2 x, \bar{x} ,1/4
(2_3 0,0,1/2) | (11) 2 x,2x,1/4
(2_2 0,0,1/2) | (12) 2 2x,x,1/4
(2_1 0,0,1/2) |
| (13) $\bar{1}$ 0,0,0
($\bar{1}$ 0,0,0) | (14) $\bar{3}^+$ 0,0,z; 0,0,0
($\bar{3}_z$ 0,0,0) | (15) $\bar{3}^-$ 0,0,z; 0,0,0
($\bar{3}_z^{-1}$ 0,0,0) |
| (16) m' x,y,0
(m_z 0,0,0)' | (17) $\bar{6}^-$ 0,0,z; 0,0,0
($\bar{6}_z^{-1}$ 0,0,0)' | (18) $\bar{6}^+$ 0,0,z; 0,0,0
($\bar{6}_z$ 0,0,0)' |
| (19) c' (0,0,1/2) x, \bar{x} ,z
(m_{xy} 0,0,1/2)' | (20) c' (0,0,1/2) x,2x,z
(m_x 0,0,1/2)' | (21) c' (0,0,1/2) 2x,x,z
(m_y 0,0,1/2)' |
| (22) c (0,0,1/2) x,x,z
(m_3 0,0,1/2) | (23) c (0,0,1/2) x,0,z
(m_2 0,0,1/2) | (24) c (0,0,1/2) 0,y,z
(m_1 0,0,1/2) |

Generators selected (1); t(0,0,1); (2); (4); (7); (13)

Positions

	Coordinates		
Multiplicity, Wyckoff letter, Site symmetry			
24 g 1	(1) x,y,z [u,v,w]	(2) $\bar{y},x-y,z$ [$\bar{v},u-v,w$]	(3) $\bar{x}+y,\bar{x},z$ [$\bar{u}+v,\bar{u},w$]
	(4) \bar{x},\bar{y},z [u,v, \bar{w}]	(5) $y,\bar{x}+y,z$ [$\bar{v},u-v,\bar{w}$]	(6) x-y,x,z [$\bar{u}+v,\bar{u},\bar{w}$]
	(7) y,x, $\bar{z}+1/2$ [\bar{v},\bar{u},w]	(8) x-y, $\bar{y},\bar{z}+1/2$ [$\bar{u}+v,v,w$]	(9) $\bar{x},\bar{x}+y,\bar{z}+1/2$ [u,u-v,w]
	(10) $\bar{y},\bar{x},\bar{z}+1/2$ [\bar{v},\bar{u},\bar{w}]	(11) $\bar{x}+y,y,\bar{z}+1/2$ [$\bar{u}+v,v,\bar{w}$]	(12) x,x-y, $\bar{z}+1/2$ [u,u-v, \bar{w}]
	(13) \bar{x},\bar{y},\bar{z} [u,v,w]	(14) $y,\bar{x}+y,\bar{z}$ [$\bar{v},u-v,w$]	(15) x-y,x, \bar{z} [$\bar{u}+v,\bar{u},w$]
	(16) x,y, \bar{z} [u,v, \bar{w}]	(17) $\bar{y},x-y,\bar{z}$ [$\bar{v},u-v,\bar{w}$]	(18) $\bar{x}+y,\bar{x},\bar{z}$ [$\bar{u}+v,\bar{u},\bar{w}$]
	(19) $\bar{y},\bar{x},z+1/2$ [\bar{v},\bar{u},w]	(20) $\bar{x}+y,y,z+1/2$ [$\bar{u}+v,v,w$]	(21) x,x-y,z+1/2 [u,u-v,w]
	(22) y,x,z+1/2 [\bar{v},\bar{u},\bar{w}]	(23) x-y, $\bar{y},z+1/2$ [$\bar{u}+v,v,\bar{w}$]	(24) $\bar{x},\bar{x}+y,z+1/2$ [u,u-v, \bar{w}]
12 f m'..	x,y,0 [u,v,0]	$\bar{y},x-y,0$ [$\bar{v},u-v,0$]	$\bar{x}+y,\bar{x},0$ [$\bar{u}+v,\bar{u},0$]
	$\bar{x},\bar{y},0$ [u,v,0]	$y,\bar{x}+y,0$ [$\bar{v},u-v,0$]	x-y,x,0 [$\bar{u}+v,\bar{u},0$]
	y,x,1/2 [$\bar{v},\bar{u},0$]	x-y, $\bar{y},1/2$ [$\bar{u}+v,v,0$]	$\bar{x},\bar{x}+y,1/2$ [u,u-v,0]
	$\bar{y},\bar{x},1/2$ [$\bar{v},\bar{u},0$]	$\bar{x}+y,y,1/2$ [$\bar{u}+v,v,0$]	x,x-y,1/2 [u,u-v,0]
12 e ..2	x,2x,1/4 [u,2u,0]	2 $\bar{x},\bar{x},1/4$ [2 $\bar{u},\bar{u},0$]	x, $\bar{x},1/4$ [u, $\bar{u},0$]
	$\bar{x},2\bar{x},1/4$ [u,2u,0]	2x,x,1/4 [2 $\bar{u},\bar{u},0$]	$\bar{x},x,1/4$ [u, $\bar{u},0$]
	2x,x,3/4 [2 $\bar{u},\bar{u},0$]	$\bar{x},2\bar{x},3/4$ [u,2u,0]	$\bar{x},x,3/4$ [u, $\bar{u},0$]
	2 $\bar{x},\bar{x},3/4$ [2 $\bar{u},\bar{u},0$]	x,2x,3/4 [u,2u,0]	x, $\bar{x},3/4$ [u, $\bar{u},0$]

Continued

No. 74.6.384

 $p6'/m'c'c$

12 d	$.2'$	$x,0,1/4 [u,2u,w]$	$0,x,1/4 [2\bar{u},\bar{u},w]$	$\bar{x},\bar{x},1/4 [u,\bar{u},w]$
		$\bar{x},0,1/4 [u,2u,\bar{w}]$	$0,\bar{x},1/4 [2\bar{u},\bar{u},\bar{w}]$	$x,x,1/4 [u,\bar{u},\bar{w}]$
		$\bar{x},0,3/4 [u,2u,w]$	$0,\bar{x},3/4 [2\bar{u},\bar{u},w]$	$x,x,3/4 [u,\bar{u},w]$
		$x,0,3/4 [u,2u,\bar{w}]$	$0,x,3/4 [2\bar{u},\bar{u},\bar{w}]$	$\bar{x},\bar{x},3/4 [u,\bar{u},\bar{w}]$
4 c	$6'..$	$0,0,z [0,0,0]$	$0,0,\bar{z}+1/2 [0,0,0]$	
		$0,0,\bar{z} [0,0,0]$	$0,0,z+1/2 [0,0,0]$	
2 b	$6'/m'..$	$0,0,0 [0,0,0]$	$0,0,1/2 [0,0,0]$	
2 a	$6'2'2$	$0,0,1/4 [0,0,0]$	$0,0,3/4 [0,0,0]$	

Symmetry of special projections

Along [001] $6mm1'$	Along [100] $p2'm'm$	Along [210] $p_{2a^*}2'm'm$
Origin at 0,0,z	$a^* = c/2$ Origin at x,0,0	$a^* = c/2$ Origin at x,x/2,0

$p6'/mcc'$

$6'/mmm'$

Hexagonal

No. 74.7.385

$p6'/m2'/c2'/c'$

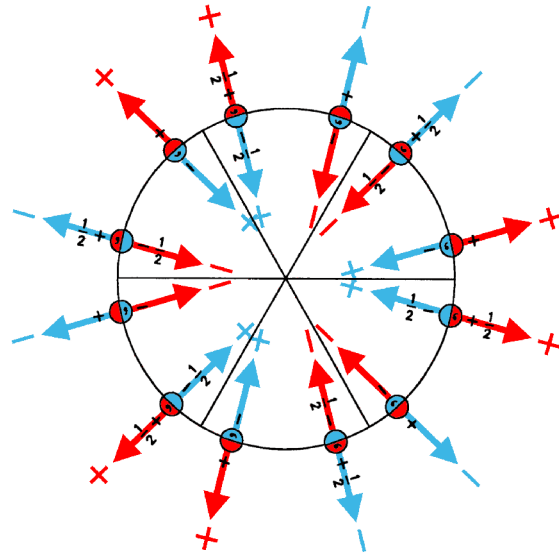
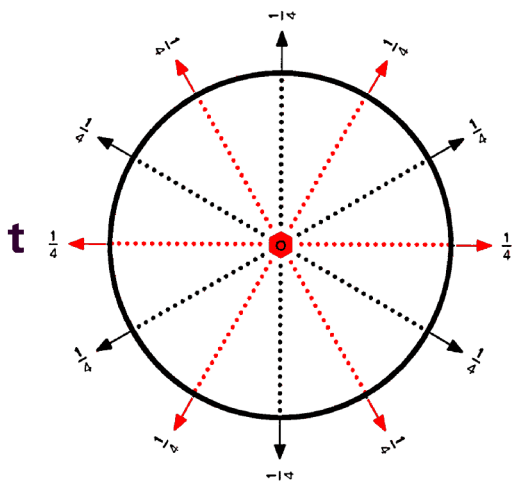

Origin at center ($6'/m$) at $6'/mcc'$

Asymmetric unit $0 \leq x$; $0 \leq y$; $0 \leq z \leq 1/4$; $y \leq x$

Symmetry operations

- | | | |
|--|---|--|
| (1) 1
(1 0,0,0) | (2) 3^+ 0,0,z
(3_z 0,0,0) | (3) 3^- 0,0,z
(3_z^{-1} 0,0,0) |
| (4) $2'$ 0,0,z
(2_z 0,0,0)' | (5) 6^- 0,0,z
(6_z^{-1} 0,0,0)' | (6) 6^+ 0,0,z
(6_z 0,0,0)' |
| (7) $2'$ x,x,1/4
(2_{xy} 0,0,1/2)' | (8) $2'$ x,0,1/4
(2_x 0,0,1/2)' | (9) $2'$ 0,y,1/4
(2_y 0,0,1/2)' |
| (10) 2 x, \bar{x} ,1/4
(2_3 0,0,1/2) | (11) 2 x,2x,1/4
(2_2 0,0,1/2) | (12) 2 2x,x,1/4
(2_1 0,0,1/2) |
| (13) $\bar{1}$ 0,0,0
($\bar{1}$ 0,0,0)' | (14) $\bar{3}^+$ 0,0,z; 0,0,0
($\bar{3}_z$ 0,0,0)' | (15) $\bar{3}^-$ 0,0,z; 0,0,0
($\bar{3}_z^{-1}$ 0,0,0)' |
| (16) m x,y,0
(m_z 0,0,0) | (17) $\bar{6}^-$ 0,0,z; 0,0,0
($\bar{6}_z^{-1}$ 0,0,0) | (18) $\bar{6}^+$ 0,0,z; 0,0,0
($\bar{6}_z$ 0,0,0) |
| (19) c (0,0,1/2) x, \bar{x} ,z
(m_{xy} 0,0,1/2) | (20) c (0,0,1/2) x,2x,z
(m_x 0,0,1/2) | (21) c (0,0,1/2) 2x,x,z
(m_y 0,0,1/2) |
| (22) c' (0,0,1/2) x,x,z
(m_3 0,0,1/2)' | (23) c' (0,0,1/2) x,0,z
(m_2 0,0,1/2)' | (24) c' (0,0,1/2) 0,y,z
(m_1 0,0,1/2)' |

Generators selected (1); t(0,0,1); (2); (4); (7); (13)

Positions

	Coordinates		
Multiplicity, Wyckoff letter, Site symmetry			
24 g 1	(1) x,y,z [u,v,w]	(2) $\bar{y},x-y,z$ [$\bar{v},u-v,w$]	(3) $\bar{x}+y,\bar{x},z$ [$\bar{u}+v,\bar{u},w$]
	(4) \bar{x},\bar{y},z [u,v, \bar{w}]	(5) $y,\bar{x}+y,z$ [$\bar{v},u-v,\bar{w}$]	(6) x-y,x,z [$\bar{u}+v,\bar{u},\bar{w}$]
	(7) y,x, $\bar{z}+1/2$ [\bar{v},\bar{u},w]	(8) x-y, $\bar{y},\bar{z}+1/2$ [$\bar{u}+v,v,w$]	(9) $\bar{x},\bar{x}+y,\bar{z}+1/2$ [u,u-v,w]
	(10) $\bar{y},\bar{x},\bar{z}+1/2$ [\bar{v},\bar{u},\bar{w}]	(11) $\bar{x}+y,y,\bar{z}+1/2$ [$\bar{u}+v,v,\bar{w}$]	(12) x,x-y, $\bar{z}+1/2$ [u,u-v, \bar{w}]
	(13) \bar{x},\bar{y},\bar{z} [\bar{u},\bar{v},\bar{w}]	(14) $y,\bar{x}+y,\bar{z}$ [v, $\bar{u}+v,\bar{w}$]	(15) x-y,x, \bar{z} [u-v,u, \bar{w}]
	(16) x,y, \bar{z} [\bar{u},\bar{v},w]	(17) $\bar{y},x-y,\bar{z}$ [v, $\bar{u}+v,w$]	(18) $\bar{x}+y,\bar{x},\bar{z}$ [u-v,u,w]
	(19) $\bar{y},\bar{x},z+1/2$ [v,u, \bar{w}]	(20) $\bar{x}+y,y,z+1/2$ [u-v, \bar{v},\bar{w}]	(21) x,x-y,z+1/2 [$\bar{u},\bar{u}+v,\bar{w}$]
	(22) y,x,z+1/2 [v,u,w]	(23) x-y, $\bar{y},z+1/2$ [u-v, \bar{v},w]	(24) $\bar{x},\bar{x}+y,z+1/2$ [$\bar{u},\bar{u}+v,w$]
12 f m..	x,y,0 [0,0,w]	$\bar{y},x-y,0$ [0,0,w]	$\bar{x}+y,\bar{x},0$ [0,0,w]
	$\bar{x},\bar{y},0$ [0,0, \bar{w}]	y, $\bar{x}+y,0$ [0,0, \bar{w}]	x-y,x,0 [0,0, \bar{w}]
	y,x,1/2 [0,0,w]	x-y, $\bar{y},1/2$ [0,0,w]	$\bar{x},\bar{x}+y,1/2$ [0,0,w]
	$\bar{y},\bar{x},1/2$ [0,0, \bar{w}]	$\bar{x}+y,y,1/2$ [0,0, \bar{w}]	x,x-y,1/2 [0,0, \bar{w}]
12 e ..2	x,2x,1/4 [u,2u,0]	2 $\bar{x},\bar{x},1/4$ [2 $\bar{u},\bar{u},0$]	x, $\bar{x},1/4$ [u, $\bar{u},0$]
	$\bar{x},2\bar{x},1/4$ [u,2u,0]	2x,x,1/4 [2 $\bar{u},\bar{u},0$]	$\bar{x},x,1/4$ [u, $\bar{u},0$]
	2x,x,3/4 [2u,u,0]	$\bar{x},2\bar{x},3/4$ [$\bar{u},2\bar{u},0$]	$\bar{x},x,3/4$ [$\bar{u},u,0$]
	2 $\bar{x},\bar{x},3/4$ [2u,u,0]	x,2x,3/4 [$\bar{u},2\bar{u},0$]	x, $\bar{x},3/4$ [$\bar{u},u,0$]

Continued

No. 74.7.385

 $p6'/mcc'$

12 d $.2'$	$x,0,1/4 [u,2u,w]$	$0,x,1/4 [2\bar{u},\bar{u},w]$	$\bar{x},\bar{x},1/4 [u,\bar{u},w]$
	$\bar{x},0,1/4 [u,2u,\bar{w}]$	$0,\bar{x},1/4 [2\bar{u},\bar{u},\bar{w}]$	$x,x,1/4 [u,\bar{u},\bar{w}]$
	$\bar{x},0,3/4 [\bar{u},2\bar{u},\bar{w}]$	$0,\bar{x},3/4 [2u,u,\bar{w}]$	$x,x,3/4 [\bar{u},u,\bar{w}]$
	$x,0,3/4 [\bar{u},2\bar{u},w]$	$0,x,3/4 [2u,u,w]$	$\bar{x},\bar{x},3/4 [\bar{u},u,w]$
4 c $6'..$	$0,0,z [0,0,0]$	$0,0,\bar{z}+1/2 [0,0,0]$	
	$0,0,\bar{z} [0,0,0]$	$0,0,z+1/2 [0,0,0]$	
2 b $6'/m..$	$0,0,0 [0,0,0]$	$0,0,1/2 [0,0,0]$	
2 a $6'2'2$	$0,0,1/4 [0,0,0]$	$0,0,3/4 [0,0,0]$	

Symmetry of special projections

Along [001] $6'mm'$	Along [100] $p_{2a^*}2mm$	Along [210] $p2mm$
Origin at 0,0,z	$a^* = c/2$ Origin at x,0,0	$a^* = c/2$ Origin at x,x/2,0

$p6_3/mmc$

$6/mmm$

Hexagonal

No. 75.1.386

$p6_3/m2/m2/c$

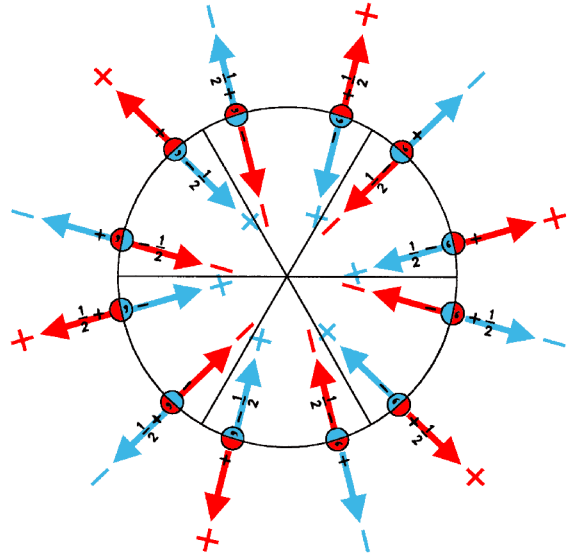
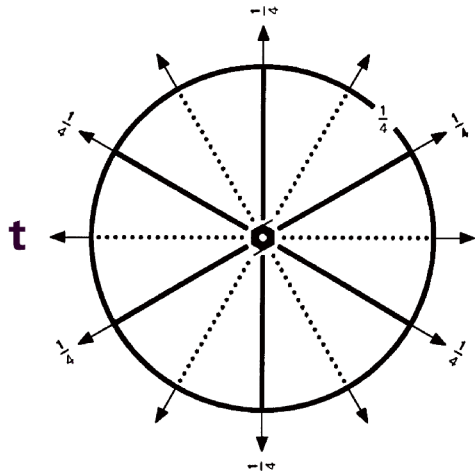

Origin at center ($\bar{3}m1$) at $\bar{3}2/mc$

Asymmetric unit $y \leq x/2$; $y \geq -x$; $0 \leq z \leq 1/4$

Symmetry operations

- | | | |
|---|---|---|
| (1) 1
(1 0,0,0) | (2) 3^+ 0,0,z
(3_z 0,0,0) | (3) 3^- 0,0,z
(3_z^{-1} 0,0,0) |
| (4) 2 (0,0,1/2) 0,0,z
(2_z 0,0,1/2) | (5) 6^- (0,0,1/2) 0,0,z
(6_z^{-1} 0,0,1/2) | (6) 6^+ (0,0,1/2) 0,0,z
(6_z 0,0,1/2) |
| (7) 2 x,x,0
(2_{xy} 0,0,0) | (8) 2 x,0,0
(2_x 0,0,0) | (9) 2 0,y,0
(2_y 0,0,0) |
| (10) 2 x, \bar{x} ,1/4
(2_3 0,0,1/2) | (11) 2 x,2x,1/4
(2_2 0,0,1/2) | (12) 2 2x,x,1/4
(2_1 0,0,1/2) |
| (13) $\bar{1}$ 0,0,0
($\bar{1}$ 0,0,0) | (14) $\bar{3}^+$ 0,0,z; 0,0,0
($\bar{3}_z$ 0,0,0) | (15) $\bar{3}^-$ 0,0,z; 0,0,0
($\bar{3}_z^{-1}$ 0,0,0) |
| (16) m x,y,1/4
(m_z 0,0,1/2) | (17) $\bar{6}^-$ 0,0,z; 0,0,1/4
($\bar{6}_z^{-1}$ 0,0,1/2) | (18) $\bar{6}^+$ 0,0,z; 0,0,1/4
($\bar{6}_z$ 0,0,1/2) |
| (19) m x, \bar{x} ,z
(m_{xy} 0,0,0) | (20) m x,2x,z
(m_x 0,0,0) | (21) m 2x,x,z
(m_y 0,0,0) |
| (22) c (0,0,1/2) x,x,z
(m_3 0,0,1/2) | (23) c (0,0,1/2) x,0,z
(m_2 0,0,1/2) | (24) c (0,0,1/2) 0,y,z
(m_1 0,0,1/2) |

Generators selected (1); $t(0,0,1)$; (2); (4); (7); (13)

Positions

	Coordinates		
Multiplicity, Wyckoff letter, Site symmetry			
24 h 1	(1) $x,y,z [u,v,w]$	(2) $\bar{y},x-y,z [\bar{v},u-v,w]$	(3) $\bar{x}+y,\bar{x},z [\bar{u}+v,\bar{u},w]$
	(4) $\bar{x},\bar{y},z+1/2 [\bar{u},\bar{v},w]$	(5) $y,\bar{x}+y,z+1/2 [v,\bar{u}+v,w]$	(6) $x-y,x,z+1/2 [u-v,u,w]$
	(7) $y,x,\bar{z} [v,u,\bar{w}]$	(8) $x-y,\bar{y},\bar{z} [u-v,\bar{v},\bar{w}]$	(9) $\bar{x},\bar{x}+y,\bar{z} [\bar{u},\bar{u}+v,\bar{w}]$
	(10) $\bar{y},\bar{x},\bar{z}+1/2 [\bar{v},\bar{u},\bar{w}]$	(11) $\bar{x}+y,y,\bar{z}+1/2 [\bar{u}+v,v,\bar{w}]$	(12) $x,x-y,\bar{z}+1/2 [u,u-v,\bar{w}]$
	(13) $\bar{x},\bar{y},\bar{z} [u,v,w]$	(14) $y,\bar{x}+y,\bar{z} [\bar{v},u-v,w]$	(15) $x-y,x,\bar{z} [\bar{u}+v,\bar{u},w]$
	(16) $x,y,\bar{z}+1/2 [\bar{u},\bar{v},w]$	(17) $\bar{y},x-y,\bar{z}+1/2 [v,\bar{u}+v,w]$	(18) $\bar{x}+y,\bar{x},\bar{z}+1/2 [u-v,u,w]$
	(19) $\bar{y},\bar{x},z [v,u,\bar{w}]$	(20) $\bar{x}+y,y,z [u-v,\bar{v},\bar{w}]$	(21) $x,x-y,z [\bar{u},\bar{u}+v,\bar{w}]$
	(22) $y,x,z+1/2 [\bar{v},\bar{u},\bar{w}]$	(23) $x-y,\bar{y},z+1/2 [\bar{u}+v,v,\bar{w}]$	(24) $\bar{x},\bar{x}+y,z+1/2 [u,u-v,\bar{w}]$
12 g .m.	$x,2x,z [u,0,0]$	$2\bar{x},\bar{x},z [0,u,0]$	$x,\bar{x},z [\bar{u},\bar{u},0]$
	$\bar{x},2\bar{x},z+1/2 [\bar{u},0,0]$	$2x,x,z+1/2 [0,\bar{u},0]$	$\bar{x},x,z+1/2 [u,u,0]$
	$2x,x,\bar{z} [0,u,0]$	$\bar{x},2\bar{x},\bar{z} [u,0,0]$	$\bar{x},x,\bar{z} [\bar{u},\bar{u},0]$
	$2\bar{x},\bar{x},\bar{z}+1/2 [0,\bar{u},0]$	$x,2x,\bar{z}+1/2 [\bar{u},0,0]$	$x,\bar{x},\bar{z}+1/2 [\bar{u},\bar{u},0]$
12 f m..	$x,y,1/4 [0,0,w]$	$\bar{y},x-y,1/4 [0,0,w]$	$\bar{x}+y,\bar{x},1/4 [0,0,w]$
	$\bar{x},\bar{y},3/4 [0,0,w]$	$y,\bar{x}+y,3/4 [0,0,w]$	$x-y,x,3/4 [0,0,w]$
	$y,x,3/4 [0,0,\bar{w}]$	$x-y,\bar{y},3/4 [0,0,\bar{w}]$	$\bar{x},\bar{x}+y,3/4 [0,0,\bar{w}]$
	$\bar{y},\bar{x},1/4 [0,0,\bar{w}]$	$\bar{x}+y,y,1/4 [0,0,\bar{w}]$	$x,x-y,1/4 [0,0,\bar{w}]$

Continued

No. 75.1.386

 $p6_3/mmc$

12 e .2.	$x,0,0 [u,0,0]$	$0,x,0 [0,u,0]$	$\bar{x},\bar{x},0 [\bar{u},\bar{u},0]$
	$\bar{x},0,1/2 [\bar{u},0,0]$	$0,\bar{x},1/2 [0,\bar{u},0]$	$x,x,1/2 [u,u,0]$
	$\bar{x},0,0 [u,0,0]$	$0,\bar{x},0 [0,u,0]$	$x,x,0 [\bar{u},\bar{u},0]$
	$x,0,1/2 [\bar{u},0,0]$	$0,x,1/2 [0,\bar{u},0]$	$\bar{x},\bar{x},1/2 [u,u,0]$
6 d mm_2	$x,2x,1/4 [0,0,0]$	$2\bar{x},\bar{x},1/4 [0,0,0]$	$x,\bar{x},1/4 [0,0,0]$
	$\bar{x},2\bar{x},3/4 [0,0,0]$	$2x,x,3/4 [0,0,0]$	$\bar{x},x,3/4 [0,0,0]$
4 c $3m$.	$0,0,z [0,0,0]$	$0,0,z+1/2 [0,0,0]$	
	$0,0,\bar{z} [0,0,0]$	$0,0,\bar{z}+1/2 [0,0,0]$	
2 b $\bar{6}m_2$	$0,0,1/4 [0,0,0]$	$0,0,3/4 [0,0,0]$	
2 a $\bar{3}m$.	$0,0,0 [0,0,0]$	$0,0,1/2 [0,0,0]$	

Symmetry of special projections

Along [001] $6mm$ Origin at $0,0,z$ Along [100] $p2mg1'$ $a^* = c$ Origin at $x,0,0$ Along [210] $p_{2a^*}2'm'm$ $a^* = c/2$ Origin at $x,x/2,0$

$p6_3/mmc1'$

$6/mmm1'$

Hexagonal

No. 75.2.387

$p6_3/m2/m2/c1'$

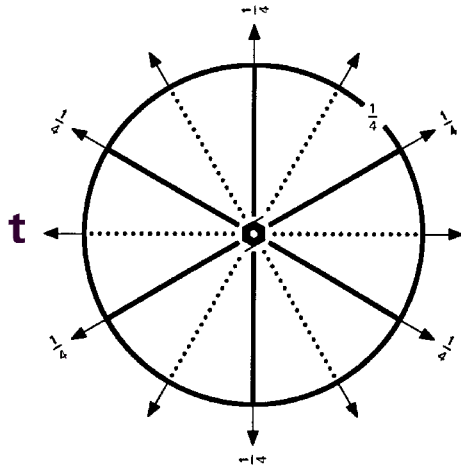

1'

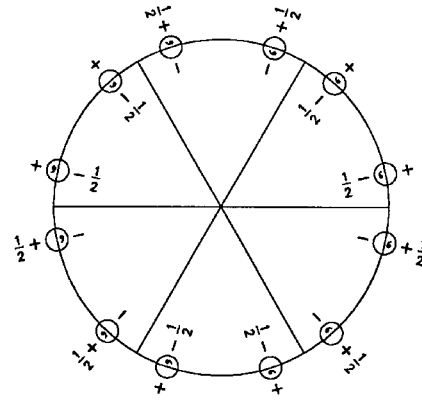

Origin at center ($\bar{3}m11'$) at $\bar{3}2/mc1'$

Asymmetric unit $y \leq x/2$; $y \geq -x$; $0 \leq z \leq 1/4$

Symmetry operations

For 1 + set

- | | | |
|---|---|---|
| (1) 1
(1 0,0,0) | (2) 3^+ 0,0,z
(3_z 0,0,0) | (3) 3^- 0,0,z
(3_z^{-1} 0,0,0) |
| (4) 2 (0,0,1/2) 0,0,z
(2_z 0,0,1/2) | (5) 6^- (0,0,1/2) 0,0,z
(6_z^{-1} 0,0,1/2) | (6) 6^+ (0,0,1/2) 0,0,z
(6_z 0,0,1/2) |
| (7) 2 x,x,0
(2_{xy} 0,0,0) | (8) 2 x,0,0
(2_x 0,0,0) | (9) 2 0,y,0
(2_y 0,0,0) |
| (10) 2 x, \bar{x} ,1/4
(2_3 0,0,1/2) | (11) 2 x,2x,1/4
(2_2 0,0,1/2) | (12) 2 2x,x,1/4
(2_1 0,0,1/2) |
| (13) $\bar{1}$ 0,0,0
($\bar{1}$ 0,0,0) | (14) $\bar{3}^+$ 0,0,z; 0,0,0
($\bar{3}_z$ 0,0,0) | (15) $\bar{3}^-$ 0,0,z; 0,0,0
($\bar{3}_z^{-1}$ 0,0,0) |
| (16) m x,y,1/4
(m_z 0,0,1/2) | (17) $\bar{6}^-$ 0,0,z; 0,0,1/4
($\bar{6}_z^{-1}$ 0,0,1/2) | (18) $\bar{6}^+$ 0,0,z; 0,0,1/4
($\bar{6}_z$ 0,0,1/2) |
| (19) m x, \bar{x} ,z
(m_{xy} 0,0,0) | (20) m x,2x,z
(m_x 0,0,0) | (21) m 2x,x,z
(m_y 0,0,0) |
| (22) c (0,0,1/2) x,x,z
(m_3 0,0,1/2) | (23) c (0,0,1/2) x,0,z
(m_2 0,0,1/2) | (24) c (0,0,1/2) 0,y,z
(m_1 0,0,1/2) |

For 1' + set

$$(1) 1' \\ (1|0,0,0)'$$

$$(4) 2' (0,0,1/2) \quad 0,0,z \\ (2_z|0,0,1/2)'$$

$$(7) 2' \quad x,x,0 \\ (2_{xy}|0,0,0)'$$

$$(10) 2' \quad x,\bar{x},1/4 \\ (2_3|0,0,1/2)'$$

$$(13) \bar{1}' \quad 0,0,0 \\ (\bar{1}|0,0,0)'$$

$$(16) m' \quad x,y,1/4 \\ (m_2|0,0,1/2)'$$

$$(19) m' \quad x,\bar{x},z \\ (m_{xy}|0,0,0)'$$

$$(22) c' (0,0,1/2) \quad x,x,z \\ (m_3|0,0,1/2)'$$

$$(2) 3^{+'} \quad 0,0,z \\ (3_z|0,0,0)'$$

$$(5) 6^{-'} (0,0,1/2) \quad 0,0,z \\ (6_z^{-1}|0,0,1/2)'$$

$$(8) 2' \quad x,0,0 \\ (2_x|0,0,0)'$$

$$(11) 2' \quad x,2x,1/4 \\ (2_2|0,0,1/2)'$$

$$(14) \bar{3}^{+'} \quad 0,0,z; 0,0,0 \\ (\bar{3}_z|0,0,0)'$$

$$(17) \bar{6}^{-'} \quad 0,0,z; 0,0,1/4 \\ (\bar{6}_z^{-1}|0,0,1/2)'$$

$$(20) m' \quad x,2x,z \\ (m_x|0,0,0)'$$

$$(23) c' (0,0,1/2) \quad x,0,z \\ (m_2|0,0,1/2)'$$

$$(3) 3^{-'} \quad 0,0,z \\ (3_z^{-1}|0,0,0)'$$

$$(6) 6^{+'} (0,0,1/2) \quad 0,0,z \\ (6_z|0,0,1/2)'$$

$$(9) 2' \quad 0,y,0 \\ (2_y|0,0,0)'$$

$$(12) 2' \quad 2x,x,1/4 \\ (2_1|0,0,1/2)'$$

$$(15) \bar{3}^{-'} \quad 0,0,z; 0,0,0 \\ (\bar{3}_z^{-1}|0,0,0)'$$

$$(18) \bar{6}^{+'} \quad 0,0,z; 0,0,1/4 \\ (\bar{6}_z|0,0,1/2)'$$

$$(21) m' \quad 2x,x,z \\ (m_y|0,0,0)'$$

$$(24) c' (0,0,1/2) \quad 0,y,z \\ (m_1|0,0,1/2)'$$

Generators selected (1); $t(0,0,1)$; (2); (4); (7); (13); $1'$

Positions

Multiplicity, Wyckoff letter, Site symmetry	Coordinates		
		1+	1' +
24 h 11'	(1) $x,y,z [0,0,0]$	(2) $\bar{y},x-y,z [0,0,0]$	(3) $\bar{x}+y,\bar{x},z [0,0,0]$
	(4) $\bar{x},\bar{y},z+1/2 [0,0,0]$	(5) $y,\bar{x}+y,z+1/2 [0,0,0]$	(6) $x-y,x,z+1/2 [0,0,0]$
	(7) $y,x,\bar{z} [0,0,0]$	(8) $x-y,\bar{y},\bar{z} [0,0,0]$	(9) $\bar{x},\bar{x}+y,\bar{z} [0,0,0]$
	(10) $\bar{y},\bar{x},\bar{z}+1/2 [0,0,0]$	(11) $\bar{x}+y,y,\bar{z}+1/2 [0,0,0]$	(12) $x,x-y,\bar{z}+1/2 [0,0,0]$
	(13) $\bar{x},\bar{y},\bar{z} [0,0,0]$	(14) $y,\bar{x}+y,\bar{z} [0,0,0]$	(15) $x-y,x,\bar{z} [0,0,0]$
	(16) $x,y,\bar{z}+1/2 [0,0,0]$	(17) $\bar{y},x-y,\bar{z}+1/2 [0,0,0]$	(18) $\bar{x}+y,\bar{x},\bar{z}+1/2 [0,0,0]$
	(19) $\bar{y},\bar{x},z [0,0,0]$	(20) $\bar{x}+y,y,z [0,0,0]$	(21) $x,x-y,z [0,0,0]$
	(22) $y,x,z+1/2 [0,0,0]$	(23) $x-y,\bar{y},z+1/2 [0,0,0]$	(24) $\bar{x},\bar{x}+y,z+1/2 [0,0,0]$
12 g .m.1'	$x,2x,z [0,0,0]$	$2\bar{x},\bar{x},z [0,0,0]$	$x,\bar{x},z [0,0,0]$
	$\bar{x},2\bar{x},z+1/2 [0,0,0]$	$2x,x,z+1/2 [0,0,0]$	$\bar{x},x,z+1/2 [0,0,0]$
	$2x,x,\bar{z} [0,0,0]$	$\bar{x},2\bar{x},\bar{z} [0,0,0]$	$\bar{x},x,\bar{z} [0,0,0]$
	$2\bar{x},\bar{x},\bar{z}+1/2 [0,0,0]$	$x,2x,\bar{z}+1/2 [0,0,0]$	$x,\bar{x},\bar{z}+1/2 [0,0,0]$
12 f m..1'	$x,y,1/4 [0,0,0]$	$\bar{y},x-y,1/4 [0,0,0]$	$\bar{x}+y,\bar{x},1/4 [0,0,0]$
	$\bar{x},\bar{y},3/4 [0,0,0]$	$y,\bar{x}+y,3/4 [0,0,0]$	$x-y,x,3/4 [0,0,0]$
	$y,x,3/4 [0,0,0]$	$x-y,\bar{y},3/4 [0,0,0]$	$\bar{x},\bar{x}+y,3/4 [0,0,0]$
	$\bar{y},\bar{x},1/4 [0,0,0]$	$\bar{x}+y,y,1/4 [0,0,0]$	$x,x-y,1/4 [0,0,0]$

Continued

No. 75.2.387

 $p6_3/mmc1'$

12 e .2.1'	$x,0,0 [0,0,0]$	$0,x,0 [0,0,0]$	$\bar{x},\bar{x},0 [0,0,0]$
	$\bar{x},0,1/2 [0,0,0]$	$0,\bar{x},1/2 [0,0,0]$	$x,x,1/2 [0,0,0]$
	$\bar{x},0,0 [0,0,0]$	$0,\bar{x},0 [0,0,0]$	$x,x,0 [0,0,0]$
	$x,0,1/2 [0,0,0]$	$0,x,1/2 [0,0,0]$	$\bar{x},\bar{x},1/2 [0,0,0]$
6 d $\bar{m}m21'$	$x,2x,1/4 [0,0,0]$	$2\bar{x},\bar{x},1/4 [0,0,0]$	$x,\bar{x},1/4 [0,0,0]$
	$\bar{x},2\bar{x},3/4 [0,0,0]$	$2x,x,3/4 [0,0,0]$	$\bar{x},x,3/4 [0,0,0]$
4 c $3m.1'$	$0,0,z [0,0,0]$	$0,0,z+1/2 [0,0,0]$	
	$0,0,\bar{z} [0,0,0]$	$0,0,\bar{z}+1/2 [0,0,0]$	
2 b $\bar{6}m21'$	$0,0,1/4 [0,0,0]$	$0,0,3/4 [0,0,0]$	
2 a $\bar{3}m.1'$	$0,0,0 [0,0,0]$	$0,0,1/2 [0,0,0]$	

Symmetry of special projections

Along [001] $6mm1'$	Along [100] $p2mg1'$	Along [210] $p2mm1'$
Origin at $0,0,z$	$a^* = c$ Origin at $x,0,0$	$a^* = c/2$ Origin at $x,x/2,0$

$p6_3/m'm'c'$

$6/m'm'm'$

Hexagonal

No. 75.3.388

$p6_3/m'2/m'2/c'$

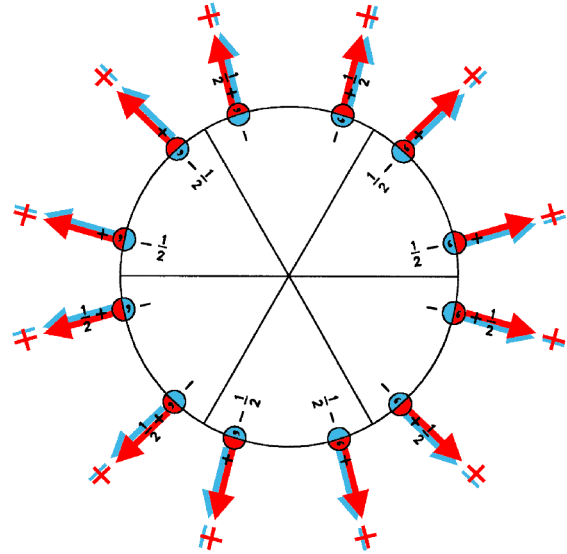
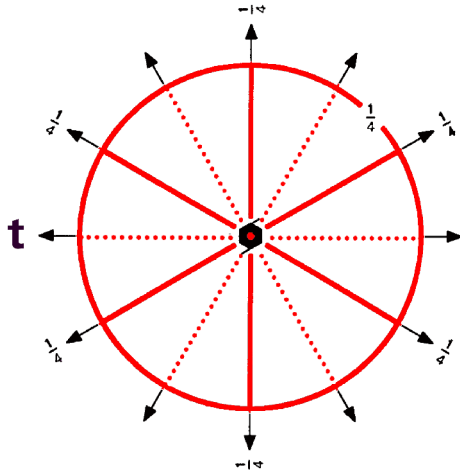

Origin at center ($\bar{3}'m'1$) at $\bar{3}'2/m'c'$

Asymmetric unit $y \leq x/2$; $y \geq -x$; $0 \leq z \leq 1/4$

Symmetry operations

- | | | |
|--|--|--|
| (1) 1
(1 0,0,0) | (2) 3^+ 0,0,z
(3_z 0,0,0) | (3) 3^- 0,0,z
(3_z^{-1} 0,0,0) |
| (4) 2 (0,0,1/2) 0,0,z
(2_z 0,0,1/2) | (5) 6^- (0,0,1/2) 0,0,z
(6_z^{-1} 0,0,1/2) | (6) 6^+ (0,0,1/2) 0,0,z
(6_z 0,0,1/2) |
| (7) 2 x,x,0
(2_{xy} 0,0,0) | (8) 2 x,0,0
(2_x 0,0,0) | (9) 2 0,y,0
(2_y 0,0,0) |
| (10) 2 x, \bar{x} ,1/4
(2_3 0,0,1/2) | (11) 2 x,2x,1/4
(2_2 0,0,1/2) | (12) 2 2x,x,1/4
(2_1 0,0,1/2) |
| (13) $\bar{1}$ 0,0,0
($\bar{1}$ 0,0,0)' | (14) $\bar{3}^+$ 0,0,z; 0,0,0
($\bar{3}_z$ 0,0,0)' | (15) $\bar{3}^-$ 0,0,z; 0,0,0
($\bar{3}_z^{-1}$ 0,0,0)' |
| (16) m' x,y,1/4
(m_z 0,0,1/2)' | (17) $\bar{6}^-$ 0,0,z; 0,0,1/4
($\bar{6}_z^{-1}$ 0,0,1/2)' | (18) $\bar{6}^+$ 0,0,z; 0,0,1/4
($\bar{6}_z$ 0,0,1/2)' |
| (19) m' x, \bar{x} ,z
(m_{xy} 0,0,0)' | (20) m' x,2x,z
(m_x 0,0,0)' | (21) m' 2x,x,z
(m_y 0,0,0)' |
| (22) c' (0,0,1/2) x,x,z
(m_3 0,0,1/2)' | (23) c' (0,0,1/2) x,0,z
(m_2 0,0,1/2)' | (24) c' (0,0,1/2) 0,y,z
(m_1 0,0,1/2)' |

Generators selected (1); $t(0,0,1)$; (2); (4); (7); (13)

Positions

	Coordinates		
Multiplicity, Wyckoff letter, Site symmetry			
24 h 1	(1) x,y,z $[u,v,w]$	(2) $\bar{y},x-y,z$ $[\bar{v},u-v,w]$	(3) $\bar{x}+y,\bar{x},z$ $[\bar{u}+v,\bar{u},w]$
	(4) $\bar{x},\bar{y},z+1/2$ $[\bar{u},\bar{v},w]$	(5) $y,\bar{x}+y,z+1/2$ $[v,\bar{u}+v,w]$	(6) $x-y,x,z+1/2$ $[u-v,u,w]$
	(7) y,x,\bar{z} $[v,u,\bar{w}]$	(8) $x-y,\bar{y},\bar{z}$ $[u-v,\bar{v},\bar{w}]$	(9) $\bar{x},\bar{x}+y,\bar{z}$ $[\bar{u},\bar{u}+v,\bar{w}]$
	(10) $\bar{y},\bar{x},\bar{z}+1/2$ $[\bar{v},\bar{u},\bar{w}]$	(11) $\bar{x}+y,y,\bar{z}+1/2$ $[\bar{u}+v,v,\bar{w}]$	(12) $x,x-y,\bar{z}+1/2$ $[u,u-v,\bar{w}]$
	(13) \bar{x},\bar{y},\bar{z} $[\bar{u},\bar{v},\bar{w}]$	(14) $y,\bar{x}+y,\bar{z}$ $[v,\bar{u}+v,\bar{w}]$	(15) $x-y,x,\bar{z}$ $[u-v,u,\bar{w}]$
	(16) $x,y,\bar{z}+1/2$ $[u,v,\bar{w}]$	(17) $\bar{y},x-y,\bar{z}+1/2$ $[\bar{v},u-v,\bar{w}]$	(18) $\bar{x}+y,\bar{x},\bar{z}+1/2$ $[\bar{u}+v,\bar{u},\bar{w}]$
	(19) \bar{y},\bar{x},z $[\bar{v},\bar{u},w]$	(20) $\bar{x}+y,y,z$ $[\bar{u}+v,v,w]$	(21) $x,x-y,z$ $[u,u-v,w]$
	(22) $y,x,z+1/2$ $[v,u,w]$	(23) $x-y,\bar{y},z+1/2$ $[u-v,\bar{v},w]$	(24) $\bar{x},\bar{x}+y,z+1/2$ $[\bar{u},\bar{u}+v,w]$
12 g .m'	$x,2x,z$ $[u,2u,w]$	$2\bar{x},\bar{x},z$ $[2\bar{u},\bar{u},w]$	x,\bar{x},z $[u,\bar{u},w]$
	$\bar{x},2\bar{x},z+1/2$ $[\bar{u},2\bar{u},w]$	$2x,x,z+1/2$ $[2u,u,w]$	$\bar{x},x,z+1/2$ $[\bar{u},u,w]$
	$2x,x,\bar{z}$ $[2u,u,\bar{w}]$	$\bar{x},2\bar{x},\bar{z}$ $[\bar{u},2\bar{u},\bar{w}]$	\bar{x},x,\bar{z} $[\bar{u},u,\bar{w}]$
	$2\bar{x},\bar{x},\bar{z}+1/2$ $[2\bar{u},\bar{u},\bar{w}]$	$x,2x,\bar{z}+1/2$ $[u,2u,\bar{w}]$	$x,\bar{x},\bar{z}+1/2$ $[u,\bar{u},\bar{w}]$
12 f m'.	$x,y,1/4$ $[u,v,0]$	$\bar{y},x-y,1/4$ $[\bar{v},u-v,0]$	$\bar{x}+y,\bar{x},1/4$ $[\bar{u}+v,\bar{u},0]$
	$\bar{x},\bar{y},3/4$ $[\bar{u},\bar{v},0]$	$y,\bar{x}+y,3/4$ $[v,\bar{u}+v,0]$	$x-y,x,3/4$ $[u-v,u,0]$
	$y,x,3/4$ $[v,u,0]$	$x-y,\bar{y},3/4$ $[u-v,\bar{v},0]$	$\bar{x},\bar{x}+y,3/4$ $[\bar{u},\bar{u}+v,0]$
	$\bar{y},\bar{x},1/4$ $[\bar{v},\bar{u},0]$	$\bar{x}+y,y,1/4$ $[\bar{u}+v,v,0]$	$x,x-y,1/4$ $[u,u-v,0]$

Continued

No. 75.3.388

 $p6_3/m'm'c'$

12 e .2.	$x,0,0 [u,0,0]$	$0,x,0 [0,u,0]$	$\bar{x},\bar{x},0 [\bar{u},\bar{u},0]$
	$\bar{x},0,1/2 [\bar{u},0,0]$	$0,\bar{x},1/2 [0,\bar{u},0]$	$x,x,1/2 [u,u,0]$
	$\bar{x},0,0 [\bar{u},0,0]$	$0,\bar{x},0 [0,\bar{u},0]$	$x,x,0 [u,u,0]$
	$x,0,1/2 [u,0,0]$	$0,x,1/2 [0,u,0]$	$\bar{x},\bar{x},1/2 [\bar{u},\bar{u},0]$
6 d $\bar{6}m'2$	$x,2x,1/4 [u,2u,0]$	$2\bar{x},\bar{x},1/4 [2\bar{u},\bar{u},0]$	$x,\bar{x},1/4 [u,\bar{u},0]$
	$\bar{x},2\bar{x},3/4 [\bar{u},2\bar{u},0]$	$2x,x,3/4 [2u,u,0]$	$\bar{x},x,3/4 [\bar{u},u,0]$
4 c $3m'$	$0,0,z [0,0,w]$	$0,0,z+1/2 [0,0,w]$	
	$0,0,\bar{z} [0,0,\bar{w}]$	$0,0,\bar{z}+1/2 [0,0,\bar{w}]$	
2 b $\bar{6}m'2$	$0,0,1/4 [0,0,0]$	$0,0,3/4 [0,0,0]$	
2 a $\bar{3}m'$	$0,0,0 [0,0,0]$	$0,0,1/2 [0,0,0]$	

Symmetry of special projections

Along [001] $6m'm'$	Along [100] $p2'mg'$	Along [210] $p2'mm'$
Origin at 0,0,z	$a^* = c$ Origin at x,0,0	$a^* = c/2$ Origin at x,x/2,0

$p6_3/mm'c'$

$6/mm'm'$

Hexagonal

No. 75.4.389

$p6_3/m2'/m'2'/c'$

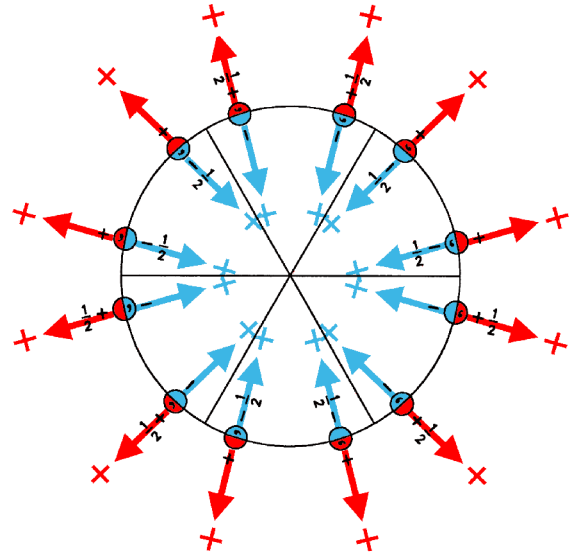
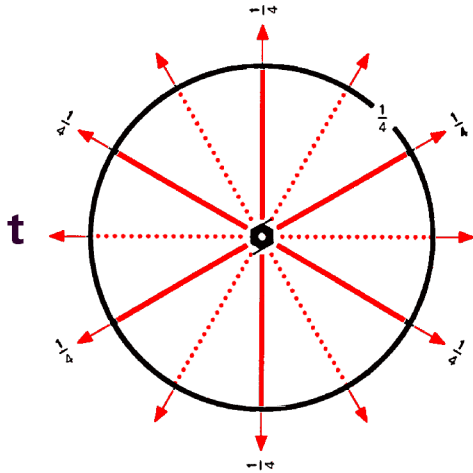

Origin at center ($\bar{3}m'1$) at $\bar{3}2'/m'c'$

Asymmetric unit $y \leq x/2$; $y \geq -x$; $0 \leq z \leq 1/4$

Symmetry operations

- | | | |
|---|---|---|
| (1) 1
(1 0,0,0) | (2) 3^+ 0,0,z
(3_z 0,0,0) | (3) 3^- 0,0,z
(3_z^{-1} 0,0,0) |
| (4) 2 (0,0,1/2) 0,0,z
(2_z 0,0,1/2) | (5) 6^- (0,0,1/2) 0,0,z
(6_z^{-1} 0,0,1/2) | (6) 6^+ (0,0,1/2) 0,0,z
(6_z 0,0,1/2) |
| (7) $2'$ x,x,0
(2_{xy} 0,0,0)' | (8) $2'$ x,0,0
(2_x 0,0,0)' | (9) $2'$ 0,y,0
(2_y 0,0,0)' |
| (10) $2'$ x, \bar{x} ,1/4
(2_3 0,0,1/2)' | (11) $2'$ x,2x,1/4
(2_2 0,0,1/2)' | (12) $2'$ 2x,x,1/4
(2_1 0,0,1/2)' |
| (13) $\bar{1}$ 0,0,0
($\bar{1}$ 0,0,0) | (14) $\bar{3}^+$ 0,0,z; 0,0,0
($\bar{3}_z$ 0,0,0) | (15) $\bar{3}^-$ 0,0,z; 0,0,0
($\bar{3}_z^{-1}$ 0,0,0) |
| (16) m x,y,1/4
(m_z 0,0,1/2) | (17) $\bar{6}^-$ 0,0,z; 0,0,1/4
($\bar{6}_z^{-1}$ 0,0,1/2) | (18) $\bar{6}^+$ 0,0,z; 0,0,1/4
($\bar{6}_z$ 0,0,1/2) |
| (19) m' x, \bar{x} ,z
(m_{xy} 0,0,0)' | (20) m' x,2x,z
(m_x 0,0,0)' | (21) m' 2x,x,z
(m_y 0,0,0)' |
| (22) c' (0,0,1/2) x,x,z
(m_3 0,0,1/2)' | (23) c' (0,0,1/2) x,0,z
(m_2 0,0,1/2)' | (24) c' (0,0,1/2) 0,y,z
(m_1 0,0,1/2)' |

Generators selected (1); $t(0,0,1)$; (2); (4); (7); (13)

Positions

	Coordinates		
Multiplicity, Wyckoff letter, Site symmetry			
24 h 1	(1) x,y,z [u,v,w]	(2) $\bar{y},x-y,z$ [$\bar{v},u-v,w$]	(3) $\bar{x}+y,\bar{x},z$ [$\bar{u}+v,\bar{u},w$]
	(4) $\bar{x},\bar{y},z+1/2$ [\bar{u},\bar{v},w]	(5) $y,\bar{x}+y,z+1/2$ [$v,\bar{u}+v,w$]	(6) $x-y,x,z+1/2$ [$u-v,u,w$]
	(7) y,x,\bar{z} [\bar{v},\bar{u},w]	(8) $x-y,\bar{y},\bar{z}$ [$\bar{u}+v,v,w$]	(9) $\bar{x},\bar{x}+y,\bar{z}$ [$u,u-v,w$]
	(10) $\bar{y},\bar{x},\bar{z}+1/2$ [v,u,w]	(11) $\bar{x}+y,y,\bar{z}+1/2$ [$u-v,\bar{v},w$]	(12) $x,x-y,\bar{z}+1/2$ [$\bar{u},\bar{u}+v,w$]
	(13) \bar{x},\bar{y},\bar{z} [u,v,w]	(14) $y,\bar{x}+y,\bar{z}$ [$\bar{v},u-v,w$]	(15) $x-y,x,\bar{z}$ [$\bar{u}+v,\bar{u},w$]
	(16) $x,y,\bar{z}+1/2$ [\bar{u},\bar{v},w]	(17) $\bar{y},x-y,\bar{z}+1/2$ [$v,\bar{u}+v,w$]	(18) $\bar{x}+y,\bar{x},\bar{z}+1/2$ [$u-v,u,w$]
	(19) \bar{y},\bar{x},z [\bar{v},\bar{u},w]	(20) $\bar{x}+y,y,z$ [$\bar{u}+v,v,w$]	(21) $x,x-y,z$ [$u,u-v,w$]
	(22) $y,x,z+1/2$ [v,u,w]	(23) $x-y,\bar{y},z+1/2$ [$u-v,\bar{v},w$]	(24) $\bar{x},\bar{x}+y,z+1/2$ [$\bar{u},\bar{u}+v,w$]
12 g .m'	$x,2x,z$ [$u,2u,w$]	$2\bar{x},\bar{x},z$ [$2\bar{u},\bar{u},w$]	x,\bar{x},z [u,\bar{u},w]
	$\bar{x},2\bar{x},z+1/2$ [$\bar{u},2\bar{u},w$]	$2x,x,z+1/2$ [$2u,u,w$]	$\bar{x},x,z+1/2$ [\bar{u},u,w]
	$2x,x,\bar{z}$ [$2\bar{u},\bar{u},w$]	$\bar{x},2\bar{x},\bar{z}$ [$u,2u,w$]	\bar{x},x,\bar{z} [u,\bar{u},w]
	$2\bar{x},\bar{x},\bar{z}+1/2$ [$2u,u,w$]	$x,2x,\bar{z}+1/2$ [$\bar{u},2\bar{u},w$]	$x,\bar{x},\bar{z}+1/2$ [\bar{u},u,w]
12 f m..	$x,y,1/4$ [$0,0,w$]	$\bar{y},x-y,1/4$ [$0,0,w$]	$\bar{x}+y,\bar{x},1/4$ [$0,0,w$]
	$\bar{x},\bar{y},3/4$ [$0,0,w$]	$y,\bar{x}+y,3/4$ [$0,0,w$]	$x-y,x,3/4$ [$0,0,w$]
	$y,x,3/4$ [$0,0,w$]	$x-y,\bar{y},3/4$ [$0,0,w$]	$\bar{x},\bar{x}+y,3/4$ [$0,0,w$]
	$\bar{y},\bar{x},1/4$ [$0,0,w$]	$\bar{x}+y,y,1/4$ [$0,0,w$]	$x,x-y,1/4$ [$0,0,w$]

Continued

No. 75.4.389

 $p6_3/mm'c'$

12 e .2'	$x,0,0 [u,2u,w]$	$0,x,0 [2\bar{u},\bar{u},w]$	$\bar{x},\bar{x},0 [u,\bar{u},w]$
	$\bar{x},0,1/2 [\bar{u},2\bar{u},w]$	$0,\bar{x},1/2 [2u,u,w]$	$x,x,1/2 [\bar{u},u,w]$
	$\bar{x},0,0 [u,2u,w]$	$0,\bar{x},0 [2\bar{u},\bar{u},w]$	$x,x,0 [u,\bar{u},w]$
	$x,0,1/2 [\bar{u},2\bar{u},w]$	$0,x,1/2 [2u,u,w]$	$\bar{x},\bar{x},1/2 [\bar{u},u,w]$
6 d $\bar{6}m'2'$	$x,2x,1/4 [0,0,w]$	$2\bar{x},\bar{x},1/4 [0,0,w]$	$x,\bar{x},1/4 [0,0,w]$
	$\bar{x},2\bar{x},3/4 [0,0,w]$	$2x,x,3/4 [0,0,w]$	$\bar{x},x,3/4 [0,0,w]$
4 c $3m'$	$0,0,z [0,0,w]$	$0,0,z+1/2 [0,0,w]$	
	$0,0,\bar{z} [0,0,w]$	$0,0,\bar{z}+1/2 [0,0,w]$	
2 b $\bar{6}m'2'$	$0,0,1/4 [0,0,w]$	$0,0,3/4 [0,0,w]$	
2 a $\bar{3}m'$	$0,0,0 [0,0,w]$	$0,0,1/2 [0,0,w]$	

Symmetry of special projections

Along [001] $\bar{6}m'm'$	Along [100] $p2'mg'$	Along [210] $p2'mm'$
Origin at 0,0,z	$a^* = c$ Origin at x,0,0	$a^* = c/2$ Origin at x,x/2,0

$p6_3/m'mc$

$6/m'mm$

Hexagonal

No. 75.5.390

$p6_3/m^2/m2'/c$

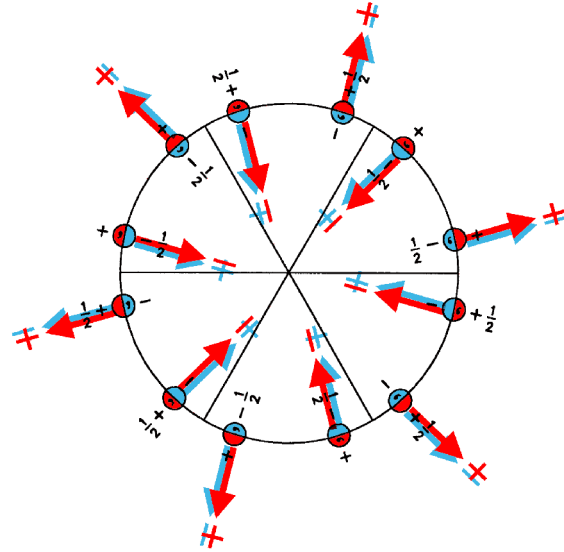
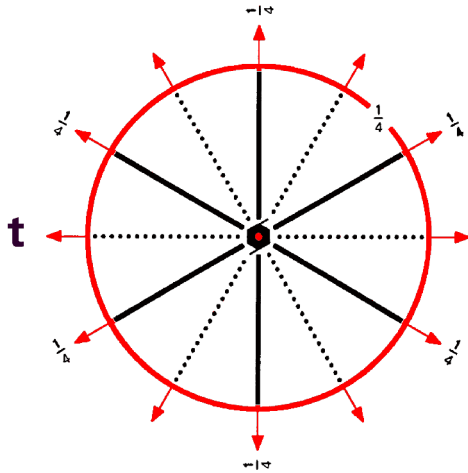

Origin at center ($\bar{3}'m1$) at $\bar{3}'2'/mc$

Asymmetric unit $y \leq x/2$; $y \geq -x$; $0 \leq z \leq 1/4$

Symmetry operations

- | | | |
|---|--|--|
| (1) 1
(1 0,0,0) | (2) 3^+ 0,0,z
(3_z 0,0,0) | (3) 3^- 0,0,z
(3_z^{-1} 0,0,0) |
| (4) 2 (0,0,1/2) 0,0,z
(2_z 0,0,1/2) | (5) 6^- (0,0,1/2) 0,0,z
(6_z^{-1} 0,0,1/2) | (6) 6^+ (0,0,1/2) 0,0,z
(6_z 0,0,1/2) |
| (7) $2'$ x,x,0
(2_{xy} 0,0,0)' | (8) $2'$ x,0,0
(2_x 0,0,0)' | (9) $2'$ 0,y,0
(2_y 0,0,0)' |
| (10) $2'$ x, \bar{x} ,1/4
(2_3 0,0,1/2)' | (11) $2'$ x,2x,1/4
(2_2 0,0,1/2)' | (12) $2'$ 2x,x,1/4
(2_1 0,0,1/2)' |
| (13) $\bar{1}$ 0,0,0
($\bar{1}$ 0,0,0)' | (14) $\bar{3}^+$ 0,0,z; 0,0,0
($\bar{3}_z$ 0,0,0)' | (15) $\bar{3}^-$ 0,0,z; 0,0,0
($\bar{3}_z^{-1}$ 0,0,0)' |
| (16) m' x,y,1/4
(m_z 0,0,1/2)' | (17) $\bar{6}^-$ 0,0,z; 0,0,1/4
($\bar{6}_z^{-1}$ 0,0,1/2)' | (18) $\bar{6}^+$ 0,0,z; 0,0,1/4
($\bar{6}_z$ 0,0,1/2)' |
| (19) m x, \bar{x} ,z
(m_{xy} 0,0,0) | (20) m x,2x,z
(m_x 0,0,0) | (21) m 2x,x,z
(m_y 0,0,0) |
| (22) c (0,0,1/2) x,x,z
(m_3 0,0,1/2) | (23) c (0,0,1/2) x,0,z
(m_2 0,0,1/2) | (24) c (0,0,1/2) 0,y,z
(m_1 0,0,1/2) |

Generators selected (1); $t(0,0,1)$; (2); (4); (7); (13)

Positions

	Coordinates		
Multiplicity, Wyckoff letter, Site symmetry			
24 h 1	(1) x,y,z [u,v,w]	(2) $\bar{y},x-y,z$ [$\bar{v},u-v,w$]	(3) $\bar{x}+y,\bar{x},z$ [$\bar{u}+v,\bar{u},w$]
	(4) $\bar{x},\bar{y},z+1/2$ [\bar{u},\bar{v},w]	(5) $y,\bar{x}+y,z+1/2$ [$v,\bar{u}+v,w$]	(6) $x-y,x,z+1/2$ [$u-v,u,w$]
	(7) y,x,\bar{z} [\bar{v},\bar{u},w]	(8) $x-y,\bar{y},\bar{z}$ [$\bar{u}+v,v,w$]	(9) $\bar{x},\bar{x}+y,\bar{z}$ [$u,u-v,w$]
	(10) $\bar{y},\bar{x},\bar{z}+1/2$ [v,u,w]	(11) $\bar{x}+y,y,\bar{z}+1/2$ [$u-v,\bar{v},w$]	(12) $x,x-y,\bar{z}+1/2$ [$\bar{u},\bar{u}+v,w$]
	(13) \bar{x},\bar{y},\bar{z} [\bar{u},\bar{v},\bar{w}]	(14) $y,\bar{x}+y,\bar{z}$ [$v,\bar{u}+v,\bar{w}$]	(15) $x-y,x,\bar{z}$ [$u-v,u,\bar{w}$]
	(16) $x,y,\bar{z}+1/2$ [u,v,\bar{w}]	(17) $\bar{y},x-y,\bar{z}+1/2$ [$\bar{v},u-v,\bar{w}$]	(18) $\bar{x}+y,\bar{x},\bar{z}+1/2$ [$\bar{u}+v,\bar{u},\bar{w}$]
	(19) \bar{y},\bar{x},z [v,u,\bar{w}]	(20) $\bar{x}+y,y,z$ [$u-v,\bar{v},\bar{w}$]	(21) $x,x-y,z$ [$\bar{u},\bar{u}+v,\bar{w}$]
	(22) $y,x,z+1/2$ [\bar{v},\bar{u},\bar{w}]	(23) $x-y,\bar{y},z+1/2$ [$\bar{u}+v,v,\bar{w}$]	(24) $\bar{x},\bar{x}+y,z+1/2$ [$u,u-v,\bar{w}$]
12 g .m.	$x,2x,z$ [$u,0,0$]	$2\bar{x},\bar{x},z$ [$0,u,0$]	x,\bar{x},z [$\bar{u},\bar{u},0$]
	$\bar{x},2\bar{x},z+1/2$ [$\bar{u},0,0$]	$2x,x,z+1/2$ [$0,\bar{u},0$]	$\bar{x},x,z+1/2$ [$u,u,0$]
	$2x,x,\bar{z}$ [$0,\bar{u},0$]	$\bar{x},2\bar{x},\bar{z}$ [$\bar{u},0,0$]	\bar{x},x,\bar{z} [$u,u,0$]
	$2\bar{x},\bar{x},\bar{z}+1/2$ [$0,u,0$]	$x,2x,\bar{z}+1/2$ [$u,0,0$]	$x,\bar{x},\bar{z}+1/2$ [$\bar{u},\bar{u},0$]
12 f m'..	$x,y,1/4$ [$u,v,0$]	$\bar{y},x-y,1/4$ [$\bar{v},u-v,0$]	$\bar{x}+y,\bar{x},1/4$ [$\bar{u}+v,\bar{u},0$]
	$\bar{x},\bar{y},3/4$ [$\bar{u},\bar{v},0$]	$y,\bar{x}+y,3/4$ [$v,\bar{u}+v,0$]	$x-y,x,3/4$ [$u-v,u,0$]
	$y,x,3/4$ [$\bar{v},\bar{u},0$]	$x-y,\bar{y},3/4$ [$\bar{u}+v,v,0$]	$\bar{x},\bar{x}+y,3/4$ [$u,u-v,0$]
	$\bar{y},\bar{x},1/4$ [$v,u,0$]	$\bar{x}+y,y,1/4$ [$u-v,\bar{v},0$]	$x,x-y,1/4$ [$\bar{u},\bar{u}+v,0$]

Continued

No. 75.5.390

 $\rho 6_3/m'mc$

12 e .2'	$x,0,0 [u,2u,w]$	$0,x,0 [2\bar{u},\bar{u},w]$	$\bar{x},\bar{x},0 [u,\bar{u},w]$
	$\bar{x},0,1/2 [\bar{u},2\bar{u},w]$	$0,\bar{x},1/2 [2u,u,w]$	$x,x,1/2 [\bar{u},u,w]$
	$\bar{x},0,0 [\bar{u},2\bar{u},\bar{w}]$	$0,\bar{x},0 [2u,u,\bar{w}]$	$x,x,0 [\bar{u},u,\bar{w}]$
	$x,0,1/2 [u,2u,\bar{w}]$	$0,x,1/2 [2\bar{u},\bar{u},\bar{w}]$	$\bar{x},\bar{x},1/2 [u,\bar{u},\bar{w}]$
6 d $m'm2'$	$x,2x,1/4 [u,0,0]$	$2\bar{x},\bar{x},1/4 [0,u,0]$	$x,\bar{x},1/4 [\bar{u},\bar{u},0]$
	$\bar{x},2\bar{x},3/4 [\bar{u},0,0]$	$2x,x,3/4 [0,\bar{u},0]$	$\bar{x},x,3/4 [u,u,0]$
4 c $3m.$	$0,0,z [0,0,0]$	$0,0,z+1/2 [0,0,0]$	
	$0,0,\bar{z} [0,0,0]$	$0,0,\bar{z}+1/2 [0,0,0]$	
2 b $\bar{6}'m2'$	$0,0,1/4 [0,0,0]$	$0,0,3/4 [0,0,0]$	
2 a $\bar{3}'m.$	$0,0,0 [0,0,0]$	$0,0,1/2 [0,0,0]$	

Symmetry of special projections

Along [001] $6mm1'$	Along [100] $\rho 2mg1'$	Along [210] $\rho_{2a^*}2mm$
Origin at $0,0,z$	$a^* = c$ Origin at $x,0,0$	$a^* = c/2$ Origin at $x,x/2,0$

$\rho 6_3'/m'c'$

$6'/m'mm'$

Hexagonal

No. 75.6.391

$\rho 6_3'/m'2/m2'/c'$

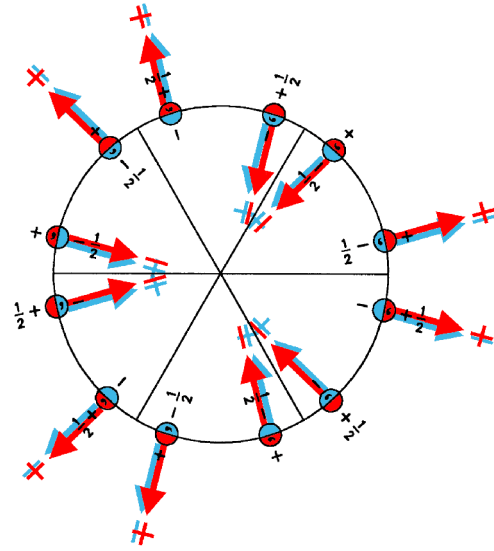
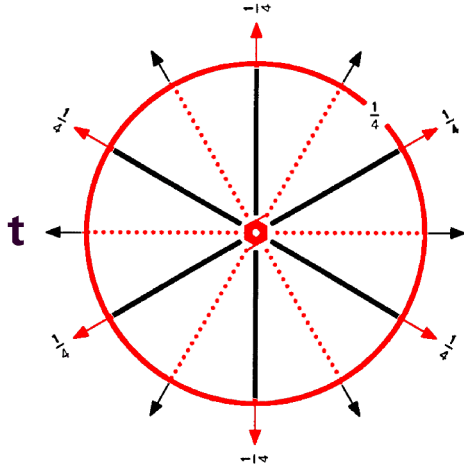

Origin at center ($\bar{3}m1$) at $\bar{3}2/mc'$

Asymmetric unit $y \leq x/2$; $y \geq -x$; $0 \leq z \leq 1/4$

Symmetry operations

- | | | |
|---|--|---|
| (1) 1
(1 0,0,0) | (2) 3^+ 0,0,z
(3_z 0,0,0) | (3) 3^- 0,0,z
(3_z^{-1} 0,0,0) |
| (4) $2'$ (0,0,1/2) 0,0,z
(2_z 0,0,1/2)' | (5) 6^- (0,0,1/2) 0,0,z
(6_z^{-1} 0,0,1/2)' | (6) 6^+ (0,0,1/2) 0,0,z
(6_z 0,0,1/2)' |
| (7) 2 x,x,0
(2_{xy} 0,0,0) | (8) 2 x,0,0
(2_x 0,0,0) | (9) 2 0,y,0
(2_y 0,0,0) |
| (10) $2'$ x, \bar{x} ,1/4
(2_3 0,0,1/2)' | (11) $2'$ x,2x,1/4
(2_2 0,0,1/2)' | (12) $2'$ 2x,x,1/4
(2_1 0,0,1/2)' |
| (13) $\bar{1}$ 0,0,0
($\bar{1}$ 0,0,0) | (14) $\bar{3}^+$ 0,0,z; 0,0,0
($\bar{3}_z$ 0,0,0) | (15) $\bar{3}^-$ 0,0,z; 0,0,0
($\bar{3}_z^{-1}$ 0,0,0) |
| (16) m' x,y,1/4
(m_z 0,0,1/2)' | (17) $\bar{6}^-$ 0,0,z; 0,0,1/4
($\bar{6}_z^{-1}$ 0,0,1/2)' | (18) $\bar{6}^+$ 0,0,z; 0,0,1/4
($\bar{6}_z$ 0,0,1/2)' |
| (19) m x, \bar{x} ,z
(m_{xy} 0,0,0) | (20) m x,2x,z
(m_x 0,0,0) | (21) m 2x,x,z
(m_y 0,0,0) |
| (22) c' (0,0,1/2) x,x,z
(m_3 0,0,1/2)' | (23) c' (0,0,1/2) x,0,z
(m_2 0,0,1/2)' | (24) c' (0,0,1/2) 0,y,z
(m_1 0,0,1/2)' |

Generators selected (1); t(0,0,1); (2); (4); (7); (13)

Positions

	Coordinates		
Multiplicity, Wyckoff letter, Site symmetry			
24 h 1	(1) x,y,z [u,v,w]	(2) $\bar{y},x-y,z$ [$\bar{v},u-v,w$]	(3) $\bar{x}+y,\bar{x},z$ [$\bar{u}+v,\bar{u},w$]
	(4) $\bar{x},\bar{y},z+1/2$ [u,v, \bar{w}]	(5) $y,\bar{x}+y,z+1/2$ [$\bar{v},u-v,\bar{w}$]	(6) $x-y,x,z+1/2$ [$\bar{u}+v,\bar{u},\bar{w}$]
	(7) y,x,\bar{z} [v,u, \bar{w}]	(8) $x-y,\bar{y},\bar{z}$ [u-v, \bar{v},\bar{w}]	(9) $\bar{x},\bar{x}+y,\bar{z}$ [$\bar{u},\bar{u}+v,\bar{w}$]
	(10) $\bar{y},\bar{x},\bar{z}+1/2$ [v,u,w]	(11) $\bar{x}+y,y,\bar{z}+1/2$ [u-v, \bar{v},w]	(12) $x,x-y,\bar{z}+1/2$ [$\bar{u},\bar{u}+v,w$]
	(13) \bar{x},\bar{y},\bar{z} [u,v,w]	(14) $y,\bar{x}+y,\bar{z}$ [$\bar{v},u-v,w$]	(15) $x-y,x,\bar{z}$ [$\bar{u}+v,\bar{u},w$]
	(16) $x,y,\bar{z}+1/2$ [u,v, \bar{w}]	(17) $\bar{y},x-y,\bar{z}+1/2$ [$\bar{v},u-v,\bar{w}$]	(18) $\bar{x}+y,\bar{x},\bar{z}+1/2$ [$\bar{u}+v,\bar{u},\bar{w}$]
	(19) \bar{y},\bar{x},z [v,u, \bar{w}]	(20) $\bar{x}+y,y,z$ [u-v, \bar{v},\bar{w}]	(21) $x,x-y,z$ [$\bar{u},\bar{u}+v,\bar{w}$]
	(22) $y,x,z+1/2$ [v,u,w]	(23) $x-y,\bar{y},z+1/2$ [u-v, \bar{v},w]	(24) $\bar{x},\bar{x}+y,z+1/2$ [$\bar{u},\bar{u}+v,w$]
12 g .m.	$x,2x,z$ [u,0,0]	$2\bar{x},\bar{x},z$ [0,u,0]	x,\bar{x},z [$\bar{u},\bar{u},0$]
	$\bar{x},2\bar{x},z+1/2$ [u,0,0]	$2x,x,z+1/2$ [0,u,0]	$\bar{x},x,z+1/2$ [$\bar{u},\bar{u},0$]
	$2x,x,\bar{z}$ [0,u,0]	$\bar{x},2\bar{x},\bar{z}$ [u,0,0]	\bar{x},x,\bar{z} [$\bar{u},\bar{u},0$]
	$2\bar{x},\bar{x},\bar{z}+1/2$ [0,u,0]	$x,2x,\bar{z}+1/2$ [u,0,0]	$x,\bar{x},\bar{z}+1/2$ [$\bar{u},\bar{u},0$]
12 f m'..	$x,y,1/4$ [u,v,0]	$\bar{y},x-y,1/4$ [$\bar{v},u-v,0$]	$\bar{x}+y,\bar{x},1/4$ [$\bar{u}+v,\bar{u},0$]
	$\bar{x},\bar{y},3/4$ [u,v,0]	$y,\bar{x}+y,3/4$ [$\bar{v},u-v,0$]	$x-y,x,3/4$ [$\bar{u}+v,\bar{u},0$]
	$y,x,3/4$ [v,u,0]	$x-y,\bar{y},3/4$ [u-v, $\bar{v},0$]	$\bar{x},\bar{x}+y,3/4$ [$\bar{u},\bar{u}+v,0$]
	$\bar{y},\bar{x},1/4$ [v,u,0]	$\bar{x}+y,y,1/4$ [u-v, $\bar{v},0$]	$x,x-y,1/4$ [$\bar{u},\bar{u}+v,0$]

Continued

No. 75.6.391

 $p6_3/m'mc'$

12 e .2.	$x,0,0 [u,0,0]$	$0,x,0 [0,u,0]$	$\bar{x},\bar{x},0 [\bar{u},\bar{u},0]$
	$\bar{x},0,1/2 [u,0,0]$	$0,\bar{x},1/2 [0,u,0]$	$x,x,1/2 [\bar{u},\bar{u},0]$
	$\bar{x},0,0 [u,0,0]$	$0,\bar{x},0 [0,u,0]$	$x,x,0 [\bar{u},\bar{u},0]$
	$x,0,1/2 [u,0,0]$	$0,x,1/2 [0,u,0]$	$\bar{x},\bar{x},1/2 [\bar{u},\bar{u},0]$
6 d $m'm2'$	$x,2x,1/4 [u,0,0]$	$2\bar{x},\bar{x},1/4 [0,u,0]$	$x,\bar{x},1/4 [\bar{u},\bar{u},0]$
	$\bar{x},2\bar{x},3/4 [u,0,0]$	$2x,x,3/4 [0,u,0]$	$\bar{x},x,3/4 [\bar{u},\bar{u},0]$
4 c $3m.$	$0,0,z [0,0,0]$	$0,0,z+1/2 [0,0,0]$	
	$0,0,\bar{z} [0,0,0]$	$0,0,\bar{z}+1/2 [0,0,0]$	
2 b $\bar{6}'m2'$	$0,0,1/4 [0,0,0]$	$0,0,3/4 [0,0,0]$	
2 a $\bar{3}m.$	$0,0,0 [0,0,0]$	$0,0,1/2 [0,0,0]$	

Symmetry of special projections

Along [001] $6mm1'$	Along [100] $p2mg1'$	Along [210] $p2'm'm$
Origin at 0,0,z	$a^* = c$ Origin at x,0,0	$a^* = c/2$ Origin at x,x/2,0

$p6_3'/m'm'c$

$6'/m'm'm$

Hexagonal

No. 75.7.392

$p6_3'/m'2'/m'2'/c$

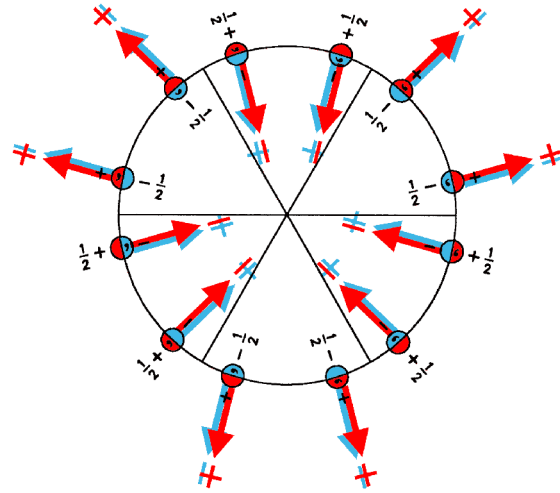
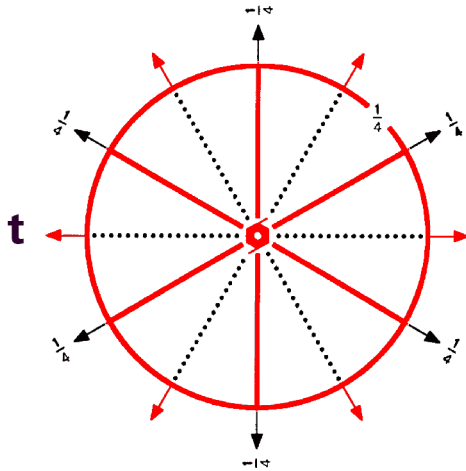

Origin at center ($\bar{3}m'1$) at $\bar{3}2'/m'c$

Asymmetric unit $y \leq x/2; y \geq -x; 0 \leq z \leq 1/4$

Symmetry operations

- | | | |
|--|--|---|
| (1) 1
(1 0,0,0) | (2) 3^+ 0,0,z
(3_z 0,0,0) | (3) 3^- 0,0,z
(3_z^{-1} 0,0,0) |
| (4) $2'$ (0,0,1/2) 0,0,z
(2_z 0,0,1/2)' | (5) 6^- (0,0,1/2) 0,0,z
(6_z^{-1} 0,0,1/2)' | (6) 6^+ (0,0,1/2) 0,0,z
(6_z 0,0,1/2)' |
| (7) $2'$ x,x,0
(2_{xy} 0,0,0)' | (8) $2'$ x,0,0
(2_x 0,0,0)' | (9) $2'$ 0,y,0
(2_y 0,0,0)' |
| (10) 2 x, \bar{x} ,1/4
(2_3 0,0,1/2) | (11) 2 x,2x,1/4
(2_2 0,0,1/2) | (12) 2 2x,x,1/4
(2_1 0,0,1/2) |
| (13) $\bar{1}$ 0,0,0
($\bar{1}$ 0,0,0) | (14) $\bar{3}^+$ 0,0,z; 0,0,0
($\bar{3}_z$ 0,0,0) | (15) $\bar{3}^-$ 0,0,z; 0,0,0
($\bar{3}_z^{-1}$ 0,0,0) |
| (16) m' x,y,1/4
(m_z 0,0,1/2)' | (17) $\bar{6}^-$ 0,0,z; 0,0,1/4
($\bar{6}_z^{-1}$ 0,0,1/2)' | (18) $\bar{6}^+$ 0,0,z; 0,0,1/4
($\bar{6}_z$ 0,0,1/2)' |
| (19) m' x, \bar{x} ,z
(m_{xy} 0,0,0)' | (20) m' x,2x,z
(m_x 0,0,0)' | (21) m' 2x,x,z
(m_y 0,0,0)' |
| (22) c (0,0,1/2) x,x,z
(m_3 0,0,1/2) | (23) c (0,0,1/2) x,0,z
(m_2 0,0,1/2) | (24) c (0,0,1/2) 0,y,z
(m_1 0,0,1/2) |

Generators selected (1); t(0,0,1); (2); (4); (7); (13)

Positions

	Coordinates		
Multiplicity, Wyckoff letter, Site symmetry			
24 h 1	(1) x,y,z [u,v,w]	(2) $\bar{y},x-y,z$ [$\bar{v},u-v,w$]	(3) $\bar{x}+y,\bar{x},z$ [$\bar{u}+v,\bar{u},w$]
	(4) $\bar{x},\bar{y},z+1/2$ [u,v, \bar{w}]	(5) $y,\bar{x}+y,z+1/2$ [$\bar{v},u-v,\bar{w}$]	(6) x-y,x,z+1/2 [$\bar{u}+v,\bar{u},\bar{w}$]
	(7) y,x, \bar{z} [\bar{v},\bar{u},w]	(8) x-y, \bar{y},\bar{z} [$\bar{u}+v,v,w$]	(9) $\bar{x},\bar{x}+y,\bar{z}$ [u,u-v,w]
	(10) $\bar{y},\bar{x},\bar{z}+1/2$ [\bar{v},\bar{u},\bar{w}]	(11) $\bar{x}+y,y,\bar{z}+1/2$ [$\bar{u}+v,v,\bar{w}$]	(12) x,x-y, $\bar{z}+1/2$ [u,u-v, \bar{w}]
	(13) \bar{x},\bar{y},\bar{z} [u,v,w]	(14) $y,\bar{x}+y,\bar{z}$ [$\bar{v},u-v,w$]	(15) x-y,x, \bar{z} [$\bar{u}+v,\bar{u},w$]
	(16) x,y, $\bar{z}+1/2$ [u,v, \bar{w}]	(17) $\bar{y},x-y,\bar{z}+1/2$ [$\bar{v},u-v,\bar{w}$]	(18) $\bar{x}+y,\bar{x},\bar{z}+1/2$ [$\bar{u}+v,\bar{u},\bar{w}$]
	(19) \bar{y},\bar{x},z [\bar{v},\bar{u},w]	(20) $\bar{x}+y,y,z$ [$\bar{u}+v,v,w$]	(21) x,x-y,z [u,u-v,w]
	(22) y,x,z+1/2 [\bar{v},\bar{u},\bar{w}]	(23) x-y, $\bar{y},z+1/2$ [$\bar{u}+v,v,\bar{w}$]	(24) $\bar{x},\bar{x}+y,z+1/2$ [u,u-v, \bar{w}]
12 g .m'.	x,2x,z [u,2u,w]	2 \bar{x},\bar{x},z [2 \bar{u},\bar{u},w]	x, \bar{x},z [u, \bar{u},w]
	$\bar{x},2\bar{x},z+1/2$ [u,2u, \bar{w}]	2x,x,z+1/2 [2 \bar{u},\bar{u},\bar{w}]	$\bar{x},x,z+1/2$ [u, \bar{u},\bar{w}]
	2x,x, \bar{z} [2 \bar{u},\bar{u},w]	$\bar{x},2\bar{x},\bar{z}$ [u,2u,w]	\bar{x},x,\bar{z} [u, \bar{u},w]
	2 $\bar{x},\bar{x},\bar{z}+1/2$ [2 \bar{u},\bar{u},\bar{w}]	x,2x, $\bar{z}+1/2$ [u,2u, \bar{w}]	x, $\bar{x},\bar{z}+1/2$ [u, \bar{u},\bar{w}]
12 f m'..	x,y,1/4 [u,v,0]	$\bar{y},x-y,1/4$ [$\bar{v},u-v,0$]	$\bar{x}+y,\bar{x},1/4$ [$\bar{u}+v,\bar{u},0$]
	$\bar{x},\bar{y},3/4$ [u,v,0]	y, $\bar{x}+y,3/4$ [$\bar{v},u-v,0$]	x-y,x,3/4 [$\bar{u}+v,\bar{u},0$]
	y,x,3/4 [$\bar{v},\bar{u},0$]	x-y, $\bar{y},3/4$ [$\bar{u}+v,v,0$]	$\bar{x},\bar{x}+y,3/4$ [u,u-v,0]
	$\bar{y},\bar{x},1/4$ [$\bar{v},\bar{u},0$]	$\bar{x}+y,y,1/4$ [$\bar{u}+v,v,0$]	x,x-y,1/4 [u,u-v,0]

Continued

No. 75.7.392

 $\rho 6_3$ 'm'm'c

12 e .2'	x,0,0 [u,2u,w]	0,x,0 [2 \bar{u} , \bar{u} ,w]	$\bar{x},\bar{x},0$ [u, \bar{u} ,w]
	$\bar{x},0,1/2$ [u,2u, \bar{w}]	0, $\bar{x},1/2$ [2 \bar{u} , \bar{u} , \bar{w}]	x,x,1/2 [u, \bar{u} , \bar{w}]
	$\bar{x},0,0$ [u,2u,w]	0, $\bar{x},0$ [2 \bar{u} , \bar{u} ,w]	x,x,0 [u, \bar{u} ,w]
	x,0,1/2 [u,2u, \bar{w}]	0,x,1/2 [2 \bar{u} , \bar{u} , \bar{w}]	$\bar{x},\bar{x},1/2$ [u, \bar{u} , \bar{w}]
6 d m'm'2	x,2x,1/4 [u,2u,0]	2 $\bar{x},\bar{x},1/4$ [2 \bar{u} , \bar{u} ,0]	x, $\bar{x},1/4$ [u, \bar{u} ,0]
	$\bar{x},2\bar{x},3/4$ [u,2u,0]	2x,x,3/4 [2 \bar{u} , \bar{u} ,0]	$\bar{x},x,3/4$ [u, \bar{u} ,0]
4 c 3m'	0,0,z [0,0,w]	0,0,z+1/2 [0,0, \bar{w}]	
	0,0, \bar{z} [0,0,w]	0,0, \bar{z} +1/2 [0,0, \bar{w}]	
2 b $\bar{6}$ 'm'2	0,0,1/4 [0,0,0]	0,0,3/4 [0,0,0]	
2 a $\bar{3}$ m'	0,0,0 [0,0,w]	0,0,1/2 [0,0, \bar{w}]	

Symmetry of special projections

Along [001] $6mm1'$	Along [100] $\rho 2'm'g$	Along [210] $\rho_{2a^*} 2'mm'$
Origin at 0,0,z	$a^* = c$ Origin at x,0,0	$a^* = c/2$ Origin at x,x/2,0

$p6_3'/mmc'$

$6'/mmm'$

Hexagonal

No. 75.8.393

$p6_3'/m2'/m2'/c'$

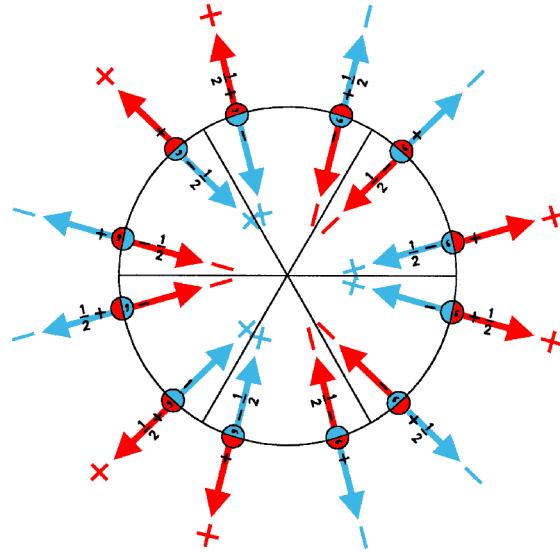
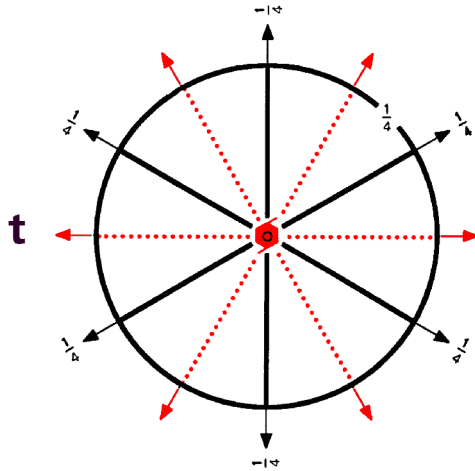

Origin at center ($\bar{3}'m1$) at $\bar{3}'2'/mc'$

Asymmetric unit $y \leq x/2$; $y \geq -x$; $0 \leq z \leq 1/4$

Symmetry operations

- | | | |
|---|---|--|
| (1) 1
(1 0,0,0) | (2) 3^+ 0,0,z
(3_z 0,0,0) | (3) 3^- 0,0,z
(3_z^{-1} 0,0,0) |
| (4) $2'$ (0,0,1/2) 0,0,z
(2_z 0,0,1/2)' | (5) 6^- (0,0,1/2) 0,0,z
(6_z^{-1} 0,0,1/2)' | (6) 6^+ (0,0,1/2) 0,0,z
(6_z 0,0,1/2)' |
| (7) $2'$ x,x,0
(2_{xy} 0,0,0)' | (8) $2'$ x,0,0
(2_x 0,0,0)' | (9) $2'$ 0,y,0
(2_y 0,0,0)' |
| (10) 2 x, \bar{x} ,1/4
(2_3 0,0,1/2) | (11) 2 x,2x,1/4
(2_2 0,0,1/2) | (12) 2 2x,x,1/4
(2_1 0,0,1/2) |
| (13) $\bar{1}$ 0,0,0
($\bar{1}$ 0,0,0)' | (14) $\bar{3}^+$ 0,0,z; 0,0,0
($\bar{3}_z$ 0,0,0)' | (15) $\bar{3}^-$ 0,0,z; 0,0,0
($\bar{3}_z^{-1}$ 0,0,0)' |
| (16) m x,y,1/4
(m_z 0,0,1/2) | (17) $\bar{6}^-$ 0,0,z; 0,0,1/4
($\bar{6}_z^{-1}$ 0,0,1/2) | (18) $\bar{6}^+$ 0,0,z; 0,0,1/4
($\bar{6}_z$ 0,0,1/2) |
| (19) m x, \bar{x} ,z
(m_{xy} 0,0,0) | (20) m x,2x,z
(m_x 0,0,0) | (21) m 2x,x,z
(m_y 0,0,0) |
| (22) c' (0,0,1/2) x,x,z
(m_3 0,0,1/2)' | (23) c' (0,0,1/2) x,0,z
(m_2 0,0,1/2)' | (24) c' (0,0,1/2) 0,y,z
(m_1 0,0,1/2)' |

Generators selected (1); $t(0,0,1)$; (2); (4); (7); (13)

Positions

	Coordinates		
Multiplicity, Wyckoff letter, Site symmetry			
24 h 1	(1) x,y,z [u,v,w]	(2) $\bar{y},x-y,z$ [$\bar{v},u-v,w$]	(3) $\bar{x}+y,\bar{x},z$ [$\bar{u}+v,\bar{u},w$]
	(4) $\bar{x},\bar{y},z+1/2$ [u,v,\bar{w}]	(5) $y,\bar{x}+y,z+1/2$ [$\bar{v},u-v,\bar{w}$]	(6) $x-y,x,z+1/2$ [$\bar{u}+v,\bar{u},\bar{w}$]
	(7) y,x,\bar{z} [\bar{v},\bar{u},w]	(8) $x-y,\bar{y},\bar{z}$ [$\bar{u}+v,v,w$]	(9) $\bar{x},\bar{x}+y,\bar{z}$ [$u,u-v,w$]
	(10) $\bar{y},\bar{x},\bar{z}+1/2$ [\bar{v},\bar{u},\bar{w}]	(11) $\bar{x}+y,y,\bar{z}+1/2$ [$\bar{u}+v,v,\bar{w}$]	(12) $x,x-y,\bar{z}+1/2$ [$u,u-v,\bar{w}$]
	(13) \bar{x},\bar{y},\bar{z} [\bar{u},\bar{v},\bar{w}]	(14) $y,\bar{x}+y,\bar{z}$ [$v,\bar{u}+v,\bar{w}$]	(15) $x-y,x,\bar{z}$ [$u-v,u,\bar{w}$]
	(16) $x,y,\bar{z}+1/2$ [\bar{u},\bar{v},w]	(17) $\bar{y},x-y,\bar{z}+1/2$ [$v,\bar{u}+v,w$]	(18) $\bar{x}+y,\bar{x},\bar{z}+1/2$ [$u-v,u,w$]
	(19) \bar{y},\bar{x},z [v,u,\bar{w}]	(20) $\bar{x}+y,y,z$ [$u-v,\bar{v},\bar{w}$]	(21) $x,x-y,z$ [$\bar{u},\bar{u}+v,\bar{w}$]
	(22) $y,x,z+1/2$ [v,u,w]	(23) $x-y,\bar{y},z+1/2$ [$u-v,\bar{v},w$]	(24) $\bar{x},\bar{x}+y,z+1/2$ [$\bar{u},\bar{u}+v,w$]
12 g .m.	$x,2x,z$ [$u,0,0$]	$2\bar{x},\bar{x},z$ [$0,u,0$]	x,\bar{x},z [$\bar{u},\bar{u},0$]
	$\bar{x},2\bar{x},z+1/2$ [$u,0,0$]	$2x,x,z+1/2$ [$0,u,0$]	$\bar{x},x,z+1/2$ [$\bar{u},\bar{u},0$]
	$2x,x,\bar{z}$ [$0,\bar{u},0$]	$\bar{x},2\bar{x},\bar{z}$ [$\bar{u},0,0$]	\bar{x},x,\bar{z} [$u,u,0$]
	$2\bar{x},\bar{x},\bar{z}+1/2$ [$0,\bar{u},0$]	$x,2x,\bar{z}+1/2$ [$\bar{u},0,0$]	$x,\bar{x},\bar{z}+1/2$ [$u,u,0$]
12 f m..	$x,y,1/4$ [$0,0,w$]	$\bar{y},x-y,1/4$ [$0,0,w$]	$\bar{x}+y,\bar{x},1/4$ [$0,0,w$]
	$\bar{x},\bar{y},3/4$ [$0,0,\bar{w}$]	$y,\bar{x}+y,3/4$ [$0,0,\bar{w}$]	$x-y,x,3/4$ [$0,0,\bar{w}$]
	$y,x,3/4$ [$0,0,w$]	$x-y,\bar{y},3/4$ [$0,0,w$]	$\bar{x},\bar{x}+y,3/4$ [$0,0,w$]
	$\bar{y},\bar{x},1/4$ [$0,0,\bar{w}$]	$\bar{x}+y,y,1/4$ [$0,0,\bar{w}$]	$x,x-y,1/4$ [$0,0,\bar{w}$]

Continued

No. 75.8.393

 $p6_3$ '1mmc'

12 e .2'	$x,0,0$ [$u,2u,w$]	$0,x,0$ [$2\bar{u},\bar{u},w$]	$\bar{x},\bar{x},0$ [u,\bar{u},w]
	$\bar{x},0,1/2$ [$u,2u,\bar{w}$]	$0,\bar{x},1/2$ [$2\bar{u},\bar{u},\bar{w}$]	$x,x,1/2$ [u,\bar{u},\bar{w}]
	$\bar{x},0,0$ [$\bar{u},2\bar{u},\bar{w}$]	$0,\bar{x},0$ [$2u,u,\bar{w}$]	$x,x,0$ [\bar{u},u,\bar{w}]
	$x,0,1/2$ [$\bar{u},2\bar{u},w$]	$0,x,1/2$ [$2u,u,w$]	$\bar{x},\bar{x},1/2$ [\bar{u},u,w]
6 d mm ²	$x,2x,1/4$ [$0,0,0$]	$2\bar{x},\bar{x},1/4$ [$0,0,0$]	$x,\bar{x},1/4$ [$0,0,0$]
	$\bar{x},2\bar{x},3/4$ [$0,0,0$]	$2x,x,3/4$ [$0,0,0$]	$\bar{x},x,3/4$ [$0,0,0$]
4 c 3m.	$0,0,z$ [$0,0,0$]	$0,0,z+1/2$ [$0,0,0$]	
	$0,0,\bar{z}$ [$0,0,0$]	$0,0,\bar{z}+1/2$ [$0,0,0$]	
2 b $\bar{6}m2$	$0,0,1/4$ [$0,0,0$]	$0,0,3/4$ [$0,0,0$]	
2 a $\bar{3}m.$	$0,0,0$ [$0,0,0$]	$0,0,1/2$ [$0,0,0$]	

Symmetry of special projections

Along [001] $6'mm'$ Origin at $0,0,z$ Along [100] $p2mg1'$ $a^* = c$ Origin at $x,0,0$ Along [210] $p2mm$ $a^* = c/2$ Origin at $x,x/2,0$

$\rho 6_3'/mm'c$

$6'/mm'm$

Hexagonal

No. 75.9.394

$\rho 6_3'/m2/m'2'/c$

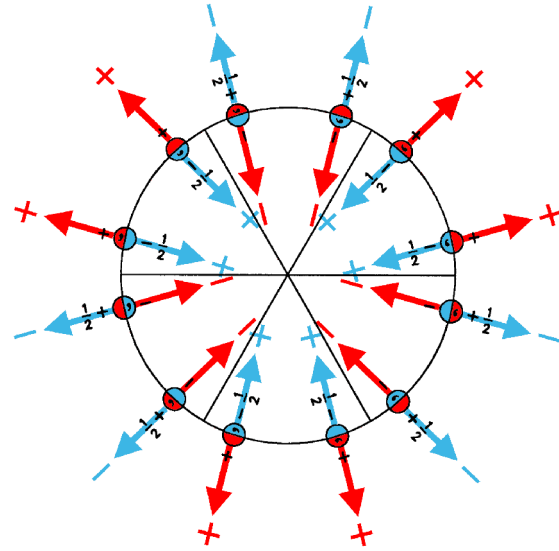
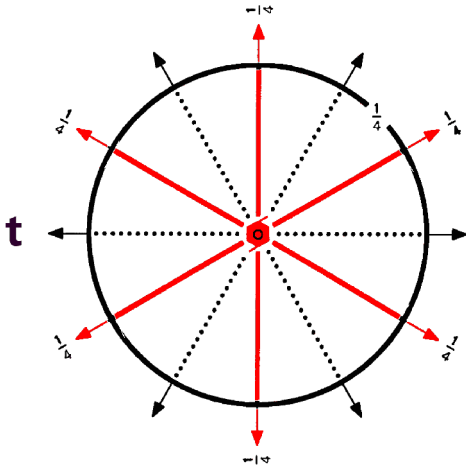

Origin at center ($\bar{3}'m'1$) at $\bar{3}'2/m'c$

Asymmetric unit $y \leq x/2; y \geq -x; 0 \leq z \leq 1/4$

Symmetry operations

- | | | |
|---|---|--|
| (1) 1
(1 0,0,0) | (2) 3^+ 0,0,z
(3_z 0,0,0) | (3) 3^- 0,0,z
(3_z^{-1} 0,0,0) |
| (4) $2'$ (0,0,1/2) 0,0,z
(2_z 0,0,1/2)' | (5) 6^- (0,0,1/2) 0,0,z
(6_z^{-1} 0,0,1/2)' | (6) 6^+ (0,0,1/2) 0,0,z
(6_z 0,0,1/2)' |
| (7) 2 x,x,0
(2_{xy} 0,0,0) | (8) 2 x,0,0
(2_x 0,0,0) | (9) 2 0,y,0
(2_y 0,0,0) |
| (10) $2'$ x, \bar{x} ,1/4
(2_3 0,0,1/2)' | (11) $2'$ x,2x,1/4
(2_2 0,0,1/2)' | (12) $2'$ 2x,x,1/4
(2_1 0,0,1/2)' |
| (13) $\bar{1}$ 0,0,0
($\bar{1}$ 0,0,0)' | (14) $\bar{3}^+$ 0,0,z; 0,0,0
($\bar{3}_z$ 0,0,0)' | (15) $\bar{3}^-$ 0,0,z; 0,0,0
($\bar{3}_z^{-1}$ 0,0,0)' |
| (16) m x,y,1/4
(m_z 0,0,1/2) | (17) $\bar{6}^-$ 0,0,z; 0,0,1/4
($\bar{6}_z^{-1}$ 0,0,1/2) | (18) $\bar{6}^+$ 0,0,z; 0,0,1/4
($\bar{6}_z$ 0,0,1/2) |
| (19) m' x, \bar{x} ,z
(m_{xy} 0,0,0)' | (20) m' x,2x,z
(m_x 0,0,0)' | (21) m' 2x,x,z
(m_y 0,0,0)' |
| (22) c (0,0,1/2) x,x,z
(m_3 0,0,1/2) | (23) c (0,0,1/2) x,0,z
(m_2 0,0,1/2) | (24) c (0,0,1/2) 0,y,z
(m_1 0,0,1/2) |

Generators selected (1); t(0,0,1); (2); (4); (7); (13)

Positions

	Coordinates		
Multiplicity, Wyckoff letter, Site symmetry			
24 h 1	(1) x,y,z [u,v,w]	(2) \bar{y} ,x-y,z [\bar{v} ,u-v,w]	(3) \bar{x} +y, \bar{x} ,z [\bar{u} +v, \bar{u} ,w]
	(4) \bar{x} , \bar{y} ,z+1/2 [u,v, \bar{w}]	(5) y, \bar{x} +y,z+1/2 [\bar{v} ,u-v, \bar{w}]	(6) x-y,x,z+1/2 [\bar{u} +v, \bar{u} , \bar{w}]
	(7) y,x, \bar{z} [v,u, \bar{w}]	(8) x-y, \bar{y} , \bar{z} [u-v, \bar{v} , \bar{w}]	(9) \bar{x} , \bar{x} +y, \bar{z} [\bar{u} , \bar{u} +v, \bar{w}]
	(10) \bar{y} , \bar{x} , \bar{z} +1/2 [v,u,w]	(11) \bar{x} +y,y, \bar{z} +1/2 [u-v, \bar{v} ,w]	(12) x,x-y, \bar{z} +1/2 [\bar{u} , \bar{u} +v,w]
	(13) \bar{x} , \bar{y} , \bar{z} [\bar{u} , \bar{v} , \bar{w}]	(14) y, \bar{x} +y, \bar{z} [v, \bar{u} +v, \bar{w}]	(15) x-y,x, \bar{z} [u-v,u, \bar{w}]
	(16) x,y, \bar{z} +1/2 [\bar{u} , \bar{v} ,w]	(17) \bar{y} ,x-y, \bar{z} +1/2 [v, \bar{u} +v,w]	(18) \bar{x} +y, \bar{x} , \bar{z} +1/2 [u-v,u,w]
	(19) \bar{y} , \bar{x} ,z [\bar{v} , \bar{u} ,w]	(20) \bar{x} +y,y,z [\bar{u} +v,v,w]	(21) x,x-y,z [u,u-v,w]
	(22) y,x,z+1/2 [\bar{v} , \bar{u} , \bar{w}]	(23) x-y, \bar{y} ,z+1/2 [\bar{u} +v,v, \bar{w}]	(24) \bar{x} , \bar{x} +y,z+1/2 [u,u-v, \bar{w}]
12 g .m'	x,2x,z [u,2u,w]	2 \bar{x} , \bar{x} ,z [2 \bar{u} , \bar{u} ,w]	x, \bar{x} ,z [u, \bar{u} ,w]
	\bar{x} ,2 \bar{x} ,z+1/2 [u,2u, \bar{w}]	2x,x,z+1/2 [2 \bar{u} , \bar{u} , \bar{w}]	\bar{x} ,x,z+1/2 [u, \bar{u} , \bar{w}]
	2x,x, \bar{z} [2u,u, \bar{w}]	\bar{x} ,2 \bar{x} , \bar{z} [\bar{u} ,2 \bar{u} , \bar{w}]	\bar{x} ,x, \bar{z} [\bar{u} ,u, \bar{w}]
	2 \bar{x} , \bar{x} , \bar{z} +1/2 [2u,u,w]	x,2x, \bar{z} +1/2 [\bar{u} ,2 \bar{u} ,w]	x, \bar{x} , \bar{z} +1/2 [\bar{u} ,u,w]
12 f m..	x,y,1/4 [0,0,w]	\bar{y} ,x-y,1/4 [0,0,w]	\bar{x} +y, \bar{x} ,1/4 [0,0,w]
	\bar{x} , \bar{y} ,3/4 [0,0, \bar{w}]	y, \bar{x} +y,3/4 [0,0, \bar{w}]	x-y,x,3/4 [0,0, \bar{w}]
	y,x,3/4 [0,0, \bar{w}]	x-y, \bar{y} ,3/4 [0,0, \bar{w}]	\bar{x} , \bar{x} +y,3/4 [0,0, \bar{w}]
	\bar{y} , \bar{x} ,1/4 [0,0,w]	\bar{x} +y,y,1/4 [0,0,w]	x,x-y,1/4 [0,0,w]

Continued

No. 75.9.394

 $\rho 6_3'/\text{mm}'c$

12 e .2.	$x,0,0 [u,0,0]$	$0,x,0 [0,u,0]$	$\bar{x},\bar{x},0 [\bar{u},\bar{u},0]$
	$\bar{x},0,1/2 [u,0,0]$	$0,\bar{x},1/2 [0,u,0]$	$x,x,1/2 [\bar{u},\bar{u},0]$
	$\bar{x},0,0 [\bar{u},0,0]$	$0,\bar{x},0 [0,\bar{u},0]$	$x,x,0 [u,u,0]$
	$x,0,1/2 [\bar{u},0,0]$	$0,x,1/2 [0,\bar{u},0]$	$\bar{x},\bar{x},1/2 [u,u,0]$
6 d $\text{mm}'2'$	$x,2x,1/4 [0,0,w]$	$2\bar{x},\bar{x},1/4 [0,0,w]$	$x,\bar{x},1/4 [0,0,w]$
	$\bar{x},2\bar{x},3/4 [0,0,\bar{w}]$	$2x,x,3/4 [0,0,\bar{w}]$	$\bar{x},x,3/4 [0,0,\bar{w}]$
4 c $3\text{m}'$.	$0,0,z [0,0,w]$	$0,0,z+1/2 [0,0,\bar{w}]$	
	$0,0,\bar{z} [0,0,\bar{w}]$	$0,0,\bar{z}+1/2 [0,0,w]$	
2 b $\bar{6}\text{m}'2'$	$0,0,1/4 [0,0,w]$	$0,0,3/4 [0,0,\bar{w}]$	
2 a $\bar{3}\text{m}'$.	$0,0,0 [0,0,0]$	$0,0,1/2 [0,0,0]$	

Symmetry of special projections

Along [001] $6\text{m}'\text{m}$	Along [100] $\rho 2\text{mg}$	Along [210] $\rho_{2a^*}2\text{m}'\text{m}'$
Origin at 0,0,z	$\mathbf{a}^* = \mathbf{c}$ Origin at x,0,0	$\mathbf{a}^* = \mathbf{c}/2$ Origin at x,x/2,0